

To prevent accidents and machine damage, read these instructions before installation or use. Use the washer only as instructed in this owner's guide and installation instructions included with your washer. Keep this guide for future reference

## Front-Loading Automatic Washer

### WM 87120 NBL00

## Owner's Guide & Installation Instructions



Use only HE High Efficiency detergent.

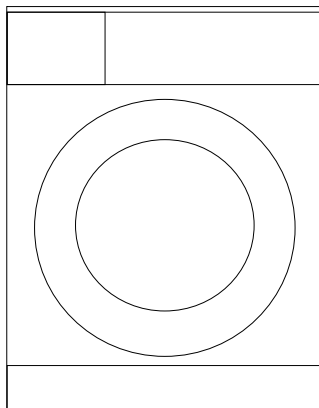

# Blomberg

# Please read this guide first!

Dear Customer,

We hope that your product which has been manufactured in modern facilities and passed through a strict quality control procedure will give you the best results.

Therefore, we advise you to read through this document carefully before using your product and keep it for future reference.

## This guide will...



...help you use your washer in a fast and safe way.

- Please read the guide before installing and starting your washer.
- Particularly follow the instructions related to safety.
- Keep this guide within easy reach. You may need it in the future.
- Please read all additional documents supplied with this washer.

Please note that this owner's guide & installation instructions may be applicable for several other models. Differences between models will be identified in the guide.

## Explanation of symbols

Throughout this guide the following symbols are used:

	<b>CAUTION</b> ⌚ Important information or useful hints about usage.
	<b>WARNING</b> ⌚ Warning for hazardous situations with regard to life and property.
	<b>WARNING</b> ⌚ Warning for electrical shock

If you have questions, call:

Call Center (toll free number)

1-800-459-98-48 (USA)

or send e-mail to:

info@blomberginternational.com

For the list of dealers/retailers, distributors and authorized service agents, visit:

<http://www.blombergappliances.com>

Please fill the information below for future reference.

Model no:

Serial no:

Purchase date:

# TABLE OF CONTENTS

<b>1 Your Washer</b>	<b>5</b>
Overview . . . . .	5
Specifications . . . . .	6
<b>2 Important Safety Instructions</b>	<b>7</b>
<b>3 Installation Instructions</b>	<b>10</b>
The Right Location of Installation . . . . .	10
Installation Clearances . . . . .	10
Allowable Clearances for Undercounter Installation . . . . .	11
Allowable Clearances for Closet Installation . . . . .	11
Stacked Installation . . . . .	11
Removing packaging reinforcement . . . . .	11
Removing shipping bolts . . . . .	12
Levelling the washer . . . . .	12
Electrical Connection . . . . .	13
Power supply and circuit . . . . .	14
Water Supply Connection . . . . .	14
Drainage . . . . .	15
Installation Checklist . . . . .	16
Transportation . . . . .	16
Disposal Information . . . . .	17
Appliance Disposal . . . . .	17
<b>4 Operating Instructions</b>	<b>18</b>
First Use . . . . .	18
Laundry Tips . . . . .	18
Preparing the laundry . . . . .	19
Loading the washer . . . . .	20
Detergent Use . . . . .	20
Detergent Quantity . . . . .	21
Detergent Dispenser . . . . .	21
Water Consumption . . . . .	23

## TABLE OF CONTENTS

<b>5</b>	<b>Selecting a Program and Operating Your Washer</b>	<b>24</b>
	Control panel . . . . .	24
	Display symbols . . . . .	25
	Turning the washer on . . . . .	25
	Program cycle selection . . . . .	25
	Wash Cycles . . . . .	26
	Additional programs . . . . .	26
	Special programs . . . . .	27
	Temperature selection . . . . .	27
	Spin Speed selection . . . . .	27
	Program Cycle Selection Table . . . . .	28
	Auxiliary functions . . . . .	30
	Time display . . . . .	31
	Starting the Program . . . . .	32
	Progress of program . . . . .	32
	Changing the selections after the program has started . . . . .	32
	Switching the washer to standby mode . . . . .	32
	Child-proof lock . . . . .	33
	Ending the program through canceling . . . . .	34
	End of program . . . . .	34
<b>6</b>	<b>Preparation</b>	<b>35</b>
	Starting . . . . .	35
	Canceling a program . . . . .	35
	Adding more laundry . . . . .	36
	Re-spinning the laundry . . . . .	37
	After the program is finished . . . . .	37
<b>7</b>	<b>User maintenance instructions</b>	<b>38</b>
	Cleaning detergent dispenser . . . . .	38
	Cleaning the door seal . . . . .	38
	Cleaning the outer cabinet and control panel . . . . .	39
	Cleaning the water inlet strainers . . . . .	39
	Cleaning the drain pump filter . . . . .	40
	Descaling the washer . . . . .	41
<b>8</b>	<b>Troubleshooting</b>	<b>42</b>
<b>9</b>	<b>WARRANTY STATEMENT FOR THE BLOMBERG CLOTHES WASHERS</b>	<b>52</b>
<b>10</b>	<b>HOW TO GET SERVICE</b>	<b>53</b>

# 1 Your Washer

## Overview

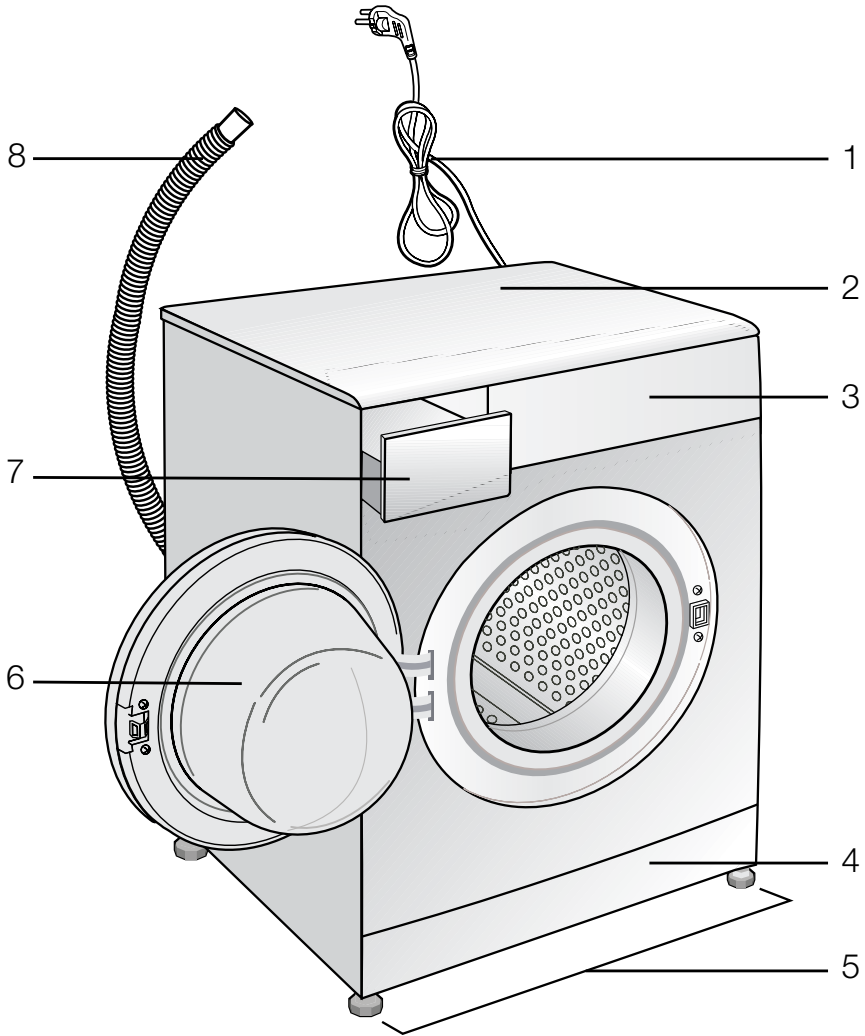

1 - Power Cord

2 - Top Lid

3 - Control Panel

4 - Filter Cap

5 - Height-adjustable Feet

6 - Loading Door

7 - Detergent Dispenser

8 - Drain Hose

## Your Washer

### Specifications

	Front Loading Automatic Washer
Models	WM 87120 NBL00
Height (in) / (cm)	33.1 / 84
Width (in) / (cm)	23.6 / 60
Depth (in) / (cm)	23.2 / 59
Net Weight (lbs) / (kg)	168 / 76
Electricity (V/Hz.)	208-240 / 60
Total Current (A)	10
Total Power (W)	2000-2350
Spinning cycle (rpm max.)	1200
Water pressure (psi) / (bar)	15-145 psi / (1-10) bar
Drain height (ft.) / (m.)	4.9 / 1.5
Wash capacity (cu. Ft.)	2.15 cu. Ft.
Dry Load Capacity (lbs)/(kg)	17.6 / 8

Specifications of this appliance may change without notice to improve the quality of the product. Figures in this guide are schematic and may not match your product exactly. Values stated on the washer labels or in the documentation accompanying it are obtained in laboratory in accordance with the relevant standards. Depending on operational and environmental conditions of the appliance, these values may vary.

## 2 Important Safety Instructions



### WARNING

ⓘ To reduce the risk of fire, electric shock or injury to persons while using your appliance follow basic safety precautions, including the following:

- Read all instructions before using the washer.
- Do not wash articles that have been previously cleaned in, washed in, soaked in, or spotted with gasoline, dry-cleaning solvents, or other flammable or explosive substances (acetone, alcohol, kerosene, some liquid household cleaners, some spot removers, turpentine, waxes and wax removers) as they give off vapors that could ignite or explode.
- Do not add gasoline, dry-cleaning solvents, or other flammable or explosive substances to the wash water. These substances give off vapors that could ignite or explode.
- Under certain conditions, hydrogen gas may be produced in a hot-water system that has not been used for 2 weeks or more. **HYDROGEN GAS IS EXPLOSIVE.** If the hot-water system has not been used for such a period, before using a washing machine, turn on all hot-water faucets and let the water flow from each for several minutes. This will release any accumulated hydrogen gas. As the gas is flammable, do not smoke or use an open flame this time.
- Do not allow children to play on or in the appliance. Close supervision of children is necessary when the appliance is used near children.
- Before the appliance is removed from service or discarded, remove the door and the power cord / main plug to prevent accidents.
- Do not reach into the appliance if the drum is moving. Wait until the drum has completely stopped before opening the door.
- Do not install or store this appliance where it will be exposed to the weather and direct sunlight.
- Do not tamper with controls.
- Do not repair or replace any part of the appliance or attempt any servicing unless specifically recommended in the user-maintenance instructions or in published user-repair instructions that you understand and have the skills to carry out.
- This appliance must only be used for the purpose of washing, rinsing and spinning machine-washable items using laundry additives that are suitable for use in washers. The appliance manufacturer cannot be held responsible for damage caused by improper or unintended use of the appliance.
- Only detergents, softeners and additives suitable for use in HE (High-efficiency) washers may be used. Always follow the instructions and information given by the laundry detergent manufacturers when using these products.



Use only HE High Efficiency detergent.

- Always follow the fabric care instructions of garment manufacturers.
- Do not touch the door glass while washing at high temperatures. Danger of burning!
- Do not sit on top of the washer.
- Do not climb onto the washer.
- Destroy the shipping carton, plastic bag and other packing materials after the washer is unpacked. Keep children away from these packing materials. Danger of suffocation from plastic sheets and cartons!

## Important Safety Instructions

- Do not mix chlorine bleach with ammonia or acids such as vinegar and/or rust remover when washing. This mixture can produce hazardous fume which may cause death.
- Do not operate this appliance if it is damaged, malfunctioning, partially disassembled, or has missing or broken parts, including a damaged cord or plug.
- Store laundry detergents and additives in a cool, dry place out of children's reach due to danger of chemical poisoning and skin irritation. Follow the manufacturers' instructions when using laundry products.
- Do not machine wash fiberglass materials. Small particles can stick to fabrics washed in following cycles and may lead to skin irritation.
- Do not wash items stained with vegetable oil, cooking oil or petroleum. These items may contain some flammable oils after laundering and the fabric may smoke or catch fire by itself.
- Be sure to unplug the power cable before attempting maintenance or cleaning of your appliance to minimize the risk of electric shock. Always unplug the cable by grasping the plug, not the cord.
- Do not use wet hands when plugging/unplugging the power cable.
- Check the water inlet and drain hose connections regularly for any leakage. Hoses should be replaced every 5 years.
- Do not leave the washer door open to prevent children hurt themselves by hanging on the door or going inside the drum.
- Be careful when the appliance is draining hot water. Danger of burning!
- At the end of a washing day, turn off the water faucets to prevent any leakage that may occur due to a faulty condition of the appliance.
- Check the appliance and inlet hose connections for water leakage after each use. If there is leakage, turn off the appliance and water faucets and call service.
- Do not machine wash items having large or heavy metal parts such as buttons or buckles. These items could severely damage the appliance.
- Always be sure to empty all foreign materials from the pockets of your clothing as small items such as coins, pins etc could severely damage the appliance.
- Do not install and operate the appliance in places exposed to temperatures below freezing. Frozen water may cause severe damage by bursting hoses and pump.
- Make sure that shipping bolts are removed before you operate the washer. If service is required as a result of not removing the bolts, it will not be covered by the warranty.
- Make sure that the wash drum is empty before you load the washer.
- Do not store and use any flammable and combustible substances such as lint, paper and chemicals near the appliance.
- Always follow the manufacturer's instructions when you are using a descaling agent. Be sure that descaling agent contains rust-protective materials and rinse the washer a few times thoroughly after the descaling process (See, Descaling the washer).
- Install and operate the washer on a solid floor to prevent vibration or movement. It is not recommended to install and operate the washer on wooden floor or on a carpet.
- The rated voltage of your washer is 208/240V, so it should not be directly connected to the mains of 110/120V. A special junction box will be provided and used for the mains connection (See, Installation Instructions for Grounding Instructions and Requirements).
- If an abnormal sound is heard during the washer operation, refer to the "Troubleshooting" of this guide.
- Call service for checking any possible damage or fault if the appliance is dropped or bumped.
- The end of drain hose should not contact the discharge water in any way as this might cause siphoning of water.
- Always leave the property after checking that the wash cycle is completed and the washer is turned off.
- Damaged or worn power cords and plugs must only be replaced by a Blomberg Service technician.



## Important Safety Instructions

- Never use an extension cord or adapter to connect the appliance to the electrical power due to the risk of electric shock and/or fire.
- All broken and faulty components, panels and parts must only be replaced with original Blomberg spare parts by a Blomberg Service technician.
- Do not force the washer door open when it is locked. The door must be closed any time during the programme cycle.
- Do not use fabric softeners or products to reduce static unless recommended by the manufacturers of the fabric softener product.
- Check the drain pump filter occasionally to remove coins, buttons and such small objects.
- Always drain off the water completely before cleaning the pump filter, before transporting the washer, when there is a danger of frost and when there is a power failure (For emergency draining, See User maintenance instructions).
- Always be sure that the washer has been properly installed by licensed personnel, water and electrical connections and grounding conform to all relevant codes and requirements.
- This manual does not cover every possible condition and situation that may occur. Use common sense and caution when installing, operating, and maintaining any appliance.

### SAVE THESE INSTRUCTIONS

Always follow the instructions on this user guide. If you aren't sure how to perform them, please call Customer Service for assistance and scheduling service.



### WARNING

- ⚠ This product may contain chemicals known to the state of California to cause cancer or birth defects or other reproductive harm.

### 3 Installation Instructions

Read this first !

This washer can be individually installed in free-standing and built-in installations. You can also install your washer with your dryer as a free-standing or built-in pair. Before you install your appliance, read the following instructions completely and carefully:

- Save these instructions for future reference.
- This appliance must be properly installed and grounded by qualified and skilled technicians in accordance with all local codes and ordinances and the latest edition of the National Electrical Code, ANSI/NFPA 70.
- Proper installation of this appliance is the responsibility of the owner and failure due to improper installation is not covered by the warranty.

#### The Right Location of Installation

You can install your washer in a basement, closet or in a laundry room if the location has proper drainage, plumbing and power supply system. Always follow these instructions for installation:

- Do not install or store this appliance where it will be exposed to the weather, rain, damp places, water and direct sunlight. The ambient temperature must be higher than 60°F (15.6°C) for proper operation. Installation location must have the proper ventilation.
- Do not store and use any flammable and combustible substances such as lint, paper, curtains, gasoline, coal and liquid or vapor chemicals near the appliance.
- Install and operate the washer on a strong solid concrete floor to prevent vibration, noise or movement in case of load unbalance. The floor must have sufficient load carrying capacity and the washer must be leveled properly before the operation.
- It is not recommended to install and operate the washer on a wooden floor or soft floor. If you have to install your washer on a wooden or frame construction floor, the floor must be reinforced properly and the washer must be located in the corner of the room if possible.
- Never place your washer on a carpet. This prevents air circulation. The electrical components of the machine may overheat and cause damage.
- Do not stand appliance on the power cable.
- Do not install and operate your washer in ambient temperatures lower than 32°F (0°C). Controls may stop working properly in such condition.
- If there is danger of frost, drain all remaining water in pump and hoses since it may freeze and cause damage by bursting them (see "Cleaning the drain pump filter").

#### Installation Clearances

##### CAUTION



- The installation location must be large enough for the washer door to be fully opened for loading.
- The installation location must be large enough for ease of operation, maintenance and service.
- Ensure there is min 1/2" of clearance on each side of the washer to allow slight side ways movement during washing and spin drying.

## Installation Instructions

### Allowable Clearances for Undercounter Installation

The dimensions are for the recommended spacing. Counter depth should be 23.5-24.5" (60-62 cm).  
Custom undercounter installation – Washer only

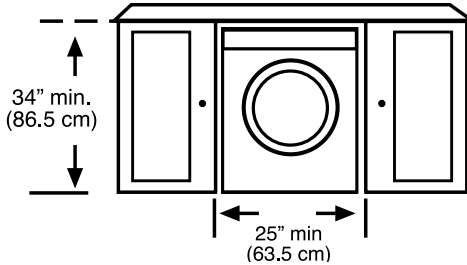

Minimum counter width should be 50" (127 cm) for a pair of Blomberg washer & dryer.  
Custom undercounter installation – Washer & Dryer

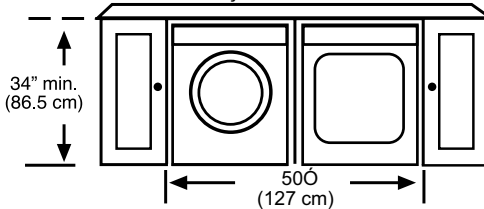

### Allowable Clearances for Closet Installation

When installed in closet (washer only/washer dryer stacked) :  
Sides, Rear, Front 1/2 in. (1.27 cm), Top= 1 in. (2.54 cm)

Closet door ventilation requirement: A louver having minimum 23 in<sup>2</sup> (148 cm<sup>2</sup>) air opening located at 3 in (7.62 cm) from the bottom of closet door.

### Stacked Installation

You can stack your Blomberg washer and dryer (model no: DV 16540 NBL00) by using a special stacking kit (Part No.2967100100). If necessary, consult your dealer or technical service for supplying the stack kit. In stacked closet installation, following configuration is necessary:

A louver having minimum 23 in<sup>2</sup> (148 cm<sup>2</sup>) air opening located at 3 in (7.62 cm) height from the bottom of closet door (for washer) & A louver of minimum 46 in<sup>2</sup> (297 cm<sup>2</sup>) air opening located at 3 in (7.62 cm) distance from the top of closet door (for dryer).

### Removing packaging reinforcement

Tilt the washer to remove the packaging reinforcement. Remove the packaging reinforcement by pulling the ribbon.

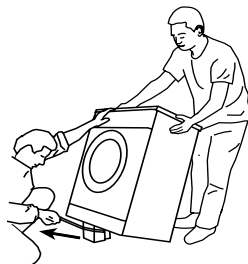

## Installation Instructions

### Removing shipping bolts



#### WARNING

⚠ Shipping bolts must be removed before operating the washer! Otherwise, the appliance will be damaged seriously!

1. Loosen all the bolts with a spanner until they rotate freely ("C")

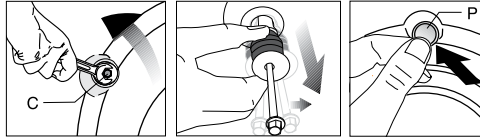

2. Remove the shipping bolts by turning them gently.
3. Bolt hole covers (supplied in the bag with the owner's guide) are fitted into the holes on the rear panel with a special lock mechanism. To fit the cover, first insert it into the hole and then rotate it counterclockwise with a screwdriver until it is locked. To unlock, apply the procedure in reverse.

#### CAUTION



⚠ Keep the shipping bolts in a safe place to reuse when the clothes washer needs to be moved again in the future.  
⚠ Never move the appliance without shipping bolts properly fixed in place!

### Levelling the washer



#### WARNING

⚠ Do not use any tools to loosen the lock nuts. Otherwise, they can be damaged.

1. Manually (by hand) loosen the lock nuts on the feet.
2. Adjust them until the washer stands level and firmly.
3. Important: Tighten all lock nuts up again.

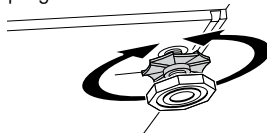

## Installation Instructions

### Electrical Connection Grounding Instructions

This appliance must be grounded. In the event of malfunction or breakdown, grounding will reduce the risk of electric shock by providing a path of least resistance for electric current. This appliance is equipped with a cord having an equipment-grounding conductor and a grounding plug. The plug must be plugged into an appropriate outlet that is properly installed and grounded in accordance with all local codes and ordinances and the latest edition of the National Electrical Code, ANSI/NFPA 70.

#### WARNING

- ⊘ Improper connection of the equipment-grounding conductor can result in a risk of electric shock. Check with a qualified electrician or serviceman if you are in doubt as to whether the appliance is properly grounded.
- ⊘ Do not modify the plug provided with the appliance – if it will not fit the outlet, have a proper outlet installed by a qualified electrician.
- ⊘ Be sure that the power cord is always accessible by the user after the appliance is installed.
- ⊘ Never use an extension cord or adapter to connect the appliance to the electrical power due to the risk of electric shock and/or fire.
- ⊘ It is the personal responsibility and obligation of the appliance owner to provide a proper and grounded outlet installed by a qualified electrician.
- ⊘ Never use a damaged power cord since there is a risk of electric shock and/or fire.
- ⊘ The damaged power cord must be replaced by a qualified electrician as soon as possible.
- ⊘ Electrical supply voltage must conform to the voltage specifications (208-240V, 60Hz) located on the appliance. For this purpose, a junction box (as seen in picture below) must be obtained. Junction box is supplied with Blomberg Clothes Dryer (model no: DV 16540 NBL00) and it works as a voltage converter from 110/120V to 208/240V between the mains and appliance.

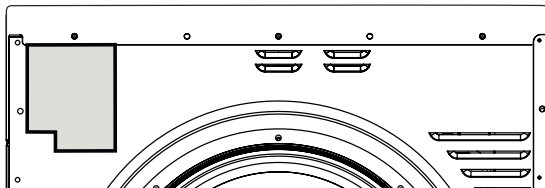

- ⊘ Only one appliance must be connected to a properly grounded individual branch circuit outlet.
- ⊘ Be sure to unplug the power cable before attempting maintenance or cleaning of your appliance to minimize the risk of electric shock. Always unplug the cable by grasping the plug, not the cord.
- ⊘ Do not use wet hands when plugging/unplugging the power cable.

## Installation Instructions

### Power supply and circuit

Connect the clothes washer to the junction box supplied. Junction box must be connected to an earthed outlet protected by a fuse of suitable capacity.

Important:

- Mains connection should comply with national regulations.
- The voltage and maximum total current are specified in the section "Specifications".
- The appliance must not be directly connected to the mains in case of absence of junction box.
- Connection via extension cords or multi-plugs should not be made.

#### WARNING



- A damaged power cable must be replaced by a qualified electrician.
- The appliance must not be operated unless it is repaired! There is the risk of electric shock!

15 Amp. Fuse or circuit breaker, 208-240 volt, 60 Hz, grounded, alternating current  
Properly grounded 3-prong receptacle and junction box to be located so the power supply cords are accessible when the washer is in installed position.

### Water Supply Connection

Your washer comes with both cold and hot water connections. Connect the blue marked cold water supply hose to the cold water inlet valve/faucet and the red marked hot water intake hose to the hot water inlet valve/faucet. Screw the connecting bolts by hand and tighten the connection properly using a plier. Over tightening may cause damage on bolted connection.

#### WARNING



- Be sure that the water connection of this washer is handled by a qualified service technician or a plumber.

The washer has two bolted  $\frac{1}{2}$ " water supply hoses and  $\frac{3}{4}$ " female hose connections that can be connected to  $\frac{3}{4}$ " hot and cold water faucets.

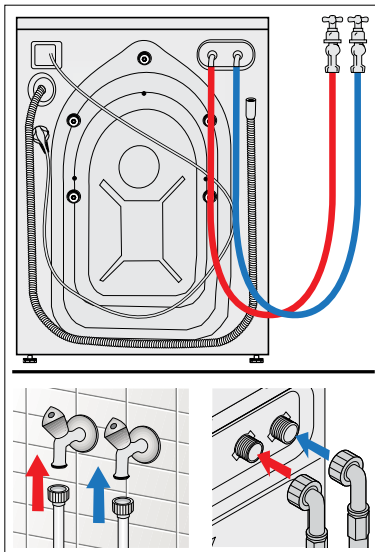

## Installation Instructions

### WARNING



- Be sure that there are rubber seals located on the hose connections. These seals and adjustable bolts ensure a safe connection without leaking. After the water connection is done, turn on both water faucets slowly and completely to check any water leaks.
- Be sure that water supply hoses are not crushed and they have no kinking, bulges or cuts before the water connection.

The water pressure must be between 15-145 psi (1-10 bar) for the proper operation of this washer. 1 bar corresponds to more than 2.1 US gallons (8 liters) per minute flow rate with a fully open faucet. Water inlet hoses and valves should withstand a water pressure of 145 psi (10 bar) at maximum. If the pressure is higher than 145 psi, a pressure-reducing valve must be installed before the water inlet. If the water pressure is lower than 15 psi (1 bar), water fill time may extend or water inlet valve may shut off completely.

- Hot water supply temperature must not exceed 140°F (60°C). (Ideally 120°F (48°C))
- Do not connect the washer to an unpressurized water boiler since water pressure may not be adequate for proper operation.
- Do not remove the filters located on the water supply hoses (on faucet/hose and hose/inlet valve connections).
- Always use genuine "Blomberg" water supply hoses when connecting with this washer. Old or worn-out hoses must not be reused. It is not advised to extend inlet or drain hoses, if necessary consult your dealer or technical service about hose extensions.
- Hot and cold water faucets must always be easily accessible to the user.
- At the end of a washing day, turn off water faucets to prevent any leakage or water damage that may occur due to a faulty condition of the appliance.
- Check the appliance and inlet hose connections for water leakage after each use. If there is leakage, turn off the appliance and water faucets and call service.
- Check the water inlet and drain hose connections regularly for any leakage. Hoses should be replaced every 5 years.
- If there is no hot water supply, hot water valve must be connected to a cold water faucet nevertheless. Both water valves should be connected to water supply for proper operation of your washer.

## Drainage

### WARNING



- Drain hose should not be bent. Be sure that there are no kinks or cuts on it.
- Drain hose outlet must not contact the drained water.

Drain hose may be connected into a sink, into the drain of a sink, to a standpipe and floor drain.

- When connecting into a sink, the drain hose should be placed at the edge of the sink and secured with the hose guide supplied by the manufacturer. Additionally, the guided hose may be tied to the water faucet with a strap for extra security.
- Drain hose may be connected into the drain of a sink. Be sure that the connection is safe and not leaking. An additional clip etc can be used for safe connection.
- Drain hose may also be connected to a minimum 1.26 in (32 mm) diameter stand pipe.

## Installation Instructions

- Be sure to secure the drain hose tightly to the pipe (stand pipe, drain pipe/edge of the sink) with a strap etc.
- The hose should be placed between 16 and 39 in. (40 and 100 cm) from the floor level
- If you have floor drain system, you can place the drain hose in the hole located on the floor.

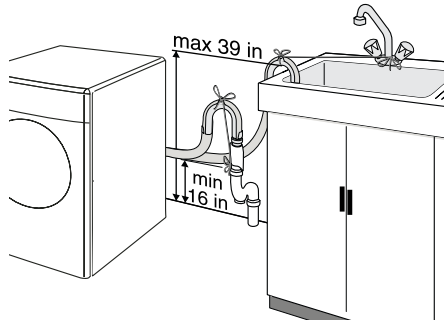

### Installation Checklist

- Water inlet hoses and accessory bags must be removed from the wash drum.
- Transportation/shipping bolts must be removed.
- Washer must be properly leveled by using the adjustable feet.
- Water inlet hoses are connected to the water faucets, secured and checked for any leaks by turning on both faucets.
- Drain installation is done properly and drain hose is checked and secured to prevent any flooding.
- Washer is connected the junction box which is plugged to a properly grounded live mains outlet.
- Be sure that power outlet, water faucets and drain outlet must be always accessible to the user.

### Transportation

Before you transport the washer, you should carry out the following:

1. Turn off both water faucets.
2. Before you disconnect the water inlet hoses, decrease the pressure inside hoses by turning on the washer choosing any wash program. As soon as the Start/Pause/Cancel led starts blinking, turn off the appliance. You may securely disconnect inlet hoses without any water gush.
3. Disconnect the drain hose and hang it on the back plate by inserting into the holder plastic brackets.
4. Unplug the power cord and hang it on the back plate by inserting into the holder plastic brackets.
5. Remove bolt hole covers and reinstall shipping bolts to their places. You can apply the procedure in chapter "Removing shipping bolts" in reverse to accomplish this.
6. Be sure that rubber bushes are properly located in holes and bolts are screwed back tightly for secure transportation of the appliance.



## Installation Instructions

### Disposal Information

#### Packing Disposal



#### WARNING

- Packing materials of the appliance are potentially dangerous for children. Materials such as plastic bags, films or wrappings must be kept away from children or disposed properly to prevent the danger of suffocation.



#### CAUTION

- Packing materials are made of biodegradable and recyclable substances. You should consult your local authority or dealer about the environmental-friendly disposal of the packaging of your appliance.

### Appliance Disposal



#### WARNING

- Be sure to unplug the power cable, cut off the plug and disable the door lock before you dispose your old appliance. Otherwise there is a risk of injury for children and pets.



#### CAUTION

- Old appliances contain many recyclable parts. You should consult your local environmental authority about a proper disposal. A proper disposal enables recycling therefore protects the environment.

# 4 Operating Instructions

## First Use



### WARNING

ⓘ To reduce the risk of fire, electric shock, or injury to persons, read the IMPORTANT SAFETY INSTRUCTIONS before operating this appliance.

### Before the first use,

- Be sure that the washer is installed properly by a qualified installer or service technician in accordance with all national and local codes and requirements.
- Read all instructions carefully before using the washer.
- Check that shipping bolts are completely removed.
- Be sure that the location of installation has proper electrical supply voltage (junction box must be used for connecting the washer to the mains) and plumbing system needed for the operation of the appliance.
- Turn on both water faucets and be sure that there are no leaks on hose-faucet connection points or on hoses themselves.



Use only HE High Efficiency detergent.

- Check that the wash drum is empty.
- Turn on the washer, choose “sanitary” cycle on the program selector knob and start the washer as empty and without any laundry additives. When the cycle is finished, your washer is ready for subsequent uses.

## Laundry Tips

### Sorting the laundry

### CAUTION



ⓘ Always follow the fabric care instructions of garment manufacturers. These instructions would give you proper guidance on suitable wash cycles, wash temperatures and bleach usage.

 Normal wash setting	 Permanent Press or Wrinkle Resistant setting	 Gentle/Delicate setting	 Hand wash only	 Do not wash	 Do not wring. Hang dry, drip dry or dry flat
 Maximum water temp. 200F/95C	 Maximum water temp. 160F/70C	 Maximum water temp. 140F/60C	 Maximum water temp. 120F/50C	 Maximum water temp. 105F/40C	 Maximum water temp. 85F/30C
 Anti bleach when needed	 Only non-chlorine bleach	 Do not Bleach	 This symbol indicates the fabric should be dry cleaned only		

## Operating Instructions

### CAUTION



- ⓘ Wash the items which are care labeled as “machine-washable”. Do not machine wash items that are having  symbol on fabric care label.
- ⓘ Sort the laundry according to the following fabric types, color groups and wash them separately:

- White and color fast fabrics
- Non-fast, colored fabrics
- Permanent press items(mens shirt, dress pants, poly-cotton blends)
- Delicate fabrics (silk, rayon etc.)
- Woolens (only wash woolens that are labeled “machine washable” or “hand washable”
- Hand knits (They should be placed inside out in the washer)

### CAUTION



- ⓘ Do not wash dark colors with light colors and whites. Color items may bleed and white and light colored items may be discolored. Avoid extended contact of damp clothes before or after washing to prevent dye transfer.
- ⓘ Wash heavily and lightly soiled items separately.
- ⓘ Lint producers (towels, linen etc) and lint collectors (easy care, permanent press) should be washed separately. Lint producers should be washed inside-out.

### Preparing the laundry

- Items of laundry with metal parts (e.g. underwire bras, belt buckles, metal buttons) will damage the washer. Remove metal parts or place the items in a cloth bag, pillow case, or something similar.
- Remove any non-washable items and accessories from laundry before washing.
- Empty pockets, remove all foreign objects (e.g. coins, pens, paper clips). If possible: Turn pockets inside out and brush.
- Place small items of laundry (e.g. tights) in a cloth bag, pillow case or something similar. This can also help you to avoid searching for lost socks.
- Handle curtains special care. Remove non-stainless curtain runners and lead tape. Place runners that can't be removed in a cloth bag, pillow case or something similar.
- Heavy stains should be pretreated with soapy water appropriately before washing (Do not rub or scratch the stained area). If in doubt, check with a chemist or dry-cleaner.
- Use only dyes/discoloring and anti-scaling agents suitable for machine wash. Make sure to follow the instructions on the package.



### WARNING

- ⓘ Wash jeans, delicates, pants and sweat-shirts inside-out.

## Operating Instructions

### Loading the washer

Maximum load capacity depends on the fabric type of laundry, soiling amount of laundry and program cycle you wish to use.

#### CAUTION



- ⓘ Do not exceed the maximum load capacity of the selected program cycle. Washing results are adversely affected by an overloaded drum. Overloading may also cause wrinkling and abrasion on clothes.

Make sure power button is off before loading the washer. To load the washer,

- Pull the door handle.
- Place laundry items loosely in the drum.
- Mix small and large items for an even load distribution. Large items should be loaded first. Large items should not be more than half of the total wash load.
- If you put a wash bag or net which is filled with small items in the drum, put an additional wash bag to prevent load unbalance. Both wash bags should have the same amount of items to provide an even load distribution.
- Before washing a single or a few items such as a pillow, a teddy bear, a single or a pair of shirts, sweat shirts etc, put some additional items in the drum for better load distribution and spinning.
- Make sure that there is no clothing obstructing the door or caught between the door and rubber seal.
- Push the loading door firmly shut until you hear it lock into space (especially if you load the washer with full load or big items).
- In case the door is not locked, “door” expression will appear on the screen. In that case, door should be opened and closed again firmly.
- If the door is not closed completely, the machine will not start. This is a safety precaution. The front door is locked until end of the washing program and it can not be opened until the door icon on LCD is off following the end of the program.
- Unload the washed items just after the program cycle has finished. Delay of unloading may cause wrinkling and unwanted odor on laundry.
- Check to see any small metal items such as pins, coins etc left in rubber seal while unloading the washer. Any residual metal items may cause rusting on the rubber seal.
- If there is any water left in rubber seal, remove with a soft cloth.

### Detergent Use About Detergent

#### CAUTION



- ⓘ Your washer is designed to use only HE (high efficiency) detergents. You should always look for the following symbol on the label of detergents:

If you use a non-HE detergent with this washer, high sudsing will occur. High sudsing will decrease tumble action effectiveness, washing and rinsing performance worsen. Suds may flow out of detergent dispenser giving damage to your washer.

#### CAUTION



- ⓘ The detergents labeled as “HE compatible” may also lead to high sudsing and inefficient tumble action. Don't use such detergents.

## Operating Instructions



Use only HE High Efficiency detergent.

Always follow the instructions and information given by laundry detergent manufacturers when using these products.



### WARNING

- ⦿ Store laundry detergents and additives in a cool, dry place out of children's reach due to danger of chemical poisoning and skin irritation.

### Detergent Quantity

The amount of washing detergent to use depends on the amount of laundry, the degree of soiling and water hardness.

For small amounts of laundry or only slight soiling use accordingly less detergent.

Too much detergent causes an excessive amount of foaming, bad washing and rinsing results and a strain on water resources.

Too little washing detergent causes laundry to turn grey and calcification of the machine.

Recommended amount of powder detergent is max. 1/3 cup (80 ml). Recommended amount of liquid detergent is max. 1/4 cup (60 ml).

#### Light soiling

No visible stains or soiling

#### Normal soiling

A few visible light stains or soiling

#### Heavy soiling

Highly visible stains or soiling

### Detergent Dispenser

Detergent dispenser of your washer has three separate compartments for main wash detergent, fabric softener and liquid bleach. Each of these laundry additives are automatically dispensed at appropriate time during wash program.

### CAUTION



- ⦿ Do not put laundry additives directly in the wash drum. Always use the detergent dispenser.
- ⦿ After adding laundry additives do not close the drawer too quickly. This may cause early dispensing of the additives thus poor wash results and fabric damage.
- ⦿ Do not open the drawer during wash program (except for addition of liquid main wash detergent at the beginning of main wash water intake).

## Operating Instructions

Dispenser compartments are as follows:

- left compartment numbered as "II" (main wash compartment)
- middle compartment marked as "☼" (liquid fabric softener compartment)
- right compartment numbered as "I" (liquid chlorine bleach compartment)

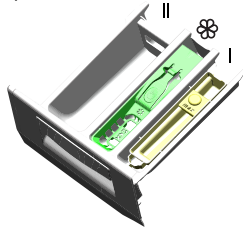

### (II) Main Wash Detergent Compartment

Add HE (High efficiency) powder detergent to this compartment numbered as "II" before starting the wash program.

Use the detergent manufacturer's dosing cup and follow the instructions on the package.

If you use a liquid detergent, be sure to use a HE (High efficiency) detergent and add detergent directly to main wash compartment before operating your washer. If you observe liquid detergent stains on washed items, it is recommended for subsequent wash cycles that you should add liquid detergent during first water intake.



Use only HE High Efficiency detergent.

Color-safe bleach in powder or liquid form may be added into main wash detergent compartment with main wash detergent. Be sure to use main wash detergent and color-safe bleach in same form (either powder or liquid) when adding into main wash compartment.

### Liquid Fabric Softener Compartment

Add the recommended amount of liquid fabric softener to the middle compartment marked as "☼" and dilute it with warm water to the maximum fill line.



#### CAUTION

- Especially concentrated fabric softeners must be diluted with warm water otherwise siphon may be clogged in time.

Do not fill the fabric softener above the maximum fill line as any excess amount will mix into the wash water and you will have to re-fill the compartment. Do not pour the softener directly onto laundry, it may cause stains.

Liquid fabric softener is automatically dispensed during the final rinse of wash program.

## Operating Instructions

### Using liquid detergents

#### If the product contains a liquid detergent cup:

- Make sure that you have placed the liquid detergent cup in compartment nr. "2".
- If the liquid detergent has lost its fluidity, dilute it with water before putting in the detergent cup.



#### If the product does not contain a liquid detergent cup:

- Do not use liquid detergent for the prewash in a program with prewash.
- Liquid detergent stains your clothes when used with Delayed Start function. If you are going to use the Delayed Start function, do not use liquid detergent.

### (I) Liquid Chlorine Bleach Compartment

Add liquid chlorine bleach to the right compartment numbered as "1". Measure 1/3 cup (80 ml) of bleach and pour it into the special container located in the right compartment of the dispenser. This container ensures dispensing and dilution of bleach during the first rinse of wash cycle. There is a maximum fill line on the container. Do not exceed the maximum fill line to prevent early dispensing. Early dispensing may damage your clothes.

#### CAUTION



- Be sure that bleach container is present in the right compartment of dispenser before you add liquid bleaching agent. You may remove bleach container if you would not use bleach. However do not put any other laundry additives to the empty compartment.
- Be sure to choose extra rinse option if you are using bleach in wash program. Bleach must be rinsed from laundry properly otherwise it may cause skin irritation.

Bleach is automatically dispensed and diluted during the first rinse of wash program.

#### WARNING



- Bleach may only be used in Regular/Cotton and Permanent Press cycles. Don't use bleach with delicates, hand washables or wools, it will lead to clothes damage.

### Water Consumption

Your clothes washer automatically adjusts the water consumption according to load amount. This feature ensures high wash performance results with efficient water and energy consumption.

## 5 Selecting a Program and Operating Your Washer

### Control panel

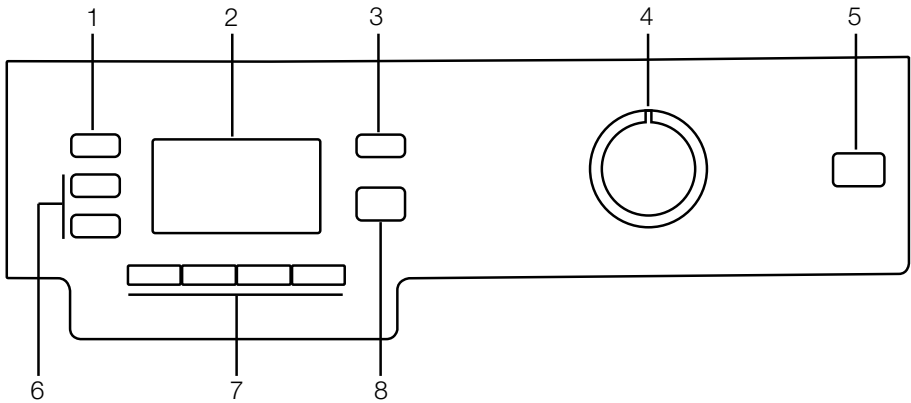

- 1 - Spin Speed Adjustment Button
- 2 - Display
- 3 - Temperature Adjustment Button
- 4 - Program Selection Knob
- 5 - On/Off Button
- 6 - Time Delaying Button (+/-)
- 7 - Auxiliary Function Buttons
- 8 - Start/Pause/Cancel Button



# Selecting a Program and Operating Your Washer

## Display symbols

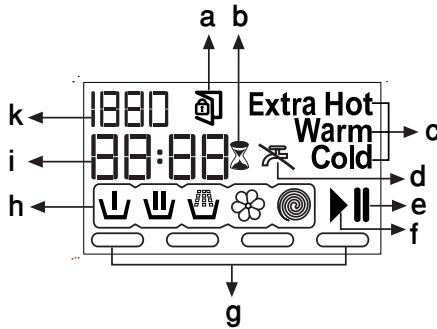

- a - Door Locked Symbol
- b - Time Delaying Symbol
- c - Temperature Indicator
- d - Water cut-off symbol (According to your machine's model)
- e - Standby Symbol
- f - Start Symbol
- g - Auxiliary Function Symbols
- h - Program Indicator Symbols (Soak/main wash/rinse/softener/spin)
- i - Remaining Time and Delaying Time Indicator
- k - Spin Speed Indicator

## Turning the washer on

Plug in your washer. Turn the tap on completely. Check if the hoses are connected tightly. Place the laundry in the washer. Add detergent and softener. Press the "On/Off" button.

## Program cycle selection

Select the appropriate program from the program table according to type, amount and degree of soiling of the laundry and washing temperatures.

Turn the Program Selection Knob to the program mode that you wish to wash your laundry.

The recommended temperature and spin speed for the selected program appear. Press "Start/Pause/Cancel" button to start the program.

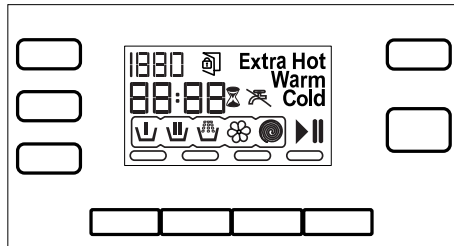

## Selecting a Program and Operating Your Washer

### Wash Cycles

Depending on the type of fabric, the following main programs are available. Each of these main programs comprise of a complete washing process, including washing, rinsing and, if required, spin cycles.

#### WARNING



- ⓘ When selecting the program you are going to use, always consider type of fabric, color, degree of soiling and permissible water temperature.
- ⓘ Always select the lowest required temperature. Higher temperature means higher power consumption.

#### CAUTION



- ⓘ For further program details, see “Program Cycle Selection Table”

#### •Regular/Cotton

You can wash your durable white and colorfast items with this cycle. Washes with vigorous tumbling movements in a longer washing cycle. It is recommended for your cotton or linen items (such as bed sheets, pillowcases, jeans, towels, bathrobes, garments, T-shirts, sweat-shirts, etc.). You can select wash temperature according to the soiling level and/or care label of items. Sanitary should be chosen for items that need extra hygiene such as baby clothes, kitchen towels and garments.

#### •Sanitary

You can wash your durable white and colorfast items with this cycle. Washes with vigorous tumbling movements in a longer washing cycle. It is recommended for your cotton or linen items that need extra hygiene such as baby clothes, kitchen towels and garments.

#### • Permanent Press

You can wash your easy care items on this cycle. Washes with gentler tumbling movements and in shorter washing cycles. It is recommended for your cotton, synthetic or blended items (such as shirts, pants, wrinkle-free items, etc.). You can select wash temperature according to the soiling level and/or care label of items.

#### •Delicates

You can wash your delicate easy-care and wrinkle-free items on this program. It has more sensitive tumbling movements and does not do intermediate spinning compared to the permanent program. It must be used for cotton, synthetic or blended clothes for which sensitive washing is recommended.

#### •Wools

You can wash your machine-washable wool items on this program. It is recommended to use appropriate detergents and laundry additives for wools.

### Additional programs

For special cases, there are also extra programs available:

ⓘ Additional programs may differ according to the model of your washer.

#### • BabyProtect

Increased hygiene is provided by a longer heating period and an additional rinse cycle. It is recommended for baby clothes and clothes worn by allergic people.

#### • Hand wash

You can wash your woolen/delicate clothes that bear “hand wash only” labels for which hand wash is recommended on this program. It washes the laundry with very tender washing movements without damaging your clothes.

## Selecting a Program and Operating Your Washer

### • Quick Wash

This program is used to wash a few very lightly soiled and unstained cotton, synthetics or blended items in a short time. e.g.: daily clothes that have been used only once.

### • Sports

This program is used to wash half capacity of normally or lightly soiled daily cotton, synthetics or blended clothes. e.g.: daily clothes and sportswear that have been used only once.

### • Jeans

This programme is used to wash half capacity of normally or lightly soiled jeans and denim jackets. Turn your jeans or jackets inside out before washing. You shouldn't wash more than four pair at a time, this may cause an unbalanced load in the washer.

## Special programs

For specific applications, select any of the following programs:

### • Rinse

This cycle is used when you want to rinse separately.

### • Drain & Spin

This program is used to discharge the water and spin dry the load with selected spin speed. Spin&Drain may be selected as one program in this model.



## CAUTION

⚠ You should select a lower spin speed for delicate wash items.

## Temperature selection

Whenever a new program is selected, the temperature anticipated for that program appears on the temperature indicator.

To change the temperature, press the temperature button. There are four temperature options being cold, warm, hot and extra hot. Temperature selectability depends on the type of wash cycle.

When the "Temperature" button is pressed after Cold is selected, the maximum temperature of the program you have selected will be displayed.

To decrease the temperature, press the "Temperature" button again.

## Spin Speed selection

Whenever a new program is selected, the maximum spin speed of the selected program is displayed on the spin speed indicator.

To decrease the spin speed, press the "Spin" button. Spin speed decreases gradually. Then, rinse hold and no spin options are shown respectively.

You can use no spin function in order to drain the water without spinning at the end of the program.

## Selecting a Program and Operating Your Washer

### Program Cycle Selection Table

	Wash Cycle	Load Type	Soil Level	Water Intake (1)	Wash water Temp.	Max Spin Speed (rpm) (2)	Load Capacity (max) (3)	Bleach (4)	Options Available
Regular/ Cotton	Extra Hot	White and colorfast items made of cotton and linen (towels, jeans, T-shirts, sweatshirts, work clothes)	Heavy	Hot	145F / 63°C	1200	Full	•	SW,S,R,A
	Hot		Normal/ Heavy	Hot	122F / 50°C				
	Warm		Light	Hot-cold	91F/ 33°C				
	Cold		Light	Cold	60F / 15°C				
Sanitary	Extra Hot	White and colorfast items made of cotton and linen (baby clothes, garments, sheets, pillowcases, kitchen towels, tablecloths)	Heavy	Hot	158F / 70°C	1200	Full	•	SW,S,R,A
BabyProtect	Extra Hot	Baby clothes and clothes worn by allergic people	Normal/ Heavy	Hot	158F / 70°C	1200	Full	•	SW,S,R
	Hot			Hot	126F / 52°C				
	Warm			Hot-cold	95F/ 35°C				
Permanent Press	Hot	Easy-care items made of cotton, linen, synthetics or blends (dress shirts/pants, wrinkle-free items, poly/cotton blends)	Normal/ Heavy	Hot	126F / 52°C	1000	1/2	•	SW,S,R,A
	Warm		Light	Hot-cold	95F/ 35°C				
	Cold		Light	Cold	60F / 15°C				
Sports	Warm	Normally or lightly soiled daily cotton, synthetics or blended clothes. e.g.: sportswear	Normal	Cold	95F/ 35°C	1000	1/2	x	SW,S,R
	Cold		Light	Cold	60F / 15°C				
Jeans	Hot	Jeans and denim jackets	Normal/ Heavy	Hot-Cold	126F / 52°C	1000	1/2	x	SW,S,R,A
	Warm		Normal	Hot-Cold	95F/ 35°C				
	Cold		Light	Cold	60F / 15°C				
Quick Wash	Warm	Very lightly soiled cotton, synthetics or blended items	Very Light	Cold	86F/ 30°C	1000	1/4	x	R
	Cold				60F / 15°C				
Delicates	Warm	Delicate easy-care and wrinkle-free items made of cotton, linen, synthetics or blends (dress shirts, blouses, curtains, sheer or lacy garments)	Light	Hot-cold	95F/ 35°C	1000	1/3	x	SW,S,R,A
	Cold		Light	Cold	60F / 15°C				
Hand Wash	Warm	Hand washable items made of synthetics, wool and silk (bras, special care garments, lingerie)	Light	Cold	86F/ 30°C	1000	1/4	x	SW,R
	Cold		Light	Cold	60F / 15°C				
Wools	Warm	Machine washable wool items	Light	Cold	95F/ 35°C	1000	1/4	x	SW,R
	Cold		Light	Cold	60F / 15°C				
Rinse		Any	-	Cold	60F / 15°C	1200	Full	x	-
Drain & Spin		Any	-	-	-	-	Full	-	-

• : Selectable

\* : Automatically selected, not cancellable.

- : See program description for maximum load.

Selectable options of a wash cycle are extra rinse "R", super wash "SW", soak "S" and anti crease "A".

## Selecting a Program and Operating Your Washer

1. Even if there is no hot water system, hot water inlet must still be connected to another cold water faucet. Otherwise a fault will occur on water intake.

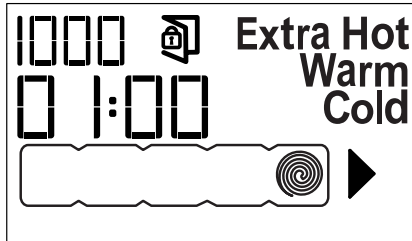

2. Programs are limited with the maximum spin speed appropriate for that particular type of load.
3. Maximum load capacities are suggested for various load types. Wash cycles of full load (Regular/Cotton, permanent press) should be half loaded for better wash results if the laundry is heavily soiled. Half loading would also minimize wrinkling of the load.
4. Bleach may only be used in Regular/Cotton and Permanent Press cycles. Don't use bleach with delicates, handwashables, wools, jeans and sports, this will lead to clothes damage.

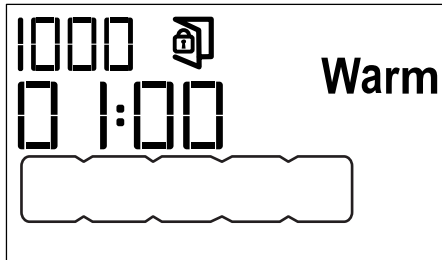

### CAUTION



- The auxiliary functions in the table vary according to the model of your washer.
- Water and power consumption and program duration differ from the table subject to changes in water pressure, water hardness and temperature, ambient temperature, type and amount of laundry, selection of auxiliary functions, and changes in supply voltage.
- Program duration will be displayed on the screen of your washer according to your selection.

## Selecting a Program and Operating Your Washer

### Auxiliary functions

#### Auxiliary Function Selection Buttons

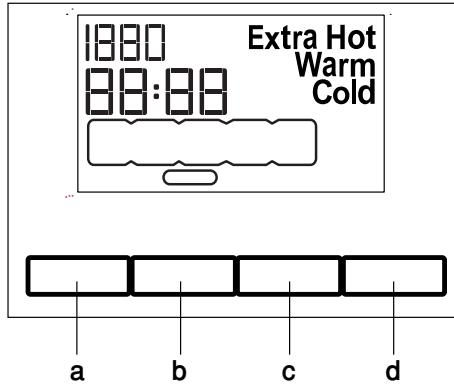

- Depending on the program, you can select the desired auxiliary function by pressing the buttons a, b, c, d.
- Select the required auxiliary functions before starting the program.
- Symbol of the selected auxiliary function will light up.

#### Auxiliary function selection

Auxiliary function that is not compatible with the program cannot be selected. (see, "Program Cycle Selection Table")

##### • Super Wash

This function (a) increases washing times for heavily soiled items for better wash results. Washer will only take in cold water when this function is chosen. This function also increases the amount of rinse water for "Regular/Cotton" cycle.

##### • Soak

This function (b) is used for heavily soiled items when you want to pre-treat them before washing. Laundry is soaked in a relatively high amount of warm water for an hour and a half approximately. You can use full load and HE "High efficiency" detergent for soaking. Use 1/3-1/2 of the recommended detergent dosage for the load amount to be soaked.

##### • Extra Rinse

When this function (c) is selected, you can increase the number of current rinsing steps. Thus, sensitive skins' risk of being affected by the remaining detergent on the clothes will be decreased.

##### • Anti-Crease

With this function (d), drum movement will be lessened to prevent creasing and spinning speed is limited. In addition, washing is carried out at a higher water level.

- Use this function for delicate laundries that crease easily.



#### CAUTION

- Whenever you select this auxiliary function, load your washer with half of the maximum laundry specified in the program table.

## Selecting a Program and Operating Your Washer

### Time display

The display shows the time remaining for the program to complete while a program is running. Time is displayed in hours and minutes as "01:30".

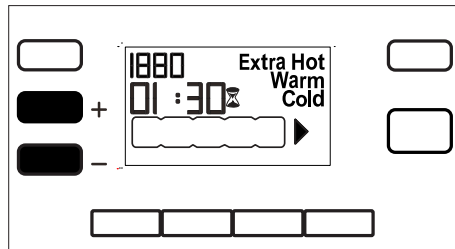

### Time delay

With the "Time delay" function you can delay the program start up to 24 hours. Setting can be made in intervals of 30 minutes.

1. Open the loading door, place the laundry inside and fill detergent drawer.
  2. Set the washing program, temperature, spin speed and, if required, select the auxiliary functions.
  3. Press "Time delaying" buttons "+" and "-" to set your desired time delay. The Time delaying symbol will flash.
  4. Press "Start/Pause/Cancel" button. Then the time delay starts to count down. The Time delaying symbol will light up. The Start symbol will light up. The ":" in the middle of the displayed time delay will start to flash.
- More laundry may be loaded or taken out during the time delay period. At the end of the time delay countdown process, time delaying symbol fades and the washing starts as the program duration is displayed.

### Changing the delay time

If you want to change the time during the countdown:

1. Press "Start/Pause/Cancel" button. ":" in the middle of the screen will stop flashing. The Standby symbol will light up. The Time delaying symbol will flash. The Start Symbol will fade.
2. Press "Time delaying" buttons "+" or "-" to set your desired time delay.
3. Press "Start/Pause/Cancel" button. The Time delaying symbol will light up. The Standby symbol will fade. The Start symbol will light up.
4. The ":" in the middle of the displayed time delay will start to flash.

### Canceling the time delay

If you want to cancel the time delay countdown and start the program immediately:

1. Press "Start/Pause/Cancel" button The ":" in the middle of the displayed time delay will stop flashing.
2. Start symbol will fade. The standby symbol and the time delaying symbol will flash.
3. Press time delaying button "-" to decrease the desired time delay. Program duration after 30 minutes shall be displayed.
4. Press Start/Pause/Cancel Button to start the program.

## Selecting a Program and Operating Your Washer

### Starting the Program

1. Press Start/Pause/Cancel button to start the program.
2. The start symbol which indicates that the program has started will light up.
3. The door locks and the door locked symbol will light up.
4. The Symbol of the relevant step (prewash, main wash, rinse, softener and spin) that the program has started from will light up.

### Progress of program

The progress of a running cycle is shown through a number of symbols on the screen.

- At the beginning of each program step, the relevant symbol in the series of symbols will light up and thus, at the end of the program, all symbols will remain lit up. The symbol that lights up at the far right of the series of symbols indicates the step that is being carried out.

#### Soak

When "Soak" auxiliary function is selected, soak symbol will light up to indicate the beginning of this wash step.

#### Main wash

Main wash symbol will light up to indicate that the main wash cycle has started.

#### Rinse

Rinse symbol lights up at the beginning of the rinse step.

#### Softener

Softener symbol lights up at the beginning of softener step.

#### Spin

Spin symbol will light up at the beginning of the final spin, during "Drain&Spin" special programs.

- If the washer is not spinning, the program may be in rinse hold mode or the automatic spin correction system has been activated due to an excessive unbalanced distribution of laundry in the washer.

### Changing the selections after the program has started

The selected spin speed and program temperature fade out. An empty frame appears.

When the "Program selection" button is brought to the appropriate position, rpm and temperature data reappear.

### Switching the washer to standby mode

The washer is switched to standby mode by pressing "Start/Pause/Cancel" button momentarily. The Standby symbol which indicates the washer is in standby mode lights up and the start symbol that shows the program has started and is still continuing fades out.

#### Selecting or canceling an auxiliary function in pause mode

Auxiliary functions can be cancelled or selected in accordance with the step the program is at.

#### Adding/removing laundry in pause mode

The door can be opened if the water level is suitable. The door locked symbol will light up until the door is suitable for opening. This symbol will fade out as soon as the door is allowed to open. Laundry may be added / taken out by opening the door.



## Selecting a Program and Operating Your Washer

### Door lock

The Door Locked Symbol lights up when the loading door is locked. This symbol will flash until the door is allowed to open. Do not force the door at this stage. This symbol will fade out as soon as the door is allowed to open. You may open the door after the symbol fades out.

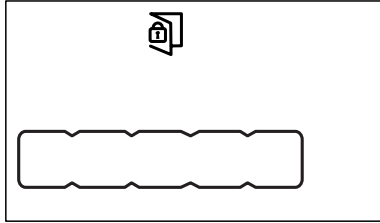

When the electricity is off in door locked position, door will keep the locked position for two minutes. After two minutes, door is allowed to open.

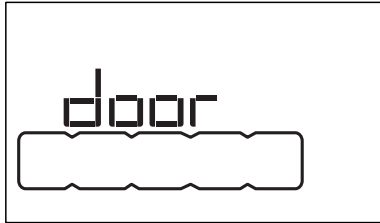

In case the door is not locked, "door" expression will appear on the screen. In that case, door should be opened and closed again firmly.

### Child-proof lock

Protect the appliance from being tampered by children by means of the child-proof lock. In this case, no change can be made in the running program.

#### CAUTION



- Your washer can be turned on and off with On/Off button while the child-proof lock is activated. In this case, your washer will resume its program with child-proof lock activated.

The washer is switched to child-lock by pressing the 2nd and 4th auxiliary functions for 3 sec. "C:on" (Child-proof lock is activated) label appears on the display.

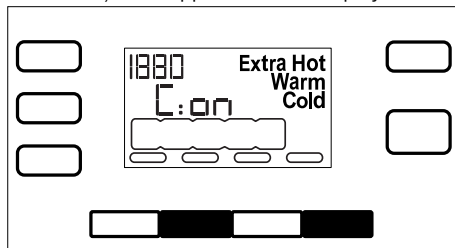

The same symbol will also be displayed whenever any button is pressed while the washer is child-locked.

## Selecting a Program and Operating Your Washer

To deactivate the child-proof lock, press the 2nd and 4th auxiliary function buttons for 3 sec.  
“C:OFF” (Child-proof lock is deactivated) label appears on the screen.

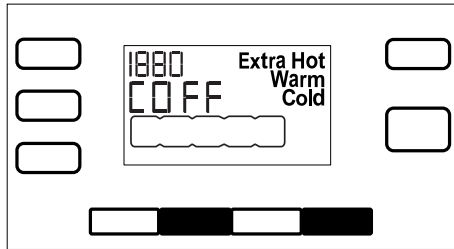

### Ending the program through canceling

“Start/Pause/Cancel” button is pressed for 3 seconds to cancel the program. Start symbol will flash during cancellation. After cancellation, the symbol of the corresponding step at which the cancellation was made will remain lit and “End” will appear on the screen.

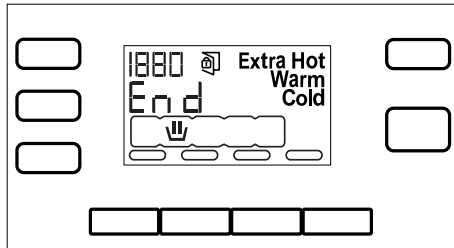

### End of program

When the program is finished, the symbols of the relevant steps will remain lit up and the auxiliary function, spin and temperature data selected at the start-up of the program will remain selected. “End” will appear on the display.

## 6 Preparation

1. Turn on both hot and cold water faucets fully. Check and be sure the water connection is tight.
2. Place the laundry in the drum.
3. Add laundry additives (e.g. detergent, fabric softener, bleach).

### Starting

1. Press the “On/Off” button.
2. Select the appropriate wash cycle and temperature suitable for your items.
3. If required:
  - select any auxiliary function,
  - adjust the spin speed,
  - set the time delay,
4. Close the loading door.
5. Press “Start/Pause/Cancel” button.

The display shows the time remaining for the program to complete if time delay is not set.

The display shows the time remaining for the program to start if the time delay is set.

6. Check if the Door Locked Symbol lights up on the screen.

The Door Locked Symbol will light up if time delay is not set.

The Door Locked Symbol will fade if time delay is set.

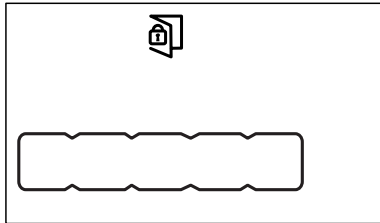

### Canceling a program

1. Press and hold the ‘Start/Pause/Cancel’ button for about 3 seconds; the “Start” symbol will start flashing.
2. The washer can drain all the water or can take in water for 3 times at most to cool down the clothes and complete draining process.

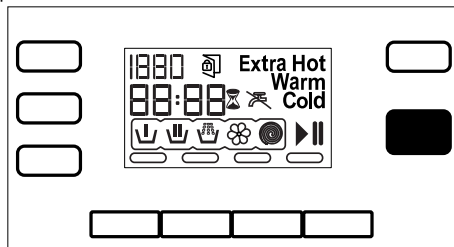

## Preparation

### Adding more laundry

This is only possible under the following conditions:

1. during time delay,



#### CAUTION

ò You may add or remove laundry during the time delay (until the program starts).

2. At the beginning of a washing cycle,



#### CAUTION

ò Washer allows adding more laundry during a future step only if the water level is low enough to open the loading door or if the temperature in the washer is low

In order to add laundry after the start-up of the program:

1. Press "Start/Pause/Cancel" button. Wait for the safety lock to open .
2. Open the loading door and put in more laundry.
3. Close the loading door.
4. Press "Start/Pause/Cancel" button.

**If you want to discharge the water without spinning:**

1. Press "Start/Pause/Cancel" button.
2. The standby symbol fades out and the start symbol lights up.
3. The program continues and only pumps out the water.

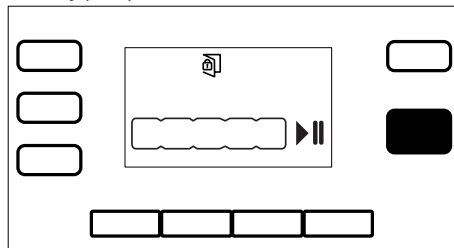

## Preparation

### Re-spinning the laundry

The control system for an unbalanced load can pause the spinning in cases when the distribution of the laundry in the drum is not balanced.

If you want to re-spin the clothes:

1. Rearrange the previously placed clothes in the drum.
2. Select the spin program.
3. Adjust the spin speed.

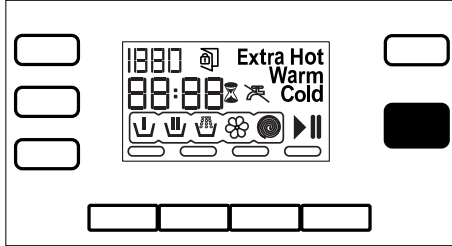

### After the program is finished

Program indicator symbols on the screen will light up after the program is finished. "End" will appear on the screen.

1. Open the loading door and remove the laundry when the door locked symbol on the display fades out.
2. Press the "On/Off" button .
3. Turn off the faucets.
4. Check the rubber door seal for any foreign objects.
5. Leave the door and dispenser drawer open to dry.

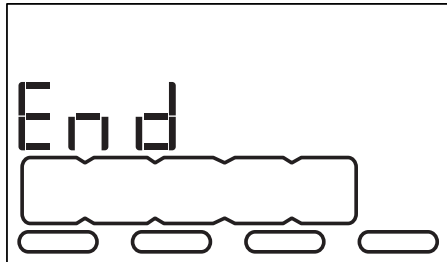

## 7 User maintenance instructions



### WARNING

- ⓘ Be sure to unplug the power cable before attempting maintenance or cleaning of your appliance to minimize the risk of electric shock.

### Cleaning detergent dispenser

Remove any powder/liquid residue buildup in the dispenser drawer. To do this;

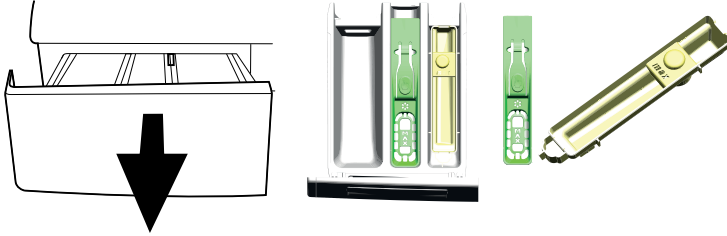

1. Press the dotted point on the siphon of the softener compartment and pull towards yourself until it is removed from the dispenser.



### CAUTION

- ⓘ If more than a normal amount of water and softener/bleach mixture starts to gather in the dispenser compartments, dispenser must be cleaned.

2. Wash the dispenser drawer, liquid chlorine bleach container and siphon of softener under running warm water in a sink etc. Wear protective gloves or use an appropriate brush or sponge to avoid touching the detergent residues in the drawer when cleaning.
3. Replace the drawer into its housing after cleaning. Check if the siphon and container are in their original locations.

### Cleaning the door seal

Be sure to check the rubber door seal after unloading your washer. Pull the seal back to search for any foreign objects. Residual metal objects such as pins and coins may form rust stains on rubber seal, and cause the seal to leak.

Wipe the stained areas with soapy water using a damp cloth. Then wipe with a dry cloth properly. Do not use an abrasive scrubbing agent when cleaning rubber seal.

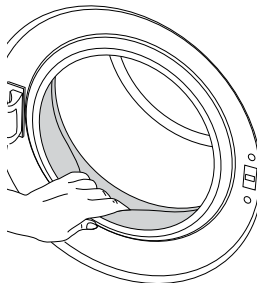

### Cleaning the drum

Check the wash drum for any foreign objects after unloading your washer. Residual metal objects such as pins and coins may form rust stains on drum surface and your clothes. Do not use abrasive

## User maintenance instructions

materials while cleaning the inner surface of the drum. Use soapy water with a damp cloth to wipe the inner surface, then dry it and leave the door open to let inside dry properly.

Sanitary cycle with extra rinse option should be used for monthly cleaning of drum. To carry out this procedure:

First be sure that the drum is empty.

Add 80ml of liquid chlorine bleach to the bleach container in the right compartment of the dispenser. Select sanitary cycle, close the door and press "start/pause" button. At the completion of cycle, leave the door open for drying of drum interior.

Monthly cleaning of the washer is necessary for removal of bacteria and mold residues and prevention of unwanted odor in wash drum.

### Cleaning the outer cabinet and control panel

When necessary:

- Wipe the exterior panels of your washer with soapy water or mild detergent. Dry it with a soft cloth.
- Use only a soft and damp cloth to clean the control panel.



#### CAUTION

- Never use a sponge or scrubbing material. These will damage the painted and plastic parts.

### Cleaning the water inlet strainers

There is a strainer at the end of each water inlet valve at the back side of the washer and also at the end of each water inlet hose where they are connected to the faucets. These strainers prevent the foreign substances and dirt in the water to enter into the washer. Strainers should be cleaned from time to time.

- Close the water faucets.
- Remove the nuts of the water inlet hoses to clean the surfaces of the strainers on the water inlet valves with an appropriate brush.

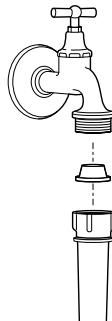

- If the strainers are very dirty, you can pull them out by means of pliers and clean them.
- Take out the strainers on the flat ends of the water inlet hoses together with the rubber seals and clean thoroughly under running water.
- Replace the rubber seals and strainers carefully and tighten the hose nuts by hand.

## User maintenance instructions

### Cleaning the drain pump filter

Filter system in your washer prevents solid items such as buttons, coins and fabric fibers clogging the pump impeller during discharging of the washing water. Thus, a good water discharge is achieved and the pump life is extended.

- If your washer fails to drain the water, the pump filter may be clogged. You may have to clean it occasionally to prevent any clogging. Water must be drained completely to clean the pump filter.

In addition, water may have to be drained off completely in the following cases:

- before transporting the appliance (e.g. when moving)
- when there is a danger of frost

In order to clean the dirty filter and discharge the water;

1- Disconnect or unplug the washer from the power supply.

### WARNING



- ⓘ There may be water at 158F (70°C) in the drum. Therefore, the filter must be cleaned only after the inside water is cooled down to avoid hazard of scalding.

2- Open the filter cap. The filter cap may be composed of one or two pieces according to the model of your washer.

If it is composed of two pieces, press the tab on the filter cap downwards and pull the piece out towards yourself.

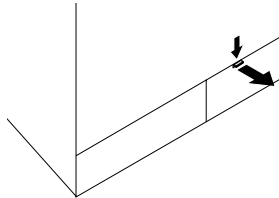

If it is composed of one piece, hold it from both sides and open it by pulling out.

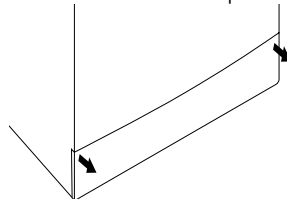

3- An emergency drain hose is supplied with your washer.



## User maintenance instructions

Do the following as shown in the figure below:

- Pull out the emergency drain hose from its housing.

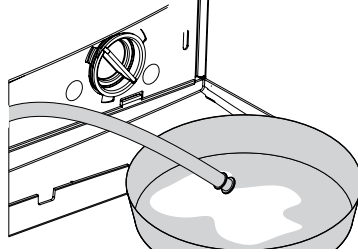

- Place a large container at the end of the hose. Drain the water off into the container by pulling out the plug at the end of the hose. If the amount of water to be drained off is greater than the volume of the container, replace the plug, pour the water out, then resume the draining process.
- After draining process is completed, replace the plug into the end of the hose and fit the hose back into its place.
- When there is no water left, turn the pump filter until it is completely loose and remove it.
- Clean any residues inside the filter as well as fibers, if any, around the impeller region.
- Never force the filter while replacing it into its housing. Fit the filter fully into its housing; otherwise, water may leak from the filter cap.

#### 4- Close the filter cap.

Close the two-piece filter cap of your product by pushing the tab on it.

Close the one-piece filter cap of your product by fitting the tabs on the bottom into their positions and pushing the upper part of it.

## Descaling the washer

Hard water can cause scale build-up inside the drum and other parts of your washer in time. Scaling may lead to some serious problems such as clogging in hoses, heater or pump failure eventually. To prevent scaling, wash drum should be cleaned frequently. Do not use abrasive materials such as metal wool while cleaning the drum.

Take the manufacturer's instructions into account if you are using a descaling agent. Descaling agents may contain materials that are hazardous for washer components. Use descaling agents compatible for use in clothes washers.

When using a powder descaling agent, add 1 cup to the main wash compartment of the dispenser and run a regular hot cycle (with extra rinse) without any clothes and detergents.

## 8 Troubleshooting

Problem	Cause	Explanation / Suggestion
Water in the washer.	There may be some water in your appliance when you receive it. This is from the quality control process and is normal.	It is not harmful to your washer. You should run a "sanitary" cycle without any clothes and laundry additives before the first use of your washer.
Washer does not fill with water or wash after the program was selected and the "Start/Pause/Cancel" button was pressed.	Faucets may be turned off.	Open the water faucets fully.
	Water inlet hose may be folded.	Check the water inlet hose and straighten if necessary.
	Water inlet strainers might be clogged.	Clean the water inlet strainers.
	Is there power at the outlet?	Call an electrician and have the power outlet / circuit breaker / fuse checked.
	Washer might be unplugged.	Plug the power cord to a live electrical outlet.
	Drain hose may be folded.	Check the drain hose and straighten if necessary.
	Washer may be in handwash, wools or soak cycle.	Wait for a short time and tumbling will start.
	Drain pump filter or drain itself may be clogged.	Clean the drain pump filter (See "User maintenance instructions"). If the house drain pipes are clogged, call a plumber for assistance.
Washer does not drain water / Washer drains water slowly.	Door may not be closed properly.	Close the loading door.
	Drain hose may be folded.	Check the drain hose and straighten if necessary.
The water being taken in is directly discharged.	Drain pump filter or drain itself may be clogged.	Clean the drain pump filter (See "User maintenance instructions"). If the house drain pipes are clogged, call a plumber for assistance.
	Improper position of the drain hose.	Connect the drain hose as described in the user manual (See "Installation Instructions, Drainage").
No water can be seen in the drum during washing.	This is not a problem. The water level is not visible from the outside of the washer.	
Washer stopped shortly after the program cycle started.	Washer can stop temporarily due to low voltage.	It will resume operating when the voltage is back to the normal level.

## Troubleshooting

There is water coming from the bottom of the washer.	Inlet hose connections may be leaking.	Be sure the strainers and rubber seals of the water inlet hoses are solid and securely fitted.
	End of the drain hose may be loosely inserted into the waste pipe or sink.	Tightly attach the drain hose to the waste pipe or sink (See "Installation Instructions, Drainage").
	House drain may be clogged.	If the house drain pipes are clogged, call a plumber for assistance.
	Filter cap of the drain pump may not be properly fitted.	Make sure that the pump filter cap is tightly closed.
	Hose connections inside the washer may be leaking.	Internal hose connections (e.g. dispenser hoses, drain system) should be checked by a service technician.
Washer fills with water when a process is cancelled.	There may be hot water inside washer.	For safety reasons, water should be cycled in and out a couple times.
Time delay function does not work.	Door may not be closed properly.	Close the loading door.
The door will not open.	Water level might be above the lower level of the door.	Run "Drain", "Spin" or "Drain&Spin" program.
	Washer might be heating up the water or it may be at the spinning cycle.	Wait until the process is over.
	Due to electrical safety mechanism, the door can only be opened a few minutes after the program has stopped.	Wait until the process is over.
	If the door can not be opened after minimum ten minutes the program has stopped, on/off buton should be placed to off position.	In this situation, call the qualified service technician.
The door will not lock/ door expression is on LCD	Door is not properly closed/Door hinge is not aligned with lock switch.	Push the loading door firmly shut until you hear it lock into space

## Troubleshooting

<p><b>Cycle time takes longer than the time specified in the owner's guide.</b></p>	<p><b>Water pressure may be low.</b></p>	<p>The washer will wait until there is a sufficient amount of water, which may lengthen the cycle time to avoid poor washing results due to insufficient water.</p>
	<p><b>Supply voltage may be low.</b></p>	<p>Cycle time is lengthened to avoid poor washing results when the supply voltage is low.</p>
	<p><b>Inlet temperature of water may be low.</b></p>	<p>Cycle time lengthens to heat up the water when the inlet water is cold. Also, washing time can be lengthened to avoid poor washing results.</p>
	<p><b>There may be an imbalance of load in the drum.</b></p>	<p>The automatic spin correction system might have been activated due to the unbalanced distribution of the laundry in the drum.</p>
	<p><b>Number of rinse cycles might have increased to obtain a better rinse.</b></p>	<p>Use a proper amount of HE detergent. Reduce the amount of detergent next time you operate the washer.</p>
<p><b>It continuously washes. Remaining time does not count down.</b></p>	<p><b>In the case of a paused countdown while taking in water: Timer will not countdown until the washer is filled with the correct amount of water. Time will not count down until the selected temperature for the program is reached</b></p>	<p>The washer will wait until there is a sufficient amount of water to avoid poor washing results due to lack of water. Then the timer will start to count down.</p>
	<p><b>In the case of a paused countdown at the heating step: Time will not count down until the selected temperature for the program cycle is reached.</b></p>	
	<p><b>In the case of a paused countdown at the spinning step: There may be an imbalance of laundry in the drum.</b></p>	<p>The automatic spin correction system might have been activated due to the unbalanced distribution of the laundry in the drum.</p>
		<p>The laundry in the drum may be tangled up too much. Laundry should be rearranged and re-spun.</p>
	<p>No spinning is performed when the laundry is not evenly distributed in the drum to prevent any damage to the appliance and to its environment.</p>	

## Troubleshooting

It continuously spins. Remaining time does not count down.	There may be an imbalance of load in the drum.	The automatic spin correction system might have been activated due to the unbalanced distribution of the laundry in the drum.
		The laundry in the drum may be tangled up too much. Laundry should be rearranged and re-spun.
		No spinning is performed when the laundry is not evenly distributed in the drum to prevent any damage to the appliance and to its environment.
Excess foaming occurs.	Using excessive amount of detergent.	Use the recommended amount of HE detergent appropriate for water hardness, soil level and amount of laundry.
	Not using HE detergent	Use HE detergent.
	Detergent may have been stored improperly.	Store detergent in a cool and dry place.
	Type of material being washed (lace items will cause excessive foam due to their meshed structure).	Reduce the amount of detergent for lace items.
Washer is completely full of suds/Suds coming out of dispenser during operation.	Not using HE detergent / Using excessive amount of detergent	Push "Start/Pause/Cancel" button. Mix 2 cups of water with 1-2 tablespoon of fabric softener and pour it into detergent dispenser. Push "Start/Pause/Cancel" button again. Use proper amount of HE detergent next time you operate the washer.
Load is still too soapy / Washer is full of suds at the end of program.	Not using HE detergent / Using excessive amount of detergent	Do not unload the washer. Operate a quick wash cycle (e.g. Delicates, Wools) without any detergent. Add 1-2 tablespoon of fabric softener into main wash compartment of detergent dispenser during water intake. Use proper amount of HE detergent next time you operate the washer.
Load is still too wet at the end of program.	Unbalance detection due to 1-2 small items in the drum (uneven load distribution)	Add more laundry (e.g. a few additional towels) to the drum and start a "Spin" or "Spin&Drain" cycle.
	Poor spinning results due to not using HE detergent / using excessive amount of detergent	Use proper amount of HE detergent.

## Troubleshooting

Washer did not spin.	There may be an imbalance of load in the drum. Therefore, the program cycle might have been completed without spinning.	The automatic spin correction system might have been activated due to the unbalanced distribution of the laundry in the drum. No spinning is performed when the laundry is not evenly distributed in the drum to prevent any damage to the appliance and to its environment.
		The laundry in the drum may be tangled up too much. Laundry should be rearranged and re-spun.
	Unbalance detection due to 1-2 small items in the drum (uneven load distribution)	Add more laundry (e.g. a few additional towels) to the drum and start a "Spin" or "Spin&Drain" cycle.
	Drain hose may be folded.	Check the drain hose and straighten if necessary.
	"No spin" setting may be adjusted.	See "Spin Speed Selection".
Drain pump filter or drain itself may be clogged.	Clean the drain pump filter (See "User maintenance instructions"). If the house drain pipes are clogged, call a plumber for assistance.	
Washing performance is poor: Laundry turns gray/yellow	Using insufficient amount of detergent.	Use the recommended amount of HE detergent appropriate for water hardness and soil level of laundry.
	Washing at low temperatures for a long time	Select the proper temperature for the laundry to be washed (See "Laundry Tips" & "Program Cycle Selection").
	Using insufficient amount of detergent for hard water (soil can stick to the laundry)	If the water hardness is high, using an insufficient amount of detergent can cause laundry to turn gray over time.
	Using excessive amount of detergent (detergent can stick to the laundry).	It is difficult to eliminate such grayness once it occurs.
	Not using HE detergent	Use HE detergent.
	Dyeing problem occurs.	Sort the wash load by color (See "Laundry Tips").
	Hot water inlet temperature is not high enough.	Set your water heater for delivering 120-140F (48-60 C) hot water.
	A higher temperature might have been selected.	Select the proper program cycle and temperature according to the type and soiling degree of the laundry.

## Troubleshooting

<p><b>Washing performance is poor: Stain could not be removed, not cleaned. Laundry could not be whitened.</b></p>	<p><b>Wrong program cycle and temperature might have been selected.</b></p>	<p>Select the proper program cycle and temperature for the laundry to be washed (See “Laundry Tips” &amp; “Program Cycle Selection”).</p>
	<p><b>Using insufficient amount of detergent.</b></p>	<p>Use the recommended amount of HE detergent appropriate for water hardness and soil level of laundry.</p>
	<p><b>Using wrong type of detergent.</b></p>	<p>Use liquid detergent for cold wash cycle for good wash results. Use proper detergents recommended for wools, handwashable and delicate items.</p>
	<p><b>Mixing different sorts of items.</b></p>	<p>Sort the laundry according to care labels and user manual (See “Laundry Tips”).</p>
	<p><b>Mixing different types of laundry additives.</b></p>	<p>Put the detergent in the correct compartment of dispenser (See “Detergent Dispenser”).</p>
		<p>Do not mix detergent with bleaching agent or fabric softener.</p>
<p><b>Excessive laundry may be loaded into washer.</b></p>	<p>Do not load the washer in excess.</p>	
<p><b>Washing performance is poor: Oily stains appear on laundry.</b></p>	<p><b>Oily accumulations of prior wash cycles on the drum may have stuck to the laundry.</b></p>	<p>Washer must be operated empty at sanitary cycle with detergent.</p>
	<p><b>The detergent may have been placed into the wrong compartment; the detergent may be mixed with the softener.</b></p>	<p>Softener should not come into contact with detergent when being added.</p>
<p><b>Bad odor in the drum and detergent dispenser.</b></p>		<p>Such odor and bacteria layer may be formed on the drum as a result of continuous washing at lower temperatures and/or in short programs. Leave the dispenser drawer as well as the loading door ajar after each washing. Thus, a humid environment favorable for bacteria cannot be created inside the machine.</p>
		<p>For monthly cleaning procedure of the drum, See “Cleaning the Drum”.</p>
		<p>Wash and clean the dispenser with warm water frequently (See “Cleaning Detergent Dispenser”).</p>

## Troubleshooting

Clothes are stiff and/or do not smell like the fabric softener.	Using insufficient amount of detergent.	If the water hardness is higher, using insufficient amount of detergent can cause the laundry to become stiff in time. Use appropriate amount of detergent according to the water hardness.
	Softener being released early.	You may have added too much softener beyond max fill line.
		The detergent dispenser might be problematic. Water may be siphoned (pulling the softener into the washer early) during the fill or rinse cycles.
	There might be problems with the water inlet valves.	
The detergent may have been placed into the wrong compartment; the detergent may be mixed with the softener.	Softener should not come into contact with detergent / bleach when being added.	
Color of the clothes faded.	A higher temperature might have been selected.	Select the proper program and temperature according to the type and soiling degree of the laundry (See "Laundry Tips" & "Program Cycle Selection").
	Exposure of laundry to undiluted liquid chlorine bleach.	Do not pour undiluted liquid bleach onto laundry. Always pour it into bleach compartment of the dispenser prior to beginning of the wash cycle .
		Do not overfill the bleach compartment. Fill up to max line at the most.
Excessive laundry might have been loaded in.	Do not load the washer in excess.	



## Troubleshooting

Rinsing performance is poor.	Intermediate spins may be skipped.	There may be an imbalance of laundry in the machine. The laundry in the drum may be tangled up too much. Laundry should be rearranged and re-spun. No spinning is performed when the laundry is not evenly distributed in the drum to prevent any damage to the appliance and to its environment.
	The amount and storage conditions of the detergent used might not be appropriate.	Store detergents in a cool and dry place. Do not keep them under high temperatures.
	Not using HE detergent	Use HE detergent.
	Using excessive amount of detergent	Reduce the amount of detergent.
	Drain hose may be folded.	Check the drain hose and straighten if necessary.
	Drain pump filter or drain itself may be clogged.	Clean the drain pump filter (See "User maintenance instructions"). If the house drain pipes are clogged, call a plumber for assistance.
Detergent or softener residue in the dispenser/ Too much water remains in the softener compartment.	Detergent (powder) may have been put in wet dispenser drawer.	Dry the dispenser drawer before putting in powder detergent.
	Detergent (powder) may have gotten damp.	Store detergent in a cool and dry place. Do not keep them under high temperatures.
	Softener may be too dense or concentrated.	Dilute the softener by pouring some warm water on it (dilute up to max fill line).
	Water pressure might be low.	
	Detergent might be mixed with the bleach/softener.	Softener/bleach should not come into contact with detergent when being added.

## Troubleshooting

Washer vibrates, shakes or makes too much noise.	Feet might require adjustment.	Adjust the washer feet (See “Levelling the Washer”).
	Shipping bolts might not have been removed.	Remove the shipping bolts (See “Removing Transport/Shipping Bolts”).
	There may be a small amount of laundry in the drum.	Add more laundry to the drum for even load distribution next time you operate the washer.
	The drum may be overloaded or the clothes may be distributed unevenly.	Reduce the amount of laundry in the drum or balance the load by hand next time you operate the washer.
	The appliance might be touching a solid surface.	Ensure that nothing touches the washer.
Strange noise in the drain pump.	This is not a problem. Lapping sound is normal at the end of the drain operation.	It is not harmful to your washer.
Clanking noise in the drum.	Metal objects such as coins, pins may be in the drum.	Stop the program cycle (See “Cancelling a Program”) ,check the drum for any foreign objects.
Water fill temperature is incorrect.	Water inlet hoses or valves may be clogged.	Disconnect inlet hoses from the valves. Clean inlet strainers and valve filters of any debris.
	There may be a long distance between the water heater and washer.	Run the hot water faucets in the bathroom or kitchen (whichever is close to the location of your washer) for a short time to purge the hot water line.
	There may be a problem with water heater.	Be sure that your water heater is delivering hot water min 120F (49C) at the faucet.

## Troubleshooting

Detergent residue left on the laundry.	Excessive laundry might have been loaded in.	Do not load the washer in excess.
	Wrong program cycle and temperature might have been selected.	Select the proper program cycle and temperature for the laundry to be washed (See “Laundry Tips” & “Program Cycle Selection”).
	Using insufficient amount of detergent.	Use the recommended amount of HE detergent appropriate for water hardness and soil level of laundry.
	Using powder or granular detergents in cold water washing may leave residue on wash load.	Try to use a liquid detergent when washing in cold water.
	Using wrong type of detergent.	Use liquid detergent for cold wash cycle for good wash results. Use proper detergents recommended for wools, handwashable and delicate items.
Clothes get tangled up too much in the drum when washing.	Excessive laundry might have been loaded in.	Do not load the washer in excess.
	Washing many items of the same type or size of clothes together.	Load the wash drum with items of different sizes.
Load is wrinkled.	Delay in unloading the washer.	Unload the washer as soon as the wash cycle ends.
	Wrong program cycle might have been selected.	Select the proper program cycle for the laundry to be washed (See “Laundry Tips” & “Program Cycle Selection”).
	Excessive laundry might have been loaded in.	Do not load the washer in excess.
Washer does work. Nothing is displayed on the screen.	The plug might not be plugged in the mains outlet.	Check the plug.
	Fuse may have blown.	Check the fuse / circuit breaker.
	Power may be cut off.	Check the supply power.
	The “On/Off” button might not have been pressed.	Press this button.
Water Cut off symbol on LCD is light up	Water may have been cut off.	You can restart your machine by pressing the “Start/Pause/Cancel” button for a short time after ensuring that the water is not cut off.

## 9 WARRANTY STATEMENT FOR THE BLOMBERG CLOTHES WASHERS

The warranties provided by Blomberg in these statements only apply to Blomberg washers sold to the original purchaser or homeowner in the US and Canada. The warranty is not transferable. To obtain warranty service, please contact our nearest distributor as listed by state. You will need your washer model number, serial number, retailer name and address, where purchased and purchase date / installation date. This warranty gives you specific legal rights, and you may also have other rights which vary from state to state.

1 year \* limited warranty from date of first installation Blomberg will repair or replace at no cost to the consumer any defective parts of the washer if used under normal household conditions (warranty is void if the product is used commercially e.g., bed + breakfast, nursing home etc.). Service must also be performed by an authorized Blomberg service agency. (Cosmetic defects must be reported within 10 business days from installation)

2 year \* ++ limited warranty from date of first installation (Parts only) Blomberg will repair or replace any parts at no cost to the consumer if material defects or workmanship have caused the damage or failure of these components. Again the appliance must have been used under normal household conditions and not commercially as stated above (Labor charges are the responsibility of the consumer)

5 year \* ++ limited warranty from date of first installation (parts only 2-5 years) Blomberg will repair or replace any circuit boards or washer drum (excluding any plastic attachments) at no cost to the consumer if material defects or workmanship have caused the damage or failure of these components. The washer must have been used under normal household conditions and not commercially (Labor charges are the responsibility of the consumer)

Lifetime limited warranty from date of first installation \* ++ (parts only) Blomberg will repair or replace to the original owner the stainless steel drum if rust through occurs under normal household use and normal water conditions (no excessive chlorine). Blomberg may, at its option, also replace the whole washer with the same and/or equivalent model with equal or better functionality if the original model is no longer available. (Labor, removal and installation charges are the responsibility of the consumer.)

### Disclaimers of warranties and exclusions:

Warranty does not cover service costs by an authorized service agent to correct installation, electrical and plumbing problems or educational instruction on the use of the washer. The warranty also does not cover defects or damage caused by an act of god (such as storms, floods, fires, mudslides, etc.), damage cause by use of the washer for purposes other than those for which it was designed, misuse, abuse, accident, alteration, improper installation, maintenance, travel fees, service calls outside normal service hours, unauthorized service work or work.

This product is fully tested and went through official quality assurance inspections before leaving the original manufacturing site. Warranty terms for this Blomberg household appliance is not valid if the product is altered, tampered, modified, additional parts assembled, fixed and re-packed by an authorized distributor, servicer, a third party retailer, reseller or by any other unauthorized person(s)''

TO THE EXTENT PERMITTED BY LAW, THIS WARRANTY IS IN LIEU OF ALL OTHER EXPRESSED AND IMPLIED WARRANTIES, INCLUDING THE IMPLIED WARRANTIES OF MERCHANTABILITY AND FITNESS FOR A PARTICULAR PURPOSE. BLOMBERG UNDERTAKES NO RESPONSIBILITY FOR THE QUALITY OF THIS PRODUCT EXCEPT AS OTHERWISE PROVIDED IN THIS WARRANTY STATEMENT. BLOMBERG ASSUMES NO RESPONSIBILITY THAT THE PRODUCT WILL BE FIT FOR ANY PARTICULAR PURPOSE FOR WHICH YOU MAY BE BUYING THIS PRODUCT, EXCEPT AS OTHERWISE PROVIDED IN THIS WARRANTY STATEMENT.

Blomberg does not assume any responsibility for incidental or consequential damages. Such damages include, but are not limited to, loss of profits, loss of savings or revenue, loss of use of the washer or any associated equipment, cost of capital, cost of any substitute equipment, facilities or services, downtime, the claims of third parties, and injury to property. Some states do not allow the exclusion or limitation of incidental or consequential damages, so the above limitations or exclusion may not apply to you. \* installation date shall refer to either purchase date or 5 business days after delivery of the product to the home, whichever is later.

++Parts replaced will assume the identity of the original parts + their original warranty.

No Other Warranties. This Warranty Statement is the complete and exclusive warranty from the manufacturer. No employee of Blomberg or any other party is authorized to make any warranty in addition to those made in this Warranty Statement.

However, Arcelik should also make sure that its warranty which is given to consumers makes it clear that the warranty does not cover any modifications or additions to the product made by the distributor or anyone else. It covers only the product as delivered by Arcelik to the distributor, and any modification or addition by the distributor or anyone else voids the warranty.

## **10 HOW TO GET SERVICE**

Please contact the Distributor for your State or Province as listed on the Distributor Contact List, or call our Toll Free Number at 1 800 459 9848 for direction to an Authorized Blomberg Service Agent.





