

BLUESTAR 36" INDUCTION COOKTOP INSTRUCTION AND INSTALLATION MANUAL

VERSION 1 – 12132015

WELCOME !

THANK YOU FOR CHOOSING OUR INDUCTION COOKTOP.

IN ORDER TO MAKE THE BEST USE OF YOUR APPLIANCE, WE WOULD ADVISE YOU TO CAREFULLY READ THE FOLLOWING NOTES AND TO KEEP THEM FOR LATER USE.

WE ACHIEVE CUSTOMER SATISFACTION BY ENSURING THAT EACH OF OUR EMPLOYEES UNDERSTANDS, MEETS AND EXCEEDS CUSTOMER EXPECTATIONS. WE ESTABLISH AND MAINTAIN AN ENVIRONMENT THAT ENCOURAGES ALL EMPLOYEES TO PURSUE CONTINUOUS IMPROVEMENT IN QUALITY AND PRODUCTIVITY.

OUR QUALITY POLICY IS MONITORED BY THE HIGHEST LEVELS OF MANAGEMENT.

WE HOPE YOU ENJOY YOUR NEW APPLIANCE AND WE THANK YOU AGAIN FOR BELIEVING IN OUR PRODUCT AS MUCH AS WE DO.

THE STAFF AND TEAM AT BLUESTAR !

1. SUMMARY

Contents

1. SUMMARY.....	3
2. SAFETY INSTRUCTIONS.....	4
3. DESCRIPTION.....	8
4. USE OF THE APPLIANCE.....	9
5. MAINTENANCE AND CLEANING.....	17
6. TROUBLESHOOTING GUIDE.....	19
7. INSTALLATION INSTRUCTIONS.....	20
ELECTRICAL CONNECTION.....	22
WARRANTY.....	23
PERFORMANCE CHECKLIST.....	24

2. SAFETY INSTRUCTIONS

IMPORTANT INSTRUCTIONS

IMPORTANT NOTE: • *Read this use & care guide carefully before using your new cooktop to reduce the risk of fire, electric shock or injury to persons. Important*

IMPORTANT : Save for the local electrical inspector's use

- Ensure proper installation and servicing. This appliance must be properly installed and grounded by a qualified technician. Have the installer show you the location of the circuit breaker or fuse so that you know where to turn off power.
- Warranty service must be performed by authorized Bluestar servicers.
- Before performing any service, disconnect the power supply to the cooktop by switching off the circuit breaker or removing the fuse.
- Proper Installation – Be sure your appliance is properly installed and grounded by a qualified technician.
- Never Use Your Appliance for Warming or Heating the Room.
- Do Not Leave Children Alone – Children should not be left alone or unattended in area where appliance is in use. They should never be allowed to sit or stand on any part of the appliance.
- Wear Proper clothing – Loose-fitting or hanging garments should never be worn while using the appliance.
- User Servicing – Do not repair or replace any part of the appliance unless specifically recommended in the manual. All other servicing should be referred to a qualified technician.
- Storage in or on Appliance – Flammable materials should not be stored in an oven or near surface units.
- Do Not Use Water on Grease Fires – Smother fire or flame or use dry chemical or foam-type extinguisher.
- Use Only Dry Potholders – Moist or damp potholders on hot surfaces may result in burns from steam. Do not let potholder touch hot heating elements. Do not use a towel or other bulky cloth.
- DO NOT TOUCH SURFACE UNITS OR AREAS NEAR UNITS – Surface units may be hot even though they are dark in color. Areas near surface units may become hot enough to cause burns. During and after use, do not touch, or let clothing or other flammable materials contact surface units or areas near units until they have had sufficient time to cool. Among these areas are (identification of areas – for example, the cook-top and surfaces facing the cook-top).

IMPORTANT INSTRUCTIONS

- CAUTION – Do not store items of interest to children in cabinets above a range or on the backguard of a range – children climbing on the range to reach items could be seriously injured
- To eliminate the risk of burns or fire by reaching over heated surface units, cabinet storage space located above the surface units should be avoided. If cabinet storage is to be provided, the risk can be reduced by installing a range hood that projects horizontally a minimum of 5 inches beyond the bottom of the cabinets.
- Use Proper Pan Size – This appliance is equipped with one or more surface units of different size. Select utensils having flat bottoms large enough to cover the surface
- The use of undersized utensils will expose a portion of the heating element to direct contact and may result in ignition of clothing.
- Relationship of utensil to burner will also improve efficiency.
- Never Leave Surface Units Unattended at High Heat Settings – Boilover causes smoking and greasy spillovers that may ignite.
- Make Sure Reflector Pans or Drip Bowls Are in Place – Absence of these pans or bowls during cooking may subject wiring or components underneath to damage.
- Protective Liners – Do not use aluminum foil to line surface unit drip bowls or oven bottoms, except as suggested in the manual. Improper installation of these liners may result in a risk of electric shock, or fire.
- Glazed Cooking Utensils – Only certain types of glass, glass / ceramic, ceramic, earthenware, or other glazed utensils are suitable for range-top service without breaking due to the sudden change in temperature.
- Utensil Handles Should Be Turned Inward and Not Extend Over Adjacent Surface Units – To reduce the risk of burns, ignition of flammable materials, and spillage due to unintentional contact with the utensil, the handle of a utensil should be positioned so that it is turned inward, and does not extend over adjacent surface units.
- Do Not Soak Removable Heating Elements – Heating elements should never be immersed in water.

IMPORTANT INSTRUCTIONS

- Do Not Cook on Broken Cook-Top – If cook-top should break, cleaning solutions and spillovers may penetrate the broken cook-top and create a risk of electric shock. Contact a qualified technician immediately.
- Clean Cook-Top With Caution – If a wet sponge or cloth is used to wipe spills on a hot cooking area, be careful to avoid steam burn. Some cleaners can produce noxious fumes if applied to a hot surface.

USING THE APPLIANCE

- Switch the heating zones off after using.
- Keep an eye on the cooking using grease or oils: that may quickly ignite.
- Be careful not to burn yourself while or after using the appliance
- Make sure no cable of any fixed or moving appliance contacts with the glass or the hot saucepan.
- Magnetic objects (credit cards, floppy disks, calculators) should not be placed near the appliance.
- Metallic objects such as knives, forks, spoons and lids should not be placed on the cooktop surface since they can get hot.
- In general do not place any metallic object except heating containers on the glass surface. In case of untimely engaging or residual heat, this one may heat, melt or even burn.
- Never cover the appliance with a cloth or a protection sheet. This is supposed to become very hot and catch fire.
- This appliance can be used by children aged from 8 years and above and persons with reduced physical, sensory or mental capabilities or lack of experience and knowledge if they have been given supervision or instruction concerning use of the appliance in a safe way and understand the hazards involved.
- Children shall not play with the appliance.
- Cleaning and user maintenance shall not be made by children without supervision

PRECAUTIONS IN CASE OF APPLIANCE FAILURE

- If a defect or malfunction is noticed, switch off the appliance and turn off the electrical supply.
- If the ceramic glass is cracked or fissured, you must unplug the appliance and contact the service department.
- Repair must be done by qualified technicians. Do not open the appliance by yourself.
- **WARNING:** If the surface is cracked, switch off the appliance to avoid the possibility of electric shock.

OTHER PRECAUTIONS

- Make sure that the cookware is always centered on the cooking zone. The bottom of the pot should cover as much as possible of the cooking zone.
- Do not place aluminium or synthetic material containers on the cooktop: they could melt on residual hot cooking zones.
- For the users of cardiac pacemakers, the magnetic field may influence the operation. We recommend getting information from the retailer or the doctor.
- NEVER try to extinguish a fire with water, but switch off the appliance and then cover flame e.g. with a lid or a fire blanket.

THE USE OF EITHER POOR QUALITY POTS OR ANY INDUCTION ADAPTOR PLATE FOR NON-MAGNETIC COOKWARE RESULTS IN A WARRANTY BREACH.

IN THIS CASE, THE MANUFACTURER CANNOT BE HELD RESPONSIBLE FOR ANY DAMAGE CAUSED TO THE COOKTOP AND/OR ITS ENVIRONMENT.

3. DESCRIPTION

Technical characteristics



Total Power	Zones position	Diameter	Nominal Power*	Booster*	Mini Detection Diameter
7400 W	Front left	180 mm	1850 W	3000 W	100 mm
	Rear left	180 mm	1850 W	3000 W	100 mm
	Center	260 mm	2600 W	5500 W	110 mm
	Rear right	220 x 180 mm	2300 W	3700 W	110 mm
	Front right	220 x 180 mm	2300 W	3700 W	110 mm

* The given power may change according to the dimensions and material of the pan

Total power max 11 100 W

4. USE OF THE APPLIANCE

Before the first use

- *Clean your cooktop with a damp cloth, and then dry the surface thoroughly. Do not use detergent; this can create a blue-tinted color on the glass surface.*
- *Remove all labels and self-adhesives from the ceramic glass.*
- *Pot compatibility*

The pan has to be induction compatible.

All ferromagnetic pans are recommended. You can check this with a magnet – if the magnet holds to the pot, the pot is likely to be induction compatible. Compatible pots are usually cast iron and steel pans, enamelled pans, stainless-steel pans with ferromagnetic bottoms...

Excluded: copper, pure stainless-steel, aluminium, glass, wood, ceramic, stoneware,...

When you buy a pot, stick to the one that have the induction compatible logo

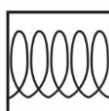

Induction

The induction heating zone adapts automatically to the size of the pan. With a diameter that is too small, the pan doesn't work. This diameter varies in function of the heating zone diameter (Cf page 9).

If the pan is not adapted to the induction cooktop , the display will show .

- *Pot flatness*

For better efficiency and function, pot should always have a flat bottom.

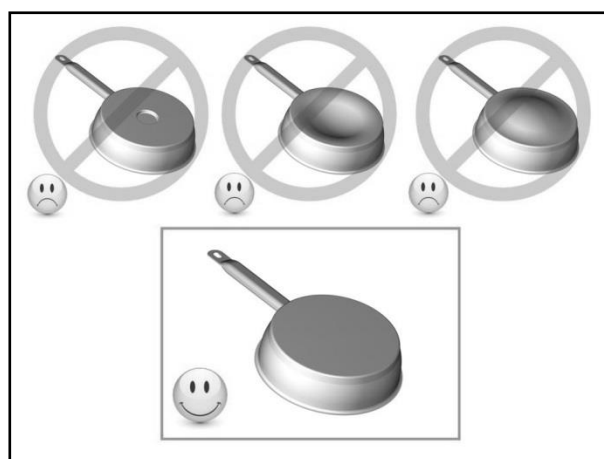

- *Noise*

Certain pans can make noise when they are placed on an induction cooking zone. Some pans are noisier than others. When used at maximum power, the unit will become noisier. The pan will be vibrating and the cooling fan will start.

This noise is normal, and does not mean that there is something wrong with the appliance, nor does it influence its function.

- *Cooling fan*

The cooling system is fully automatic. The cooling fan starts at a low speed when the calories generated by the electronic system reach a certain level. The ventilation starts its high speed level when the cooktop is intensively used. The cooling fan reduces its speed and stops automatically when the electronic circuit has cooled down enough.

Display

Each knob controls a cooking zone, and operation indicators displayed in the display area.



Display	Designation	Description	See page
	Cooking level	Selection of the cooking level.	12
	No pan detection	No pan or inadequate pan	10 - 12
	Booster	Booster is activated	13
	Heat accelerator	Automatic cooking	14
	Keep warm	Maintain automatically 150° F (70°C).	15
	Keep warm	Maintain automatically 201°F (94°C).	15
	Residual heat	The indicated heating zone is hot	15
	Lock	Knobs are locked	16
	Error message	Electronic failure	

Operations

- **Start-up / switch off a heating zone:**



1- Place a pot on the cooking zone

(In case you try to start without a pot on the cooking zone, the display will show  and the unit won't start)



2- To start, Turn the knob corresponding with the desired zone to the right



3- The display of the corresponding zone will show up

4- You can now adjust to the desired amount of power ( to )
(the values below are indicative)

1 to 2	Melting Reheating	Sauces, butter, chocolate, gelatine Dishes prepared beforehand
2 to 3	Simmering Defrosting	Rice, pudding, sugar syrup Dried vegetables, fish, frozen products
3 to 4	Steam	Vegetables, fish, meat
4 to 5	Water	Steamed potatoes, soups, pasta, fresh vegetables
6 to 7	Medium cooking Simmering	Meat, lever, eggs, sausages Goulash, roulade, tripe
7 to 8	Cooking	Potatoes, fritters, wafers
9	Frying, roasting Boiling water	Steaks, omelettes, fried dishes Water
P	Frying, roasting, Boiling water	Scallops, steaks, Boiling significant quantities of water

Note : If the pan is removed from the heating zone the operation is stopped. The display shows . The symbol  disappears when the pan is put back to the heating zone. The cooking continues with the power level set before.

After use, switch the heat element off by bringing back the knob to .

Do not leave the pan detection active.

- **Booster function**

Booster [P] gives a boost to the selected heating zone. When this function is activated, the heating zones work for 10 minutes at an ultra- high speed. This is meant to be used for heating large quantities of water very quickly (e.g. pasta).

To activate the boost function :

1. Set the knob of the desired zone to **9**.



2. Hold the knob to the far right for 2 seconds until display shows **P**.



Hold 2 seconds

IMPORTANT : Power management:

The cooktop has a maximum potential power. When the Booster function is activated, the electronic system automatically reduces the power level of another heating zone, if it is exceeding the maximum potential. The display blinks [9] during a few seconds, then shows the maximum of power allowed.

You can only activate the boost power on one of the left hand side and one of the right hand side cooking zones at the same time.



- **Heat accelerator**

All the cooking zones are equipped with heat accelerator function. The cooking zone starts at full power for a certain amount of time, then automatically reduces its power until it reaches the pre-selected power level.

1. Turn the knob to the far left until you reach the stop, and hold 2 seconds until display shows .



Hold 2 seconds

2. Turn the knob to the right and select the desired power level (For example here ).  and  are blinking, showing the function is activated.



3. The power is automatically adjusted, so the pot gets to temperature faster. Touching the knob will cancel the function.

- **“Keep warm” Function**

This function allows the cooking zones to reach and automatically maintain a temperature of 150° F (70°C) or 201°F (94°C)., this avoids liquids flowing over and pans burning.

1. The  (Keep warm 150° F) and  (Keep warm 201° F) are slightly before the  position of the knob.
2. **Turn the knob slightly to the right to reach those function until  or  shows on display.**



- **Control panel locking**

To avoid engaging or modification of the setting of the cooking zones , particularly when cleaning, the control panel can be locked.

1. Turn the front left and rear left knob simultaneously to the left and hold for 3s.
2.  shows on the display and unit is locked.



3. To unlock repeat the same operation (Turn the front left and rear left knob simultaneously to the left and hold for 3s.)

- **Residual heat indication**

WARNING: Although the cooking surface is not producing any heat, the hot bottom pots and pans will conduct heat to the glass. After cooking, used zones will remain hot. **There are risks of burns and fire.**

Heat sensors are located underneath the cooking surface, and  will be displayed on cooking zones that remain hot.

Do not touch the heating zones and do not put any heat sensitive objects on them, as long as the residual heat indicators are switched on.

The symbol  disappears when the heating zones can be touched without danger.

5. MAINTENANCE AND CLEANING

- **To prevent damaging your appliance:**
 - Raw pan bottoms or damaged saucepans (not enamelled cast iron pots,) may damage the ceramic glass.
 - Sand or other abrasive materials may damage ceramic glass.
 - Avoid dropping objects, even little ones, on the vitroceramic.
 - Make sure that the ventilation of the appliance works according to the manufacturer's instructions.
 - Do not put or leave empty saucepans on the cooktop.
 - Sugar, synthetic materials or aluminium sheets must not contact with the heating zones. These may cause breaks or other alterations of the vitroceramic glass by cooling: switch on the appliance and take them immediately out of the hot heating zone (be careful: do not burn yourself).
 - Never place a hot container on the control panel.
 - **WARNING:** Danger of fire: do not store items on the cooking surface.
 - If a drawer is situated under the embedded appliance, make sure the space between the content of the drawer and the inferior part of the appliance is large enough (2 cm). This is essential to guaranty correct ventilation.
 - Never put flammable objects (ex. sprays) into the drawer situated under the cooktop. The eventual drawers must be resistant to heat.

- **Cleaning**

- **Warning** : Switch off the appliance before cleaning.
- Do not clean the cooktop when the glass is too hot: risk of burns.
- Remove small spots with a damp cloth using dishwashing liquid diluted in a little water. Then rinse with cold water and dry the surface thoroughly.
- Highly corrosive or abrasive detergents and cleaning equipment likely to cause scratches must be avoided at all costs.
- Never use a steam cleaner or high-pressure washer.
- Do not use objects that might scratch the ceramic glass.
- Ensure that the pan is dry and clean and that there is no dust on your ceramic cooktop or on the pan. The use of rough saucepans will scratch the surface.
- Spillages of sugar, jam, jelly, etc. must be removed immediately to prevent damaging the surface.

6. TROUBLESHOOTING GUIDE

<u>Problem</u>	
The cooktop or the cooking zone does not start:	<ul style="list-style-type: none"> • The cooktop is badly connected to the electrical network. • The safety fuse is cut off. • The lock function is activated. • The sensitive touch keys are covered with grease or water. • An object is put on a sensitive touch key.
One or all cooking zone(s) are cut off:	<ul style="list-style-type: none"> • The safety system functioned. • This system works when you forgot to switch off the cooking zone. • One or more sensitive touch keys are covered. • The pan is empty and its bottom overheated. • The cooktop also has an automatic reduction of the power level (see Booster function), and is switched off automatically when there is a possibility of overheating.
The display area shows [U]:	<ul style="list-style-type: none"> • There is no pan on the cooking zone. • The pan is not compatible with induction. • The pan's bottom diameter is too small.
The display area shows [E]:	<ul style="list-style-type: none"> • The electronic system is defective. • Disconnect and reconnect the cooktop. • Call service.
The ventilation system is still working after switching off the cooktop:	<ul style="list-style-type: none"> • This is not a failure, the fan continues to protect the electronic device. • The fan stops automatically.
The automatic cooking system does not start:	<ul style="list-style-type: none"> • The cooking zone is still hot [H]. • The highest Booster level is set [9].
The display area shows [U]:	<ul style="list-style-type: none"> • See chapter "Keep warm".
The display area shows [] or [Er03]:	<ul style="list-style-type: none"> • An object or liquid covers the control keys. The symbol disappears as soon as the key is released or cleaned.
The display area shows [E2]	<ul style="list-style-type: none"> • The cooktop is overheated, let it cool and then turn it on again.
The display area shows [E8]	<ul style="list-style-type: none"> • The air inlet of the ventilator is obstructed, release it.
The display area shows [U400]	<ul style="list-style-type: none"> • The cooktop is not connected to the network. Check the connection and reconnect the cooktop.
The display area shows [Er47]	<ul style="list-style-type: none"> • The cooktop is not connected to the network. Check the connection and reconnect the cooktop.

7. INSTALLATION INSTRUCTIONS

• Fitting – installing

Warning

- Do not change or alter the appliance.
- Do not use any extension cable to connect it.
- The appliance is not intended to be operated by means of external timer or separate remote control system.
- **The installation and connecting of the appliance must be done by approved specialists. The manufacturer cannot be responsible for damage caused by installation or connecting errors.**
- **To be used, the appliance must be well-equipped and installed in a kitchen unit and an adapted and approved work surface.**
- **This domestic appliance is exclusively for the cooking of food, to the exclusion of any other domestic, commercial or industrial use.**
- The cabinetry or the support in which the cooktop is to be fitted, as well as the edges of cabinet, the laminate coatings and the glue used to fix them, must be able to resist temperatures of up to 100 °C.
- The strips on the wall edges need to be heat-resistant.
- If a drawer is placed under the unit, avoid putting flammable objects in this drawer (e.g. sprays) or non-heat-resistant objects.
- Materials which are often used to make countertops expand on contact with water. To protect the cut-out edge, apply a coat of varnish or special sealant. It is recommended to apply an adhesive joint around the cooktop to prevent any leakage into the supporting cabinetry. The gasket guarantees a correct seal when used in conjunction with smooth worktop surfaces.
- The space between the cooktop and the range hood placed above must respect the specifications of the hood manufacturer.
- The connection cable cannot be subjected to mechanical constraint (e.g. a drawer) after construction.
- **WARNING:** Use only cooktop guards designed by the manufacturer of the cooking appliance or indicated by the manufacturer of the appliance in the instructions for use as suitable or cooktop guards incorporated in the appliance. The use of inappropriate guards can cause accidents.

• **Standard installation dimensions**

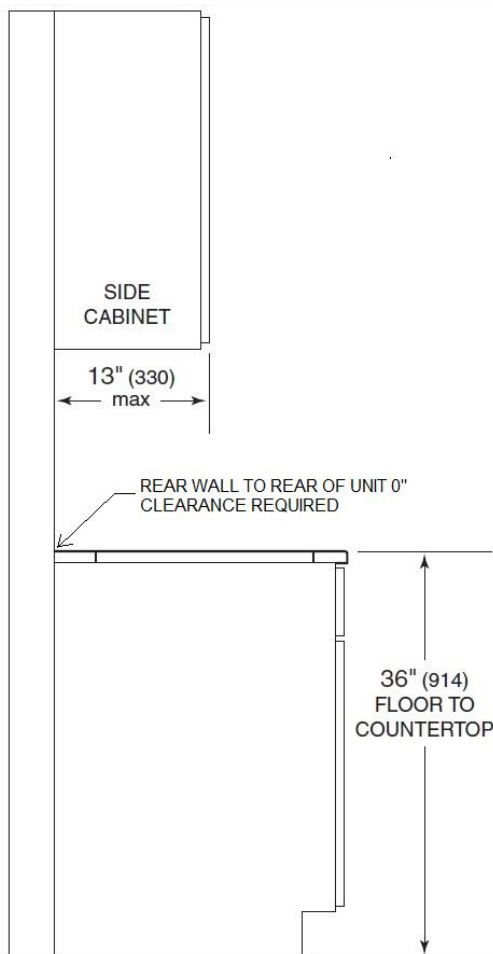

SIDE VIEW

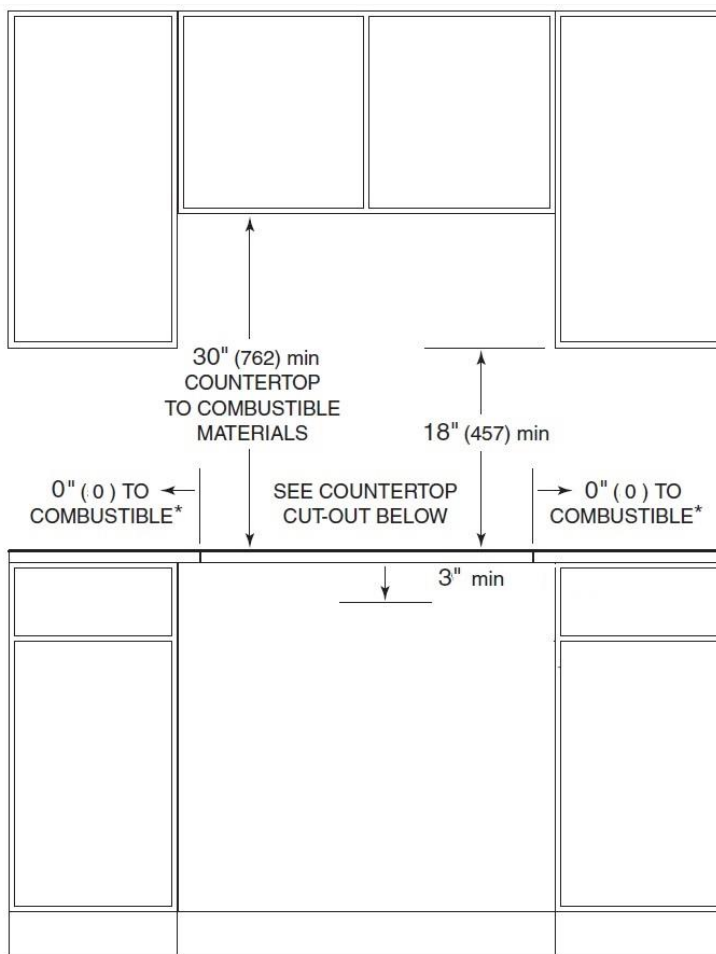

FRONT VIEW

UNIT CAN BE INSTALLED WITH 0" CLEARANCE FROM REAR AND SIDE WALLS. RECOMMENDED INSTALATION IS TO CENTER UNIT FRONT TO BACK IN COUNTERTOP

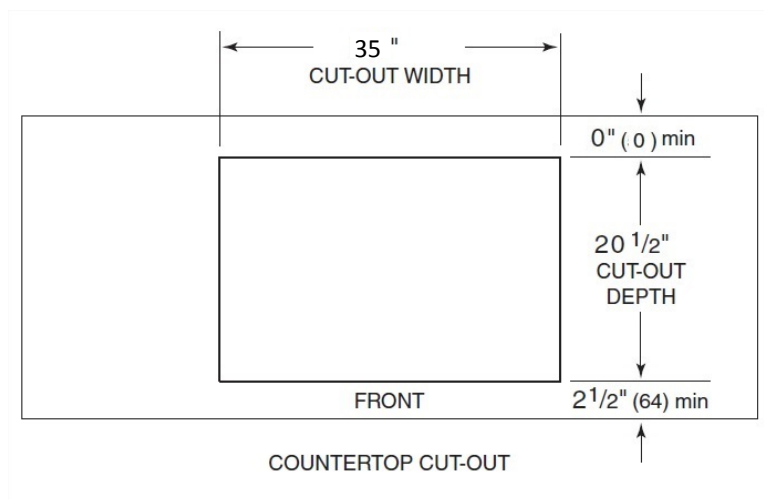

COUNTERTOP CUT-OUT

Warning: The appliance cannot be used above a dishwasher or a dryer or a non-ventilated oven: steam may damage the electronic appliances.

Electrical connection

- The installation of this appliance and the connection to the electrical network should be entrusted only to an electrician who is aware of the normative regulations and respects them scrupulously.
- The electrical parts should always be protected after the installation.
- The appliance should be connected using a multipolar circuit breaker.
- If the appliance is not fitted with an accessible plug, disconnecting means must be incorporated in the fixed installation, in accordance with the installation regulations.
- The inlet hose must be positioned so that it does not touch any of the hot parts of the cooktop or oven.

Caution!

This appliance must only be connected to a network 230 VAC~ 50/60 Hz. Always connect the ground wire

Mains	Connection	Cable diameter	Protection calibre
230 VAC~ 50/60Hz	2 Phases	3 x 10 AWG (supplied)	50 A

Connection of the cooktop

Connect the black and white wires to the 2 phases (230 VAC), and the green wire to the ground.

Caution! Ensure that the cables are correctly inserted and tightly screwed down.

We cannot be held responsible for any incident resulting from incorrect connection or which could arise from the use of an appliance which has not been earthed or has been equipped with a faulty ground connection.

Position of Nameplate

Nameplate is located under the appliance, as shown on the picture below.

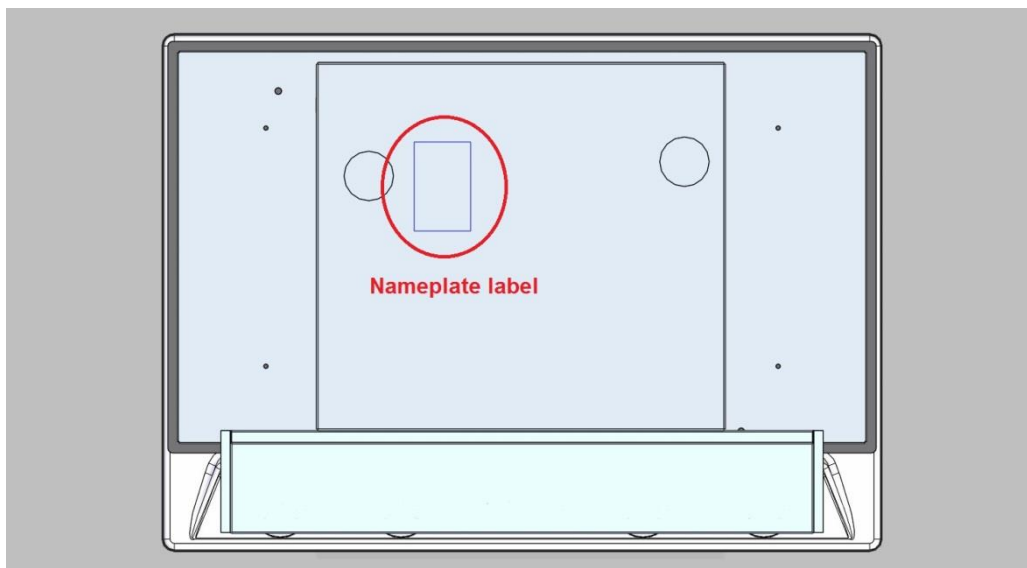

WARRANTY

WHAT IS COVERED?

Initial Seven (7) Day Limited Warranty.

Bluestar warrants that all cosmetic components of its Products will, under normal use and service, be free from defects in materials and workmanship for a period of seven (7) calendar days from the date of delivery (the "Warranty Period") to the original retail purchaser. For purposes of this Limited Warranty, cosmetic components include top grates, ring grates, plate rail, kick panel, body sides, glass, control panel, door panel, back guards, oven seals, light bulbs, and enameled parts. All warranty claims for cosmetic items must be reported immediately within seven calendar days of delivery or such claims will not be honored. Please refer to your installation checklist to activate your limited warranty.

One (1) Year Limited Warranty.

Bluestar warrants that all functional components (except cast iron burner tops) of its Products will, under normal use and service, be free from defects in materials and workmanship for a period of one (1) year from the date of delivery (the "Warranty Period") to the original retail purchaser. For purposes of this Limited Warranty, functional components include all components of the Product other than the cosmetic components covered by the initial seven day limited warranty and the cast iron burner tops covered by the 10 year limited warranty. Please refer to your installation checklist to activate your limited warranty. Failure to send a complete and accurate copy of the installation checklist within 15 days of installation will invalidate your limited warranty.

Please refer to your installation checklist to activate your limited warranty. Failure to send a complete and accurate copy of the installation checklist within 15 days of installation will invalidate your limited warranty.

If any Product fails to comply with the foregoing Limited Warranties during the applicable Warranty Period, Bluestar will, at its option, either (i) pay the reasonable labor and material costs to have the Product repaired by a factory authorized service agent; (ii) replace the Product or defective component of the Product; or (iii) if in Bluestar's sole judgment circumstances are such as to preclude the remedying of any breach of warranty by repair or replacement, then Bluestar will refund the purchase price paid by the original purchaser. All repairs or replacement service must be performed by a factory authorized service agent. Additionally, all Products must be accessible for service in the home and must be accessible via public highways within 100 miles roundtrip of a factory authorized service agent. The purchaser will be responsible for the cost of additional mileage, non-standard service and special equipment to remove the Product for service so that there is accessibility on all sides of the Product.

The repair or replacement of the Product or the return of the purchase price will be the purchaser's sole and exclusive remedy for any breach of this Limited Warranty or any other claim with respect to the Product, including those claims based on contract, warranty, or tort. In no event will Bluestar's liability for any defective Product exceed the purchase price thereof. This exclusive remedy will not be deemed to have failed of its essential purpose so long as Bluestar's is willing and able to repair and/or replace defective Products in the manner prescribed herein or to provide a refund if, in Bluestar's sole judgment, repair or replacement is not feasible or appropriate under the circumstances.

WHAT IS NOT COVERED?

original retail purchasers in the continental United States and Canada. This Limited Warranty is not transferable to any subsequent purchasers or users. If any implied warranties arise under any applicable law (including, but not limited to, implied warranties of merchantability and fitness for particular purpose), then the duration of those implied warranties will last only as long as the express warranties stated above. Bluestar will not under any circumstances be liable for any special, indirect, incidental or consequential damages of any kind, including but not limited to loss of business or profits, loss of use, or installation or removal costs. Nor will Bluestar be responsible for any shipping costs related to the repair or replacement of any Product under this Limited Warranty. Some States do not allow the exclusion or limitation of incidental or consequential damages or limitations on how long implied warranties last, so the above limitations may not apply to you.

This Limited Warranty does not apply to commercial usage or to any Products installed in any non-residential settings such as day cares, bed and breakfasts, hotels, nursing homes, churches, etc. This Limited Warranty also does not cover, and specifically excludes, chipping porcelain, calibrations and normal adjustments after installation and setup, burner adjustments, normal care and maintenance, cleaning of parts, shipping damage, discoloration of the griddle, rust, gasket materials, ceramic materials, and fuses.

Additionally, there is no warranty coverage for any Products that fail or have been damaged due to alterations or modifications; abuse; misuse; neglect; improper installation, instruction, handling, operation, maintenance or storage; accidental or intentional damage; normal wear and tear; unauthorized service or repairs, including unauthorized adjustments or calibrations performed on the Product; damage from natural disasters, fires, floods, earthquakes or other acts of God; loss of electrical power to the Product for any reason; alteration for outdoor use; damage due to the use of harsh chemicals (e.g., cleaning products improperly applied); or any other circumstances beyond Bluestar's control. This Limited Warranty is also invalid if the original factory installed serial number has been altered or removed from the Product.

The Purchaser is responsible for proper installation and normal care and maintenance of the Product. This warranty gives you specific legal rights, and you may also have other rights which vary from State to State.

OBTAINING WARRANTY SERVICE

All warranty claims must be reported to Bluestar Inc., 600 Arlington St., Reading, Pennsylvania 19611 prior to the expiration of the applicable Warranty Period. If a warranty claim relates to cosmetic parts, any such claim must be reported to Bluestar within seven (7) calendar days after the Product has been delivered. The purchaser must call the factory at the toll free 1-877-842-3269 to report a warranty claim or to obtain information about warranty service. If any warranty claim is not submitted as required by this Limited Warranty, any such claim will be invalid and will not be honored. At the time the warranty claim is made, the purchaser must provide the model number of the Product, the serial number of the Product, proof of delivery, a description of the claimed defect, and proof of purchase of the Product, including the original retail receipt or invoice to establish the Warranty Period. Bluestar must also be given an opportunity to inspect any defective Product.

All warranty repairs must be performed by a factory authorized service agent. Service will be provided during normal business hours. The purchaser will be responsible for any labor performed at overtime or premium rates. The purchaser is also responsible for making the Product accessible for service.

PERFORMANCE CHECKLIST

This checklist has been developed to assure proper installation of your appliance
To validate your warranty you must mail or fax this form and a copy of your receipt to:
Warranty Department, Bluestar, 328 June Ave. Blandon, PA 19510

Customer Information (Please Print)

Product Information (Please Print)

Name: _____ Model No: _____
Address: _____ Serial No: _____
City: _____ Purchase Date: _____
State, Zip Code: _____ Installation Date: _____
e-mail: _____ Installer's Name: _____
Telephone: _____ Company: _____
Dealer: _____ Telephone: _____

CHECK ALL THAT APPLY

Appearance and Aesthetics

- Exterior
- Top section

Installation

- Proximity to cabinets
- Level
- Ventilation system
- Read User Manual
- Review safety instructions

Electrical Connection

- Correct voltage
- Grounded outlet
- Polarized outlet
- No GFCI

Controls

- Burner knobs
- Thermostats