

BLUESTAR 30" BSPRT RANGETOP SERIES

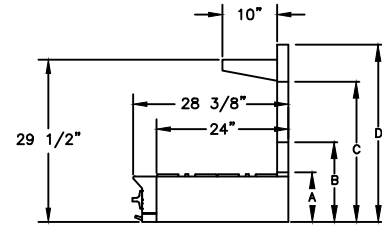
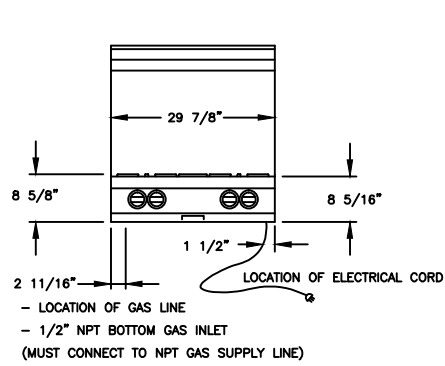

LOCATION OF ELECTRICAL CONNECTION
NOTE: A HOLE MUST BE DRILLED INTO THE BASE CABINET TO ACCEPT ELECTRICAL CORD.

LOCATION OF GAS LINE
NOTE: A HOLE MUST BE DRILLED INTO THE BASE CABINET TO ACCEPT GAS LINE.

- A - ISLAND TRIM HEIGHT - 9 1/16"
- B - 6" STANDARD BACKGUARD HEIGHT - 14-9/16"
- C - 17" BACKGUARD HEIGHT - 25-9/16"
- D - HIGH SHELF BACKGUARD HEIGHT - 32 5/16"

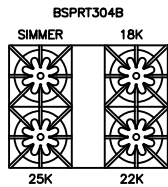

CONFIGURATIONS

SPECIFICATIONS:

- SIMMER BURNER RATING _ _ _ _ 9,000 BTU, 130°F
- TOP SUPERNOVA BURNER RATING _ _ 18,000 BTU
- TOP PRIMANOVA BURNER RATING _ _ 22,000 BTU
- TOP ULTRANOVA BURNER RATING _ _ 25,000 BTU
- CAST IRON INTERCHANGABLE GRIDDLE CHARBROILER SYSTEM
- ELECTRICAL REQUIREMENTS _ _ _ _ 120V, 60Hz, 15 AMPS, 1 PH (UNIT MUST BE ON A NON-GFI, DEDICATED OUTLET)
- OPERATING GAS PRESSURE _ _ _ _ NAT: 5.0" WC
LP: 10.0" WC
- INSTALLATION CLEARANCE _ _ _ _ 0" SIDE CABINET
0" BACK WALL

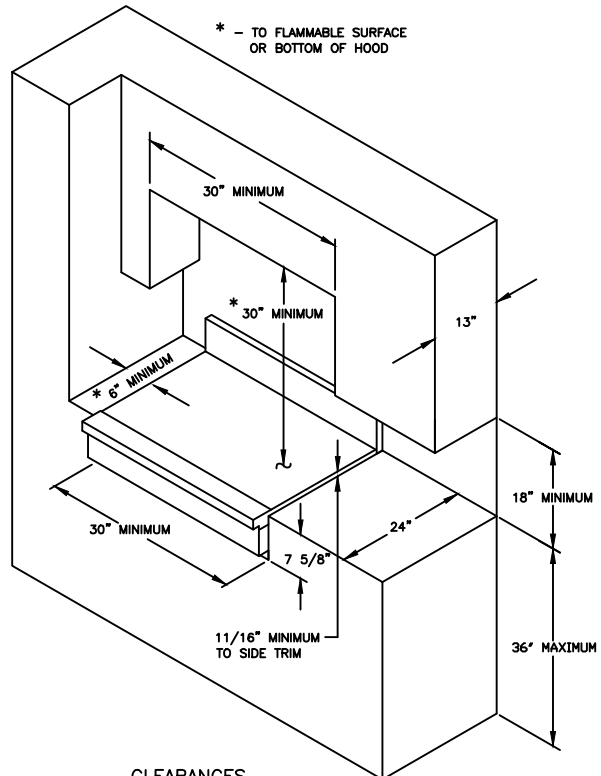

CLEARANCES

VISIT www.bluestarcooking.com FOR CUSTOM CONFIGURATIONS