

RMIP SERIES INSERT

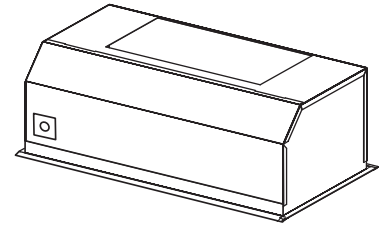

Especially designed to be installed in custom hood for use over residential commercial-style cooking surfaces.

A complete installation requires several optional components. Refer to page 2 when planning your installation.

FEATURES

- Cabinet mount – custom application
- Widths: 33", 45"
- Halogen lighting (33" – 2 x 50 watt; 45" – 3 x 50 watt PAR20) Lamps not included
- Controls: rocker switches for lighting and on-off, knob for infinite speed
- Heat Sentry™ turns blower ON to HIGH speed when excess heat is detected

OPTIONS

- Custom hood liners (RML33 or RML45 Series):
Widths - 36", 42", 48", 54" and 60"
Adjustable depth - see liner spec. sheet for details
Stainless Steel construction - protects custom hood base and wipes clean easily
- Dishwasher-safe stainless steel baffle filters RBFIP Series
- Backsplash (RMP Series):
Widths - 36", 42", 48", 60"
Stainless Steel construction - protects back wall and wipes clean easily
- RMIPWC Remote Control: With Stainless Steel faceplate, to fit any décor.

INSERT SPECIFICATIONS

- 120 Vac, 60 Hz
- Amps (without blower): 0.8 (RMIP33) 1.3 (RMIP45)
- For indoor use only.

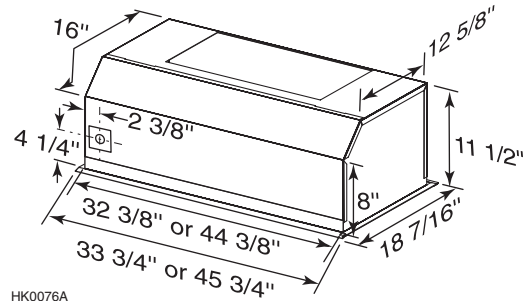

HK0076A

Mount insert so bottom of custom hood is 24" to 30" above cooking surface.

Custom Hood Liner
RML33 or RML45 Series

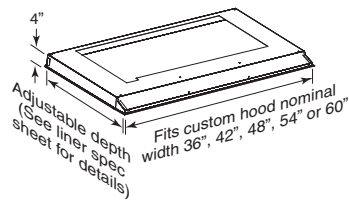

Baffle Filters
RBFIP Series

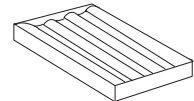

Backsplash
RMP Series

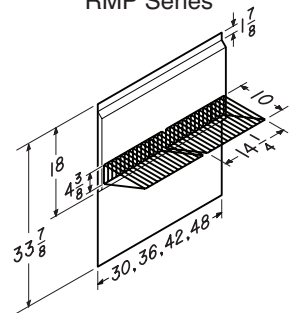

RMIPWC Remote Control

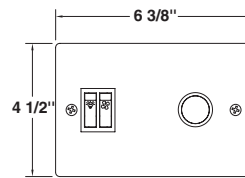

Broan-NuTone LLC Hartford, Wisconsin www.broan.com 800-558-1711
Broan-NuTone Canada Mississauga, Ontario www.broan.ca 877-896-1119

REFERENCE	QTY.	REMARKS	Project
			Location
			Architect
			Engineer
			Contractor
			Submitted by Date

RMIP MOUNTING

SIZE OF THE CUT-OUT

NOTE: If optional RML series liner is used, refer to installation instructions for size and location of the cut-out.

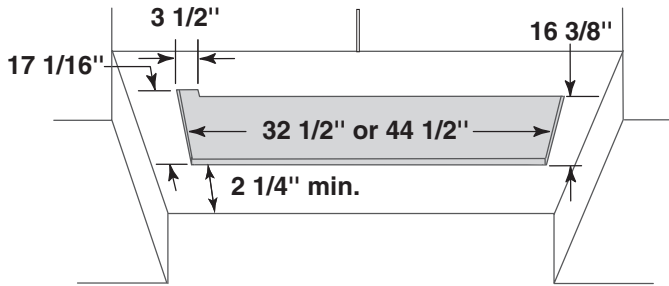

NOTE: The 3 1/2" notch must be cut only if the RMIPWC optional wall control will be installed.

Suggested Custom Hood Internal Framework

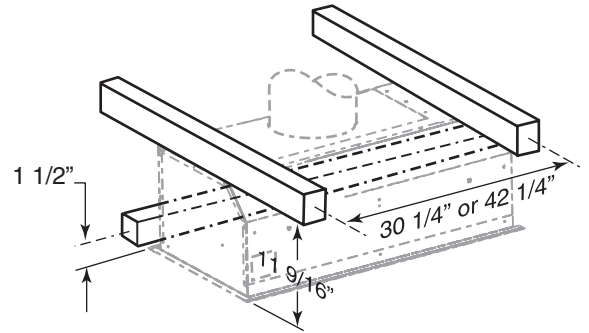

RMIP SERIES INSERTS BLOWER DUCTING POSITIONS

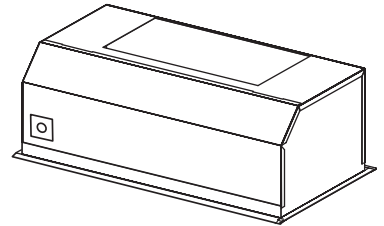

MODEL RMIP33 WITH P8 BLOWER (Vertical Outlet)

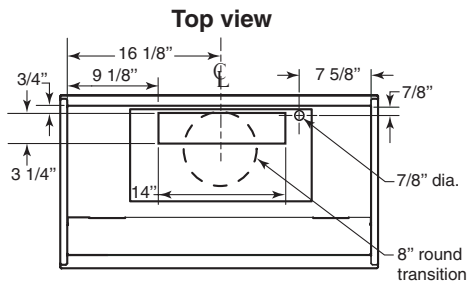

MODEL RMIP45 WITH P8 BLOWER (Vertical Outlet)

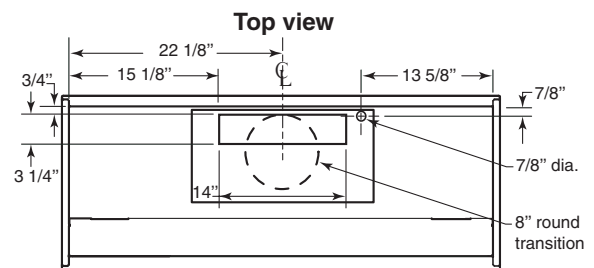

MODEL RMIP33 WITH P5 BLOWER (Vertical Outlet)

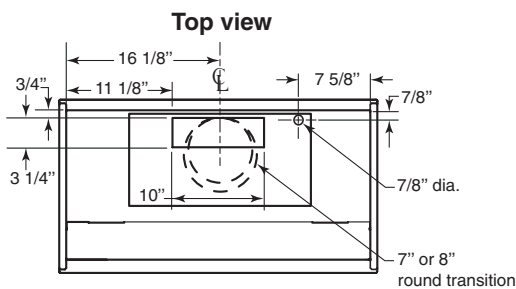

MODEL RMIP45 WITH P5 BLOWER (Vertical Outlet)

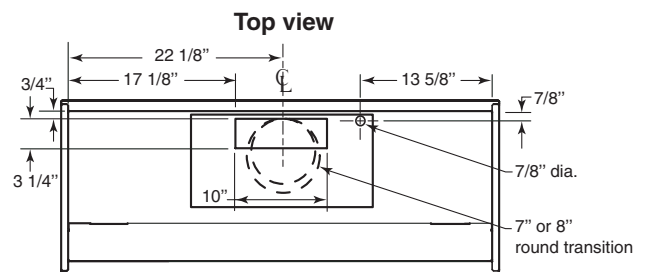

MODEL RMIP33 WITH 331H, 332H, 335, 336, HLB3, HLB6, HLB9 OR HLB11 BLOWER (Vertical Outlet)

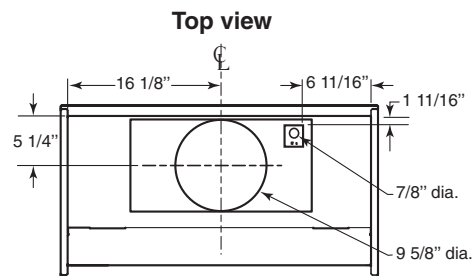

MODEL RMIP45 WITH 331H, 332H, 335, 336, HLB3, HLB6, HLB9 OR HLB11 BLOWER (Vertical Outlet)

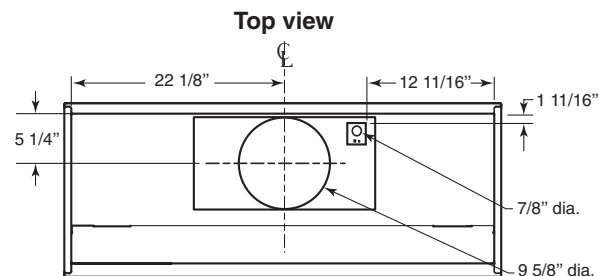

- RMIP33 AND RMIP45 INSERT SYSTEM - INTERIOR BLOWERS

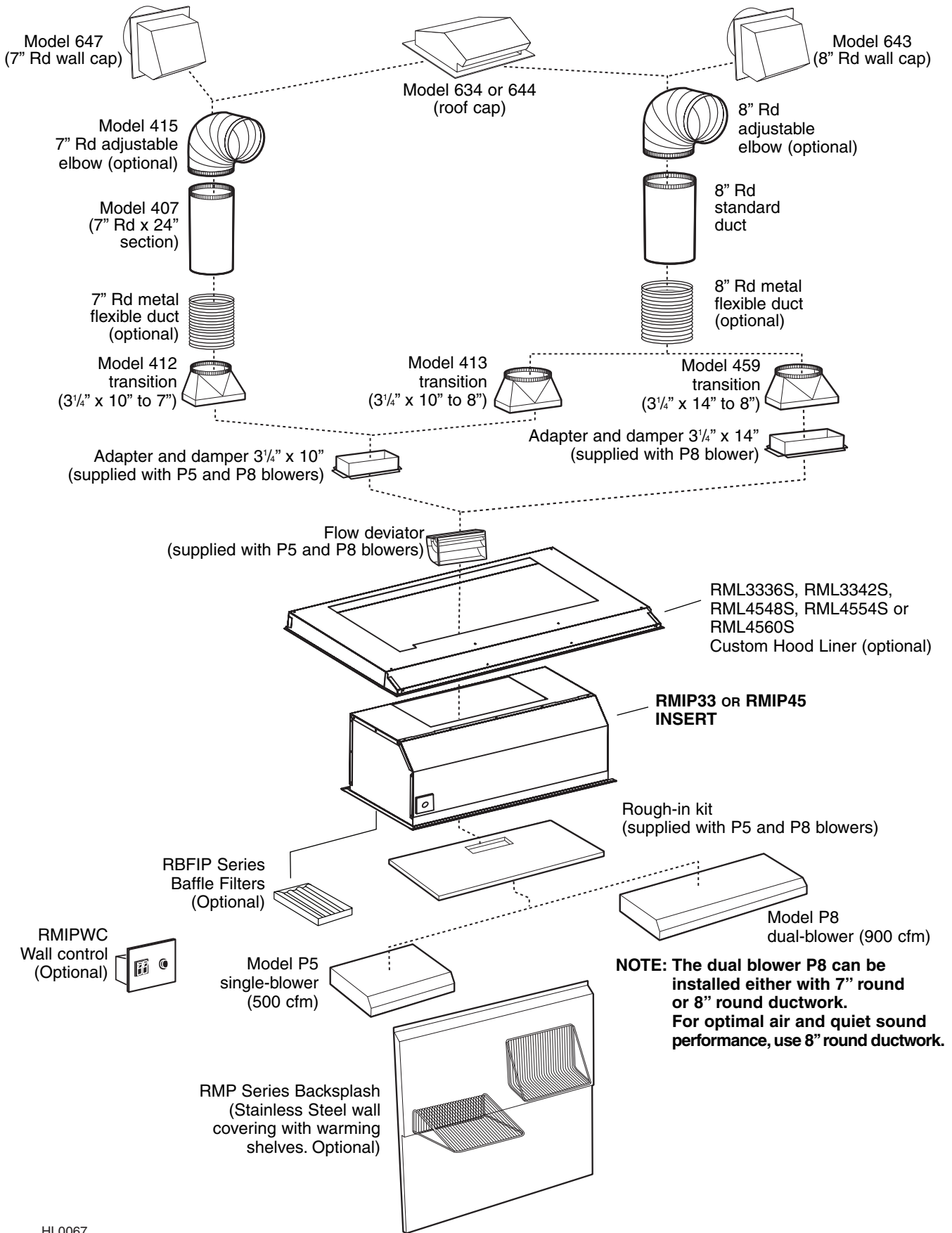

- RMIP33 AND RMIP45 INSERT SYSTEM - IN-LINE AND EXTERIOR BLOWERS

