

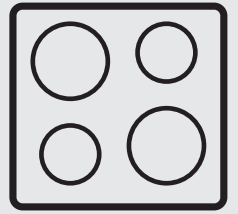

Thinking of you
Electrolux



EN INDUCTION COOKTOP

USE AND CARE GUIDE

Table of contents

Finding Information	2
Please read / save this guide	2
Keep a record for quick reference	2
Serial plate location	2
Questions?	2
Important Safety Instructions	3-4
Induction Cooktop Features	5-6
Getting Started	7-8
Induction cooktop characteristics	7
Use the correct cookware type	7
Selecting surface cookware.....	7
Cookware recommendations.....	8
Use the correct cookware size	8
Main Cooktop Controls	9
Using the touch controls.....	9
Cooktop main power pad	9
Keep warm pad	9
Controls lock pad.....	9
Minute timer pad.....	9
Setting Surface Controls	10-12
Cooking zone ON-OFF pad.....	10
Power level settings.....	10
Hot surface message.....	10
Setting "Power boost" feature.....	10
Preheat recommendations	10
Operating the cooking zones.....	11
Power Sharing	12
Operational Noises	12
General Care & Cleaning	13-14
Ceramic Glass Cooktop Cleaning & Maintenance	13
Cleaning Recommendations for Ceramic Glass Cooktop.....	13-14
Solutions to Common Problems	15-16
Entire Cooktop Does Not Operate.....	15
Cooktop Turns Off While Cooking	15
Cooking Zone Does Not Heat Food	15
Cooking Zone Heats Food	
Too Hot or Not Enough.....	15
Poor Cooking Results.....	15
Cooktop Zone Control Displays an error code	16
Cooking zones inner LEDs continuously rotating around digital display.....	16
Metal Marks on Ceramic Cooktop Glass	16
Scratches or Abrasions on Ceramic Cooktop Glass.....	16
Brown Streaks or Specks on Ceramic Cooktop Surface.....	16
Area of Discoloration with Metallic Sheen on Ceramic Cooktop Glass.....	16
Warranty Information	17

Please read & save this guide

Thank you for choosing **Electrolux**, the new premium brand in home appliances. This *Use & Care Guide* is part of our commitment to customer satisfaction and product quality throughout the service life of your new appliance.

We view your purchase as the beginning of a relationship. To ensure our ability to continue serving you, please use this page to record important product information.

Keep a record for quick reference

Purchase date

Electrolux model number

Electrolux serial number

Serial plate location

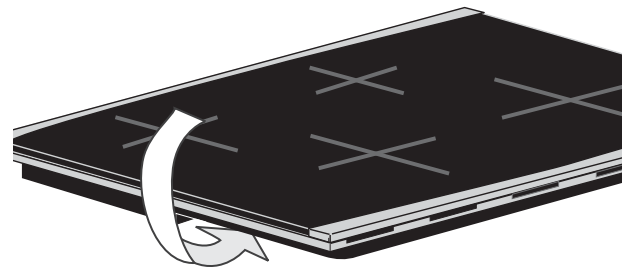

NOTE

Registering your product with Electrolux enhances our ability to serve you. You can register online at www.electroluxappliances.com or by dropping your Product Registration Card in the mail.

Questions?

For toll-free telephone support in the U.S. and Canada:

1-877-4ELECTROLUX (1-877-435-3287)

For online support and Internet production information visit <http://www.electroluxappliances.com>

Recognize safety symbols, words and labels

Safety items throughout this manual are labeled with a **WARNING** or **CAUTION** based on the risk type as described below:

WARNING

This symbol alerts you to situations that may cause serious body harm, death or property damage.

CAUTION

This symbol alerts you to situations that may cause bodily injury or property damage.

Read all of the following safety instructions before using this appliance:

- **This unit has been tested and found to comply with the limits for a class B digital device, pursuant to Part 18 of the FCC rules.** These limits are designed to provide reasonable protection against harmful interference in a residential installation. This unit generates, uses and can radiate radio frequency energy and, if not installed and used in accordance with the instructions, may cause harmful interference to radio communications. However there is no guarantee that interference will not occur in a particular installation. If this unit does cause harmful interference to radio or television reception, which can be determined by turning the unit off and on, the user is encouraged to try to correct the interference by one or more of the following measures:
 - » Reorient or relocate the receiving antennae.
 - » Increase the distance between the unit and receiver.
 - » Connect the unit into an outlet or a circuit different from that to which the receiver is connected.

CAUTION

Persons with a pacemaker or similar medical device should exercise caution using or standing near an induction unit while it is in operation, as the electromagnetic field may affect the working of the pacemaker or similar medical device. It would be advisable to consult your Doctor or the pacemaker or similar medical device manufacturer about your particular situation.

- **Remove all tape and packaging wrap before using the appliance. Destroy the carton and**

plastic bags after unpacking the appliance. Never allow children to play with packaging material.

- **Proper Installation.** Be sure your appliance is properly installed and grounded by a qualified technician in accordance with the National Electrical Code ANSI/NFPA No. 70 - latest edition in the United States, or CSA Standard C22.1, Canadian Electrical Code, Part 1, in Canada, and local code requirements. Install only per installation instructions provided in the literature package for this appliance.

Ask your dealer to recommend a qualified technician and an authorized repair service. Know how to disconnect the electrical power to the appliance at the circuit breaker or fuse box in case of an emergency.

- **User Servicing.** Do not repair or replace any part of the appliance unless specifically recommended in the manuals. All other servicing should be done only by a qualified technician to reduce the risk of personal injury and damage to the appliance.
- **Never modify or alter the construction of an appliance such as removal of panels, wire covers or any other permanent part of the product.**
- **Storage on Appliance.** Flammable materials should not be stored near or on the cooking surface. This includes paper, plastic and cloth items, such as cookbooks, plasticware and towels, as well as flammable liquids. Do not store explosives, such as aerosol cans, on or near the appliance. Flammable materials may explode and result in fire or property damage.
- **Do not leave children alone. Children should not be left alone or unattended in the area where an appliance is in use.** They should never be allowed to sit or stand on any part of the appliance.
- **Wear Proper Apparel.** Loose-fitting or hanging garments should never be worn while using the appliance. Do not let clothing or other flammable materials contact hot surfaces.

CAUTION

Do not store items of interest to children in the cabinets above the appliance. Children climbing on the cooktop to reach items could be seriously injured.

4 Important Safety Instructions

- **Do Not Use Water or Flour on Grease Fires.** Smother the fire with a pan lid, or use baking soda, a dry chemical or foam-type extinguisher.
- **When heating fat or grease, watch it closely.** Fat or grease may catch fire if allowed to become too hot.
- **Never Leave Prepared Food on the Cooking Zones.** Boilovers cause smoking and greasy spillovers that may ignite, or a pan that has boiled dry may melt or become damaged.
- **Protective Liners. Do not use aluminum foil to line any part of the cooktop.** Only use aluminum foil as recommended after cooking process, if used as a cover to be placed over the food. Any other use of aluminum foil may result in the risk of electric shock, fire or short circuit.

CAUTION

DO NOT TOUCH COOKING ZONES OR AREAS NEAR THESE SURFACES. Cooking Zones may be hot from residual heat even though they are dark in color. Areas near the Cooking Zones may become hot enough to cause burns. During and after use, do not touch, or let clothing or other flammable materials touch these areas until they have had sufficient time to cool.

WARNING

Never use your appliance for warming or heating a room.

- **Use Only Dry Pot holders.** Moist or damp pot holders on hot surfaces may result in burns from steam. Do not let the pot holders touch hot surface units. Do not use a towel or other bulky cloth instead of a pot holder.
- **Do Not Heat Unopened Food Containers.** Buildup of pressure may cause the container to burst and result in injury.
- **Know which touch key pads controls each surface of the Cooking Zones.**
- **Clean the appliance regularly to keep all parts free of grease that could catch fire.** Exhaust fan ventilation hoods and grease filters should be kept clean. Do not allow grease to accumulate on hood or filter. Greasy deposits in the fan could catch fire. When flaming food under the hood, turn fan on. Refer to hood manufacturer's instructions for cleaning.
- **Use Proper Pan Size.** This appliance is equipped with one or more Cooking Zones of different sizes. Select utensils having flat bottoms large enough to cover the Cooking Zones. The pan detection sensors will not allow the affected Cooking Zones to operate without a pan present.
- **Utensil Handles Should Be Turned Inward and Should Not Extend Over Adjacent Cooking Zones.** To reduce the risk of burns, ignition of flammable materials, and spillage due to unintentional contact with the utensil.
- **Glazed Cooking Utensils.** Only certain types of glass, glass/ceramic, ceramic, earthenware, or other glazed utensils are suitable for range top service without breaking due to the sudden change in temperature. Check the manufacturer's recommendations for cooktop use.
- **Ventilating hood.** The ventilating hood above your cooking surface should be cleaned frequently, so the grease from cooking vapors does not accumulate on the hood or filter.
- **Do Not Clean or Operate a Broken Cooktop.** If cooktop should break, cleaning solutions and spillovers may penetrate the broken cooktop and create a risk of electric shock. Contact a qualified technician immediately.
- **Clean Cooktop with Caution.** If a wet sponge or cloth is used to wipe spills on a hot cooking area, be careful to avoid a steam burn. Some cleaners can produce harmful fumes if applied to a hot surface.
- **Do Not Place Hot Cookware on Cold Cooktop Glass.** This could cause glass to break.
- **Do Not Slide Pan Across the Cooktop Surface.** They may scratch the cooktop surface.
- **Do Not Let Pans Boil Dry.** This may cause permanent damage in the form of breakage, fusion, or marking that can affect the ceramic-glass cooktop. (This type of damage is not covered by your warranty).

IMPORTANT SAFETY NOTICE

The California Safe Drinking Water and Toxic Enforcement Act requires the Governor of California to publish a list of substances known to the state to cause cancer, birth defects or other reproductive harm, and requires businesses to warn customers of potential exposure to such substances.

**SAVE THESE
INSTRUCTIONS FOR
FUTURE REFERENCES**

Induction Cooktop features

1. Left Rear Cooking Zone.
2. Center Cooking Zone.
3. Right Rear Cooking Zone.
4. Left Front Cooking Zone.
5. Right Front Double Cooking Zone.
6. Left Rear Cooking Zone Control Pads.
7. Left Front Cooking Zone Control Pads.
8. Main Cooktop Controls.
9. Center Cooking Zone Control Pads.
10. Right Front Cooking Zone Control Pads.
11. Right Rear Cooking Zone Control Pads.

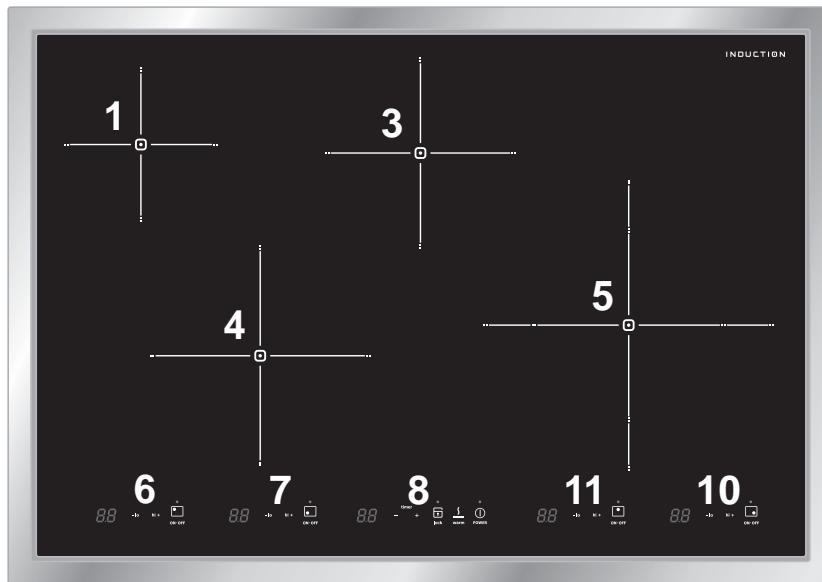

Figure 1 - 30" Model

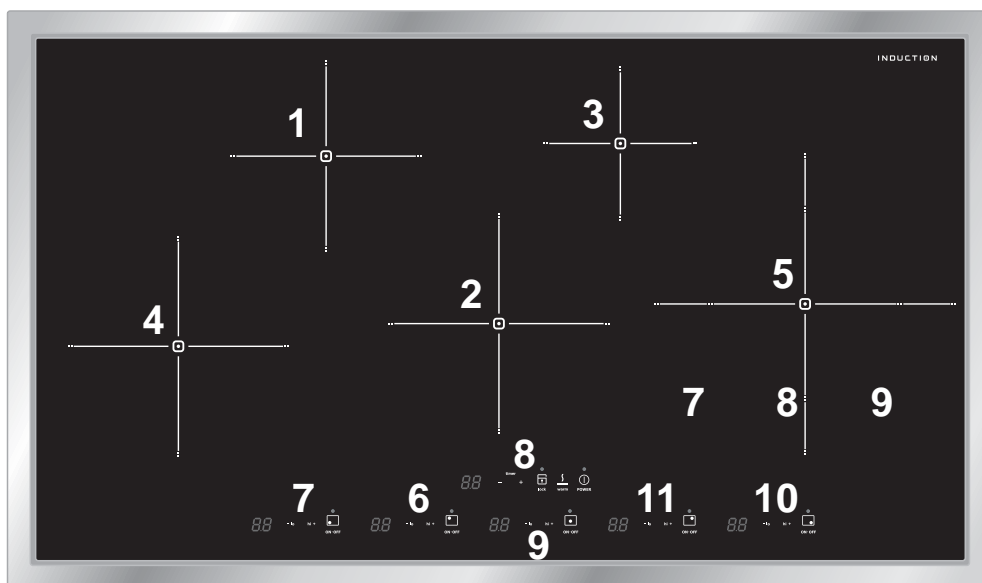
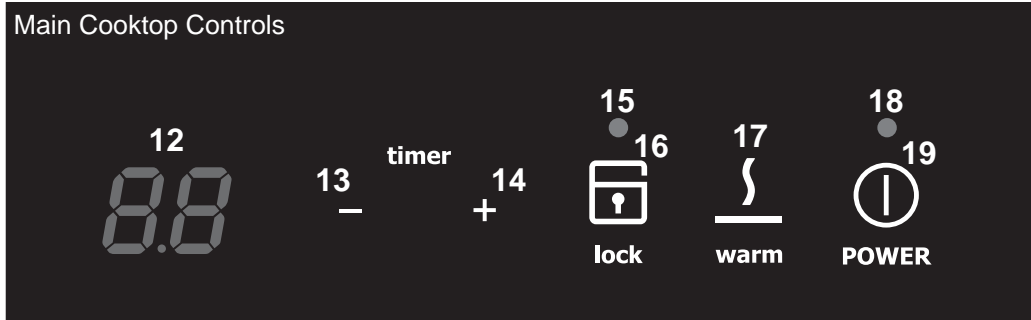

Figure 2 - 36" Model

Induction Cooktop features



- 12. Minute Timer Display Window (displays up to 99 minutes).
- 13. Minute Timer Setting " - " Pad.
- 14. Minute Timer Setting " + " Pad.
- 15. Controls Lock Indicator Light.
- 16. Controls Lock Key Pad.
- 17. Keep Warm Setting Key Pad.
- 18. Cooktop Power Indicator Light.
- 19. Cooktop Power Key Pad.

Cooking Zone Controls Pads

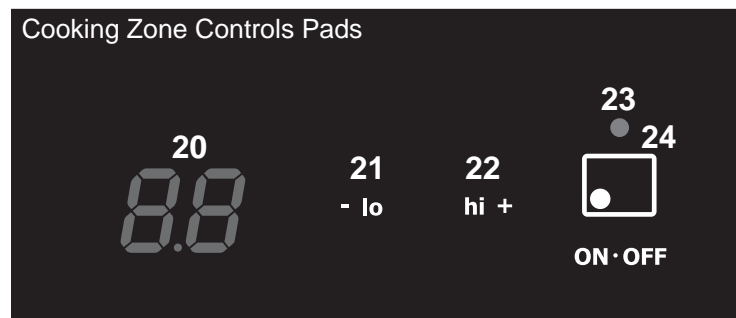

- 20. Element Power Level Display.
- 21. Element - lo Key Pad.
- 22. Element + hi Key Pad.
- 23. Element ON/OFF Indicator Light.
- 24. Element ON/OFF Key Pad.

Induction cooktop characteristics

A COOLER COOKTOP - A unique feature of the Induction Cooktop is whether turned ON or OFF, the cooktop surface remains cooler than standard ceramic cooktops.

CAUTION The Cooking Zones may appear to be cool while turned ON and after they have been turned OFF. The glass surface may be **HOT** from residual heat transferred from the cookware and burns may occur.

MAGNETIC DETECTOR - The coil sensor automatically detects whether the pan is magnetic and eliminates accidental “turn-ONs.”

PAN SIZE DETECTION - The pan recognition sensor automatically detects and adapts the Cooking Zones to the pan sizes in use.

EFFICIENT - Induction cooking heats faster while using less energy. Induction power levels are quick to boil and delicate when simmering.

Use the correct cookware type

The magnetic Cooking Zone sensors located below the cooktop surface require the use of cookware made with magnetic material in order to start the heating process on any of the Cooking Zones.

When purchasing pans, look for cookware specifically identified by the manufacturer for use with induction cooktops. If you are not sure, use a magnet to test whether the cookware type will work. If a magnet sticks to the bottom of the cookware, the material type is correct for induction cooking (See Fig. 1).

It is recommended to always use heavier high quality stainless steel cookware on your Induction Cooktop surface. This will greatly reduce the possibility of developing scratches on the ceramic surface.

Even quality cookware can scratch the cooktop surface, especially if cookware is slide over the ceramic cooktop surface without being lifted up. Over time sliding **ANY** type of cookware over the ceramic cooktop will likely alter the overall appearance of the cooktop. Eventually the buildup of scratches will make cleaning the surface difficult and degrade the overall appearance of the cooktop.

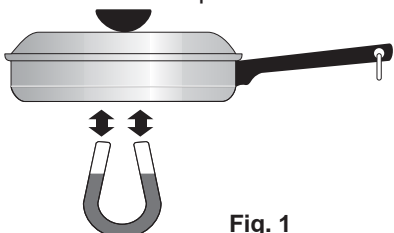

Fig. 1

Selecting surface cookware

The cookware used with the Induction Cooktop should have flat bottoms that make good contact with the entire surface of the Cooking Zone. Check for flatness by rotating a ruler across the bottom of the cookware (See Fig. 2). Be sure to follow all the recommendations for using cookware.

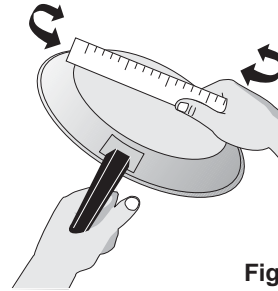

Fig. 2

Also remember to:

- Use cookware made with the correct material type for Induction Cooking.
- Use quality cookware with heavier bottoms for better heat distribution allowing for more even cooking results.
- The pan size should match the amount of food being prepared.
- **Do not let pans boil dry. This may cause permanent damage in the form of breakage, fusion, or marring that can affect the ceramic cooktop. (This type of damage is not covered by your warranty).**
- Do not use dirty pans with grease buildup. Always use pans that are easy to clean after cooking.

CAUTION

The Cooking Zones may appear to be cool while turned ON and after they have been turned OFF. The glass surface may be **HOT** from residual heat transferred from the cookware and burns may occur.

DO NOT SLIDE Cookware across the cooktop surface. Doing so may permanently damage the appearance of the ceramic cooktop.

DO NOT TOUCH HOT COOKWARE or **PANS** directly with hands. Always use oven mitts or pot holders to protect hands from burns.

Prior to using your cooktop for the first time, apply the recommended cooktop cleaning creme to the ceramic surface. Buff with a non-abrasive cloth or pad. This will make cleaning easier when soiled from cooking. The special cooktop cleaning cream leaves a protective finish on the glass to help prevent scratches and abrasions.

Cookware recommendations

Be sure to follow the following recommendations for using cookware as shown:

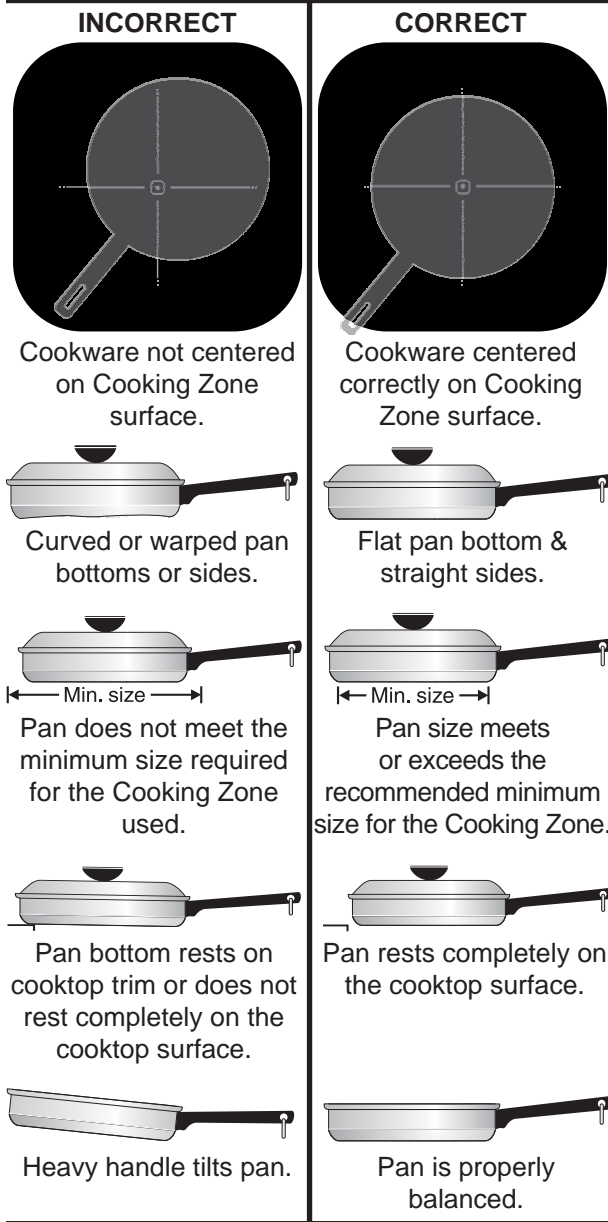

Fig. 1

NOTE

ANY one of the incorrect conditions listed above in Fig. 1 may be detected by the sensors located below the ceramic cooktop surface. If the cookware does not meet any of these conditions, one or more of the Cooking Zones will not heat indicated by a flashing power level in the digital display for that affected zone. Correct the problems before attempting to reactivate the cooktop.

Use the correct cookware size

The Cooking Zones available on the Induction Cooktop require a **MINIMUM** pan size to be used at each location. The cross (+) of each Cooking Zone is your guide to the correct **MINIMUM** pan size. The pan bottom must **FULLY** cover the cross for proper cooking to occur.

The outer dots at each Cooking Zone is helpful to determine the pan **MAXIMUM** size. After centering the cookware on the cooktop, make sure the cookware does not extend more than 1/2" beyond these dots on the Cooking Zone. The pan must make **FULL** contact on the glass surface without the bottom of the pan touching the metal cooktop trims.



Fig. 2

The Right Front Cooking Zone got a **MINIMUM** pan size much smaller than the other cooking zones to accommodate many pan sizes.



Fig. 3

NOTE

If a pan made of the correct material is centered properly on any of the active Cooking Zones but is **TOO SMALL**, the power level in the digital display will start flashing for the affected Cooking Zone Display and the pan will not heat.

Using the touch controls

The recommended way to use the touch pads on the cooktop is with your finger placed in the center of the touch pad. If the finger is not placed on the center of a pad, the cooktop may not respond to the selection made.

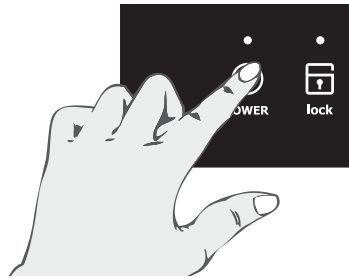

Fig. 1

Lightly contact the pad with the flat part of your entire fingertip. Do not just use the narrow end of your fingertip.

Cooktop main power pad

The Cooktop **POWER** key pad enables the entire Cooktop.

To power the cooktop, touch and hold the **POWER** key pad for 1/2 second. A beep will sound and the Power LED will glow (See Fig. 3). The cooktop will be in a ready mode for 10 seconds. If no other key pads are touched the Cooktop Main **POWER** will turn OFF automatically.

To turn the Main Power OFF touch Main **POWER** key. A beep will sound and the Power Indicator Light will turn OFF (See Fig. 2).



Fig. 2



Fig. 3

Keep warm pad

Use the WARM key pad to activate the Keep warm setting for any of the cooking zones. First, activate the zone by pressing the **ON-OFF** key pad, then touch the WARM key pad located in the Main cooktop controls area. LH (low heat) should appear in the corresponding cooking zone display (Fig. 5).



Fig. 4



Fig. 5

Controls lock pad

The Induction Cooktop may be locked in order to prevent the cooktop from accidentally being turned ON.

To turn ON the Controls Lock feature, make sure the unit is powered OFF

(See above, Figure 1) and that the timer is not active. Touch and hold the **LOCK** key pad for 3 seconds. A beep will sound and the Lock indicator light will glow (Fig. 7). Once locked, no other displays will glow and no Cooking Zones or timer will activate.

To turn the Controls Lock OFF, touch and hold the **LOCK** key pad for 3 seconds. A beep will sound, the Lock indicator light will turn OFF (Fig. 6) and the cooktop may be used normally. Remember to power ON the cooktop if it is needed right away.



Fig. 6



Fig. 7

Minute timer pad

The Minute Timer feature may be useful in the kitchen if a recipe calls for keeping track of time. This feature will keep track of time from 1 to 99 minutes. The timer display will begin to count down minutes once set.

To Set the Minute Timer feature, touch the **+** keypad listed over the word "timer".

Touching and releasing the **+** or the **-** key pads will increase or decrease the Minute Timer setting by 1 minute with each key press (up to 99 minutes). You may also hold the **+** or **-** key to slew the time to your designated time.

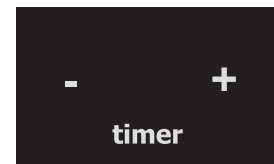

Fig. 8

Once the Timer LED displays the desired amount of time, release the **+** or the **-** Arrow key pads (Fig. 8). The Minute Timer will begin the countdown with remaining minutes. Once the Minute Timer reaches 1 minute, the timer will start counting down by seconds until 00 is reached. Once the Minute Timer reaches 00 a long beep will sound indicating that the time is up and the Timer display will flash 00.

To cancel or turn OFF the Minute Timer, Touch the **+** and **-** key pads at the same time or touch and hold either the **+** or **-** key pad and scroll to 00. The set time will disappear from the display indicating that the Minute Timer is no longer active.

Cooking zone ON·OFF pad

Each of the cooking zones have separate **ON·OFF** key pads. Once the Main Power key pad has been touched to activate the cooktop, touch the corresponding zone **ON·OFF** key pad



Fig. 1

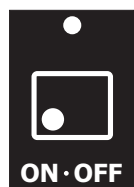

Fig. 2

once to activate the cooking zone needed. "0" will appear in the display and the **ON·OFF** indicator light will glow (Fig. 2). If the associated **hi+** or **lo-** key pad is not touched within 10 seconds, the request to turn the cooking zone ON will cancel and the cooktop will go back to ready mode.

To turn OFF a cooking zone, touch the **ON·OFF** pad once. The zone indicator light will turn OFF (Fig. 1).

Power level settings

Each cooking zone have separate power level displays. Once active, the zone will provide 15 power levels to choose from. These include 1 (Fig. 3), 1.5, 2, 2.5, 3, 3.5, 4, 4.5, 5, 5.5, 6, 6.5 (Fig. 4), 7, 8, 9 (Fig. 5). Each key pad touch (or just holding down the power level key pad) will scroll through all the available power levels for any cooking zone quickly.



Fig. 3



Fig. 4



Fig. 5

Hot surface message

Once any cooking zone has been used for cooking and turned OFF, and if the cooktop surface temperature on any of the cooking zone is still too HOT, HE (Fig. 6) will appear in the display of the affected cooking zone. The HE will continue to display if the temperature is still too HOT.



Fig. 6

CAUTION

The Cooking Zones may appear to be cool while turned ON and after they have been turned OFF. The glass surface may be HOT from residual heat transferred from the cookware and burns may occur.

Setting "Power boost" feature

Your induction cooktop is equipped with a Power Boost feature on each cooking zone. The Power Boost feature is used to bring large quantities of water or food to cooking temperature at the fastest speed possible. The Power Boost feature will give you up to 139% power output for a maximum of 10 minutes.



Fig. 7

To Turn ON the Power Boost Feature:

- Turn on the cooking zone you want to set to Power Boost then press the "+" key pad and the "Pb" message will be shown in the display (Fig. 7).

Preheat recommendations

When preheating a pan on the cooktop always watch carefully. Whenever using the cooktop the user should always pay attention to any items cooking and remain attentive until the cooking process is complete.

Keep in mind that induction may decrease the amount of time required to preheat the desired pan.

Operating the cooking zones

The Induction cooktop has four or five Cooking Zones designed for cookware of various sizes. Be sure to place cookware that meets the minimum and maximum pan size requirements for the Cooking Zone desired and is best for the amount of food being prepared. Place the cookware with the prepared food on the Cooking Zone **BEFORE** setting any of the Cooktop controls.

To Turn ON one or more of the Cooking Zones:

1. Place the correctly sized cookware on the desired Cooking Zone. Be sure to center the cookware on Cooking Zone completely covering the minimum area marked on the Zone surface.

PLEASE NOTE: If the cookware requirements for the Cooking Zone (pan wise) are not met, the sensors will detect a problem and the power level will flash in the display. Any problems must be corrected before proceeding.

2. Touch and hold the **POWER** key pad for 1/2 seconds (or until a beep sounds). The Power LED located above the **POWER** key pad will turn ON. **NOTE:** If no other key pad is touched within 10 seconds the request to Power ON the cooktop will clear.
3. To start one or more of the Cooking Zones, lightly touch the **ON-OFF** key pad for the Cooking Zones needed. A beep will sound and the indicator light located above the **ON-OFF** pad will glow. **NOTE:** If no other key pad is touched within 10 seconds the request to Power ON the Cooktop Zone will clear.
4. Set the desired power level for the Cooking Zone by using either the **hi +** or **- lo** pads. If the "**Power Boost**" maximum power level is needed, once you power up the Cooking Zone, start by touching the **hi +** pad and "**Pb**" will be displayed in the Cooking Zone Display.

NOTE: Once the Cooking Zone power level has been set the food will begin to heat at that level until the power level is manually changed except for Power Boost which will reduce to HI after 10 minutes.



CAUTION

DO NOT TOUCH HOT COOKWARE or PANS directly with hands. Always use oven mitts or pot holders to protect hands from burns.

To Turn OFF the Cooking Zones:

1. Once cooking is complete, touch the **ON-OFF** key pad to turn the Cooking Zone OFF.
2. A beep will sound and the chosen Cooking Zone power level display will turn off. If no other Cooking Zones are active and no other key pads are touched the entire cooktop will shut OFF automatically in 10 more seconds.
3. When any Cooking Zone is OFF, the corresponding Cooking Zone display may display **HE (hot element)** if the Cooking Zone temperature is too HOT. The cooking zone display will continue to display **HE** even if the Cooktop is switched OFF. The cooking zone controls will continue to display **HE** as long as the cooktop remains HOT.



CAUTION

The Cooking Zones may appear to be cool while turned ON and after they have been turned OFF. The glass surface may be HOT from residual heat transferred from the cookware and burns may occur.

IMPORTANT OPERATING NOTES:

- Fluids spilled or objects lying on the controls area of the cooktop may cause the cooktop to display an error code and turn OFF while cooking. Clean the spills or remove the objects from the cooktop.
- Be sure the cooktop vent openings are NOT blocked. If the vent openings are blocked, the cooktop internal sensor may shut OFF the cooktop to avoid overheating the appliance.
- If the cookware or pan is moved from the center of any active Cooking Zone for any reason, a sensor will detect the situation and the cookware will no longer heat. The affected Cooking Zone display will flash indicating a pan is not detected. The Cooking Zone will remember the power level setting for up to 3 minutes before the Cooking Zone will automatically shut OFF.

12 Setting Surface Controls

Operational noises

The electronics generating the induction fields are pretty much noiseless but they do produce heat at high power level. A soft-sounding cooling fan activates when the unit is running multiple cooking zones at once or when a cooking zone is set at very high power settings.

The buzzing sound you could hear from your cooktop is not coming from the electronics but from the cookware you are using. Here are some causes of this noise:

- Most induction-ready cookware are made of several layers of materials. An encapsulated steel layer is usually used to harness the induction field and transform it into heat, which is then transferred to the other materials by radiant energy. The induction field will cause the steel layer to vibrate against the other materials in which it is encapsulated. This is the most common cause of noise from the induction process. This buzzing only happens at the higher power level settings. Note that high quality cookware manufacturers weld this steel layer in place which lowers or cancel this noise.
 - Light weight cookware may also vibrate. We recommend using heavy weight quality cookware.
 - Cookware with warped bottoms can vibrate on the ceramic glass surface at high power settings.
 - **⚠ CAUTION** The power output of your induction cooktop is capable of warping an empty pan. Never use the higher power settings on an empty pan. Even the highest quality cookware is vulnerable to warping.
 - Riveted handles on cookware can also cause buzzing sounds from the vibrations.
 - Solid cast iron and enamelware cookware should not emit any noise. Top quality cookware made of several layers should also be relatively quiet.
-

Ceramic Glass Cooktop Cleaning & Maintenance

Prior to using your cooktop for the first time, apply the recommended CookTop® Cleaning Creme to the ceramic surface. Buff with a **non-abrasive** cloth or **no-scratch** cleaning pad. This will make cleaning easier when soiled from cooking. The special cooktop cleaning cream leaves a protective finish on the glass to help prevent scratches and abrasions.

Consistent and proper cleaning is essential to maintaining your ceramic glass cooktop

Any cookware (cast iron, metal, glass, ceramic, etc) with rough bottoms can mark or scratch the cooktop surface. **Do not slide anything metal or glass across the cooktop. Do not** use your cooktop as a cutting board or work surface in the kitchen. **Do not** cook foods directly on the cooktop surface without a pan. **Do not** drop heavy or hard objects on the glass cooktop, because they may cause it to crack.

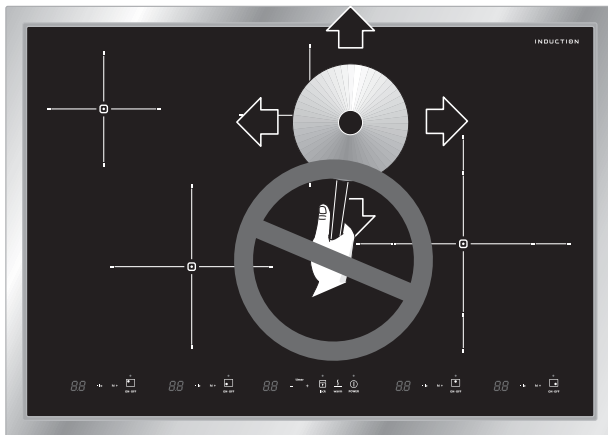

Figure 1

Cleaning recommendations for the ceramic glass cooktop

⚠ CAUTION

Before cleaning the cooktop, be sure the controls are turned to OFF and the cooktop is COOL.

⚠ WARNING

DO NOT use a cooktop cleaner on a hot cooktop. The fumes can be hazardous to your health, and can chemically damage the ceramic-glass surface.

For light to moderate soil:

Apply a few drops of CookTop® Cleaning Creme directly to the cooktop. Use a paper towel or use a **non-abrasive** plastic type **no-scratch** pad to clean the entire cooktop surface. Make sure the cooktop is cleaned thoroughly, leaving no residue.

For heavy, burned on soil:

Apply a few drops of CookTop® Cleaning Creme directly to the soiled area. Rub the soiled area using a **non-abrasive** plastic type **no-scratch** pad, applying pressure as needed. Do not use the pad you use to clean the cooktop for any other purpose.

If soils remain, carefully scrape soils with a metal razor blade scraper, holding scraper at a 30 degree angle to the surface. Remove loosened soils with cooktop cleaning cream and buff surface clean.

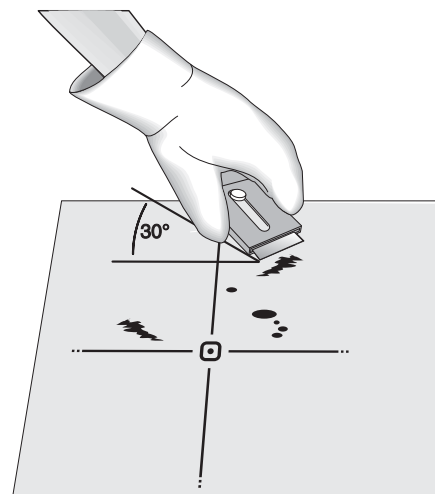

Figure 2

Cleaning recommendations for the ceramic glass cooktop

IMPORTANT NOTE: Damage to the ceramic glass cooktop may occur if you use an abrasive type scratch pad. Only use cleaning products that have been specifically designed for ceramic glass cooktop.

Plastic or foods with a high sugar content:

These types of soils need be removed immediately if spilled or melted onto the ceramic cooktop surface. Permanent damage (such as pitting of the cooktop surface) may occur if not removed **immediately**. After turning the surface elements OFF, use a razor blade scraper or a metal spatula with a mitt and scrape the soil from the hot surface (as illustrated). Allow the cooktop to cool, and use the same method for heavy or burned on soils.

Do not use the following on the ceramic cooktop (See Fig. 2):

- Do not use abrasive cleaners and scouring pads, such as metal and some nylon pads. They may scratch the cooktop, making it more difficult to clean.
- Do not use harsh cleaners, such as chlorine bleach, ammonia or oven cleaners, as they may etch or discolor the cooktop.
- Do not use dirty sponges, cloths or paper towels, as they can leave soil or lint on the cooktop which can burn and cause discoloration.



Fig. 2

Before you call for service, review the following list. It may save you time & expense. The list includes common occurrences that are not the result of defective workmanship or materials in this appliance.

Before you call	
Problem	Solution
Entire cooktop does not operate	<ul style="list-style-type: none"> • Cooktop controls are locked. Set the cooktop controls to unlock the Cooktop (See p. 9 for further instructions). • Make sure household electrical circuit breaker is ON and that power is properly supplied to the Cooktop. • Service wiring not complete. Contact installation agent or dealer. • Power outage. Check house lights to be sure. Call local electric company.
Cooktop turns off while cooking	<ul style="list-style-type: none"> • Cooktop internal heat sensor has detected high temperatures inside the appliance. Be sure the appliance vent holes are not blocked. (Refer to the Installation Instructions supplied with the cooktop for more detailed cooktop installation information). • Fluids spilled or object lying on controls area of cooktop. Clean spills or remove object. Repower cooktop. • Cooking zone had been used with dry pot at a high power level. Wait for the cooking zone to cool down.
Cooking zone does not heat food	<ul style="list-style-type: none"> • No cookware was placed on the Cooking Zone or the cookware material type is incorrect for Induction Cooking. • Cookware bottom not large enough for Cooking Zone. • Cookware is warped or in poor condition. • Cookware is not centered on Cooking Zone. • Cookware resting on cooktop trim or does not rest completely on cooktop surface. • No power to the appliance. Check steps under “Entire cooktop does not operate” in this checklist. • Incorrect Cooking Zone control setting. Make sure the correct control is ON for the Cooking Zone being used. Make sure the cooktop is not locked.
Cooking zone heats food too hot or not hot enough	<ul style="list-style-type: none"> • Lightweight or warped pans were used. Be sure to use good quality cookware. • Use only flat bottom, evenly balanced medium or heavyweight cookware. Heavy and medium weight pans heat evenly. Because lightweight pans heat unevenly, foods may burn more easily (See pages 7-8 for further information). • Adjust Cooking Zone power level setting until the proper amount of heat is obtained.
Poor cooking results	<ul style="list-style-type: none"> • Many factors affect cooking results. Adjust the recipe’s recommended power levels or cooking times. • Cookware is too lightweight or warped. Use heavier quality cookware so foods being prepared may cook more evenly.

Before you call for service, review the following list. It may save you time & expense. The list includes common occurrences that are not the result of defective workmanship or materials in this appliance.

Before you call	
Problem	Solution
Cooktop zone controls display error code	<ul style="list-style-type: none"> If an error occurs that affects a zone, that zone will display an error and that specific zone will shut down. If the error affects more than one zone but a single Induction Heater, then the zones affected by that Induction Heater will display an error and those specific zones will shut down. However if an error occurs that affects the whole cooktop, then the error will display in all zones and the whole cooktop will shut down. If any error occurs try shutting power down to the cooktop then reapply power. If the error persists then call Electrolux 1-877-4ELECTROLUX (1-877-435-3287).
Cooking zones inner LEDs continuously rotating around digital display	<ul style="list-style-type: none"> Induction Cooktop pan detection sensors do not see the correct cookware. Test with a magnet to be sure cookware is made with Induction compatible material. Cookware has been removed from the Cooking Zone without turning the Cooking Zone OFF. Place cookware back on to the Cooking Zone or if finished cooking turn OFF the affected Cooking Zone. Cookware is not centered over the Cooking Zone properly. Refer to page 7-8 for correct cookware placement.
Metal marks on ceramic cooktop glass	<ul style="list-style-type: none"> Sliding or scraping of metal utensils on cooktop surface can cause metal marks. DO NOT slide cookware or cooking utensils across the cooktop surface. Use the recommended ceramic glass cooktop cleaning creme to remove the marks. See "Cooktop Cleaning & Maintenance" in the Care & Cleaning section.
Scratches or abrasions on ceramic cooktop glass	<ul style="list-style-type: none"> Coarse particles such as salt or sand between cooktop and cookware or cooking utensils can cause scratches. Be sure cooktop surface and bottoms of utensils are clean before placing on cooktop. Small scratches do not affect cooking and will become less visible with time. Cleaning materials not recommended for ceramic-glass cooktop have been used. See "Cooktop Cleaning & Maintenance" in the Care & Cleaning section. Cookware with rough bottoms were used. Use smooth, flat-bottomed cookware ONLY.
Brown streaks or specks on ceramic cooktop surface	<ul style="list-style-type: none"> Boil overs are cooked onto cooktop surface. Use a razor blade scraper to remove soil. See "Cooktop Cleaning & Maintenance" in the General Care & Cleaning section.
Area of discoloration with metallic sheen on ceramic cooktop glass	<ul style="list-style-type: none"> Mineral deposits from food and/or water can cause discoloration with metallic sheen. Remove using a ceramic-glass cooktop cleaning creme. Remember to use cookware with clean, dry bottoms. For more information See "Cooktop Cleaning and Maintenance" in the Care & Cleaning section

Your appliance is covered by a one year limited warranty. For one year from your original date of purchase, Electrolux will repair or replace any parts of this appliance that prove to be defective in materials or workmanship when such appliance is installed, used, and maintained in accordance with the provided instructions. In addition, the glass cooktop or radiant surface element of your appliance (excluding built-in and free-standing range appliances) is covered by a two through five year limited warranty. During the 2nd through 5th years from your original date of purchase, Electrolux will provide a replacement glass cooktop or radiant surface element for your appliance which has proven to be defective in materials or workmanship when such appliance is installed, used, and maintained in accordance with the provided instructions.

Exclusions

This warranty does not cover the following:

1. Products with original serial numbers that have been removed, altered or cannot be readily determined.
2. Product that has been transferred from its original owner to another party or removed outside the USA or Canada.
3. Rust on the interior or exterior of the unit.
4. Products purchased "as-is" are not covered by this warranty.
5. Products used in a commercial setting.
6. Service calls which do not involve malfunction or defects in materials or workmanship, or for appliances not in ordinary household use or used other than in accordance with the provided instructions.
7. Service calls to correct the installation of your appliance or to instruct you how to use your appliance.
8. Expenses for making the appliance accessible for servicing, such as removal of trim, cupboards, shelves, etc., which are not a part of the appliance when it is shipped from the factory.
9. Service calls to repair or replace appliance light bulbs, air filters, water filters, other consumables, or knobs, handles, or other cosmetic parts.
10. Labor or in-home service costs during the additional limited warranty periods beyond the first year from your original date of purchase.
11. Pickup and delivery costs; your appliance is designed to be repaired in the home.
12. Surcharges including, but not limited to, any after hour, weekend, or holiday service calls, tolls, ferry trip charges, or mileage expense for service calls to remote areas, including the state of Alaska.
13. Damages to the finish of appliance or home incurred during transportation or installation, including but not limited to floors, cabinets, walls, etc.
14. Damages caused by: services performed by unauthorized service companies; use of parts other than genuine Electrolux parts or parts obtained from persons other than authorized service companies; or external causes such as abuse, misuse, inadequate power supply, accidents, fires, or acts of God.

DISCLAIMER OF IMPLIED WARRANTIES; LIMITATION OF REMEDIES

CUSTOMER'S SOLE AND EXCLUSIVE REMEDY UNDER THIS LIMITED WARRANTY SHALL BE REPAIR OR REPLACEMENT AS PROVIDED HEREIN. **CLAIMS BASED ON IMPLIED WARRANTIES, INCLUDING WARRANTIES OF MERCHANTABILITY OR FITNESS FOR A PARTICULAR PURPOSE, ARE LIMITED TO ONE YEAR OR THE SHORTEST PERIOD ALLOWED BY LAW, BUT NOT LESS THAN ONE YEAR.** ELECTROLUX SHALL NOT BE LIABLE FOR CONSEQUENTIAL OR INCIDENTAL DAMAGES SUCH AS PROPERTY DAMAGE AND INCIDENTAL EXPENSES RESULTING FROM ANY BREACH OF THIS WRITTEN LIMITED WARRANTY OR ANY IMPLIED WARRANTY. SOME STATES AND PROVINCES DO NOT ALLOW THE EXCLUSION OR LIMITATION OF INCIDENTAL OR CONSEQUENTIAL DAMAGES, OR LIMITATIONS ON THE DURATION OF IMPLIED WARRANTIES, SO THESE LIMITATIONS OR EXCLUSIONS MAY NOT APPLY TO YOU. THIS WRITTEN WARRANTY GIVES YOU SPECIFIC LEGAL RIGHTS. YOU MAY ALSO HAVE OTHER RIGHTS THAT VARY FROM STATE TO STATE.

If You Need Service

Keep your receipt, delivery slip, or some other appropriate payment record to establish the warranty period should service be required. If service is performed, it is in your best interest to obtain and keep all receipts. Service under this warranty must be obtained by contacting Electrolux at the addresses or phone numbers below.

This warranty only applies in the USA, Puerto Rico and Canada. In the USA and Puerto Rico, your appliance is warranted by Electrolux Major Appliances North America, a division of Electrolux Home Products, Inc. In Canada, your appliance is warranted by Electrolux Canada Corp. Electrolux authorizes no person to change or add to any obligations under this warranty. Obligations for service and parts under this warranty must be performed by Electrolux or an authorized service company. Product features or specifications as described or illustrated are subject to change without notice.

USA

1.800.944.9044

Electrolux Home Products, Inc.,
10200 David Taylor Drive
Charlotte, NC 28262

Canada

1-800-265-8352

Electrolux Canada Corp.
5855 Terry Fox Way
Mississauga, Ontario, Canada L5V 3E4

www.electrolux-store.com

