

## Use & Care Guide

Wave-Touch™ Front-Load Gas & Electric Dryer

## Guia de Uso y Cuidado

Secadora eléctrica y a gas de carga frontal Wave-Touch<sup>MC</sup>

## Guide d'utilisation et d'entretien

Sécheuse à gaz et à l'électricité à chargement frontal Wave-Touch<sup>MC</sup>

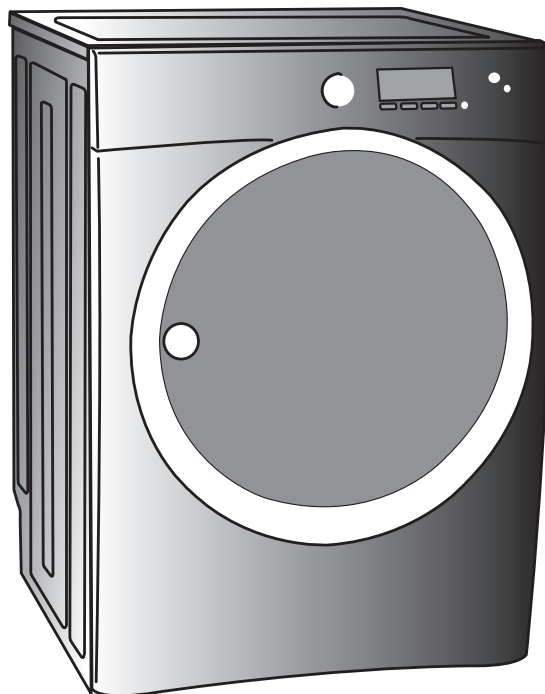

 **Electrolux**

## Please read and save this guide

Thank you for choosing **Electrolux**, the new premium brand in home appliances. This *Use & Care Guide* is part of our commitment to customer satisfaction and product quality throughout the service life of your new appliance.

We view your purchase as the beginning of a relationship. To ensure our ability to continue serving you, please use this page to record important product information.

## Keep a record for quick reference

---

Purchase date

---

Electrolux model number

---

Electrolux serial number

### NOTE

Registering your product with Electrolux enhances our ability to serve you. You can register online at **[www.electroluxappliances.com](http://www.electroluxappliances.com)** or by dropping your Product Registration Card in the mail.

## Questions?

For toll-free telephone support in the U.S. and Canada: **1-877-4ELECTROLUX (1-877-435-3287)**

For online support and product information visit **<http://www.electroluxappliances.com>**

## Table of contents

Finding information.....	2	• User Interface Features .....	22
SAFETY .....	3-5	• Saving Favorites .....	23-24
Features.....	6	• Setting Preferences .....	25-28
Operating Instructions.....	7-29	• Other Features.....	29
• Getting Started .....	7	Cycle Chart (non-steam model) .....	30
• Normal Operating Sounds.....	7	Cycle Chart (steam model).....	31
• Operating Your Dryer .....	8-10	Care & Cleaning.....	32
• Cycle Selection.....	11-16	Solutions to Common Problems .....	33-34
• Drying Temperature .....	17	• Common Drying Problems .....	33
• Dryness Level .....	18	• Service Prevention Checklist.....	34-35
• Drying Time.....	18	Warranty Information.....	36
• Options .....	19-21		

## Important Safety Instructions

### Recognize safety symbols, words and labels

Your safety and the safety of others is very important.

We have provided many important safety messages in the *Use and Care Guide, Installation Instructions* and on your appliance. Always read and obey all safety messages.

Safety items throughout this manual are labeled with a **WARNING** or **CAUTION** based on the risk type as described below:

 **WARNING** This symbol alerts you to situations that may cause serious body harm, death or property damage.

 **CAUTION** This symbol alerts you to situations that may cause bodily injury or property damage.

### NOTE

The instructions appearing in this *Use and Care Guide* are not meant to cover every possible condition and situation that may occur. Common sense and caution must be practiced when installing, operating and maintaining any appliance.

### WARNING

For your safety the following information in this manual must be followed to minimize the risk of fire or explosion or to prevent property damage, personal injury or death.

Do not store or use gasoline or other flammable vapors and liquids in the vicinity of this or any other appliance.

#### WHAT TO DO IF YOU SMELL GAS:

- Do not try to light any appliance.
- Do not touch any electrical switch; do not use any phone in your building.
- Clear the room, building or area of all occupants.
- Immediately call your gas supplier from a neighbor's phone. Follow the gas supplier's instructions.
- If you cannot reach your gas supplier, call the fire department.

Installation and service must be performed by a qualified installer, service agency or the gas supplier.

**Save these instructions for future reference.**

#### 240 v Electric Dryer

10-30R  
3-wire  
(fused 30 amp)

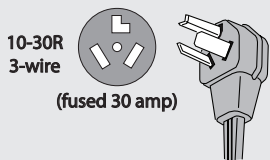

UL-approved service cord must be installed on electric dryers (not provided with unit except those manufactured for sale in Canada).

14-30R  
4-wire  
(fused 30 amp)

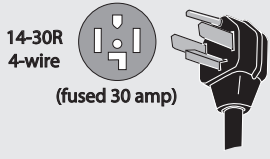

#### 120 v Gas Dryer

Grounding type wall receptacle



Do not, under any circumstances, cut, remove, or bypass the grounding prong.

Power cord with 3-prong grounded plug



Avoid fire hazard or electrical shock. Do not use an adaptor plug or extension cord or remove grounding prong from electrical power cord. Failure to follow this warning can cause serious injury, fire or death.

## **WARNING**

To reduce the risk of fire, electrical shock, or injury to persons when using this dryer, comply with the basic warnings listed below. Failure to comply with these warnings could result in serious personal injuries.

You can be killed or seriously injured if you don't follow these Important Safety Instructions:

### **PREVENT FIRE**

- Do not dry items that have been previously cleaned in, soaked in, or spotted with gasoline, cleaning solvents, kerosene, waxes, etc. Do not store these items on or near the dryer. These substances give off vapors that could ignite or explode.
- Do not place items exposed to cooking oils in your dryer. Items contaminated with cooking oils may contribute to a chemical reaction that could cause a load to catch fire.
- Do not dry articles containing rubber, plastic or similar materials such as bras, galoshes, bath mats, rugs, bibs, baby pants, plastic bags and pillows that may melt or burn. Some rubber materials, when heated, can under certain circumstances produce fire by spontaneous combustion.
- Clean the lint screen before or after each load. The interior of the dryer, lint screen housing and exhaust duct should be cleaned approximately every 18 months by qualified service personnel. An excessive amount of lint build-up in these areas could result in inefficient drying and possible fire. See Care and Cleaning.
- Do not obstruct the flow of ventilating air. Do not stack or place laundry or throw rugs against the front or back of the dryer.
- Do not spray any type of aerosol into, on or near dryer at any time.
- Do not use fabric softeners or products to eliminate static unless recommended by the manufacturer of the fabric softener or product.
- Failure to comply with these warnings could result in fire, explosion, serious bodily injury and/or damage to the rubber or plastic parts of the dryer.

### **PROTECT CHILDREN**

- Do not allow children to play on or in the dryer. Close supervision of children is necessary when the dryer is used near children. As children grow, teach them the proper, safe use of all appliances.
- Destroy the carton, plastic bag and other packing materials after the dryer is unpacked. Children might use them for play. Cartons covered with rugs, bedspreads or plastic sheets can become airtight chambers.
- Keep laundry products out of children's reach. To prevent personal injury, observe all warnings on product labels.
- Before the dryer is removed from service or discarded, remove the dryer door to prevent accidental entrapment.
- Failure to comply with these warnings could result in serious personal injuries.

## **WARNING**

### **FIRE HAZARD**

A clothes dryer produces combustible lint. The dryer must be connected to an outdoors exhaust. Regularly inspect the outdoor exhaust opening and remove any accumulation of lint around the opening and in the surrounding area.

- Do not operate the dryer if the lint screen is blocked, damaged or missing. Fire hazard, overheating and damage to fabrics can occur.

## Important Safety Instructions, con't

### PREVENT INJURY

- To prevent shock hazard and assure stability during operation, the dryer must be installed and electrically grounded by a qualified service person in accordance with local codes. Installation instructions are packed in the dryer for the installer's reference. Refer to **INSTALLATION INSTRUCTIONS** for detailed grounding procedures. If the dryer is moved to a new location, have it checked and reinstalled by a qualified service person.
- To prevent personal injury or damage to the dryer, the electrical power cord of a gas dryer must be plugged into a properly grounded and polarized 3-prong outlet. The third grounding prong must never be removed. Never ground the dryer to a gas pipe. Do not use an extension cord or an adaptor plug.
- ALWAYS disconnect the dryer from the electrical supply before attempting any service or cleaning. Failure to do so can result in electrical shock or injury.
- Do not use any type spray cleanser when cleaning dryer interior. Hazardous fumes or electrical shock could occur.
- To prevent injury, do not reach into the dryer if the drum is moving. Wait until the dryer has stopped completely before reaching into the drum.

### PREVENT INJURY AND DAMAGE TO THE DRYER

- All repairs and servicing must be performed by an authorized servicer unless specifically recommended in this **Use & Care Guide**. Use only authorized factory parts.
- Do not tamper with controls.
- Do not install or store the dryer where it will be exposed to the weather.
- A thermal limiter switch automatically turns off the motor in the unlikely event of an overheated situation (electric dryers only). A service technician must replace the thermal limiter switch after correcting the fault.
- Failure to comply with these warnings could result in serious personal injuries.

# Features

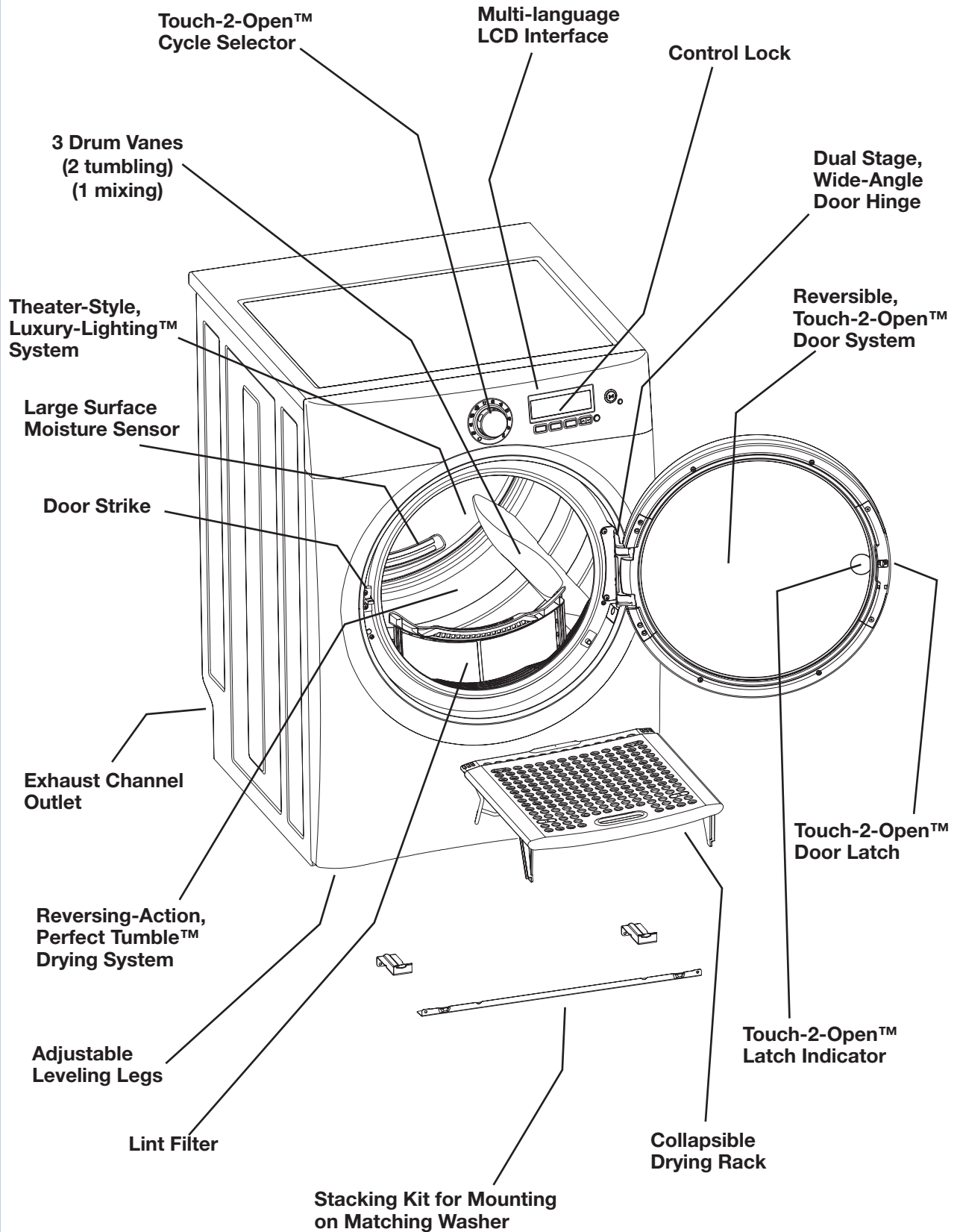

## Getting Started

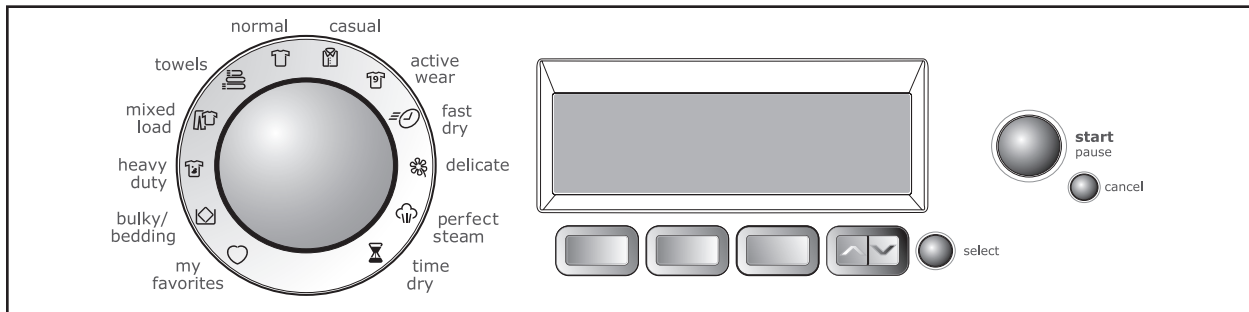

### To operate your dryer, follow these basic steps:

1. Check and clean the lint filter. (See page 8.)
2. Load the dryer. (See page 8.)
3. Select the desired cycle. (See page 9, pages 11-14 and page 29.)
4. Select desired settings and options. (See page 9, page 17, page 18, and pages 19-20.)
5. Start the dryer. (See page 10.)

## Normal Operating Sounds

You may or may not hear the following sounds from your new dryer:

- A. WATER VALVE** (Steam models only.) The flow of water is controlled by electric solenoids. During operation there may be a clicking sound as the valve opens and closes to control the water flow.
- B. SUSPENSION ROLLERS** The dryer drum is supported by a set of suspension rollers. At times there may be a thumping or rolling sound when the dryer starts. This may happen if the dryer has not been in use for a period of time, or after a heavy load has remained in the dryer drum for an extended period, creating a temporary flat spot on the edge of the roller. The noise should dissipate as the dryer operates and the flat spots smooth out.
- C. PERFECT TUMBLE™** When the reversing-action option of **perfect tumble™** is selected, you will hear the intermittent sound of the dryer stopping, momentarily pausing, then restarting in the opposite direction.
- D. AIR FLOW SYSTEM** Your dryer is equipped with a high volume air handling system. In some installations there may be some sounds associated with air movement throughout the dryer, including the air duct, blower, and exhaust system. This is normal and can vary with load size and type.
- E. GAS VALVE** (Gas models only.) The flow of gas is controlled by electric solenoids. During operation

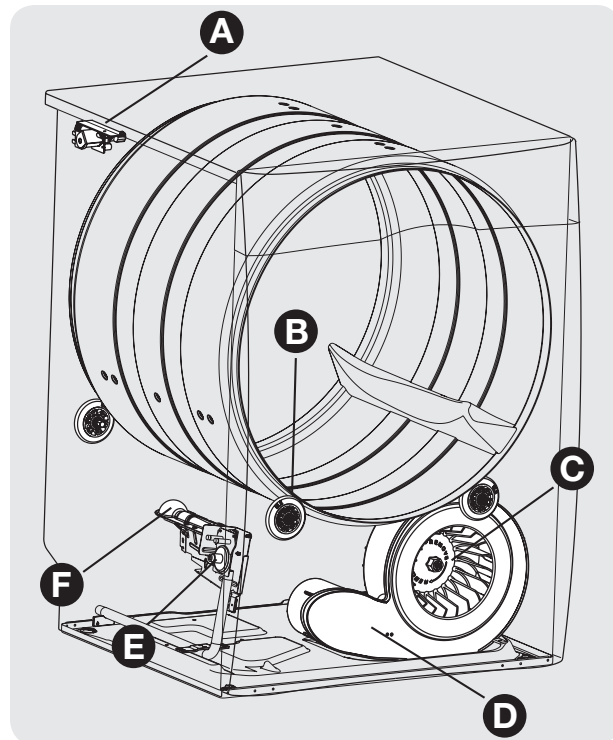

there may be a clicking sound as the valve opens and closes to control the gas flow.

- F. GAS BURNER** (Gas models only.) When the burner is operating, there may be sounds generated as the air flow mixes with the gas flame. This noise is normal and will only occur when the gas is ignited in the combustion tube.

## Operating Your Dryer

### BEFORE USING YOUR DRYER

Read the important instructions in this section of the *Use and Care Guide* before operating your dryer.

#### **WARNING**

To reduce the risk of fire, electric shock or injury to persons, read the IMPORTANT SAFETY INSTRUCTIONS in this *Use and Care Guide* before operating your dryer.

### OPERATING YOUR DRYER

#### 1. Prepare load for drying.

Dry items of similar fabric, weight and construction in the same load.

Separate dark items from light-colored items. Separate items that shed lint from those that attract lint.

Check for stains which may not have been removed in washing. Repeat stain removal process and wash again before drying. Dryer heat may permanently set some stains.

Place delicate or small items in a mesh bag.

Be sure buckles, buttons and trim are heat-proof and won't damage the drum finish. Close zippers; fasten hooks and Velcro®-like fasteners. Tie strings and sashes to prevent snagging and tangling.

#### 2. Check that the lint filter is clean and in place.

A clean lint filter allows the dryer to operate more efficiently.

#### 3. Load the dryer and close the door.

Load items loosely. The average wet load will fill the drum 1/3 to 1/2 full. Items need room to tumble freely for even drying and less wrinkling.

If desired, place a dryer fabric softener sheet on top of the load at the beginning of the cycle.

To save energy and time and avoid uneven drying and wrinkling, do not overload the dryer.

When drying large items, dry only two or three items at a time. Fill out the load with small and medium sized items.

For delicate or very small loads, add two or three similar items to improve tumbling action.

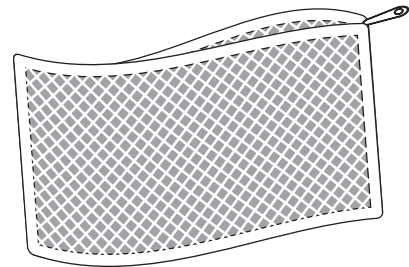

(Mesh bag not included.)

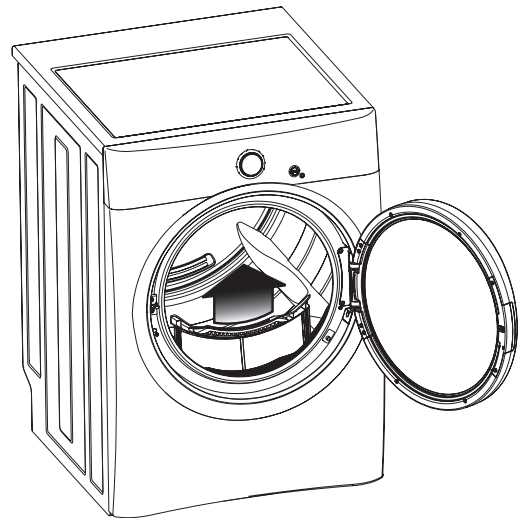



## OPERATING YOUR DRYER, con't

### 4. Select the appropriate cycle and settings for each load.

#### NOTE

Overdrying can cause wrinkles, shrinkage, lint, harshness and a build up of static electricity.

Turn the cycle selector knob in either direction to select the cycle desired. The icon for that cycle will be illuminated and if the cycle description feature is turned on, the cycle and estimated cycle time are displayed on the User Interface screen for 5 seconds. Press any key to advance the User Interface to select settings and options. See the "Cycle Selection" section in this guide for descriptions of each cycle.

If no buttons are pressed, the User Interface screen will automatically advance after 5 seconds and display the preset drying temperature, dryness level (Auto Dry) or drying time (Time Dry), extended tumble time, and options for the cycle selected will be displayed. See the "Cycle Settings Chart" in this guide for settings available for each cycle.

To change the settings, press the **temp**, **dryness level** (Auto Dry) or **drying time** (Time Dry) and **extended tumble** buttons to scroll to the desired settings. Press the scroll up or scroll down buttons under **options** to scroll through the **options** menu. Press the **select** button to add or delete **options**. The estimated cycle time will be displayed at the top of the screens.

#### NOTE

To provide the best care of your laundry, not every setting or option is available with every cycle. If a setting is not available for the cycle selected, it will not be displayed.

Adjustments made to a cycle will be remembered and recalled each time that cycle is selected in the future.

To return to the factory default settings, select **RESET** in **set prefs** under the **options** scroll buttons.

To customize and save up to 3 cycles in non-custom mode plus 9 more cycles for custom users, see **save as favorite** and **CUSTOM MODE** in the User Interface sections of this guide.

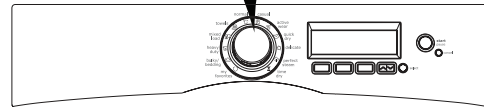
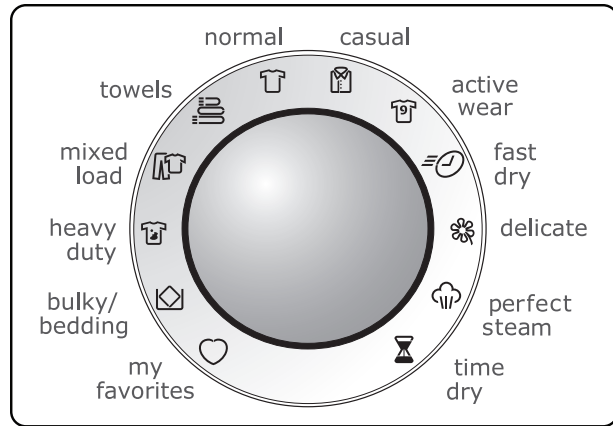

As the Cycle Selector knob is turned, the cycle and estimated cycle time are displayed on the User Interface screen for 5 seconds. Press any key to advance the User Interface and select settings and options.

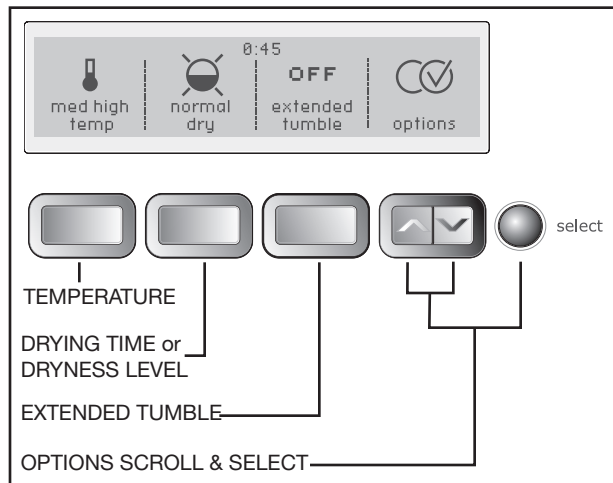

**OPERATING YOUR DRYER, con't****5. Start the cycle.**

Close the door and press **start** to begin the cycle. The dryer will not operate with the door open. To interrupt the cycle, press **pause** or simply open the door. Press **start** again to resume the cycle. Press **cancel** to stop the cycle.

To change the cycle once the cycle has begun, press **cancel**, select a new cycle, and restart the dryer.

To change the **temperature**, **dryness** level or **drying time**, **extended tumble** time or options once the cycle has begun, press **pause**, make the new selections and restart dryer.

A signal will sound at the end of the cycle, periodically during **extended tumble** and **wrinkle release**, when the **damp alert** option is selected and to notify you that the load has finished.

When the cycle ends, **COMPLETE** will be displayed and the drum light will come on. Remove the items promptly and hang or fold.

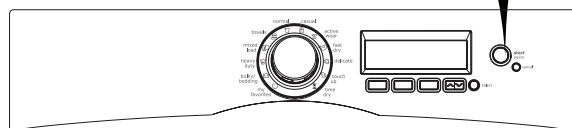
**→ IMPORTANT**

Clean the lint filter after every load. **CLEAN FILTER** will be displayed at the end of the cycle to remind you to remove lint from the filter.

## Cycle Selection

Turn the cycle selector in either direction to the cycle desired. The icon for that cycle will be illuminated. Press on the cycle selector knob to extend it or return it flush to the console.



### For best results

Follow the fabric care label instructions on items to be dried.

To change the cycle once it has begun, press the **cancel** button before selecting a new cycle. Just turning the cycle selector knob to another selection will not change the cycle.

## AUTO DRY CYCLES

Auto Dry cycles take the guesswork out of selecting the correct drying time for each load. Moisture sensing bars at the back of the dryer drum sense the moisture level of the load as it tumbles through the heated air. With Auto Dry cycles, the load will automatically be dried at the selected temperature to the desired dryness level.

Auto Dry cycles save time and energy and protect fabrics. When the load has reached the selected dryness level, it will continue to tumble, unheated, during a cool down period. This helps reduce wrinkling and makes items easier to handle during unloading.

Drying time varies depending on size and dampness of load and fabric type. If the load is too small or almost dry, the moisture sensing bars may not detect enough moisture to continue the cycle and the cycle may end after a few minutes. If this occurs, then select the **time dry** cycle to dry such loads.

Room temperature and humidity, type of installation and electrical voltage or gas pressure can also affect drying time.

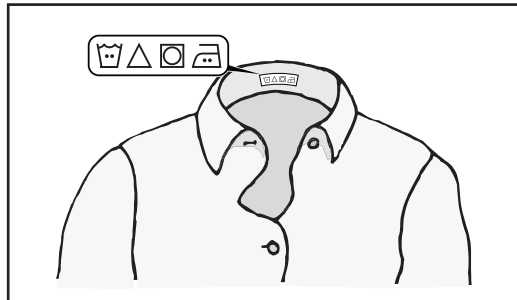
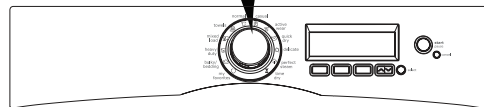
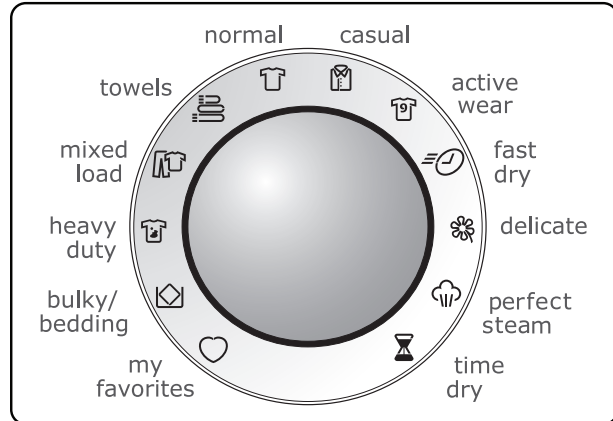

## AUTO DRY CYCLES, con't

### NORMAL

Select this cycle to dry everyday fabrics including cottons and sheets with **high temp, med high temp** or **medium temp** heat. All dryness levels except **maximum dry** and all **options** including **sanitize** are available with this Auto Dry cycle. If equipped with **Perfect Steam™**, the **add steam option** is also available with this cycle.

### TOWELS

Select this cycle to dry heavy loads such as towels and bath mats with **maximum temp, high temp** or **med high temp** heat. The **maximum dry, more dry** and **normal dry** dryness levels and the **perfect tumble** and **sanitize options** are available with this Auto Dry cycle.

### MIXED LOAD

Select this cycle to dry loads containing a mix of fabrics with **med high temp, medium temp,** or **med low temp** heat. All dryness levels except **maximum dry** and all **options** except **sanitize** are available with this Auto Dry cycle. If equipped with **Perfect Steam™**, the **add steam option** is also available with this cycle.

### HEAVY DUTY

Select this cycle to dry durable fabrics such as jeans and overalls with **maximum temp, high temp,** or **med high temp** heat. All dryness levels except **damp dry** and all **options** including **sanitize** are available with this Auto Dry cycle.

### BULKY/BEDDING

Select this cycle to dry bedding and bulky items such as comforters, blankets, sleeping bags and parkas with **med high temp, medium temp,** or **med low temp** heat. **Normal dry** and **less dry** dryness levels and all **options** except **sanitize** are available with this Auto Dry cycle.

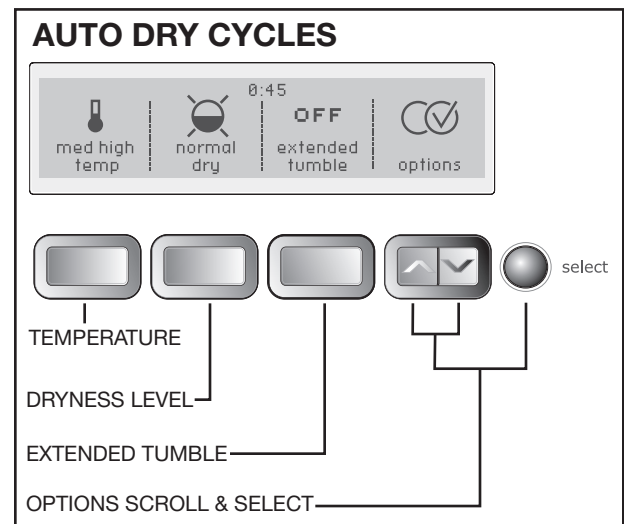
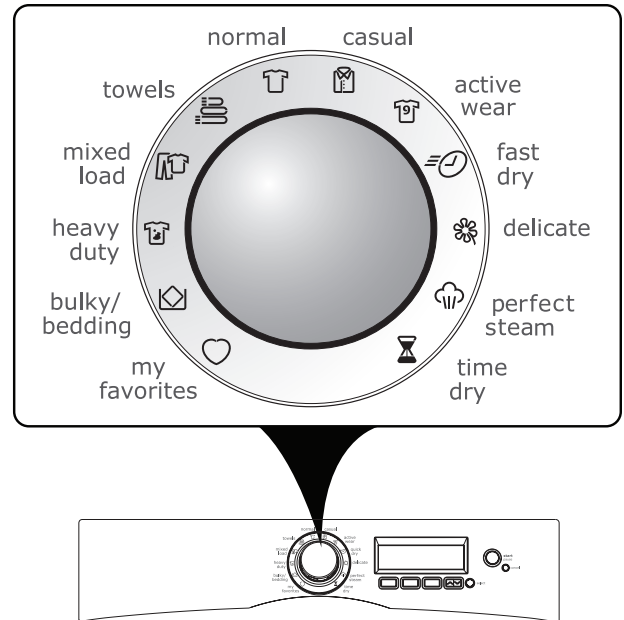

## AUTO DRY CYCLES, con't

### CASUAL

Select this cycle to dry cottons and blends with a no-iron finish using **med high temp**, **medium temp**, or **med low temp** heat. **Normal dry**, **less dry**, and **damp dry** dryness levels and all **options** except **sanitize** are available with this Auto Dry cycle. If equipped with **Perfect Steam™**, the **add steam option** is also available with this cycle.

### ACTIVE WEAR

Select this cycle to dry lightweight synthetic athletic apparel including stretch fabrics with **medium temp**, **med low temp** or **low temp** heat. **Normal dry**, **less dry**, and **damp dry** dryness levels and all **options** except **sanitize** are available with this Auto Dry cycle.

### DELICATE

Select this cycle to dry knits and delicates with **med low temp** or **low temp** heat. **Normal dry**, **less dry**, and **damp dry** dryness levels and all **options** except **sanitize** are available with this Auto Dry cycle.

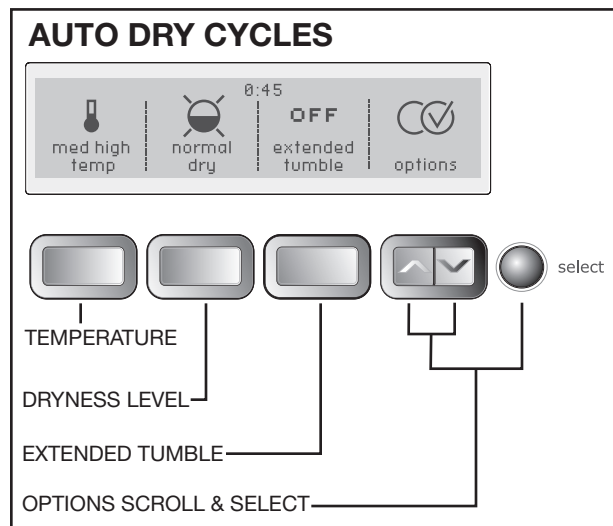
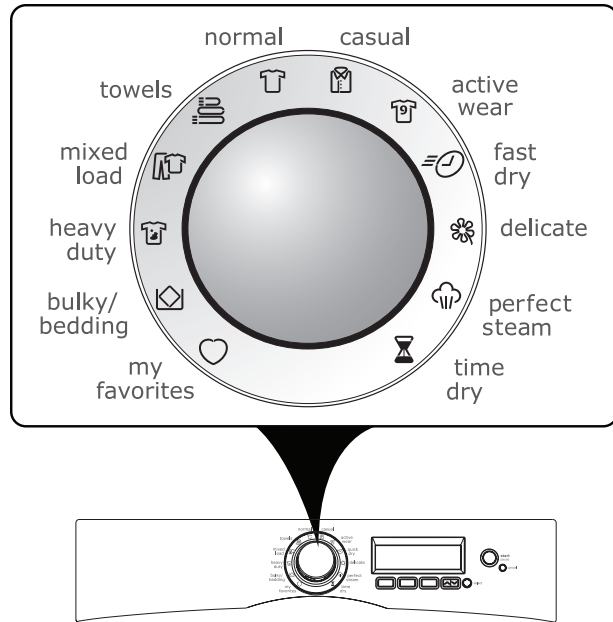

## TIME DRY CYCLES

### TIME DRY

To manually select the drying time for any load, turn the cycle selector knob to **time dry** and press the **drying time** button to select up to 90 minutes of drying time in 15-minute increments. Select any drying temperature. Dryness levels are not selectable with Time Dry cycles. The **extended tumble**, **wrinkle release**, **delicate heat** and **shrink guard** options are available with the **time dry** cycle.

### WARNING

#### FIRE HAZARD

To avoid fire hazard, do not use heat to dry items containing feathers or down, foam rubber, plastics similarly textured, rubber-like materials. Use the time dry cycle and the air (no heat) setting.

### FAST DRY

Select this cycle to quickly dry small loads in 18 minutes with **maximum temp**, **high temp**, or **med high temp** heat. No options are available with this Time Dry cycle.

### PERFECT STEAM

(steam models only)

Select this cycle to refresh fabrics, remove odors and reduce static by injecting the perfect amount of steam into clothing that has been left in the dryer, stored in crowded closets, drawers, or unpacked luggage. The load will tumble for 15 minutes on **low temp** heat while steam is injected into the drum. The **perfect tumble** option is available with this Time Dry cycle.

### NOTE

It is not recommended to use fabric softener sheets with Steam Cycles or Options as it may cause staining on clothes.

### TOUCH UP

(non-steam models only)

Select this cycle to remove wrinkles from clean, dry items that may have been left in the dryer, stored in crowded closets or drawers or unpacked from luggage. The load will tumble for 15 minutes on **low temp** heat. The **perfect tumble** option is available with this Time Dry cycle.

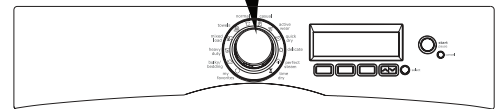
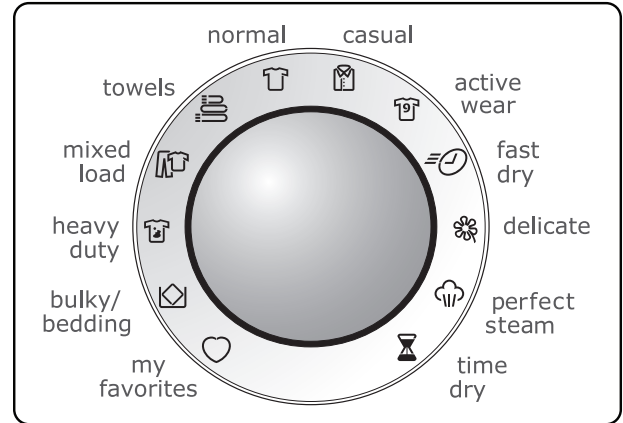

## TIME DRY CYCLES

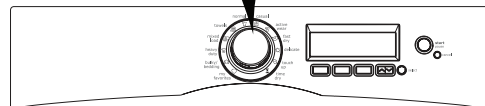
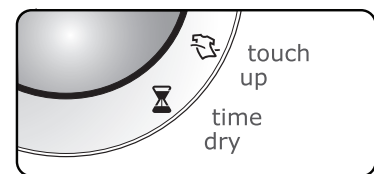
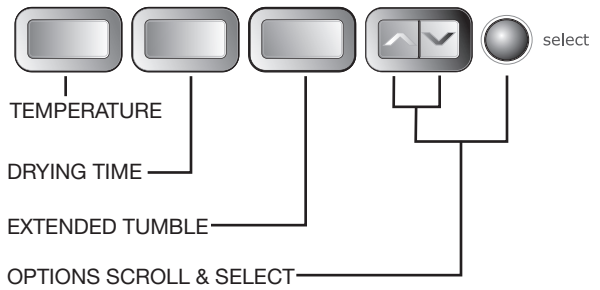
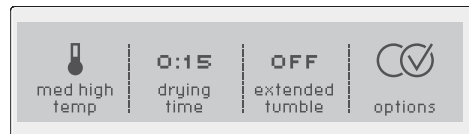

## Cycle Selection, con't

### MY FAVORITES

To select one of your 3 favorite cycles:

- Turn the cycle selector knob to **my favorites**.
- Press the button corresponding to the favorite cycle desired. The custom cycle, settings, and options you saved will automatically be displayed.
- Press the **start** button to begin the cycle.

For example, to select your **my shirts** cycle, turn the cycle selector knob to **my favorites**. Press the button corresponding to **my shirts**, and then press **start**.

(See **save as favorite** in the “Operating User Interface Preferences” section of this guide for instructions on customizing up to 3 cycles.)

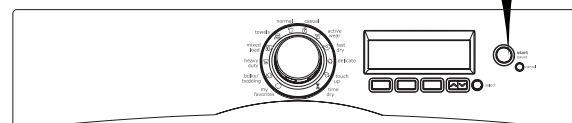
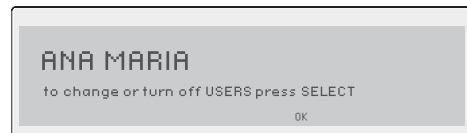
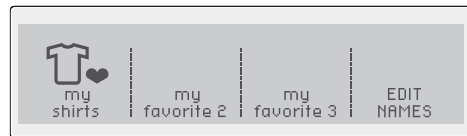
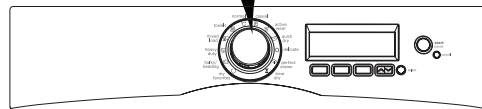
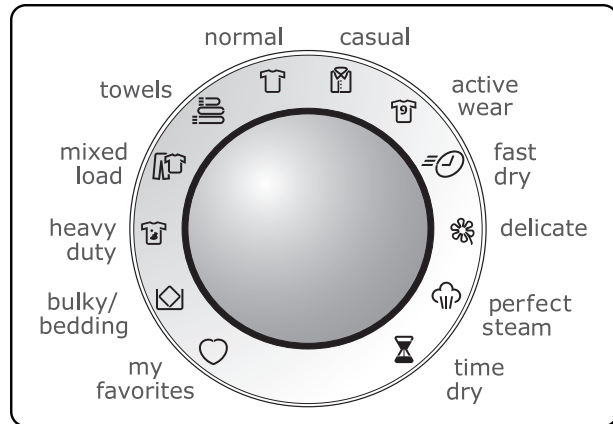

# 16 Operating Instructions

## MY FAVORITES , con't

If more than one user has been entered in **CUSTOM MODE**:

- The current user's name will be displayed when the dryer is turned on if **CUSTOM MODE** is on.
- Press the button under **OK** to continue using that user's favorite cycles.
- The icon for the last cycle run will light up.
- Turn the cycle selector knob to **my favorites**.
- Select one of the 3 customized cycles by pressing the corresponding button.
- Press the **start** button.

To change users:

- Press the **select** button when the dryer turns on and shows the current user's name.
- Press the button under **change users**.
- Select another user's name.
- Press **EXIT**.
- The icon for the last cycle run will light up.
- Turn the cycle selector knob to **my favorites**.
- Select one of the 3 customized cycles by pressing the corresponding button.
- Press the **start** button.

To select a user if a user's name is not displayed when the dryer is turned on:

- Press the **options** buttons to scroll to **set prefs** and then press the **select** button.
- If necessary, press the **options** buttons to scroll to **CUSTOM MODE** and then press the **select** button.
- Press the button corresponding to the user's name.
- The icon for the last cycle run will light up.
- Turn the cycle selector knob to **my favorites**.
- Select one of the 3 customized cycles by pressing the corresponding button.
- Press the **start** button.

(See **CUSTOM MODE** in "Operating User Interface Preferences" in this guide for instructions entering new users and naming favorite cycles.)

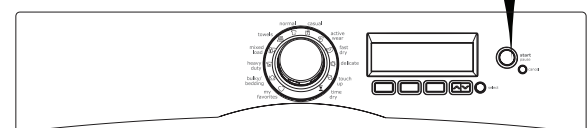
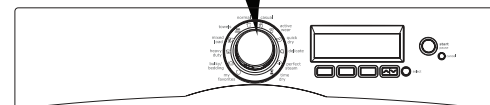
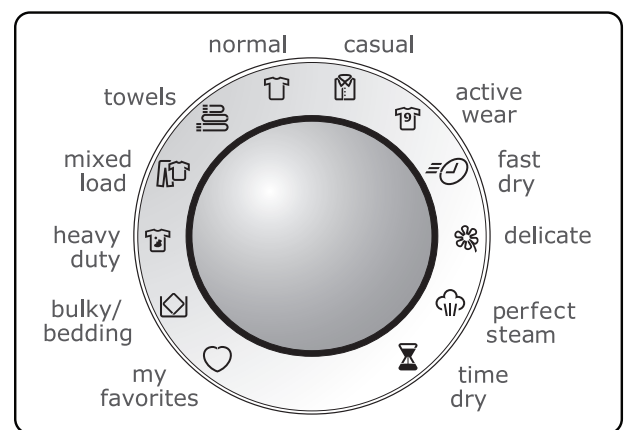
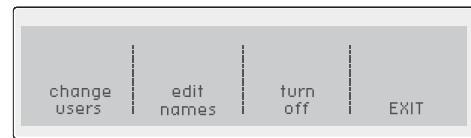



## Drying Temperature

The appropriate drying temperature will automatically be indicated for the cycle selected.



### For best results

Follow the fabric care label instructions on items to be dried.

To change the preset temperature, press the temperature button to scroll to the desired setting.

To protect your fabrics, not all temperatures are available with every cycle. If a temperature is not appropriate for the cycle, it will not be displayed.

The temperature selected for the cycle will be remembered each time that cycle is selected in the future.



### NOTE

To change the temperature once the cycle has begun, press the **pause** button, make the new selection and press **start** again.

#### MAXIMUM TEMP

Recommended to use with the **sanitize** option for towels and heavy duty loads.

#### HIGH TEMP

Recommended for durable fabrics.

#### MED HIGH TEMP

Recommended for most cotton fabrics.

#### MEDIUM TEMP

Recommended for wrinkle free, easy care light-weight fabrics and bulky loads.

#### MED LOW TEMP

Recommended for knits.

#### LOW TEMP

Recommended for delicate fabrics.

#### AIR FLUFF TEMP

This setting (no heat) should only be used with a time dry cycle to dry items containing feathers, down, foam rubber, plastics or rubber-like materials; to refresh clothing, stuffed animals, pillows or blankets; and to dust draperies.

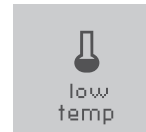
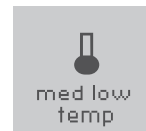

# 18 Operating Instructions

## Dryness Level (Auto Dry)

The appropriate dryness level will automatically be indicated when the cycle is selected.

To change the preset level, press the dryness level button to scroll to the degree of dryness desired.

To protect your fabrics, not all dryness levels are available with every cycle. If a dryness level is not recommended for the cycle, it will not be displayed.

The dryness level selected for the cycle will be remembered and recalled each time that cycle is selected in the future.



### NOTE

To change the dryness level once the cycle has begun, press the **pause** button, make the new selection and press **start** again.

Select the **normal** dryness level for most Auto Dry cycles.

Occasionally a load may seem too damp or over-dried at the end of the cycle. To increase the drying time for similar loads in the future, press the dryness button to select **more dry** or **maximum dry**. For loads requiring less drying time, select **less dry**.

Select **damp dry** for items you wish to partially dry before hanging or ironing.

## Drying Time (Time Dry)

Press the drying time button to select up to 90 minutes of drying time in 15-minute increments. This setting is only available with the **time dry** cycle.

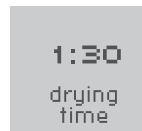
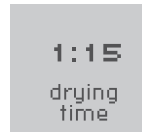
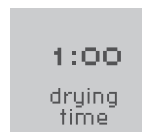
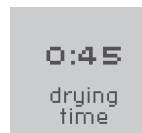
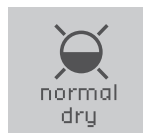
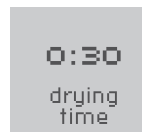
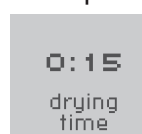
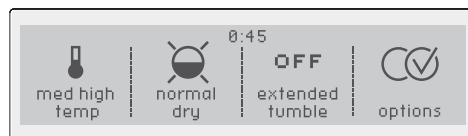

## Options

Suitable options will automatically be indicated when the cycle is selected.

To select or clear the **wrinkle release**, **extended tumble**, **delicate heat**, **perfect tumble**, **sanitize**, **shrink guard** and **damp alert options**, press the **options** buttons until the desired **option** is displayed. Press **select** and **ON** will be displayed in the upper right corner. To clear the **option**, press **select** again and **ON** will disappear.

To protect your fabrics, not all **options** are available with every cycle. If an **option** is not appropriate for the cycle, it will not be displayed.

### NOTE

To change the **options** once the cycle has begun, press the **pause** button, make the new selections and press **start** again.

All **options** selected for the cycle, except **sanitize**, will be remembered each time that cycle is selected in the future. To prevent unintentional and accidental exposure of delicate material to **sanitize** heat, the **sanitize option** will not be remembered and must be reselected each time.

### NOTE

The **sanitize option** will be retained and recalled if it is selected and saved in the **my favorite cycle**.

### ADD STEAM

(steam models only)

The **add steam** option injects steam into the clothing prior to cool down to reduce wrinkling, ironing and static cling.

### NOTE

It is not recommended to use fabric softener sheets with Steam Cycles or Options as it may cause staining on clothes.

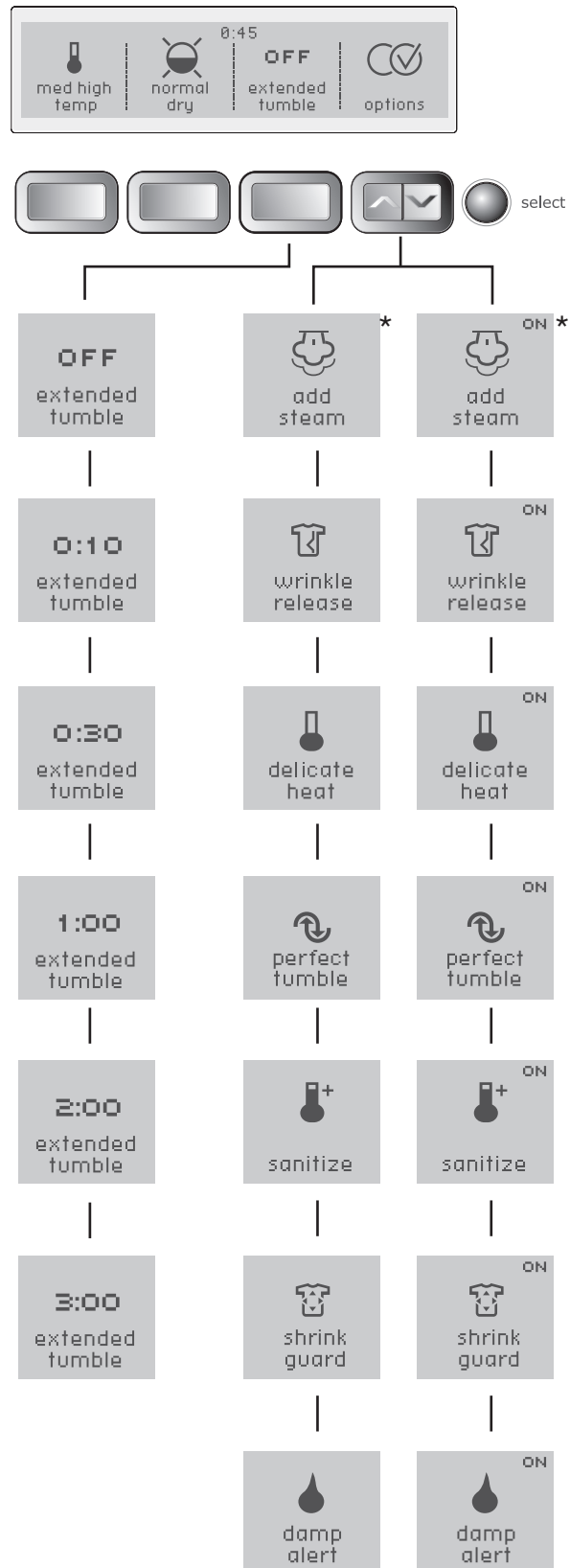

\*Add steam option available on Steam Model only.

## Options, con't

### WRINKLE RELEASE

The **wrinkle release** option helps prevent wrinkles and tangling by alternately tumbling the load without heat for 5 minutes in a clockwise direction, then 5 minutes in a counterclockwise direction, for a total of 45 minutes. A signal will sound every 5 minutes to remind you to remove the load at any time.

The **extended tumble** option can be selected with **wrinkle release** to increase the amount of time the load will tumble without heat. Use this combination if you know it could be up to 3 hours before you can remove the load.

### DELICATE HEAT

Select the **delicate heat** option to protect a load from excessive heat which can lead to shrinking and over-drying. The drying temperature will be gradually reduced as the load dries.

### EXTENDED TUMBLE

Select the **extended tumble** option if the dried load might not be removed promptly at the end of the cycle. The dry load will tumble without heat in a clockwise direction only for the selected time to help reduce wrinkling. Press the **extended tumble** button to select 10 or 30 minutes or 1, 2 or 3 hours tumbling. A signal will sound periodically to remind you to remove the dry load at any time.

The **wrinkle release** option can be selected with **extended tumble** option to increase the amount of time the load will tumble without heat. Use this combination if you know it could be up to 3 hours before you can remove the load.

### PERFECT TUMBLE

The **perfect tumble** option uses reverse tumble action during **cool down** to reduce tangling and wrinkling.

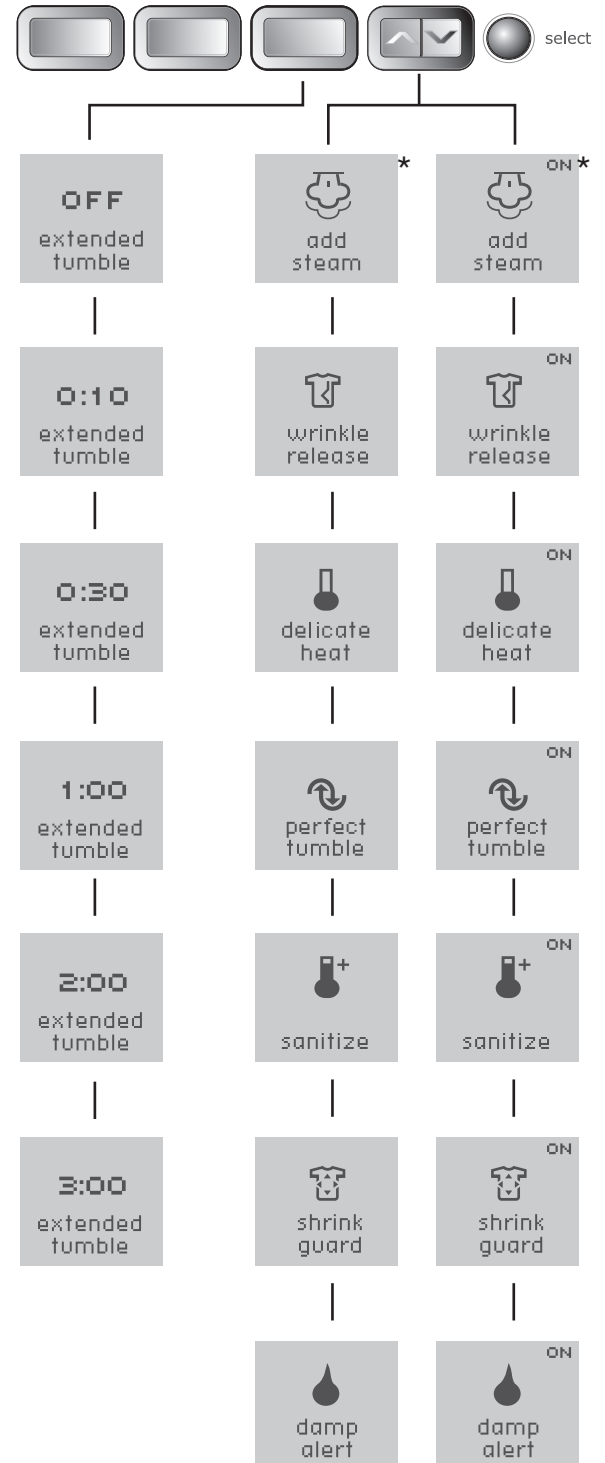
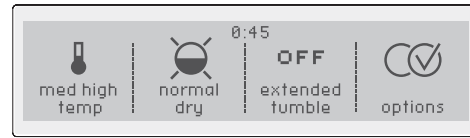

\*Add steam option available on Steam Model only.

## Options, con't

### SANITIZE

Select the **sanitize** option for loads that may contain harmful bacteria. An extended drying time at high heat will kill 99.9% of bacteria with no carry-over of bacteria between loads. Check fabric care labels to prevent damage caused by high heat.



### NOTE

This option has been certified by NSF International®, an independent, third-party testing and certification organization dedicated to public health, safety and environmental protection.



NSF Protocol P154  
Sanitization Performance of  
Residential Clothes Dryers

### SHRINK GUARD

The **shrink guard** option reduces the initial drying temperature and gradually lowers the drying temperature during the cycle to protect fabrics from shrinking.

### DAMP ALERT

For loads that contain some items you plan to hang dry, flat dry or iron, add the **damp alert** option to any Auto Dry cycle. If the **VOLUME** is turned up in your preferences (see “Setting Preferences” on the next page), a chime will sound when the load has reached the **damp dry** dryness level to remind you to remove those items to hang dry, dry flat or iron dry. Open the door, remove those items, close the door and press the **start** button to continue drying the remaining items.

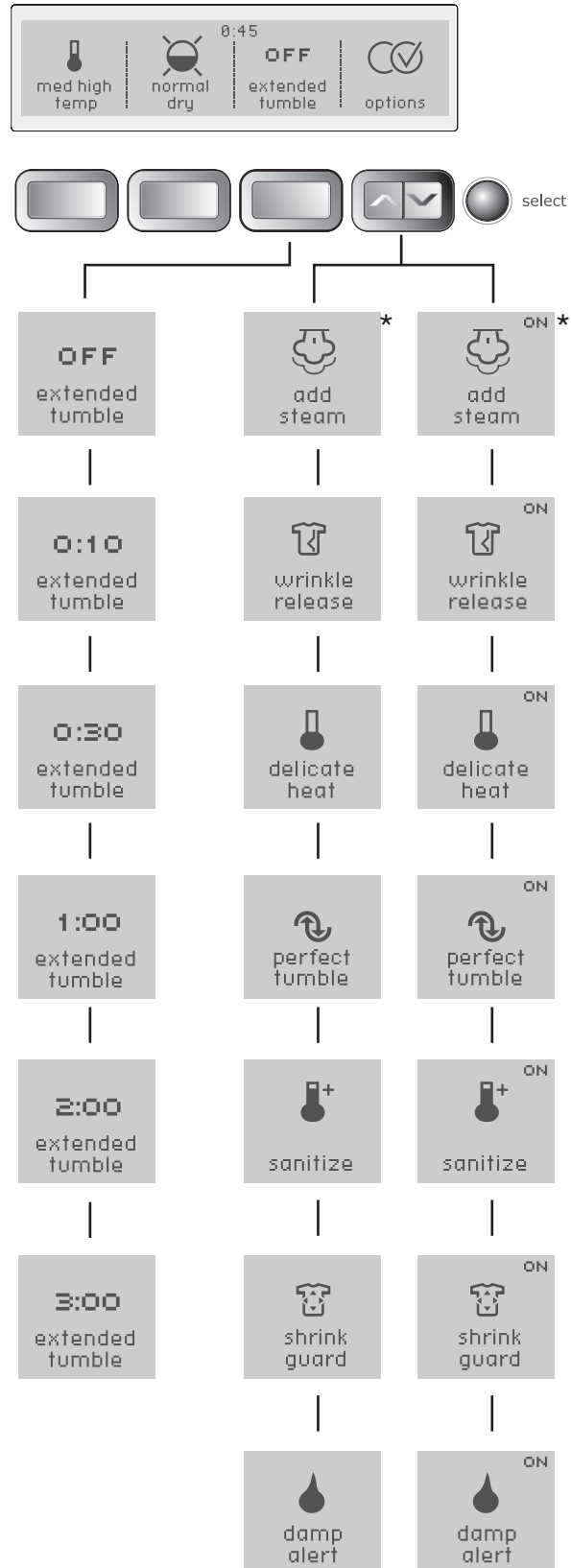

\*Add steam option available on Steam Model only.

## User Interface Features

### SAVE AS FAVORITE

The **save as favorite** feature allows you to personalize up to 3 custom cycles for each saved user. See **save as favorite** in “Operating User Interface Preferences” for more details.

### SET PREFS

The **set prefs** feature allows you to personalize cycles, hide cycle descriptions, select language, volume, brightness and contrast of the display, reset settings and run the installation cycle. See **SET PREFS** in “Operating User Interface Features” for more details.

### USER GUIDES

Scroll through this option for the **CYCLES GUIDE**, **SETTINGS GUIDE**, **OPTIONS GUIDE**, and **SET PREFS GUIDE** for descriptions of the cycles, drying temperatures, dryness levels, cycle options and features for user preferences.

### CONTROL LOCK

To lock the controls between cycles, scroll to the control lock feature press **select** and **CONTROL LOCK OFF - press SELECT to lock the control panel** will be displayed. Press the **select** button to lock the controls. To unlock the controls, press and hold **select** again for 3 seconds. Use this feature to reduce the likelihood of accidental operation by children.

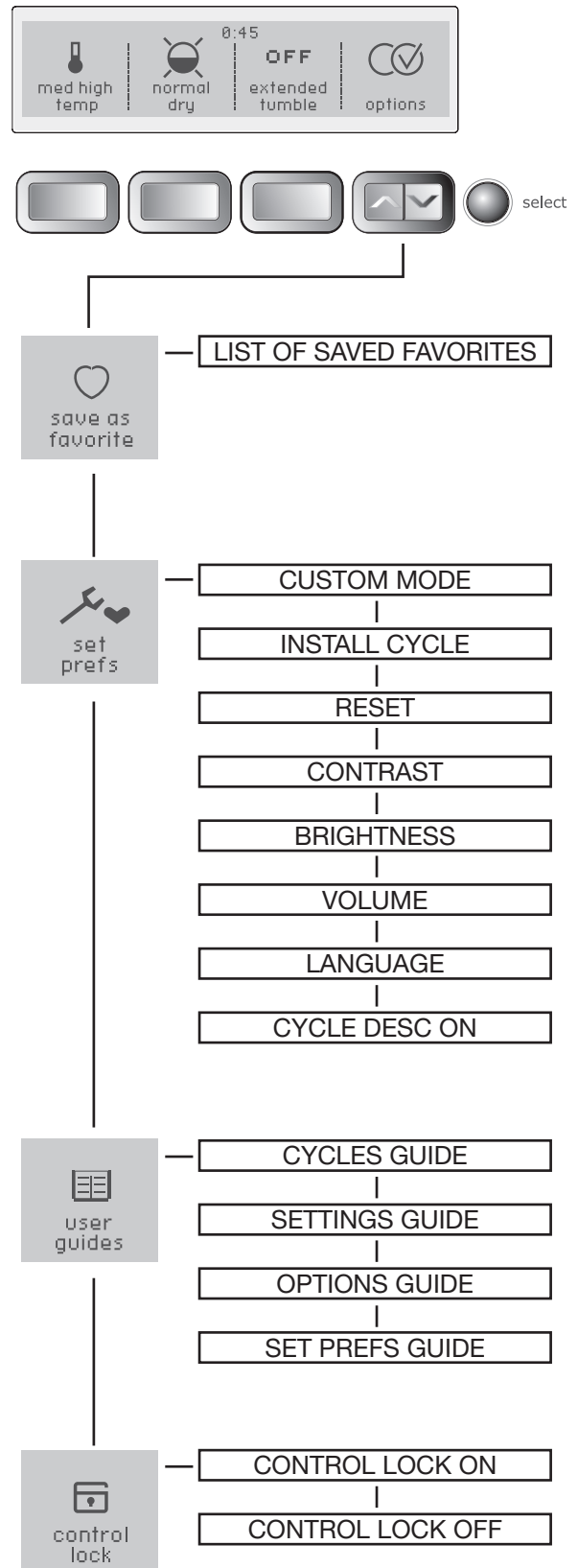

## Saving Favorites

Use the **save as favorite** feature to name and save a custom cycle to memory with all options and settings preferred. Up to 3 favorites may be saved for each custom user. Follow these steps:

- Select a cycle, drying temperature, dryness level (Auto Dry) or drying time (Time Dry), extended tumble time and other options desired.
- Use the scroll up or scroll down button until you reach **save as favorite**.
- Press the **select** button to enter the favorite cycle choice screen.
- Choose 1 of the 3 buttons for naming the cycle.
- See the next page for naming your favorite cycle.

For example, to customize the **normal** cycle for your shirt loads using **med high** drying temperature, **normal dry** dryness level and 10 minutes of **extended tumble**:

- Turn the cycle selector knob to **normal**.
- Press the **temp** button to select **med high temp**.
- Press the **dryness level** button to select **normal dryness**.
- Press the **extended tumble** button to select 10 minutes.
- Press the scroll up or scroll down button until you reach **save as favorite**.
- Press the **select** button to enter the favorite cycle choice screen.
- Press the button under **my favorite 1**.
- See the next page for naming your favorite cycle.

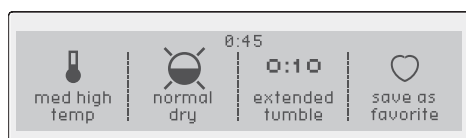
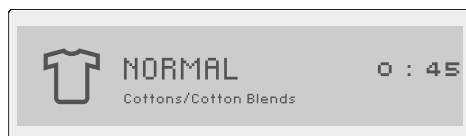

## Saving Favorites, con't

To name the customized cycle for shirts, press **my favorite 1**.

Press the button under **ABC** to name the favorite cycle alphabetically. Use the button under **1A#** to add numbers, foreign language characters or symbols to the name.

Rotate the cycle selector knob in either direction to select the letters **S-H-I-R-T-S**, pausing after each character to let the cursor advance. Press the button under **DELETE** to erase incorrect entries. There is a blank character between **2** and **A** for inserting spaces in your custom name. Pause momentarily on this character as you would to insert any other character, then continue.

Press **select** to save the favorite cycle name.

Repeat the steps to customize 2 other cycles as **my favorite 2** and **my favorite 3**. Any of the favorite cycle names can be changed in the future by turning the cycle selector knob to **my favorites** and pressing the button under **EDIT NAMES**.

See **my favorites** in the “Cycle Selection” section of this guide for instructions on using your customized cycles.

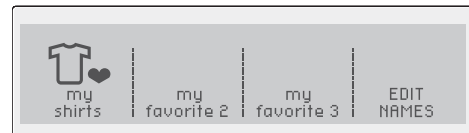
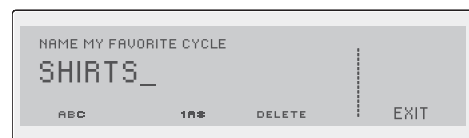
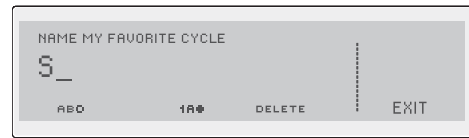



## Setting Preferences

### CUSTOM MODE

**CUSTOM MODE** allows up to 3 household members to personalize up to 3 favorite cycles each.

To enter custom users and personalize favorite cycles:

- Use the scroll up or scroll down buttons until you reach **set prefs**. Press the **select** button to enter the preference menu.
- Press **select** again to enter **CUSTOM MODE**.
- Press the button for **user 1**, **user 2** or **user 3**.
- Press **select**.

Press the button under **ABC** to name the favorite cycle alphabetically. Use the button under **1A#** to add numbers, foreign language characters or symbols to the name.

Rotate the cycle selector knob in either direction to select the characters in the name, pausing after each character to let the cursor advance. Press the button under **DELETE** to erase incorrect entries. There is a blank character between **z** and **A** for inserting spaces in your custom name. Pause momentarily on this character as you would to insert any other character, then continue.

When the name has been entered, press **select** to save the name.

To edit names while in **CUSTOM MODE**, turn the dryer off by pressing **cancel**. Press any other button to wake the dryer up. Screen will display **to change or turn off USERS press SELECT**. You must press **select** within 5 seconds or dryer will return to normal operation with previous user selected. After pressing select you have the choice of **change users**, **edit names**, **turn off** or **EXIT**. Make your selection and follow the directions displayed.

Each custom user may select up to 3 favorite cycles. The dryer will remember cycle settings, options, preferences, etc. for each user. This allows each user to customize without the hassle of selecting all items each time.

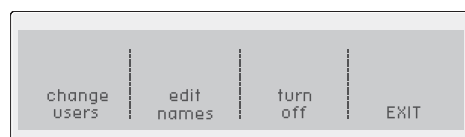
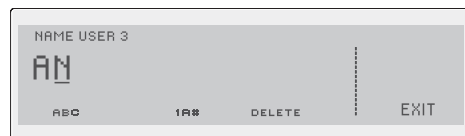
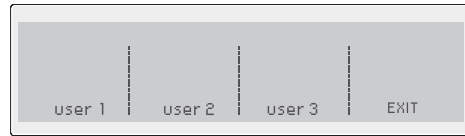

## Setting Preferences, con't

### INSTALL CYCLE

Run the **INSTALL CYCLE** before operating the dryer the first time. Remove all items from the dryer drum and press **start**. For more information on performing the dryer **INSTALL CYCLE**, refer to the *Installation Instructions* accompanying this dryer.

If the dryer has been installed according to *Installation Instructions*, **INSTALL PASS!** will be displayed and the dryer is ready to use.

If the dryer was not installed properly, **SERVICE CORD, NO GAS** or **CALL SERVICE 877 435 3287** will be displayed to indicate the installation error.

The errors may result from the following conditions:

- **SERVICE CORD** (electric dryer)—The power supply cord has been installed improperly or the house wiring to the receptacle is incorrect.
- **NO GAS** (gas dryer)—There is no connection between the dryer and the gas line or the valve is closed.
- **CALL SERVICE**—Error can only be corrected by calling a qualified technician (1-877-435-3287).

Repeat the **INSTALL CYCLE** when corrections are completed.



### NOTE

The **INSTALL CYCLE** is prompted automatically only once when the dryer is turned on the first time at the end of installation. After that, if you wish to run a subsequent **INSTALL CYCLE** when moving the dryer or modifying your installation, you may perform your own **INSTALL CYCLE** by selecting it in the **set prefs** feature and then following the screen prompts.

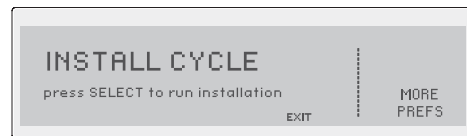

## Setting Preferences, con't

### RESET

Press the buttons indicated to restore only cycle settings, reset only factory preferences (users, language, brightness, volume, etc.) or restore all factory defaults (both cycle settings and factory preferences). Press the button under **EXIT** to return to normal operation or press the **cancel** button to turn the dryer off without making any changes. If you do not make a selection within 30 seconds the dryer will return to normal operation without any changes. If you reset all settings, **INSTALL CYCLE** will be displayed as though the dryer were just turned on for the first time. You may press the button under **CANCEL** if you do not wish to rerun the **INSTALL CYCLE**.

### CONTRAST

Press the button beneath plus (+) or minus (-) symbols to increase or decrease the contrast of the display. Press **select** to accept the change or press the button under **EXIT** to return to normal operation without any changes.

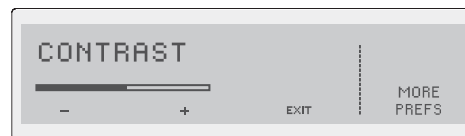
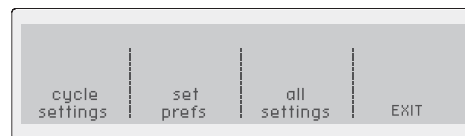
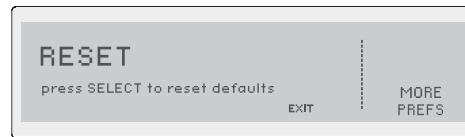

## Setting Preferences, con't

### BRIGHTNESS

Press the button beneath the plus (+) or minus (-) symbols to increase or decrease the brightness of the display. Press **select** to accept the change or press the button under **EXIT** to return to normal operation without any changes.

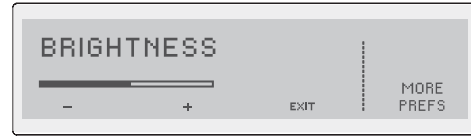

### VOLUME

Press the button beneath the plus (+) or minus (-) symbols to increase or decrease the volume of the chime. Press **select** to accept the change or press the button under **EXIT** to return to normal operation without any changes.

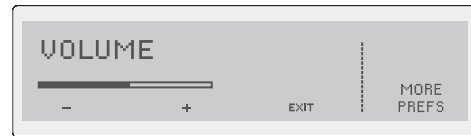

### LANGUAGE

Select English, French or Spanish for the display language.

### CYCLE DESCRIPTION

The name, an icon and a brief description are displayed for each cycle. To delete the display, press **select**. To restore the display, press **select** and **CYCLE DESC ON** - press **SELECT** to turn OFF will appear in the LCD User Interface.

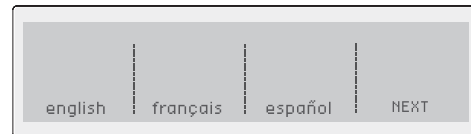

## Other Features

### STATUS DISPLAY

The estimated total cycle time will be displayed when the cycle is selected. The estimated remaining cycle time is displayed during the cycle.



### DRUM LIGHT

The drum light will come on whenever the door is opened to illuminate the drum during loading and unloading. Closing the door turns off the light. The drum light will automatically turn off if the door is left open more than 3 minutes.

To activate the drum light during a cycle, press the button under **LIGHT**. The light will stay on during the cycle for 3 minutes. To turn it off, press the button under **LIGHT** again.



### DRYING RACK

Use the drying rack to dry items which should not be tumble dried. Fold down the metal support on the back of the rack and slowly extend the rack until the lock tabs click into place. Insert the rack into the dryer drum, resting the back support on the moisture sensor bars and the front legs on the air grill.

Place items to be dried on top of the rack, leaving space between items and not allowing them to hang over the sides or through the holes. The weight should not exceed 10 lbs (4.5 kg). Select the **air** (no heat) setting for items containing plastic, foam rubber, rubber-like materials, feathers or down.

When items are dry, remove the rack, push the two center tabs to collapse the rack and fold up the back support. Store the drying rack in a convenient location.

### STATUS DISPLAY

The following will also be displayed at the appropriate times during the cycle:

- DRYING...
- PERFECT STEAM (on Steam Model only)
- DAMP ALERT - DRYING WILL CONTINUE...
- COOLING...
- SANITIZING...
- ADDING STEAM... (on Steam Model only)
- COMPLETE - WRINKLE RELEASE IS ON
- COMPLETE - EXT. TUMBLE WILL CONTINUE
- COMPLETE
- CLEAN FILTER

### REVERSIBLE DOOR

Your dryer is equipped with a reversible door. The door can be hinged on the right or left side.



### NOTE

For step-by-step instructions on DOOR REVERSAL, refer to the *Installation Instructions* supplied with this dryer.

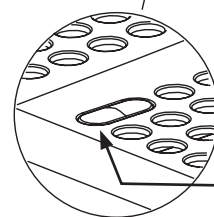
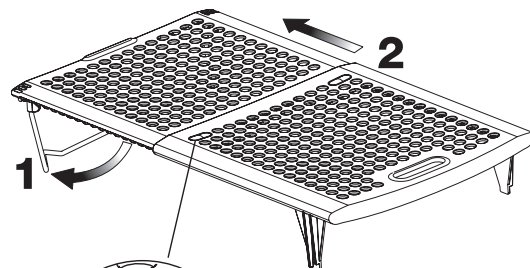

Extend rack until tabs click. Press tabs down to collapse rack.

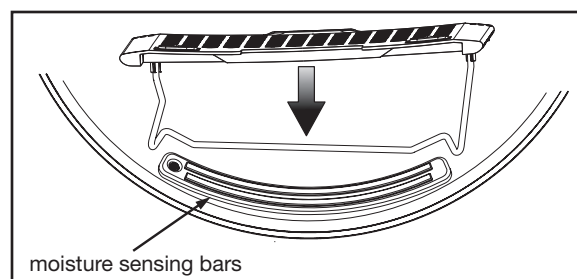

## Dryer Setting Chart (non-Steam Model)

These **Temperature**, **Dryness** levels and **Options** are available with the following cycles:

	bulky/ bedding	heavy duty	mixed load	towels	normal	casual	active wear	fast dry	delicate	touch up	time dry
											
Estimated Cycle Duration**	60 min	70 min	55 min	50 min	45 min	35 min	30 min	18 min	25 min	15 min	15-90 min

### Temperature

maximum temp		✓		✓				✓			✓
high temp		✓*		✓*	✓			✓*			✓
med high temp	✓	✓	✓	✓	✓*	✓		✓			✓*
medium temp	✓*		✓*		✓	✓*	✓				✓
med low temp	✓		✓			✓	✓*		✓		✓
low temp							✓		✓*	✓*	✓
air fluff temp											✓

### Dryness

maximum dry		✓		✓							
more dry		✓	✓	✓*	✓						
normal dry	✓*	✓*	✓*	✓	✓*	✓*	✓		✓		
less dry	✓	✓	✓		✓	✓	✓*		✓*		
damp dry			✓		✓	✓	✓		✓		

### Options

damp alert	✓	✓	✓		✓	✓	✓		✓		
extended tumble	✓	✓	✓		✓	✓*	✓		✓		✓
wrinkle release	✓	✓	✓		✓	✓	✓		✓		
delicate heat	✓	✓	✓		✓	✓*	✓*		✓*		✓
shrink guard	✓	✓*	✓		✓	✓	✓		✓		✓
sanitize		✓		✓	✓						
perfect tumble™	✓	✓	✓	✓	✓	✓*	✓		✓*	✓*	











\* Factory presets

✓ Available selections

\*\*Estimated cycle duration is based on default dryness level and factory settings of electric dryers. Displayed cycle duration may differ slightly on gas models.

## Dryer Setting Chart (Steam Model)

These **Temperature**, **Dryness** levels and **Options** are available with the following cycles:

	bulky/ bedding	heavy duty	mixed load	towels	normal	casual	active wear	fast dry	delicate	perfect steam™	time dry
											
Estimated Cycle Duration**	E 60 min	70 min	55 min	50 min	45 min	35 min	30 min	18 min	25 min	15 min	15-90 min

### Temperature

maximum temp		✓		✓				✓			✓
high temp		✓*		✓*	✓			✓*			✓
med high temp	✓	✓	✓	✓	✓*	✓		✓			✓*
medium temp	✓*		✓*		✓	✓*	✓				✓
med low temp	✓		✓			✓	✓*		✓		✓
low temp							✓		✓*	✓*	✓
air fluff temp											✓

### Dryness

maximum dry		✓		✓							
more dry		✓	✓	✓*	✓						
normal dry	✓*	✓*	✓*	✓	✓*	✓*	✓		✓		
less dry	✓	✓	✓		✓	✓	✓*		✓*		
damp dry			✓		✓	✓	✓		✓		

### Options

damp alert	✓	✓	✓		✓	✓	✓		✓		
extended tumble	✓	✓	✓		✓	✓*	✓		✓		✓
wrinkle release	✓	✓	✓		✓	✓	✓		✓		
delicate heat	✓	✓	✓		✓	✓*	✓*		✓*		✓
shrink guard	✓	✓*	✓		✓	✓	✓		✓		✓
sanitize		✓		✓	✓						
add steam			✓		✓	✓			✓	✓ <sup>1</sup>	
perfect tumble™	✓	✓	✓	✓	✓	✓*	✓		✓*	✓*	

\* Factory presets

✓ Available selections

\*\*Estimated cycle duration is based on default dryness level and factory settings of electric dryers. Displayed cycle duration may differ slightly on gas models.

<sup>1</sup> This option is cannot be deselected.

**⚠ WARNING**

To reduce risk of fire or serious injury to persons or property, comply with the basic warnings listed in the Important Safety Instructions and those listed below.

- Before cleaning the dryer interior, unplug the electrical power cord to avoid electrical shock hazards.
- Do not use any type spray cleanser when cleaning the dryer interior. Hazardous fumes or electrical shock could occur.

**INSIDE**

- Clean the lint filter after every load. Lint build-up on the filter restricts air flow, which causes longer drying times. The filter is located at the bottom of the door opening. Remove by pulling straight up. Remove the lint and replace the filter.
- Occasionally a waxy build-up may form on the lint filter and/or moisture sensing bars from using dryer-added fabric softener sheets. To remove this build-up, wash them with warm, soapy water. Dry the filter thoroughly and replace. Do not operate the dryer without the lint filter in place.
- If the dryer drum becomes stained from noncolorfast fabrics, clean the drum with a damp cloth and a mild liquid household cleanser. Remove cleanser residue before drying the next load.
- Every 18 months an authorized servicer should clean the dryer cabinet interior and exhaust duct. These areas can collect lint and dust over time. An excessive amount of lint build-up could result in inefficient drying and possible fire hazard.

**OUTSIDE**

- Clean the cabinet with mild soap and water. Never use harsh, gritty or abrasive cleansers.
- If the cabinet becomes stained, clean with diluted chlorine bleach (1 part bleach to 8 parts water). Rinse several times with clear water.
- Remove glue residue from tape or labels with a mixture of warm water and mild detergent. Or, touch residue with the sticky side of the tape or label.
- When cleaning chrome parts use a window cleaner with ammonia or mild soap and water.
- Before moving the dryer, place a strip of cardboard or thin fiberboard under the front leveling legs to prevent damage to the floor.

**⚠ WARNING****FIRE HAZARD**

A clothes dryer produces combustible lint. The dryer must be connected to an outdoors exhaust. Regularly inspect the outdoor exhaust opening and remove any accumulation of lint around the opening and in the surrounding area.

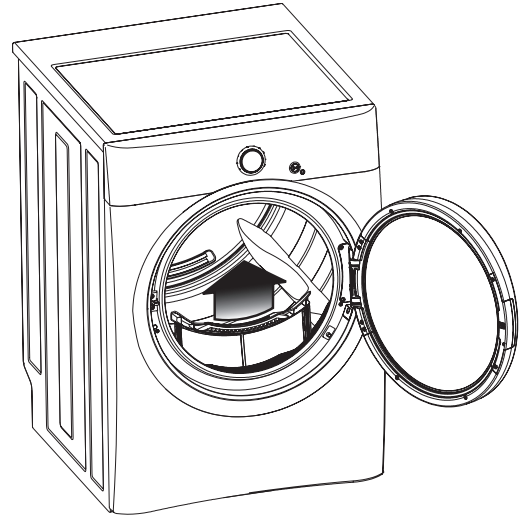
**➔ IMPORTANT**

Clean lint screen after every load.

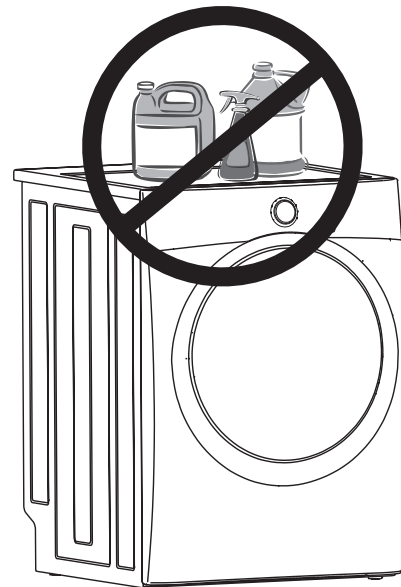
**➔ IMPORTANT**

Do not store or place laundry products on top of dryer at any time. They can damage the finish or controls.



## Common Drying Problems

Many drying problems involve poor cleaning results, poor soil and stain removal, residues of lint and scum, and fabric damage. For satisfactory drying results, follow these suggestions provided by The Soap and Detergent Association.

PROBLEM	POSSIBLE CAUSES	SOLUTIONS	PREVENTIVE MEASURES
Greasy, oily stains	<ul style="list-style-type: none"> <li>Fabric softener sheet.</li> </ul>	<ul style="list-style-type: none"> <li>Rub fabric softener stains with bar soap. Rinse and rewash.</li> </ul>	<ul style="list-style-type: none"> <li>Add a few bath towels to small loads for proper tumbling.</li> <li>Some "silk-like" fabrics should be air dried.</li> <li>Use proper drying temperature.</li> <li>Place fabric softener sheet on top of load before starting the dryer.</li> </ul>
Lint	<ul style="list-style-type: none"> <li>Overloading.</li> <li>Overdrying causes static electricity.</li> <li>Lint screen not clean when cycle began.</li> <li>Lint is attached to "pills."</li> </ul>	<ul style="list-style-type: none"> <li>Reduce load size and rewash using liquid fabric softener in the final rinse.</li> <li>Or, add a fabric softener sheet and tumble without heat.</li> <li>Use lint brush or roller to remove lint.</li> </ul>	<ul style="list-style-type: none"> <li>Do not overload dryer.</li> <li>Use fabric softener in washer or dryer to reduce static electricity.</li> <li>Remove items when they are slightly damp to avoid overdrying.</li> <li>Check that lint filter is clean and in place.</li> </ul>
Pilling (Fibers ball up and cling to fabric.)	<ul style="list-style-type: none"> <li>Overdrying.</li> </ul>	<ul style="list-style-type: none"> <li>Use a lint brush or shaver to remove pills.</li> </ul>	<ul style="list-style-type: none"> <li>Use fabric softener to lubricate fibers.</li> <li>When ironing, use spray starch or fabric finish on collars and cuffs.</li> <li>Turn items inside out to reduce abrasion.</li> </ul>
Shrinking	<ul style="list-style-type: none"> <li>Temperature too high.</li> <li>Overdrying.</li> </ul>	<ul style="list-style-type: none"> <li>Irreversible condition.</li> </ul>	<ul style="list-style-type: none"> <li>Follow fabric care label directions.</li> <li>If shrinking is a concern, check load often.</li> <li>Remove items while slightly damp and hang or lay flat to complete drying.</li> <li>Block knits into shape.</li> </ul>
Wrinkling	<ul style="list-style-type: none"> <li>Overloading.</li> <li>Leaving items in dryer after cycle ends.</li> </ul>	<ul style="list-style-type: none"> <li>Reduce load size and tumble at medium or low heat for 5-10 minutes.</li> <li>Remove items immediately. Hang or fold.</li> </ul>	<ul style="list-style-type: none"> <li>Do not overload dryer.</li> <li>Remove items as soon as cycle ends.</li> </ul>

## Service Prevention Checklist

Before calling for service, review this list. It may save both time and expense. The list includes common occurrences that are not the result of defective workmanship or materials in this dryer.

OCCURRENCE	POSSIBLE CAUSE	SOLUTION
Dryer does not start.	Electrical power cord is not securely plugged in or plug may be loose.	Make sure the plug fits tightly in wall outlet.
	House fuse blown or circuit breaker tripped.	Reset circuit breaker or replace fuse. Make sure electrical line is not overloaded and the dryer is on a separate circuit.
	Thermal limiter tripped.	Call authorized service person for replacement.
LCD displays <i>DEMO MODE</i> .	Dryer has been programmed to temporarily perform a repeating demo cycle.	To return to the factory default settings, select <b>RESET</b> in <b>set prefs</b> under the <b>options</b> scroll buttons.
Dryer runs but won't heat.	There are 2 house fuses in the dryer circuit. If 1 of the 2 fuses is blown, the drum may turn but the heater will not operate. (electric models)	Replace fuse.
	Gas supply valve is not open (gas models).	Check to make sure supply valve is open. See <b>INSTALLATION INSTRUCTIONS</b> for procedure.
	Dryer does not have enough air supply to support the burner flame (gas models).	See <b>INSTALLATION INSTRUCTIONS</b> .
	LP gas supply tank is empty or there has been a utility interruption of natural gas (gas models).	Refill or replace tank. Dryer should heat when utility service is restored.
Drying cycle takes too long, outside of the dryer feels too hot or smells hot.	Lint filter is clogged with lint.	Make sure all lint has been removed from the dryer lint filter before starting each cycle.
	Exhaust duct requirements have not been met.	Exhaust duct must be at least 4 inches in diameter and made of rigid or semi-rigid metal. When in place, the duct must have no more than two 90° bends and must not exceed length listed in <b>INSTALLATION INSTRUCTIONS</b> .
	Electric dryer is connected to a 208 volt circuit.	Drying time will be 20% longer than drying on a 240 volt circuit.
	Drying procedures have not been followed.	See "Operating Instructions."
	Outside exhaust hood or exhaust duct may be clogged or restricted.	Clean out any obstruction.
	High humidity.	Use a dehumidifier near the dryer.

## Service Prevention Checklist, con't

OCCURRENCE	POSSIBLE CAUSE	SOLUTION
Excessive wrinkling.	Dryer is overloaded.	Do not overload. See "Operating Instructions."
	Items left in dryer too long.	Remove items as soon as cycle ends.
	Insufficient sorting of items.	See "Operating Instructions."
	Drying temperature too high.	Follow fabric care label instructions.
Scratching or chipping of the drum finish.	Foreign objects such as coins, pins, clips or buttons are inside the dryer.*	Always remove foreign objects from pockets before laundering. Remove objects from drum and restart dryer.
	Permanently attached items such as belt buckles, zippers and fasteners may be hitting the inside of the drum.*	It may be necessary to sew a scrap of material securely around ornaments before drying to prevent scratching and damage to the dryer.

\*Drum damage caused by foreign objects or permanently attached items is not covered by the warranty.

Your appliance is covered by a one year limited warranty. For one year from your original date of purchase, Electrolux will repair or replace any parts of this appliance that prove to be defective in materials or workmanship when such appliance is installed, used, and maintained in accordance with the provided instructions. In addition, your appliance is covered by an additional one year, parts only, limited warranty. During the 2nd year from your original date of purchase, Electrolux will pay for parts needed for this appliance that have proven to be defective in materials or workmanship when your appliance is installed, used, and maintained in accordance with the provided instructions.

## Exclusions

This warranty does not cover the following:

1. Products with original serial numbers that have been removed, altered or cannot be readily determined.
2. Product that has been transferred from its original owner to another party or removed outside the USA or Canada.
3. Rust on the interior or exterior of the unit.
4. Products purchased "as-is" are not covered by this warranty.
5. Products used in a commercial setting.
6. Service calls which do not involve malfunction or defects in materials or workmanship, or for appliances not in ordinary household use or used other than in accordance with the provided instructions.
7. Service calls to correct the installation of your appliance or to instruct you how to use your appliance.
8. Expenses for making the appliance accessible for servicing, such as removal of trim, cupboards, shelves, etc., which are not a part of the appliance when it is shipped from the factory.
9. Service calls to repair or replace appliance light bulbs, air filters, water filters, other consumables, or knobs, handles, or other cosmetic parts.
10. Pickup and delivery costs; your appliance is designed to be repaired in the home.
11. Surcharges including, but not limited to, any after hour, weekend, or holiday service calls, tolls, ferry trip charges, or mileage expense for service calls to remote areas, including the state of Alaska.
12. Damages to the finish of appliance or home incurred during transportation or installation, including but not limited to floors, cabinets, walls, etc.
13. Damages caused by: services performed by unauthorized service companies; use of parts other than genuine Electrolux parts or parts obtained from persons other than authorized service companies; or external causes such as abuse, misuse, inadequate power supply, accidents, fires, or acts of God.

## DISCLAIMER OF IMPLIED WARRANTIES; LIMITATION OF REMEDIES

CUSTOMER'S SOLE AND EXCLUSIVE REMEDY UNDER THIS LIMITED WARRANTY SHALL BE REPAIR OR REPLACEMENT AS PROVIDED HEREIN. **CLAIMS BASED ON IMPLIED WARRANTIES, INCLUDING WARRANTIES OF MERCHANTABILITY OR FITNESS FOR A PARTICULAR PURPOSE, ARE LIMITED TO ONE YEAR OR THE SHORTEST PERIOD ALLOWED BY LAW, BUT NOT LESS THAN ONE YEAR.** ELECTROLUX SHALL NOT BE LIABLE FOR CONSEQUENTIAL OR INCIDENTAL DAMAGES SUCH AS PROPERTY DAMAGE AND INCIDENTAL EXPENSES RESULTING FROM ANY BREACH OF THIS WRITTEN LIMITED WARRANTY OR ANY IMPLIED WARRANTY. SOME STATES AND PROVINCES DO NOT ALLOW THE EXCLUSION OR LIMITATION OF INCIDENTAL OR CONSEQUENTIAL DAMAGES, OR LIMITATIONS ON THE DURATION OF IMPLIED WARRANTIES, SO THESE LIMITATIONS OR EXCLUSIONS MAY NOT APPLY TO YOU. THIS WRITTEN WARRANTY GIVES YOU SPECIFIC LEGAL RIGHTS. YOU MAY ALSO HAVE OTHER RIGHTS THAT VARY FROM STATE TO STATE.

## If You Need Service

Keep your receipt, delivery slip, or some other appropriate payment record to establish the warranty period should service be required. If service is performed, it is in your best interest to obtain and keep all receipts. Service under this warranty must be obtained by contacting Electrolux at the addresses or phone numbers below.

This warranty only applies in the USA, Puerto Rico and Canada. In the USA and Puerto Rico, your appliance is warranted by Electrolux Major Appliances North America, a division of Electrolux Home Products, Inc. In Canada, your appliance is warranted by Electrolux Canada Corp. Electrolux authorizes no person to change or add to any obligations under this warranty. Obligations for service and parts under this warranty must be performed by Electrolux or an authorized service company. Product features or specifications as described or illustrated are subject to change without notice.

### USA

**1-877-435-3287**

Electrolux Major Appliances North America  
North America  
P.O. Box 212378  
Augusta, GA 30907

### Canada

**1-800-265-8352**

Electrolux Canada Corp.  
5855 Terry Fox Way  
Mississauga, Ontario, Canada  
L5V 3E4