

FRIGIDAIRE

All about the

Use & Care

of your Cooktop



TABLE OF CONTENTS

Welcome & Congratulations	2	Care & Cleaning	10
Important Safety Instructions.....	3	Before You Call	12
Before Setting Surface Controls	6	Major Appliance Warranty	14
Setting Surface Controls	8		

WELCOME & CONGRATULATIONS

Product Registration

Register Your Product

The **PRODUCT REGISTRATION CARD** should be filled in completely, signed and returned to Electrolux Home Products.

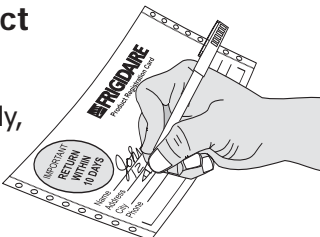

Congratulations on your purchase of a new appliance! At **Electrolux Home Products**, we are very proud of our product and are completely committed to providing you with the best service possible. Your satisfaction is our number one priority.

We know you'll enjoy your new appliance and Thank You for choosing our product. We hope you consider us for future purchases.

PLEASE CAREFULLY READ AND SAVE THESE INSTRUCTIONS

This Use & Care Manual contains general operating instructions for your appliance and feature information for several models. Your product may not have all the described features. The graphics shown are representative. The graphics on your appliance may not look exactly like those shown. These instructions are not meant to cover every possible condition and situation that may occur. Common sense and caution must be practiced when installing, operating and maintaining any appliance.

Serial Plate Location

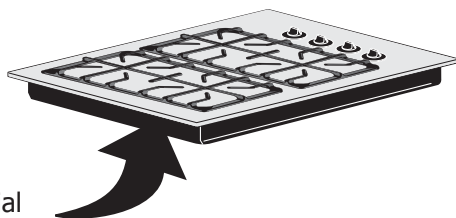

Cooktop Serial Plate Location

Please record your model and serial numbers below for future reference.

Model Number: _____

Serial Number: _____

Purchase Date: _____

NOTE

Please attach sales receipt here for future reference.



IMPORTANT SAFETY INSTRUCTIONS

Read all instructions before using this appliance.
Save these instructions for future reference.

WARNING

If the information in this manual is not followed exactly, a fire or explosion may result causing property damage, personal injury or death.

FOR YOUR SAFETY

- Do not store or use gasoline or other flammable vapors and liquids in the vicinity of this or any other appliance.
- **WHAT TO DO IF YOU SMELL GAS:**
 - Do not try to light any appliance.
 - Do not touch any electrical switch; do not use any phone in your building.
 - Immediately call your gas supplier from a neighbor's phone. Follow the gas supplier's instructions.
 - If you cannot reach your gas supplier, call the fire department.
- Installation and service must be performed by a qualified installer, servicer or the gas supplier.

DEFINITIONS

 This is the safety alert symbol. It is used to alert you to potential personal injury hazards. Obey all safety messages that follow this symbol to avoid possible injury or death.

WARNING

This symbol will help alert you to situations that may cause serious bodily harm, death or property damage.

CAUTION

This symbol will help alert you to situations that may cause bodily injury or property damage.

IMPORTANT

IMPORTANT indicates installation, operation or maintenance information which is important but not hazard-related.

- Remove all tape and packaging wrap before using the cooktop. Destroy the carton and plastic bags after unpacking the cooktop. Never allow children to play with packaging material. Do not remove the model/serial plate attached to the cooktop.
- **Proper Installation**—Be sure your appliance is properly installed and grounded by a qualified technician in accordance with the National Fuel Gas Code ANSI Z223.1 latest edition, or in Canada CAN/CGA B149.1, and CAN/CGA B149.2, and the the National Electrical Code ANSI/NFPA No.70-latest edition, or in Canada CSA Standard C22.1, Canadian Electrical Code, Part 1, and local code requirements. Install only per installation instructions provided in the literature package for this unit.

Ask your dealer to recommend a qualified technician and an authorized repair service. Know how to shut off gas supply at the meter and disconnect the electrical power to the cooktop at the circuit breaker or fuse box in case of an emergency.

- **User Servicing**—Do not repair or replace any part of the appliance unless specifically recommended in the manuals. All other servicing should be done only by a qualified technician. This may reduce the risk of personal injury and damage to the cooktop.
- **Never modify or alter the construction of a cooktop by removing panels, wire covers, or any other part of the product.**
- **Air curtain or other overhead hoods, which operate by blowing a downward air flow on to a range, shall not be used in conjunction with gas ranges other than when the hood and range have been designed, tested and listed by an independent test laboratory for use in combination with each other.**

WARNING

Stepping or leaning on this cooktop can result in serious injuries and may also cause damage to the cooktop. Do not allow children to climb or play around the cooktop.

- **Storage on Appliance**—Flammable materials should not be stored on the cooktop, near surface burners. This includes paper, plastic and cloth items, such as cookbooks, plasticware and towels, as well as flammable liquids. Do not store explosives, such as aerosol cans, on the cooktop. Flammable materials may explode and result in fire or property damage.

IMPORTANT SAFETY INSTRUCTIONS

CAUTION

Do not store items of interest to children in the cabinets above the cooktop.

- **Do not leave children alone—Children should not be left alone or unattended in the area where an appliance is in use.** They should never be allowed to sit or stand on any part of the appliance.
- **DO NOT TOUCH SURFACE BURNERS, GRATES, OR AREAS NEAR THESE BURNERS.** Surface burners may be hot even though the flames are not visible. Areas near surface burners may become hot enough to cause burns. During and after use, do not touch or let clothing or other flammable materials touch these areas until they have had sufficient time to cool. Among these areas are the cooktop and the surfaces facing the cooktop.
- **Wear Proper Apparel—Loose-fitting or hanging garments should never be worn while using the appliance.** Do not let clothing or other flammable materials contact hot surfaces.

WARNING

NEVER use this appliance as a space heater to heat or warm the room. Doing so may result in carbon monoxide poisoning.

- **Do Not Use Water or Flour on Grease Fires—Smother the fire with a pan lid, or use baking soda, a dry chemical or foam-type extinguisher.**
- **When heating fat or grease, watch it closely.** Fat or grease may catch fire if allowed to become too hot.
- **Use Only Dry Pot holders—Moist or damp pot holders on hot surfaces may result in burns from steam.** Do not let the pot holders touch the flame or burners. Do not use a towel or other bulky cloth instead of a pot holder.
- **Do Not Heat Unopened Food Containers—Buildup of pressure may cause container to burst and result in injury.**
- **Know which knob controls each surface burner.** Always turn the knob to the LITE position when igniting the burners. Visually check that the burner has lit. Then adjust the flame so it does not extend beyond the edge of the utensil.

WARNING

Do not use stove top grills on your sealed gas burners. If you use a stove top grill on a sealed gas burner, it will cause incomplete combustion and can result in exposure to carbon monoxide levels above allowable current standards. This can be hazardous to your health.

WARNING

Use proper pan size—This appliance is equipped with one or more surface burners of different sizes. Select utensils having flat bottom large enough to cover the surface burner. The use of undersized utensils will expose a portion of the surface burner to direct contact and may result in ignition of clothing. Proper relationship of utensil to the surface burner will also improve efficiency.

- **Clean the appliance regularly to keep all parts free of grease that could catch fire.** Exhaust fan ventilation hoods and grease filters should be kept clean. Do not allow grease to accumulate on hood or filter. Greasy deposits in the fan could catch fire. When flaming food under the hood, turn fan on. Refer to hood manufacturer's instructions for cleaning.
- **Utensil Handles Should Be Turned Inward and Not Extend Over Adjacent Surface Burners—**To reduce the risk of burns, ignition of flammable materials, and spillage due to unintentional contact with the utensil, the handle of the utensil should be positioned so that it is turned inward, and does not extend over adjacent surface burners.
- **Never Leave Surface Burners Unattended at High Heat Settings—**Boilovers cause smoking and greasy spillovers that may ignite, or a pan that has boiled dry may melt.
- **Protective Liners—**Do not use aluminum foil to line surface burner pans. Protective liners or aluminum foil may interfere with heat and air distribution, and combustion. Damage to the cooktop or personal injury may result.
- **Glazed Cooking Utensils—**Only certain types of glass, glass/ceramic, ceramic, earthenware, or other glazed utensils are suitable for cooktop service without breaking due to the sudden change in temperature. Check the manufacturer's recommendations for cooktop use.
- **Do Not Use Decorative Surface Burner Covers.** If a burner is accidentally turned on, the decorative cover will become hot and possibly melt. You will not be able to see that the burner is on. Burns will occur if the hot covers are touched. Damage may also be done to the cooktop or burners because the covers may cause overheating. Air will be blocked from the burner and cause combustion problems.

IMPORTANT SAFETY NOTICE

The California Safe Drinking Water and Toxic Enforcement Act requires the Governor of California to publish a list of substances known to the state to cause cancer, birth defects or other reproductive harm, and requires businesses to warn customers of potential exposure to such substances.

IMPORTANT SAFETY INSTRUCTIONS

GROUNDING INSTRUCTIONS

For personal safety, the cooktop must be properly grounded. For maximum safety, the power cord must be plugged into an electrical outlet that is correctly polarized and properly grounded.

DO NOT operate the cooktop using a 2-prong adapter or an extension cord. If a 2-prong wall receptacle is the only available outlet, it is the personal responsibility of the consumer to have it replaced with a properly grounded 3-prong wall receptacle installed by a qualified electrician.

See the **INSTALLATION INSTRUCTIONS** packaged with this cooktop for complete installation and grounding instructions.

WARNING

This appliance is equipped with a 3-prong grounding plug for your protection against shock hazard and should be plugged directly into a properly grounded receptacle. **DO NOT** cut or remove the grounding prong from this plug.

Grounding
type wall
receptacle

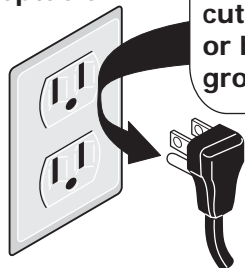

Do not, under any circumstances, cut, remove, or bypass the grounding prong.

Power supply cord with
3-prong grounding plug

WARNING

Avoid fire hazard or electrical shock. **DO NOT** use an adapter plug, an extension cord, or remove grounding prong from electrical power cord. Failure to follow this warning can cause serious injury, fire or death.

CONVERSION TO LIQUEFIED PETROLEUM GAS (OR L.P. GAS)

This natural gas range is designed to allow for conversion to Liquefied Petroleum (L.P.) Gas.

If L.P. conversion is needed, contact the service center for assistance. The L.P. Conversion Kit is provided with this cooktop and is located in the literature envelope. Before installing the kit be sure to follow the L.P. Installation Instructions carefully.

WARNING

Personal injury or death from electrical shock may occur if the range is not installed by a qualified installer or electrician.

CAUTION

Any additions, changes or conversions required in order for this appliance to satisfactorily meet the application needs must be made by an authorized Service Center.

BEFORE SETTING SURFACE CONTROLS

LOCATIONS OF THE GAS SURFACE BURNERS

Your cooktop is equipped with gas surface burners with different BTU ratings. The ability to heat food quicker and in larger volumes increases as the burner size increases.

- The small **SIMMER** burner is best used for simmering delicate sauces, etc. This burner is located at the right rear burner position on the cooktop.
- The **REGULAR** burners can be used for most surface cooking needs. These burners are located at the left rear and left front positions.
- The **POWER** burner is best used when preparing larger quantities of food and it quickly bring liquids up to a rolling boil.
- The large **POWERPLUS** burner is best used for bringing large quantities of liquid rapidly up to temperature or when preparing larger quantities of food.

Regardless of size, always select cookware that is suitable for the amount and type of food being prepared. Select a burner and flame size appropriate to the pan. Never allow flames to extend beyond the outer edge of the pan.

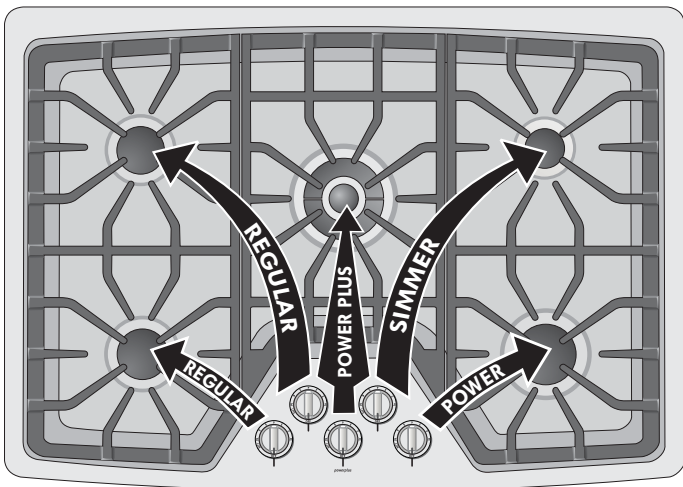

Figure 1

PLACEMENT OF BURNER HEADS AND CAPS

To prevent flare-ups and avoid creation of harmful by-products, **do not** use the cooktop without all burner caps properly installed to insure proper ignition and gas flame size.

It is very important to be sure that all surface burner caps and burner grates are properly installed and in the correct locations **BEFORE** operating the cooktop burners.

Remember:

- Always keep surface burner caps in place whenever using a surface burner.
- When placing the burner caps, be sure that all burner caps **are seated firmly and rest level on top of burner heads.**
- For proper flow of gas and ignition of burners **DO NOT** allow spills, food, cleaning agents or any other material to enter the gas orifice port opening.

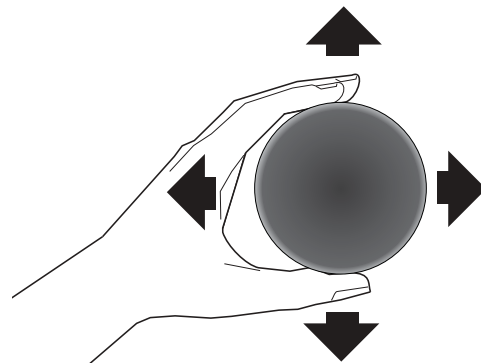

Fig. 2

BEFORE SETTING SURFACE CONTROLS

PLACEMENT OF BURNER HEADS AND CAPS

Round Style Burners

The burner cap lip (See Fig. 1) should fit snug into the center of burner head and rest level. Refer to Figs. 2 & 3 for correct and incorrect burner cap placement. Once in place, you may check the fit by gently sliding the burner cap from side to side (page 6, fig. 2) to be sure it is centered and firmly seated. When the burner cap lip makes contact inside the center of the burner head you will be able to feel it. Please note that the burner cap should NOT move off the center of the burner head when sliding from side to side.

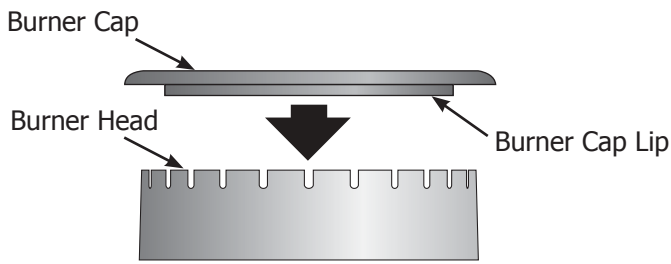
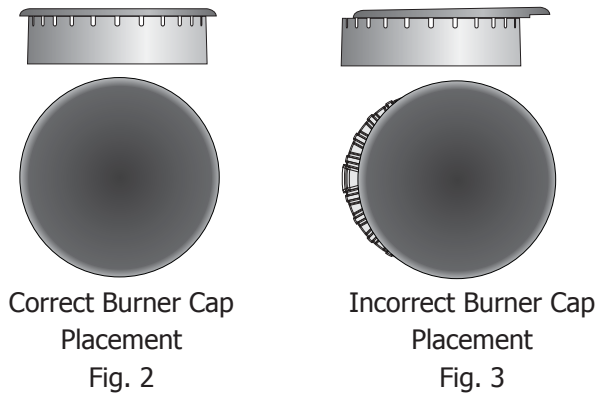

Fig. 1



Double Ring Style Burners

The Double Ring burner only operates properly with two burner caps in place. Be sure the burner cap lips are positioned facing down towards the burner head (Fig. 4) and into the recessed areas (Fig. 5) on each side of the burner head. Be sure both burner caps are seated firmly and rest level on the burner head before operating.

Check the fit for each cap using the same method for the round burner caps by gently sliding each cap from side to side. Please note that the burner cap lips should NOT move out of recessed areas of the burner head.

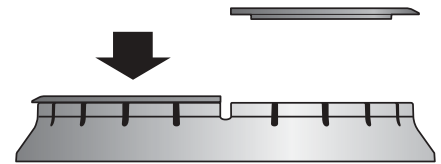

Fig. 4

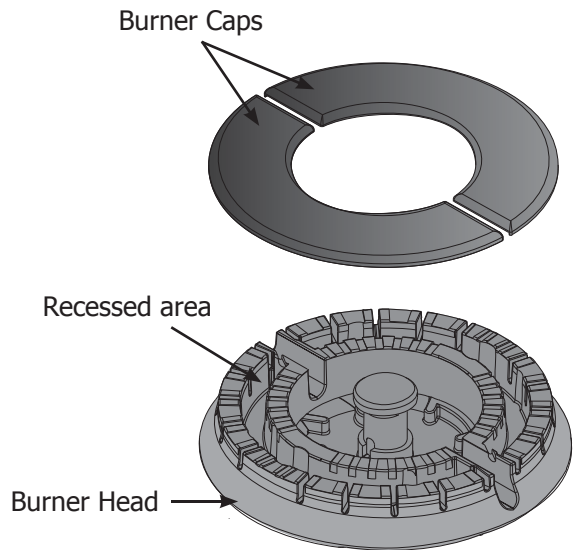

Fig. 5

SETTING SURFACE CONTROLS

SETTING PROPER SURFACE BURNER FLAME SIZE

For most cooking - start on the highest control setting and then turn to a lower one to complete the process. Use the recommendations below as a guide for determining proper flame size for various types of cooking. The size and type of utensil used and the amount of food being cooked will influence the setting needed.

For deep fat frying - use a thermometer and adjust the surface control knob accordingly. If the fat is too cool, the food will absorb the fat and be greasy. If the fat is too hot, the food will brown so quickly that the center will be under cooked. Do not attempt to deep fat fry too much food at once as the food will neither brown nor cook properly.

*Flame Size	Type of Cooking
High Flame	Start most foods; bring water to a boil; pan broiling.
Medium Flame	Maintain a slow boil; thicken sauces, gravies; steaming.
Low Flame	Keep foods cooking; poach; stewing.

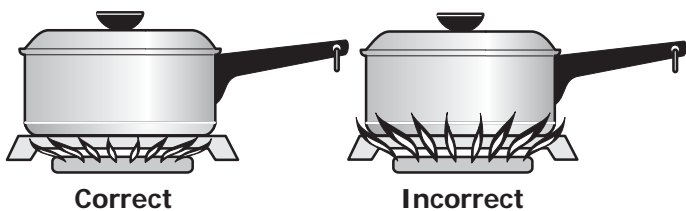

→ IMPORTANT

Never extend the flame beyond the outer edge of the utensil. A higher flame simply wastes heat and energy, and increases the risk of being burned by the gas flame.

📌 NOTE

***Note: Settings are based on using medium-weight metal or aluminum pans. Settings may vary when using other types of pans.** The color of the flame is the key to proper burner adjustment. A good flame is clear, blue and hardly visible in a well-lit room. Each cone of flame should be steady and sharp. Clean burner if flame is yellow-orange.

SETTING THE REGULAR BURNERS

- 1 Place cooking utensil on surface burner.
- 2 Push the surface control knob down and turn **counterclockwise** out of the OFF position.
- 3 Release the knob and rotate to the LITE position (see figure 1). Note: All four electronic surface igniters will spark at the same time. However, only the burner you are turning on will ignite.
- 4 Visually check that the burner has a flame.
- 5 Turn the control knob **counterclockwise** to the desired flame size. The control knobs do not have to be set at a particular setting. Use the knob indicator settings to adjust the flame as needed. **DO NOT** cook with the surface control knob in the LITE position. (The electronic ignitor will continue to spark if the knob is left in the LITE position.)

⚠ CAUTION

Do not place plastic items such as salt and pepper shakers, spoon holders or plastic wrappings on top of the range when it is in use. These items could melt or ignite. Pot holders, towels or wood spoons could catch fire if placed too close to a flame.

⚠ CAUTION

Do not operate the burner for an extended period of time without cookware on the grate. The finish on the grate may chip without cookware to absorb the heat.

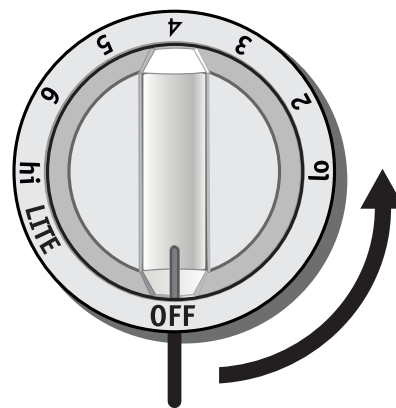

Figure 1

→ IMPORTANT

In the event of an electrical power outage, the surface burners can be lit manually. To light a surface burner, hold a lit match to the burner head, then slowly turn the surface control knob to LITE. After burner lights turn the knob to desired setting. Use caution when lighting surface burners manually.

SETTING SURFACE CONTROLS

SETTING THE DUAL RING BURNER

The Dual Ring Burner has two rings of flame that you can control for two different heat levels, one for small and one for large cookware.

Large Cookware Operation (Figure 1; Zone A & B)

1. Place a large cooking utensil centered over the dual surface Burner Grate.
2. Push the surface control knob down and turn **counterclockwise** out of the OFF position.
3. Release the knob and rotate to the **LITE** position (Figures 2 & 3). Note: All electronic surface igniters will spark at the same time. However, only the selected surface burner will lit.
4. **Visually check that the burner has lit.**
5. When the burner is lit, continue to turn the control knob **counterclockwise** between the "HI" position and the "4" position (figure 3) to adjust to the desired flame size for both burners together. **DO NOT** cook with any of the surface control knobs in the LITE position (The electronic ignitor will continue to spark if the knob is left in the LITE position).

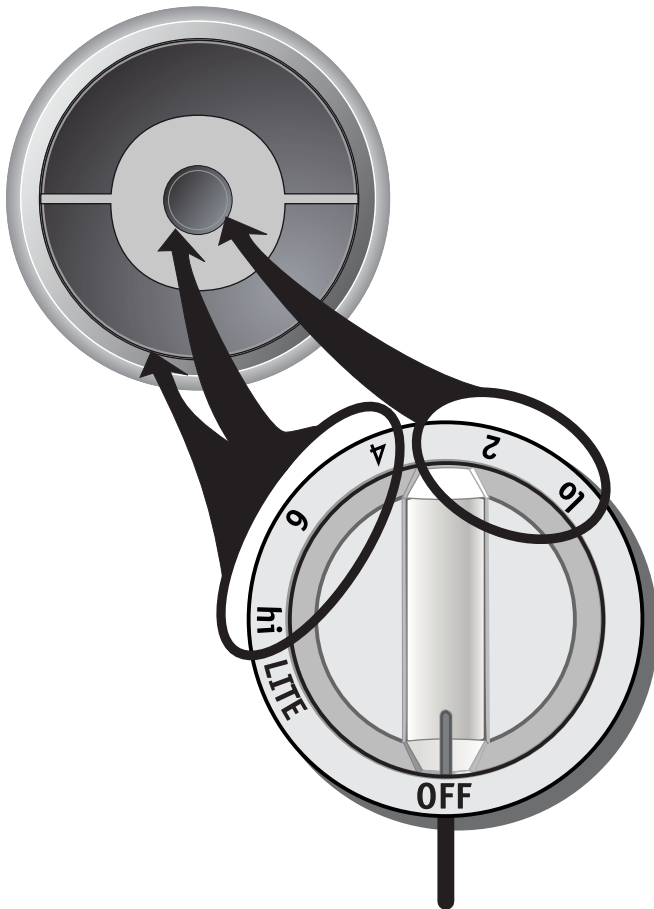

Figure 3

Simmering Operation (Figure 1; Zone A)

1. Place a small cooking utensil centered over the dual surface Burner Grate.
2. Push the surface control knob in and turn **counterclockwise** out of the OFF position (See Figures 2 & 3).
3. Release the knob and rotate to the **LITE** position. Note: All electronic surface igniters will spark at the same time. However, only the Dual Burner will ignite.
4. **Visually check that zone A & B of dual burner has lit.**
5. Continue to turn the gas control knob counterclockwise past the "4" position; zone B will turn off. Adjust the simmer flame size by turning the control knob between the "4" position to the "LO" position (figure 3). **DO NOT** cook with the surface control knob in the LITE position (The electronic ignitor will continue to spark if the knob is left in the LITE position).

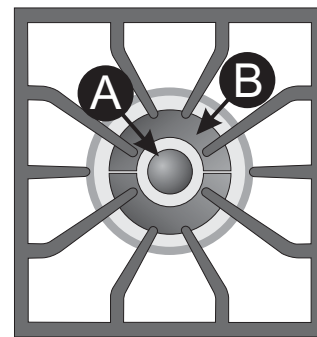

Figure 1

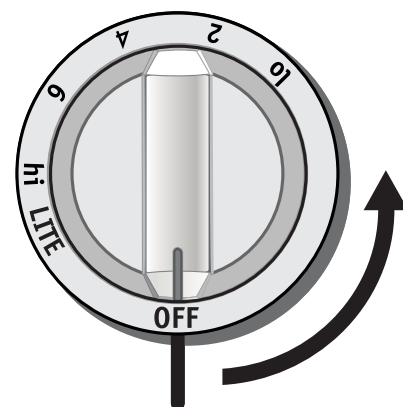

Figure 2

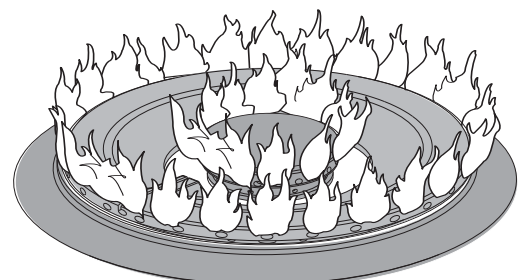

Figure 4

CARE & CLEANING

CLEANING VARIOUS PARTS OF YOUR COOKTOP

Before cleaning any part of the cooktop, be sure all controls are turned OFF and the cooktop is COOL. REMOVE SPILLOVERS AND HEAVY SOILING AS SOON AS POSSIBLE. REGULAR CLEANING WILL REDUCE THE NUMBER OF MAJOR CLEANING LATER.

Cleaning Recommendations	
Surface Type	Cleaning Recommendation
<ul style="list-style-type: none">• Painted and Plastic Control Knobs	For general cleaning, use hot, soapy water and a cloth. For more difficult soils and built-up grease, apply a liquid detergent directly onto the soil. Leave on soil for 30 to 60 minutes. Rinse with a damp cloth and dry. DO NOT use abrasive cleaners on any of these materials; they can scratch.
<ul style="list-style-type: none">• Porcelain Enamel• Burner Grates, Burner Caps	Clean burner grates in the dishwasher and dry upon removal. Gentle scouring with a soapy scouring pad will remove most spots. Rinse with a 1:1 solution of clean water and ammonia. If necessary, cover difficult spots with an ammonia-soaked paper towel for 30 to 40 minutes. Rinse with clean water and a damp cloth, then scrub with a soap-filled scouring pad. Rinse and wipe dry with a clean cloth. Remove all cleaners or the porcelain may become damaged during future heating. DO NOT use spray oven cleaners on the cooktop.
<ul style="list-style-type: none">• Surface Burners• Burner Head	The holes in the burners of your cooktop must be kept clean at all times for proper ignition and a complete, even flame. Clean the burner holes routinely with a small gauge wire or needle and especially after bad spillovers which could clog these holes. To remove, clean and replace sealed burner units; follow the instructions in General Care & Cleaning section under Cleaning the Burner Grates, Burner Caps, Burner Heads. For stubborn stains, scrub with soap and water or a mild abrasive cleanser and damp cloth. Dry the burners thoroughly in a warm oven for 30 minutes. Then replace them, making sure they are seated and level. DO NOT put burner units in the dishwasher.
<ul style="list-style-type: none">• Stainless Steel	Clean stainless steel with hot, soapy water and a dishcloth. Rinse with clean water and a cloth. Do not use cleaners with high concentrations of chlorides or chlorines. Do not use harsh scrubbing cleaners. Only use kitchen cleaners that are especially made for cleaning stainless steel. Always be sure to rinse the cleaners from the surface as bluish stains may occur during heating that cannot be removed.

CLEANING THE BURNER HEADS

Lift the burner cap from the burner head. The surface burner heads are secured to the cooktop and must be cleaned in place.

For proper gas flow it may be necessary to clean the burner heads and slots. To clean, first use a clean DAMP cloth to soak up any spills. Remove any food from between the burner slots using a small nonabrasive brush like a toothbrush and afterwards wipe using a damp cloth. For stubborn soils located in the slots, use a small-gauge wire or needle to clean.

Should you experience ignition problems it may be that an ignition port hole is partially blocked with soil. With the burner head in place, use a small wire gauge needle or the end of a paper clip to clear the ignition port or ports.

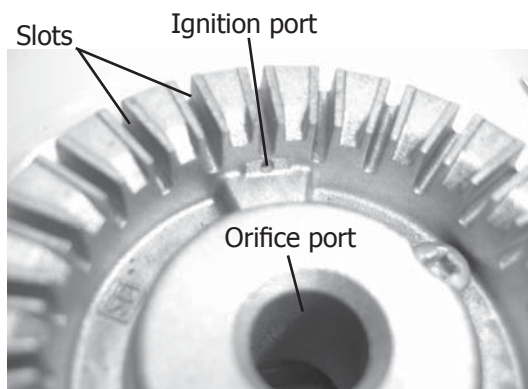

Figure 1- Regular burner head

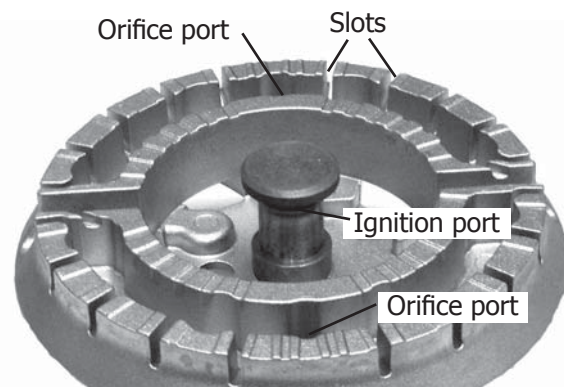

Figure 2- Dual ring burner head

CLEANING THE BURNER CAPS

Should you ever need to remove the burner caps for cleaning lift the burner cap off the burner head. Clean heavy soils with an absorbent cloth. Rinse with a clean, damp cloth and immediately thoroughly dry including the bottom and inside of the cap. Do not use harsh abrasive cleaners. They can scratch the porcelain on the cap. Do not clean burner caps in dishwasher.

When placing the burner caps, see Important note below.

➔ IMPORTANT

When placing the burner caps on the cooktop, be sure the burner caps are seated firmly on top of burner heads. Improper flame size and uneven heating may result when any surface burners are turned ON and the burner caps are not seated correctly.

CLEANING THE BURNER GRATES

The burner grates are dishwasher safe and may be cleaned in the dishwasher. Remove any excessive soils before placing in the dishwasher.

➔ IMPORTANT

- For proper gas flow and ignition of the burners — **DO NOT allow spills, food, cleaning agents or any other material to enter the gas orifice opening.**
- The cooktop is not removable. Do not attempt to remove or lift the cooktop.

⚠ CAUTION

- To avoid possible burns use care when cleaning the cooktop. **DO NOT** attempt to clean the cooktop whenever the cooktop or burner heads are still hot.
- To avoid possible burns **DO NOT** attempt any of the following cleaning instructions provided before turning OFF all of the surface burners and allow them to cool.
- To avoid possible burns **DO NOT** attempt to operate the surface burners without the burner caps.

Your appliance is shipped with the burner heads and burner caps in the correct locations. Before using your gas appliance be sure to:

- Follow installation instructions before operating.
- Remove all packing tape from cooktop area.

BEFORE YOU CALL (Solutions to Common Problems)

IMPORTANT

Before you call for service, review this list. It may save you time and expense. The list includes common occurrences that are not the result of defective workmanship or materials in this appliance.

OCCURRENCE	POSSIBLE CAUSE/SOLUTION
Surface burners do not light.	Surface Control knob has not been completely turned to LITE. Push in and turn the Surface Control knob to LITE until burner ignites and then turn control to desired flame size.
	Be sure gas supply valve is open.
	Burner ports or slots are clogged. With the burner off, use a small-gauge wire or needle to clean ports or slots.
	Power cord is disconnected from outlet (electric ignition models). Be sure cord is plugged securely into outlet.
	Electrical power outage (electric ignition models). Burners can be lit manually. See Setting Surface Controls in this Owner's Guide.
Surface burner flame burns half way around.	Burner ports or slots are clogged. With the burner off, clean ports with a small-gauge wire or needle to clean ports or slots.
	Moisture is present after cleaning. Lightly fan the flame and allow burner to operate until flame is full. Dry the burners thoroughly following instructions under General Cleaning.
Surface burner flame is orange.	Dust particles in main line. Allow the burner to operate a few minutes until flame turns blue.
	In coastal areas, a slightly orange flame is unavoidable due to salt air.

MAJOR APPLIANCE WARRANTY

Your appliance is covered by a one year limited warranty. For one year from your original date of purchase, Electrolux will pay all costs for repairing or replacing any parts of this appliance that prove to be defective in materials or workmanship when such appliance is installed, used and maintained in accordance with the provided instructions.

Exclusions This warranty does not cover the following:

- 1 Products with original serial numbers that have been removed, altered or cannot be readily determined.
- 2 Product that has been transferred from its original owner to another party or removed outside the USA or Canada.
- 3 Rust on the interior or exterior of the unit.
- 4 Products purchased "as-is" are not covered by this warranty.
- 5 Food loss due to any refrigerator or freezer failures.
- 6 Products used in a commercial setting.
- 7 Service calls which do not involve malfunction or defects in materials or workmanship, or for appliances not in ordinary household use or used other than in accordance with the provided instructions.
- 8 Service calls to correct the installation of your appliance or to instruct you how to use your appliance.
- 9 Expenses for making the appliance accessible for servicing, such as removal of trim, cupboards, shelves, etc., which are not a part of the appliance when it is shipped from the factory.
- 10 Service calls to repair or replace appliance light bulbs, air filters, water filters, other consumable, or knobs, handles, or other cosmetic parts.
- 11 Surcharges including, but not limited to, any after hour, weekend, or holiday service calls, tolls, ferry trip charges, or mileage expense for service calls to remote areas, including the state of Alaska.
- 12 Damages to the finish of appliance or home incurred during installation, including but not limited to floors, cabinets, walls, etc.
- 13 Damages caused by: services performed by unauthorized service companies; use of parts other than genuine Electrolux parts or parts obtained from persons other than authorized service companies; or external causes such as abuse, misuse, inadequate power supply, accidents, fires, or acts of God.

DISCLAIMER OF IMPLIED WARRANTIES; LIMITATION OF REMEDIES

Customer's sole and exclusive remedy under this limited warranty shall be product repair or replacement as provided herein. Claims based on implied warranties, including warranties of merchantability or fitness for particular purpose, are limited to one year or the shortest period allowed by law, but not less than one year. Electrolux shall not be liable for consequential or incidental damages such as property damage and incidental expenses resulting from any breach of this written limited warranty or any implied warranty. Some states and provinces do not allow the exclusion or limitation of incidental or consequential damages, or limitations on the duration of implied warranties, so these limitations or exclusions may not apply to you. This written warranty gives you specific legal rights. You may also have other rights that vary from state to state.

If You Need Service Keep your receipt, delivery slip, or some other appropriate payment record to establish the warranty period should service be required. If service is performed, it is in your best interest to obtain and keep all receipts. Service under this warranty must be obtained contacting Electrolux at the addresses or phone numbers below.

This warranty only applies in the USA and Canada. In the USA, your appliance is warranted by Electrolux Major Appliances North America, a division of Electrolux Home Products, Inc. In Canada, your appliance is warranted by Electrolux Canada Corp. Electrolux authorizes no person to change or add to any obligations under this warranty. Obligations for service and parts under this warranty must be performed by Electrolux or an authorized service company. Product features or specifications as described or illustrated are subject to change without notice.

USA
1.800.944.9044
Electrolux Major Appliances
North America
P.O. Box 212378
Augusta, GA 30907



Canada
1.800.265.8352
Electrolux Canada Corp.
5855 Terry Fox Way
Mississauga, Ontario, Canada
L5V 3E4