

FRIGIDAIRE

All about the

Use & Care

of your Wall Oven



TABLE OF CONTENTS

| | | | |
|---|---|-----------------------------|----|
| Product Record and Registration | 2 | Care and Cleaning | 17 |
| Important Safety Instructions | 3 | Before You Call | 20 |
| Before Setting Oven Controls | 7 | Warranty | 21 |
| Oven Controls | 8 | | |

PRODUCT RECORD AND REGISTRATION

| | |
|--|-----------|
| Need Help? | 2 |
| Product Registration | 2 |
| Product Record and Registration | 2 |
| Important Safety Instructions | 3 |
| Before Setting Oven Controls | 7 |
| Oven Controls | 8 |
| Care and Cleaning | 17 |
| Before You Call | 20 |
| Warranty | 21 |

Need Help?

Visit the Frigidaire web site at www.frigidaire.com

Before you call for service, there are a few things you can do to help us serve you better.

Read this Use & Care Manual

This manual contains instructions to help you use and maintain your oven properly.

If You Received a Damaged Oven...

Immediately contact the dealer (or builder) that sold you the oven.

Save Time and Money

Check "[Solutions to Common Problems](#)" on page 20. This section helps step you through some common problems that might occur.

If you do need service, help is only a phone call away. Call Frigidaire customer services at **1-800-944-9044**.

Product Registration

Registering your product with Frigidaire enhances our ability to serve you. You can register online at <http://www.frigidaire.com> or by dropping your product registration card in the mail.

Record model & serial numbers here

Purchase Date: _____

Frigidaire model number: _____

Frigidaire serial number: _____

Serial Plate Location

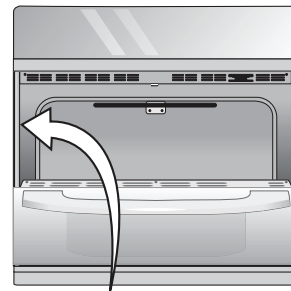

Questions?

For toll-free telephone support in the U.S. and Canada call **1-800-944-9044**

For online support and Internet production information visit <http://www.frigidaire.com>.

Thank you for choosing Frigidaire.

This Use & Care manual is part of our commitment to customer satisfaction and product quality throughout the service life of your new appliance. We view your purchase as the beginning of a relationship. To ensure our ability to continue serving you, please use this page to record important product information.

IMPORTANT SAFETY INSTRUCTIONS

CAUTIONS & WARNINGS

Read all instructions before using this appliance.

This manual contains important safety symbols and instructions. Please pay attention to these symbols and follow all instructions given.

Do not attempt to install or operate your appliance until you have read the safety precautions in this manual. Safety items throughout this manual are labeled with a WARNING or CAUTION statement based on the risk type.

DEFINITIONS

 This is the safety alert symbol. It is used to alert you to potential personal injury hazards. Obey all safety messages that follow this symbol to avoid possible injury or death.

WARNING

Indicates a potentially hazardous situation which, if not avoided, may result in death or serious injury.

CAUTION

Indicates a potentially hazardous situation which, if not avoided, may result in minor or moderate injury.

IMPORTANT

Indicates installation, operation, maintenance, or valuable information that is not hazard related.

NOTE

Indicates a short, informal reference—something written down to assist the memory or for future reference.

WARNING

Storage In or On Appliance—Flammable materials should not be stored in an oven or near surface units. This includes paper, plastic, and cloth items, such as cookbooks, plastic ware, and towels, as well as flammable liquids. Do not store explosives, such as aerosol cans, on or near the oven.

WARNING



Tip Over Hazard

- **A child or adult can tip the oven and be killed.**
- **Install the anti-tip device to oven and/or structure per installation instructions.**
- **Ensure the anti-tip device is re-engaged when the oven is moved.**
- **Do not operate the oven without the anti-tip device in place and engaged.**
- **Failure to follow these instructions can result in death or serious burns to children and adults.**

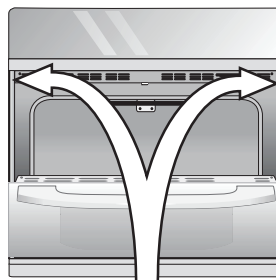

Refer to the installation instructions supplied with your appliance for proper installation.

Anti-tip mounting holes

Check for proper installation with a visual check that the anti-tip screws are present. Test the installation with light downward pressure on the open oven door. The oven should not tip forward.

IMPORTANT SAFETY INSTRUCTIONS

WARNING

- Do Not Leave Children Alone - Children should not be left alone or unattended in the area where appliance is in use. They should never be allowed to sit or stand on any part of the appliance, including the storage drawer, lower broiler drawer, warmer drawer, or lower double oven.
- Stepping, leaning, or sitting on the door or drawers of an oven can result in serious injuries and also cause damage to the appliance. Do not allow children to climb or play around the oven. The weight of a child on an open oven door may cause the oven to tip, resulting in serious burns or other injury.
- Never cover any slots, holes, or passages in the oven bottom or cover an entire oven rack with materials, such as aluminum foil. Aluminum foil linings may trap heat, causing a fire hazard.

IMPORTANT

- Important Safety Notice - The California Safe Drinking Water and Toxic Enforcement Act requires the governor of California to publish a list of substances known to cause cancer, birth defects, or other reproductive harms, and it requires businesses to warn customers of potential exposures to such substances.
- Do not attempt to operate the oven during a power failure. If the power fails, always turn off the oven. If the oven is not turned off and the power resumes, the oven will begin to operate again. Once the power resumes, reset the clock and oven function.
- Cold temperatures can damage the electronic control. When using this appliance for the first time, or when the appliance has not been used for an extended period of time, be sure the appliance has been in temperatures above 32°F (0°C) for at least 3 hours before turning on the power to the appliance.

CAUTION

- Do not heat unopened food containers. Build-up of pressure may cause container to burst and result in injury.
- When heating fat or grease, watch it closely. Grease may catch fire if it becomes too hot.
- Do not use water or flour on grease fires. Smother fire or flame or use dry chemical or foam-type extinguisher. Cover the fire with a pan lid or use baking soda.
- Use dry potholders. Moist or damp potholders on hot surfaces may result in burns from steam. Do not let potholders touch hot cooking areas. Do not use towels or other bulky cloths.
- Wear Proper Apparel - Loose-fitting or hanging garments should never be worn while using the appliance.
- DO NOT TOUCH HEATING ELEMENTS OR INTERIOR SURFACES OF OVEN - Heating elements may be hot even though they are dark in color. Interior surfaces of an oven become hot enough to cause burns. During and after use, do not touch, or let clothing or other flammable materials contact heating elements or interior surfaces of oven until they have had sufficient time to cool. Other surfaces of the appliance may become hot enough to cause burns - among these surfaces are (identification of surfaces - for example, oven vent openings and surfaces near these openings, oven doors, and windows of oven doors).

IMPORTANT SAFETY INSTRUCTIONS

IMPORTANT

Read and follow the below instructions and precautions for unpacking, installing, and servicing your appliance:

- Remove all tape and packaging before using the oven. Destroy the carton and plastic bags after unpacking the oven. Never allow children to play with packaging material.
- Proper Installation—Be sure your appliance is properly installed and grounded by a qualified technician in accordance with the National Electrical Code ANSI/NFPA No. 70 latest edition and local electrical code requirements. In Canada, install in accordance with CSA Standard C22.1, Canadian Electrical code, Part 1, and local electrical code requirements. Install only per installation instructions provided in the literature package for this oven.
- User Servicing—Do not repair or replace any part of the appliance unless specifically recommended in the manuals. All other servicing should be done only by a qualified technician. This reduces the risk of personal injury and damage to the oven.
- Ask your dealer to recommend a qualified technician and an authorized repair service. Know how to disconnect the power to the oven at the circuit breaker or fuse box in case of an emergency.
- Never modify or alter the construction of an oven by removing the leveling legs, panels, wire covers, anti-tip brackets/screws, or any other part of the oven.
- Remove the oven door from any unused oven if it is to be stored or discarded.
- Be sure to have an appropriate foam-type fire extinguisher available, visible, and easily located near the appliance.

IMPORTANT INSTRUCTIONS FOR USING YOUR OVEN

- Never use your appliance for warming or heating the room.
- Use care when opening oven door, lower oven door, or warmer drawer (some models). Stand to the side of the oven when opening the door of a hot oven. Let hot air or steam escape before you remove or replace food in the oven.
- Keep oven vent ducts unobstructed. Touching surfaces in this area when the oven is on may cause severe burns. Do not place plastic or heat-sensitive items on or near the oven vent. These items can melt or ignite.
- Placement of Oven Racks - Always place oven racks in desired location while oven is cool. If rack must be moved while oven is hot, do not let potholder contact hot heating element in oven. Use potholders and grasp the rack with both hands to reposition. Do not let potholders contact the hot heating elements in the oven. Remove all cookware and utensils before moving the rack.
- Do not use a broiler pan without its insert. Broiler pans and inserts allow dripping fat to drain away from the high heat of the broiler. Do not cover the broiler insert with aluminum foil; exposed fat and grease could ignite.
- Protective Liners - Do not use aluminum foil to line surface unit drip bowls or oven bottoms, except as suggested in the manual. Improper installation of these liners may result in a risk of electric shock, or fire.
- Do not cook food on the oven bottom. Always cook in proper cookware and always use the oven racks.

IMPORTANT SAFETY INSTRUCTIONS

IMPORTANT INSTRUCTIONS FOR CLEANING YOUR OVEN

CAUTION

Before manually cleaning any part of the oven, be sure all controls are turned off and the oven is cool. Cleaning a hot oven can cause burns.

- Clean the oven regularly to keep all parts free of grease that could catch fire. Do not allow grease to accumulate.
- Always follow the manufacturer's recommended directions for use of kitchen cleaners and aerosols. Be aware that excess residue from cleaners and aerosols may ignite causing damage and injury.
- Clean ventilating hoods frequently. Grease should not be allowed to accumulate on the hood or filter. Follow the manufacturer's instructions for cleaning hoods.

SELF-CLEANING OVENS

- Clean only the parts listed in this manual. Before using self-clean, remove the broiler pan, any food, utensils, and cookware from the oven. Remove oven racks unless otherwise instructed.
- Do not use oven cleaners. No commercial oven cleaner or oven liner protective coating of any kind should be used in or around any part of the oven.
- Do not clean the oven door gasket. The door gasket is essential for a good seal. Care should be taken not to rub, damage, or move the gasket.
- Some birds are extremely sensitive to the fumes given off during the self-clean cycle of any oven. Move birds to another well-ventilated room.

GROUNDING INSTRUCTIONS

WARNING

Do not use an adapter plug or an extension cord, or remove grounding prong from the power cord. Failure to follow this warning may cause serious injury, fire, or death.

For models factory-equipped with a power cord.

For personal safety, this appliance must be properly grounded. For maximum safety, the power cord must be plugged into an electrical outlet that is the correct voltage, is correctly polarized, and is properly grounded in accordance with local codes. It is the personal responsibility of the consumer to have the appropriate outlet with the correct, properly grounded wall receptacle installed by a qualified electrician.

See the installation instructions packaged with this appliance for complete installation and grounding instructions.

BEFORE SETTING OVEN CONTROLS

Oven vent location

The oven vent is located under the control panel. When the oven is on, warm air passes through this vent. This venting is necessary for proper air circulation in the oven and good baking results. Do not block oven vent.

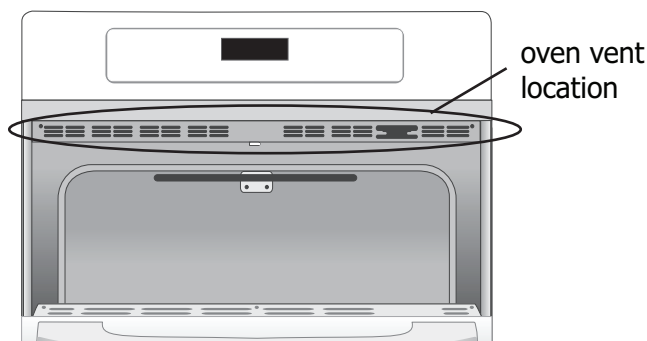

Figure 1: Do not block oven vent location

CAUTION

Always use pot holders or oven mitts when using the oven. When cooking, the oven interior and exterior, as well as the oven racks, will become very hot which can cause burns.

WARNING

Protective Liners — Do not use aluminum foil to line the oven bottom. Only use aluminum foil as recommended in this manual. Improper installation of these liners may result in risk of electric shock or fire.

Removing, replacing, and arranging flat or offset oven racks

To arrange - Always arrange the oven racks when the oven is cool (prior to operating the oven).

To remove - Pull the oven rack straight forward until it reaches the stop position. Lift up front of oven rack slightly and slide out.

To replace - Place the oven rack on the rack guides on both sides of oven walls. Tilt the front of oven rack upward slightly and slide the oven rack back into place. Be sure oven racks are level before using.

Type of oven racks

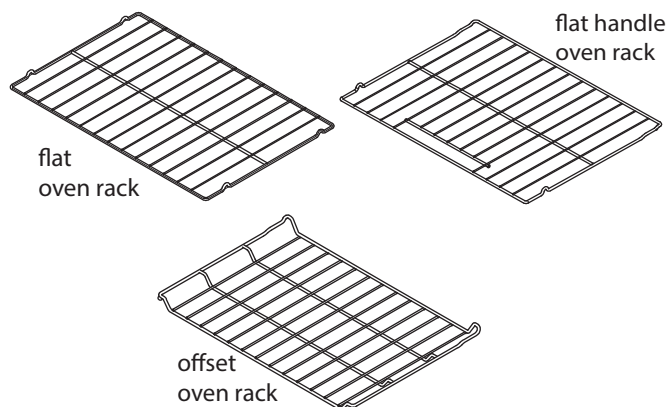

Figure 2: Oven rack types

Oven Rack Descriptions

- Flat oven racks (or the flat handle oven rack) may be used for most cooking needs and may be placed in most oven rack positions.
- The offset oven rack (some models) provides additional stepdown positions from the standard flat rack design. The offset design positions the base of the rack about half of a rack position lower than the flat rack and may be used in most oven rack positions.

Air circulation in the oven

For best air circulation when baking, allow a space of 2 inches (5 cm) around the cookware for proper air circulation. Be sure pans and cookware do not touch each other, the oven door, sides, or back of the oven cavity.

Hot air must be able to circulate around cookware for even heat to reach the food.

OVEN CONTROLS

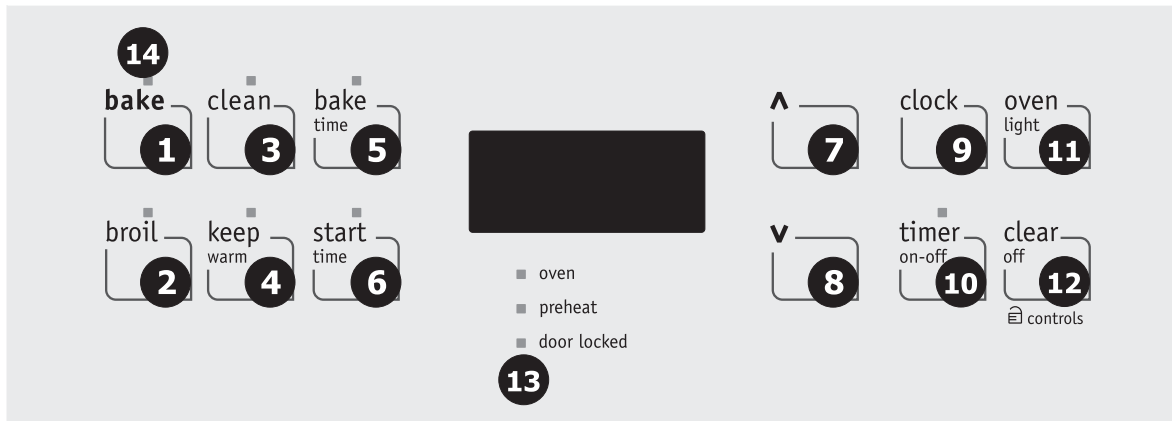

Oven Control Features

1. **Bake** — Use to enter normal baking mode temperature.
2. **Broil** — Use to select the variable broil function.
3. **Clean** — Use to select the self-cleaning cycle.
4. **Keep Warm** — Use to set the Keep Warm feature.
5. **Bake Time** — Use to enter the length of baking time.
6. **Start Time** — Use to set the desired start time for baking. Can be used with bake time to program a delayed bake cycle.
7. **Up Arrow** — Use along with the function keys to select oven temperature, time of day and minute timer.
8. **Down Arrow** — Use along with the other functions to select oven temperature, time of day and minute timer.
9. **Clock** — Use to set the time of day.
10. **Timer On-Off** — Use to set or cancel the minute timer. The minute timer does not start or stop cooking.
11. **Oven Interior Light** — Use to turn oven interior light ON and OFF.
12. **Clear** — Use to stop cooking or clear any function previously entered except the time of day and minute timer.
13. **Oven, Preheat, and Lock lights**— The oven light indicates that the oven is functioning, and it will go on and off throughout the cycle. The preheat light will glow when the oven is first set to operate or if the desired temperature is reset higher than the actual oven temperature. The door locked light will flash until the door locks when the self-clean cycle is in use. It glows constantly after the door locks.
14. **Feature indicator lights**— These lights show which feature is in use.

Setting the Clock

When the oven is first plugged in, or when the power supply to the appliance has been interrupted, the display will flash **12:00**.

To set the clock:

1. Press **clock** once and release.
2. Within 5 seconds push and hold the **up** or **down arrow** until the correct time of day appears in the display.
3. Press **clock** again to accept the new time of day. The clock will automatically set to the selected time of day if **clock** is not pressed.

NOTE

- Read the instructions carefully before using the oven. For satisfactory use of your oven, become familiar with the various features and functions of the oven as described in this manual.
- The graphics on your appliance may not appear exactly as shown. This does not affect operation.

NOTE

- Oven functions will not work if the time of day clock is not set. When using the delay start feature make sure the clock is set to the correct time of day.
- The clock cannot be set or changed when the oven is in use.

Setting Control for Silent Operation

The oven is preset for audible controls operation. Each time a function is selected, an audible tone (beep) sounds. The controls can be programmed for silent operation.

To change between audible and silent operation:

1. Push and hold **start time** for 6 seconds.
2. - - or **SP** will appear in the display. If **SP** appears, the control will operate with normal sounds and beeps. If - - appears, the control is in the silent operation mode.
3. Use the **up** or **down arrow** to switch between modes.
4. When the desired mode appears in the display, release the arrow key and wait 5 seconds for the oven to accept the change and return the display to show the time of day.

Temperature Display (Fahrenheit/Celsius)

The electronic oven control is set to operate in Fahrenheit (°F) when shipped from the factory. The oven can be programmed for any temperature from 170°F to 550°F (77°C to 288°C).

To change the temperature to Celsius (°C) or from °C to °F (control should not be in a bake or clean mode):

1. Press and hold **broil** for 7 seconds until °F or °C appears in the display.
2. Press the **up** or **down arrow** to change between °F and °C.
3. Wait 6 seconds to accept the changes or press **clear off** to accept the changes.

To set 12 or 24 hour time of day display:

1. Press and hold **clock** for 7 seconds. After 7 seconds, **12Hr** or **24Hr** will appear in the display and the control will beep once.
2. Press the **up** or **down arrow** to switch between the 12 and 24 hour time of day display. The display will show either **12Hr** or **24Hr**.
3. Wait 5 seconds or press **clear off** to return to the time of day display.
4. Reset the correct time as described in “[Setting the Clock](#)” on [page 8](#). Please note that if the 24 hour time of day mode was chosen, the clock will now display time from 0:00 through 23:59 hours.

Setting the Timer

The minute timer serves as an extra timer in the kitchen that will beep when the set time has run out. The minute timer can be used alone or during any of the other oven functions.

To set the timer:

1. Press **timer On-Off**.
2. Press the **up arrow** to increase or **down arrow** to decrease the time in one minute increments. The timer can be set for any amount of time from 1 minute to 11 hours and 59 minutes. Holding the arrow keys down will adjust the timer in larger increments.
3. The display shows the timer countdown in minutes if more than 1 hour remains. When less than 1 hour remains, the display will count down in seconds.
4. When the set time has run out, the timer will beep three times. It will continue to beep three times every 8 seconds until **timer on-off** is pressed.

To cancel the minute timer before the set time ends, press the **timer on-off** key.

NOTE

- The indicator light located above the **timer on-off** key will glow while the minute timer is active.
- When the minute timer is in use with any other mode, the minute timer will be shown in the display. To view other functions, press the key for that mode

Operating the Interior Oven Light

The interior oven light(s) will automatically turn on when the oven door is opened. Press the oven light key to turn the interior light(s) on and off whenever the door is closed.

The oven light is located at the upper rear wall of the oven interior and is covered with a glass shield. The glass shield must be in place when the oven is in use. To change the interior oven light, see “[Replacing the oven light](#)” on [page 18](#).

NOTE

The oven light will not operate during the self clean function.

OVEN CONTROLS

Setting Continuous Bake or 12 Hour Energy Saving

The oven control has a built-in 12 hour energy saving feature that will shut off the oven if the control is left on for more than 11 hours and 59 minutes. The oven can be programmed to override this feature for continuous baking.

To set control for continuous baking:

1. Press and hold **timer on-off** for 7 seconds until a tone is heard.
2. Within 5 seconds, press the **up** or **down arrow** to switch between continuous bake and 12 hour energy saving mode. The display will show **— — hr** or **12hr**. If **— — hr** appears, the oven will be set to continuous baking. If **12hr** appears, the oven is set to 12 hour energy saving mode.
3. Wait 5 seconds or press **clear off** to accept the changes.

Setting Oven Lockout

The control can be programmed to lock the oven door and lock the oven control keys. The oven lockout feature prevents the oven from being accidentally turned on. It does not disable the clock, minute timer, or the interior oven light.

To set control for oven lockout feature:

1. Press **clear off** and hold for 3 seconds. The **door locked** indicator light will flash and the motor driven door lock will begin to close automatically. Do not open the oven door while the indicator light is flashing. Allow about 15 seconds for the oven door to lock. Once the oven door is locked, **Loc** will appear in display.
2. To cancel the oven lockout feature, press **clear off** and hold for 3 seconds. The control will unlock the oven door and resume normal operation.

Setting Bake

The time of day must be set in order to operate the oven.

To set controls for baking:

1. Press **bake**. **— — °** appears in the display.
2. The display will show **350°F (177°C)**. Within 5 seconds, press the **up** or **down arrow** to adjust the temperature.
3. 8 seconds after the **up** or **down arrow** key is released, the oven will begin preheating. When the set baking temperature is reached, the preheat indicator light will turn off and the oven control will beep.
4. To cancel the baking function, press **clear off**.

To change oven temperature while baking, press the **up** or **down arrow** to increase or decrease the set temperature.

For best bake results:

- Fully preheat the oven before baking items like cookies, cakes, biscuits, and breads.
- When using any single rack, position the rack so that the food is in the center of the oven.
- For best results when baking cakes using two oven racks, place racks in positions 2 and 4 (See [Figure 3](#)).
- When baking using two oven racks, position cookware as shown in [Figure 4](#). Allow at least 2 inches (5 cm) of space between cookware for proper air circulation.
- Dark or dull bakeware absorbs more heat than shiny bakeware. It may be necessary to reduce oven temperature and cook time to prevent overbrowning of some foods. Dark bakeware is recommended for pies. Shiny bakeware is recommended for cakes, cookies, and muffins.

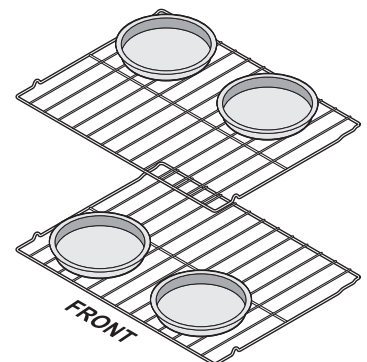
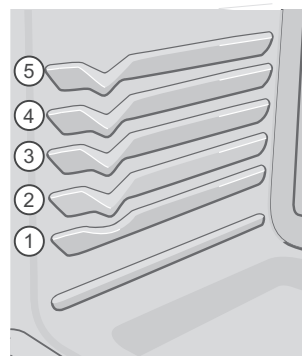

Figure 3: Rack positions Figure 4: Pan spacing

OVEN CONTROLS

Timed Bake and Delay Start Features

The bake time and start time controls operate the features that will turn the oven on and off at the times you select in advance. The oven can be programmed to start immediately and shut off automatically (timed bake) or to begin baking with a delayed start time (delay start).

CAUTION

Use caution with the timed bake and delay start features. Foods that can easily spoil such as milk, eggs, fish, or poultry, should be chilled in the refrigerator first. They should not sit in the oven more than 1 hour before cooking begins. Remove promptly after cooking stops.

To program the oven to begin baking immediately and to shut off automatically (timed bake):

1. Be sure that the clock shows the correct time of day.
2. Place the food in the oven.
3. Press **bake**. — — —° appears in the display.
4. Within 5 seconds, press the **up** or **down arrow**. The display will show **350°F** (177°C). By holding the **up** or **down arrow**, the temperature will adjust in 5°F increments (1° if the control is set to display °C).
5. Wait 6 seconds to accept the temperature.
6. Press **bake time**. 0:00 will flash in the display.
7. Press the **up** or **down arrow** until the desired baking time appears in the display.
8. The oven will turn on and begin heating.

To change oven temperature or bake time after baking has started:

1. Press the function you want to change.
2. Press the **up** or **down arrow** to adjust the setting.

When bake time runs out:

END will appear in the display window, and the oven will shut off automatically. The control will beep three times every 25 seconds until **clear off** is pressed.

To program oven for a delayed start time and to shut-off automatically (delayed start bake):

1. Be sure that the clock shows the correct time of day.
2. Place the food in the oven.
3. Press **bake**. — — —° appears in the display.
4. Within 5 seconds, press the **up** or **down arrow**. The display will show **350°F** (177°C). By holding the **up** or **down arrow**, the temperature will adjust in 5°F increments (1° if the control is set to display °C). Wait 6 seconds to accept the temperature.
5. Press **bake time**. 0:00 will flash in the display
6. Press the **up** or **down arrow** until the desired baking time appears. Wait 6 seconds for the control to accept the time.
7. Press **start time**. The earliest possible start time will appear in the display.
8. Press the **up** or **down arrow** until the desired start time appears and wait 6 seconds for the controls to accept the choice. Once the controls are set, the control calculates the time when baking will start and stop.
9. The oven will turn on at the delayed start time and begin heating.

NOTE

When the control is set for a delayed timed bake, the time of day is displayed until the delayed timed bake start time is reached. When baking, the oven temperature is shown in the display. To see cook time remaining, press **bake time**. To see the time of day, press **clock**.

OVEN CONTROLS

Setting Broil

Broiling is a method of cooking by direct heat under the broil element of the oven. A beep indicates when the broil temperature is reached. Be sure you center the broiler pan directly under the broil element for best results. Arrange oven rack while oven is still cool. Position the rack as needed. The broiler pan and its insert (both available by mail order) allow dripping grease to drain and be kept away from high heat of the broiler. Do not use the pan without its insert. Do not cover the insert with foil. The exposed grease could ignite.

CAUTION

If an oven fire occurs, close oven door and turn off the oven. If the fire continues, throw baking soda on the fire or use a fire extinguisher. Do not put water or flour on the fire. Flour may be explosive and water can cause a grease fire to spread and cause personal injury.

To set for broiling:

1. Arrange the oven rack while oven is still cool.
2. Press **broil**. — — ° will appear in the display.
3. Press the **up** or **down arrow** until the desired broil setting level appears in the display. Press the **up arrow** for **HI** broil or the **down arrow** for **LO** broil. Most foods may be broiled at the **HI** broil setting. Select the **LO** broil setting to avoid excess browning or drying of foods that should be cooked to the well-done stage.
4. Place the insert on the broiler pan, then place the food on the insert. Do not use the pan without the insert or cover the insert with aluminum foil. The exposed grease could ignite.
5. Place the pan on the oven rack.
6. Broil on one side until food is browned. Turn and broil the other side.

NOTE

Always pull the rack out to the stop position before turning or removing food.

7. When broiling is finished, press **clear off**.

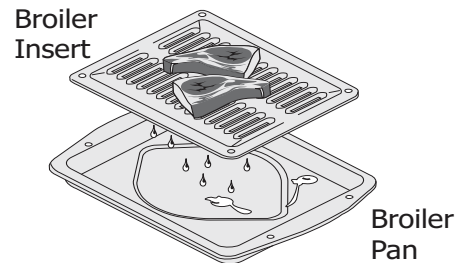

Figure 5: Broiling accessories

For best broiling results:

- For optimum browning, preheat for 5 minutes.
- Broil one side until the food is browned; turn and cook on the second side. Season and serve.
- Always pull the rack out to the stop position before turning or removing food.
- Always use the broiler pan and its insert when broiling. It allows the dripping grease to be kept away from the high heat of the broil element (See [Figure 5](#)).
- Do not use the broil pan without the insert. Do not cover the broil pan insert with foil. The exposed grease could catch fire.
- If using a searing grill (available by mail order), preheat the insert, pan, and grill for 5 to 10 minutes before placing your meat.

The Keep Warm Feature

The keep warm control turns on and maintains an oven temperature of 170°F (77°C). The keep warm feature may be used without any other cooking operations or can be set to function after cooking has finished using delay start with bake time or bake time. The keep warm feature will keep oven baked foods warm for up to 3 hours after cooking has finished. After 3 hours, the keep warm feature will shut the oven off automatically.

Warm tips:

- Always start with hot food. Do not use the warm feature to heat cold food.
- Food in heat-safe glass and glass ceramic containers may need higher temperature settings compared to food in regular containers.
- Avoid repeated openings of the oven. It will allow hot air to escape and the food to cool.
- Aluminum foil may be used to cover food to increase moisture content.

To set keep warm:

1. Arrange the interior oven racks and place baked food in oven.
2. Press **keep warm**. — — — will appear in the display and the keep warm indicator light will turn on.
3. Press the **up** or **down arrow** to start. **Hld** will appear in the display.
4. To turn **keep warm** off at any time, press **clear off**.

To set keep warm to turn on automatically:

1. Arrange the interior oven racks and place food in the oven. Set the oven for timed bake or delayed start with timed bake. See [“Timed Bake and Delay Start Features”](#) on [page 11](#).
2. Press **keep warm**. — — — will appear in the display and the **keep warm** indicator light will turn on.
3. Press the **up** or **down arrow** to start. Keep warm is set to turn on automatically after timed bake or delayed start bake has finished.
4. To turn **keep warm** off at any time, press **clear off**. The **keep warm** indicator light will turn off.

NOTE

After selecting keep warm, you must press **start** within 6 seconds, or the keep warm function will turn off automatically.

Adjusting the oven temperature

The oven thermostat is factory calibrated. If the oven is cooking too hot or cool for the recipe times, you can adjust the thermostat, so the oven cooks hotter or cooler than the temperature displayed.

To adjust the oven temperature:

1. Press and hold the **bake** key for 6 seconds. If the oven control has the original factory calibration, the display will read **0**.
2. The temperature can be adjusted up or down 35°F (19°C) by pushing and holding the **up** or **down arrow**. Adjust until the desired temperature adjustment appears in the display. When lowering the oven temperature, a minus sign (-) will appear before the number displayed.
3. When you have made the desired adjustment, wait 6 seconds or press **clear off** to accept the change.

OVEN CONTROLS

The Sabbath Feature (for use on the Jewish Sabbath and Holidays)

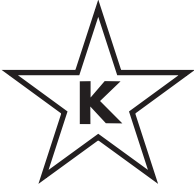

Use the **bake time** and **start time** keys to set the Sabbath feature.

For further assistance, guidelines for proper usage, and a complete list of models with the Sabbath feature, please visit the web at <http://www.star-k.org>.

The Sabbath feature may only be used with the Bake function. Once the oven is properly set using bake with the Sabbath feature active, the oven will remain on until cancelled. The Sabbath feature overrides the factory preset 12 hour energy saving feature.

If the oven light is needed during the Sabbath, press **oven light** before activating the Sabbath feature. Once the oven light is turned on and the Sabbath feature is active, the oven light will remain on until the Sabbath feature is turned off. If the oven light needs to be off, be sure to turn the oven light off before activating the Sabbath feature.

IMPORTANT

It is advised to not activate any cooking function other than bake while the Sabbath feature is active.

To begin baking immediately and activate the Sabbath feature:

1. Be sure that the clock is set with the correct time of day.
2. Place the food in the oven.
3. Press **bake**. — — — appears in the display.
4. Within 5 seconds, press the **up** or **down arrow**. The display will show **350°F** (177°C). By holding the **up** or **down arrow**, the temperature can be adjusted in 5°F increments (1°C if the control is set to display °C).
5. If you desire to set the oven control for a timed bake or a delayed start do so at this time. If not, skip this step and continue to step 6. (Refer to “[Timed Bake and Delay Start Features](#)” section on [page 11](#) for complete instructions.) Remember the oven will shut down after using **bake time** or **start time** and therefore may only be used once during the Sabbath/Jewish Holidays. The maximum Bake time is 11 hours and 59 minutes.
6. The oven will turn on and begin heating
7. Press and hold both **bake time** and **start time** for at least 3 seconds. **SAb** will appear in the display. Once

SAb appears in the display, the oven control will no longer beep or display any further changes, and the oven is properly set for the Sabbath feature.

8. The oven may be turned off at any time by first pressing the **clear off** key (this will turn the oven off only). To turn off the Sabbath feature and return the oven to normal operation, hold both the **bake time** and **start time** controls for at least 3 seconds. **SAb** will disappear from the display, and the oven may now be used for conventional cooking.

NOTE

- You may change the oven temperature once baking has started by pressing the **up** or **down arrow**. The oven temperature will be adjusted in 5°F increments with each press of the arrow (1°C if the control is set to display °C).
- Only the following controls will function after setting the Sabbath feature: **up** and **down arrows**, **bake**, and **clear off**. All other features will not function once the Sabbath feature is properly activated.
- The display will not show temperature changes or sound any audible tones when the oven is set with the Sabbath feature

Power failure while using Sabbath feature:

If you experience a power failure or power interruption, the oven will shut off. When power is returned, the oven will not turn back on. The oven will remain set with the Sabbath feature, and the food may be safely removed from the oven while still in the Sabbath feature; however, the oven cannot be turned back on until after the Sabbath. After the Sabbath observance turn off the Sabbath feature. Press and hold both **bake time** and **start time** for at least 3 seconds. **SAb** will disappear from the display, and the oven may be used with all normal functions.

Self-Cleaning

⚠ CAUTION

- Do not line the oven walls, racks, bottom, or any other part of the oven with aluminum foil. Doing so will block heat distribution, produce poor baking results and cause permanent damage to the oven interior (aluminum foil will melt to the interior surface of the oven).
- The health of some birds is extremely sensitive to the fumes given off during the self-cleaning cycle of any oven. Move birds to another well-ventilated room.
- During the self-cleaning cycle, the outside of the oven can become very hot to the touch. Do not leave small children unattended near the appliance.
- Do not force the oven door open. This can damage the automatic door locking system.
- Use caution when opening the door after the self-cleaning cycle is completed. The oven may still be very hot. Stand to the side of the oven door when opening the door to allow hot air or steam to escape.

A self-cleaning oven cleans itself with high temperatures (well above normal cooking temperatures) which eliminate soils completely or reduces them to a fine powdered ash you can wipe away with a damp cloth.

What to expect during self-cleaning

While in self-clean mode, the oven heats to temperatures much higher than those used in normal cooking. Sounds of metal expansion and contraction are normal.

Odors are normal as the food soil is being removed. Smoke may appear through the oven vent.

If heavy spills are not wiped up before cleaning, they may flame and cause more smoke and odor than usual. This is normal and safe and should not cause alarm. If available, use an exhaust fan during the self-cleaning cycle.

➔ IMPORTANT

Adhere to the following cleaning precautions:

- Do not use oven cleaners or protective coatings in or around any part of the oven interior. Do not clean the oven door gasket. Take care not to rub, damage, or remove the gasket or use any cleaning substances on the oven door gasket (See [Figure 6](#)). Doing so could cause damage and reduce the efficiency of the oven's performance.
- Clean any soil from the oven frame, door liner outside the oven door gasket, and the small area at the front center of the oven bottom with soap and water (See [Figure 6](#)). These areas heat sufficiently to burn soil on.
- Remove any excessive spills from the oven cavity before starting the self-cleaning cycle. To clean, use hot, soapy water and a cloth. Large spills can cause heavy smoke or fire when subjected to high temperatures.
- Do not use aluminum foil or liners in the oven. These items are not made to withstand the very high temperatures of a self-clean cycle and will melt.
- Remove all oven racks and accessories. If oven racks are not removed before a self-clean, they will lose their special coating and will no longer slide in and out of the oven cavity effortlessly.
- Oven racks accidentally left in the oven during self clean may be wiped down after cooling with a high-temperature cooking oil to lubricate them.



Figure 6: Clean around the oven door gasket

OVEN CONTROLS

Setting A Self-Clean Cycle

NOTE

The kitchen area should be well ventilated using an open window, ventilation fan, or exhaust hood during the self-clean cycle. This will help eliminate the normal odors associated with the self-cleaning cycles.

To set the controls for a self-clean (3 hours) or a delayed start self-clean (3 hours):

NOTE

If you do not want to start a **delayed** self-clean cycle, skip steps 2 and 3.

1. Be sure the clock shows the correct time of day.
2. Press **start time**.
3. Press and hold **up arrow** to scroll to the time to start the delayed self-clean cycle. Release the arrow when the desired time is displayed.
4. Press **clean**. - - appears in the display.
5. Press the **up arrow** once.
6. As soon as the controls are set, the motor driven door lock will begin to close automatically and the **door locked** indicator light will flash. Do not open the oven door while the light is flashing (it takes about 15 seconds for the oven door to lock).
7. **CLn** will appear in the display during the self-clean cycle, and the **door locked** light will glow until the self-cleaning cycle is complete or cancelled and the oven temperature has cooled.

When the self-clean cycle is complete:

1. **CLn** will appear in the display, and **door locked** light will continue to glow.
2. Once the oven has cooled down for about 1 hour and the **door locked** light has gone out, the oven door can be opened.
3. When the oven is cooled down sufficiently, wipe away any residue or ash with a damp cloth or paper towel.

To stop or interrupt a self-cleaning cycle:

If it becomes necessary to stop or interrupt a self-clean cycle:

1. Press **clear Off**.
2. Once the oven has cooled down for about 1 HOUR and the **door lock** light has gone out, the oven door can be opened.
3. Restart the self-clean cycle once all conditions have been corrected.

Cleaning Various Parts of Your Oven

Before cleaning any part of the oven, be sure all controls are turned off and the oven is cool. Remove spills and any heavy soiling as soon as possible. Regular cleaning will reduce the number of major cleaning later.

| Surface Type | Recommendation |
|--|---|
| Aluminum and Vinyl | Use hot, soapy water and a cloth. Dry with a clean cloth. |
| Painted body parts Painted decorative trims | Use a soft cloth and clean with mild dish detergent and water or a 50/50 solution of vinegar and water. Follow by rinsing the area with clean water; dry and polish with a soft cloth. Glass cleaners may be used if sprayed on a soft cloth first. Do not spray liquids directly on the oven control and display area. Do not use large amounts of water on the control panel. Excess water on the control area may cause damage to the appliance. Do not use other liquid cleaners, abrasive cleaners, scouring pads, or paper towels. They will damage the finish. |
| EasyCare™ Stainless Steel | Your oven finish may be Easy Care™ Stainless Steel (some models). Clean the stainless with warm soapy water using a clean sponge or cloth. Rinse with clean water and dry with a soft clean cloth. Do not use any store bought cleaners like stainless steel cleaners or any other types of cleaners containing any abrasive, chlorides, chlorine, or ammonia. It is recommended to use mild dish soap and water or a 50/50 solution of water and vinegar. |
| Porcelain enamel broiler pan and insert (available by mail order) Door liner and body parts | Gentle scouring with a soapy scouring pad will remove most spots. Rinse with a 1:1 solution of clear water and ammonia. If necessary, cover difficult spots with an ammonia-soaked paper towel for 30 to 40 minutes. Rinse with clean water and a damp cloth, and then scrub with a soap-filled scouring pad. Rinse and wipe dry with a clean cloth. Remove all cleaners or the porcelain may become damaged during future heating. |
| Oven racks | Oven racks must be removed from oven cavity. Clean by using a mild, abrasive cleaner following manufacturer's instructions. Rinse with clean water and dry. |
| Oven door | Use soap and water to thoroughly clean the top, sides, and front of the oven door. Rinse well. You may use a glass cleaner on the outside glass of the door. Do not immerse the door in water. Do not spray or allow water or the glass cleaner to enter the door vents. Do not use oven cleaners, cleaning powders, or any harsh abrasive cleaning materials on the outside of the oven door. Do not clean the oven door gasket. On self-clean models, the oven door gasket is made of a woven material which is essential for a good seal. Care should be taken not to rub, damage, or remove this gasket. |

CARE AND CLEANING

Removing and Replacing the Oven Door

⚠ CAUTION

The door is heavy. For safe, temporary storage, lay the door flat with the inside of the door facing down.

To remove the oven door:

1. Open oven door completely, horizontal with floor (See [Figure 7](#)).
2. Pull the door hinge locks on both left and right door hinges down from the oven frame completely toward the oven door (See [Figure 8](#)). A tool such as a small flat-blade screwdriver may be required.
3. Firmly grasp both sides of oven door along the door sides. Do not use the oven door handle (See [Figure 9](#)).
4. Close the door to approximately 10 degrees from the door frame (See [Figure 9](#)).
5. Lift the oven door hinge arms over the roller pins located on each side of the oven frame (See [Figure 9](#)).

To Replace Oven Door:

1. Firmly grasp both sides of oven door along the door sides. Do not use the oven door handle (See [Figure 9](#)).
2. Holding the oven door at the same angle as the removal position, seat the hook of the hinge arm over the roller pins located on each side of the oven door frame (See [Figure 9](#) and [Figure 10](#)). The hook of the hinge arms must be fully seated onto the roller pins.
3. Fully open the oven door, horizontal with floor (See [Figure 7](#)).
4. Push the door hinge locks up toward and into the oven frame on both left and right oven door hinges to the locked position (See [Figure 8](#)).
5. Close the oven door.

➔ IMPORTANT

Special Door Care Instructions - Most oven doors contain glass that can break. Do not close the oven door until all the oven racks are fully in place. Do not hit the glass with pots, pans, or any other object. Scratching, hitting, jarring, or stressing the glass may weaken its structure causing an increased risk of breakage at a later time.

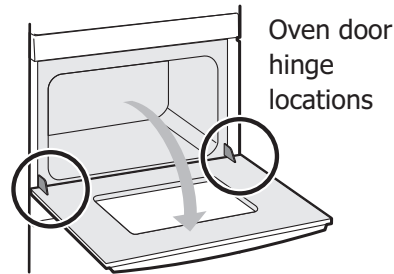

Figure 7: Door hinge location

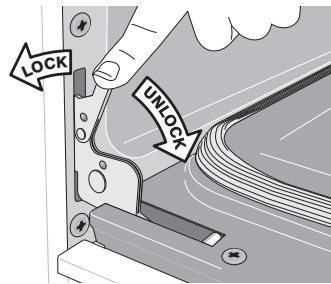

Figure 8: Door hinge locks

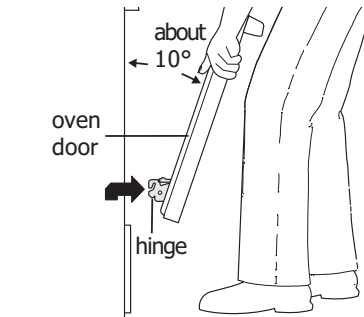

Figure 9: Holding door for removal

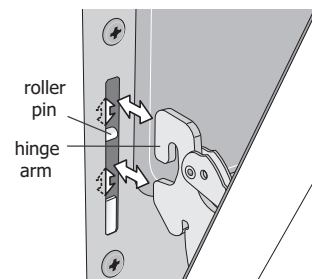

Figure 10: Replacement and location of hinge arm and roller pin

Replacing the oven light

CAUTION

Be sure the oven is unplugged and all parts are cool before replacing oven light.

The interior oven lights are located at the rear of the oven cavity and are covered with a glass shield. The glass shield must be in place whenever the oven is in use (See [Figure 11](#)).

Replacing the oven interior light bulb:

1. Turn electrical power off at the main source or unplug the appliance.
2. Remove interior oven light shield by turning a quarter turn counter-clockwise.
3. Replace bulb with a new T-4 type Halogen 25 watt appliance bulb.

NOTE

Do not allow your fingers to touch the new bulb when replacing. This will shorten the life of the bulb. Use a paper towel or cotton glove while handling the new bulb when installing.

4. Replace glass oven light shield by rotating clockwise.
5. Turn power back on again at the main source (or plug the appliance back in).
6. Be sure to reset the time of day on the clock

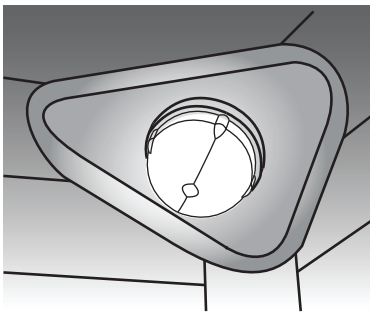

Figure 11: Wall oven Halogen light

BEFORE YOU CALL

Solutions to Common Problems

Before you call for service, review the following list. It may save you time and expense. Possible solutions are provided with the problem listed:

| Problem | Solution |
|--|---|
| Poor baking results | <ul style="list-style-type: none">• Many factors effect baking results. Use proper oven rack position. Center food in the oven and space pans to allow air to circulate. Preheat oven to the set temperature before placing food in the oven. Try adjusting the recipe's recommended temperature or baking time. See "Adjusting the oven temperature" on page 12 if you feel the oven is too hot or cold. |
| Oven does not operate. | <ul style="list-style-type: none">• The time of day is not set. The oven clock must first be set in order to operate the oven.• Be sure oven controls are set properly. See "Setting the Clock" on page 7 and review instructions for the desired cooking function in this manual.• Service wiring is not complete. |
| Oven light does not work. | <ul style="list-style-type: none">• Be sure the oven light is secure in the socket. See "Replacing the oven light" on page 18. |
| Flames inside oven or smoking from oven vent. | <ul style="list-style-type: none">• Excessive spills in oven. Grease or food spilled onto oven bottom or oven cavity. Wipe up excessive spills before starting oven. If flames or excessive smoke are present when using broil, see "Setting Broil" on page 11. |
| Self clean does not work. | <ul style="list-style-type: none">• Oven control not set properly. Review "Self-Cleaning" on page 14. |
| Oven racks discolored or do not slide easily. | <ul style="list-style-type: none">• Oven racks left in oven cavity during self clean. Always remove oven racks from oven cavity before starting a self-clean cycle. Clean by using a mild abrasive cleaner following manufacturer's instructions. Rinse with clean water, dry, and replace in oven. |
| Oven smokes excessively when broiling. | <ul style="list-style-type: none">• Incorrect setting. Follow broiling instructions in "Setting Broil" on page 11.• Meat too close to the broil element. Reposition broil rack to provide proper clearance between the meat and broil element. Remove excess fat from meat. Cut remaining fatty edges to prevent curling.• Grease build up on oven surfaces. Regular cleaning is necessary when broiling frequently. Grease or food splatters will cause excessive smoking. |
| Oven control panel beeps and displays any F or E code error. | <ul style="list-style-type: none">• Oven control has detected a fault or error condition. Press clear off to clear the error code. Try bake or broil function. If the F or E code error repeats, turn off power to appliance, wait 5 minutes and then repower appliance. Set clock with correct time of day. Try bake or broil function again. If fault recurs, press clear off to clear. |
| Soil not completely removed after self clean. | <ul style="list-style-type: none">• Self Clean was interrupted. Review instructions in Self Clean section.• Excessive spills on oven bottom. Clean before starting self clean.• Failure to clean soil from the oven frame, the door liner outside the oven door gasket, and the small area at the front center of the oven bottom. These areas are not in the self-cleaning area, but they get hot enough to burn on residue. Clean these areas before starting the self-cleaning cycle. Burned-on residue can be cleaned with a stiff nylon brush and water or a nylon scrubber. Be careful not to damage the oven gasket. |

Your appliance is covered by a one year limited warranty. For one year from your original date of purchase, Electrolux will pay all costs for repairing or replacing any parts of this appliance that prove to be defective in materials or workmanship when such appliance is installed, used and maintained in accordance with the provided instructions.

Exclusions

This warranty does not cover the following:

1. Products with original serial numbers that have been removed, altered or cannot be readily determined.
2. Product that has been transferred from its original owner to another party or removed outside the USA or Canada.
3. Rust on the interior or exterior of the unit.
4. Products purchased "as-is" are not covered by this warranty.
5. Food loss due to any refrigerator or freezer failures.
6. Products used in a commercial setting.
7. Service calls which do not involve malfunction or defects in materials or workmanship, or for appliances not in ordinary household use or used other than in accordance with the provided instructions.
8. Service calls to correct the installation of your appliance or to instruct you how to use your appliance.
9. Expenses for making the appliance accessible for servicing, such as removal of trim, cupboards, shelves, etc., which are not a part of the appliance when it is shipped from the factory.
10. Service calls to repair or replace appliance light bulbs, air filters, water filters, other consumables, or knobs, handles, or other cosmetic parts.
11. Surcharges including, but not limited to, any after hour, weekend, or holiday service calls, tolls, ferry trip charges, or mileage expense for service calls to remote areas, including the state of Alaska.
12. Damages to the finish of appliance or home incurred during installation, including but not limited to floors, cabinets, walls, etc.
13. Damages caused by: services performed by unauthorized service companies; use of parts other than genuine Electrolux parts or parts obtained from persons other than authorized service companies; or external causes such as abuse, misuse, inadequate power supply, accidents, fires, or acts of God.

DISCLAIMER OF IMPLIED WARRANTIES; LIMITATION OF REMEDIES

CUSTOMER'S SOLE AND EXCLUSIVE REMEDY UNDER THIS LIMITED WARRANTY SHALL BE PRODUCT REPAIR OR REPLACEMENT AS PROVIDED HEREIN. CLAIMS BASED ON IMPLIED WARRANTIES, INCLUDING WARRANTIES OF MERCHANTABILITY OR FITNESS FOR A PARTICULAR PURPOSE, ARE LIMITED TO ONE YEAR OR THE SHORTEST PERIOD ALLOWED BY LAW, BUT NOT LESS THAN ONE YEAR. ELECTROLUX SHALL NOT BE LIABLE FOR CONSEQUENTIAL OR INCIDENTAL DAMAGES SUCH AS PROPERTY DAMAGE AND INCIDENTAL EXPENSES RESULTING FROM ANY BREACH OF THIS WRITTEN LIMITED WARRANTY OR ANY IMPLIED WARRANTY. SOME STATES AND PROVINCES DO NOT ALLOW THE EXCLUSION OR LIMITATION OF INCIDENTAL OR CONSEQUENTIAL DAMAGES, OR LIMITATIONS ON THE DURATION OF IMPLIED WARRANTIES, SO THESE LIMITATIONS OR EXCLUSIONS MAY NOT APPLY TO YOU. THIS WRITTEN WARRANTY GIVES YOU SPECIFIC LEGAL RIGHTS. YOU MAY ALSO HAVE OTHER RIGHTS THAT VARY FROM STATE TO STATE.

If You Need Service

Keep your receipt, delivery slip, or some other appropriate payment record to establish the warranty period should service be required. If service is performed, it is in your best interest to obtain and keep all receipts. Service under this warranty must be obtained by contacting Electrolux at the addresses or phone numbers below.

This warranty only applies in the USA and Canada. In the USA, your appliance is warranted by Electrolux Major Appliances North America, a division of Electrolux Home Products, Inc. In Canada, your appliance is warranted by Electrolux Canada Corp. Electrolux authorizes no person to change or add to any obligations under this warranty. Obligations for service and parts under this warranty must be performed by Electrolux or an authorized service company. Product features or specifications as described or illustrated are subject to change without notice.

USA
1.800.944.9044
Electrolux Home Products, Inc.
10200 David Taylor Drive
Charlotte, NC 28262



Canada
1.800.265.8352
Electrolux Canada Corp.
5855 Terry Fox Way
Mississauga, Ontario, Canada
L5V 3E4