



Free-Standing Electric

Ranges

Safety Instructions 2-5

Operating Instructions

Kitchen Timer 18

Oven 13-30

 Adjust Oven Thermostat 19

 Baking or Roasting 14

 Broiling, Broiling Guide 15

 Controls 11, 12

 Convection Oven 20-23

 Lower Oven Drawer 30

 Preheating 14

 Probe 17

 Sabbath Feature 28

 Self-Cleaning 24, 25

 Special Features 26-27

 Timed Baking and Roasting 16

 Warming Drawer 29

Surface Units 6-10

 Cookware 7

 Knob-Controlled Models 9-10

Care and Cleaning

 Glass Cooktop 36, 37

 Lift-Off Oven Door 32

 Light 35

 Racks 33

 Removable Warming Drawer/Lower Oven Drawer Pan 34

 Storage Drawer 34

 Surfaces 31

Troubleshooting Tips 38-42

Accessories 44

Consumer Support

 Consumer Support 45

 Ownership Registration 46

 Warranty 49

Owner's Manual

PCB910
PCB940
PCB980

Write the model and serial numbers here:

Model # _____

Serial # _____

You can find them on a label behind the drawer or behind the lower oven door on the front of the range frame.

IMPORTANT SAFETY INFORMATION. READ ALL INSTRUCTIONS BEFORE USING.

⚠ WARNING

Read all safety instructions before using the product. Failure to follow these instructions may result in fire, electric shock, serious injury or death.

ANTI-TIP DEVICE



⚠ WARNING

- All ranges can tip.
- BURNS or other SERIOUS INJURIES can result.
- INSTALL and CHECK the ANTI-TIP bracket following the instructions supplied with the bracket.

To reduce the risk of tipping the range, the range must be secured by a properly installed anti-tip bracket. See installation instructions shipped with the bracket for complete details before attempting to install.

For Freestanding Ranges:

To check if the bracket is installed and engaged properly, remove the storage drawer or kick panel and look underneath the range to see that the leveling leg is engaged in the bracket. On models without a storage drawer or kick panel, carefully tip the range forward. The bracket should stop the range within 10.2 cm (4 inches). If it does not, the bracket must be reinstalled. If the range is pulled from the wall for any reason, always repeat this procedure to verify the range is properly secured by the anti-tip bracket.

Never completely remove the leveling legs or the range will not be secured to the anti-tip device properly.

If you did not receive an anti-tip bracket with your purchase, call 1.800.561.3344 receive one at no cost. For installation instructions of the bracket, visit www.GEAppliances.ca

⚠ WARNING

GENERAL SAFETY INSTRUCTIONS

- Use this appliance for its intended purpose as described in this Owner's Manual.
- Be sure your appliance is properly installed and grounded by a qualified installer in accordance with the provided installation instructions.
- Do not attempt to repair or replace any part of your range unless it is specifically recommended in this manual. All other servicing should be transferred to a qualified technician.
- Before performing any service, unplug the range or disconnect the power supply at the household distribution panel by removing the fuse or switching off the circuit breaker.
- Do not leave children alone—children should not be left alone or unattended in an area where an appliance is in use. They should never be allowed to climb, sit or stand on any part of the appliance.
- **CAUTION**: Do not store items of interest to children above a range or on the backguard of a range—children climbing on the range to reach items could be seriously injured.
- Use only dry pot holders—moist or damp pot holders on hot surfaces may result in burns from steam. Do not let pot holders touch hot surface units or heating elements. Do not use a towel or other bulky cloth in place of pot holders.
- Never use your appliance for warming or heating the room.
- Do not touch the surface units, the heating elements or the interior surface of the oven. These surfaces may be hot enough to burn even though they are dark in color. During and after use, do not touch, or let clothing or other flammable materials contact the surface units, areas nearby the surface units or any interior area of the oven; allow sufficient time for cooling first. Other surfaces of the appliance may become hot enough to cause burns. Potentially hot surfaces include the cooktop, areas facing the cooktop, oven vent opening, surfaces near the opening and crevices around the oven door.
- Do not heat unopened food containers. Pressure could build up and the container could burst, causing an injury.
- Do not use aluminum foil to line the drip pans or anywhere in the oven, except as described in this manual. Misuse could result in damage to the range and shock or fire hazard.
- Avoid scratching or impacting glass doors, cooktops or control panels. Doing so may lead to glass breakage. Do not cook on a product with broken glass. Shock, fire or cuts may occur.
- Cook meat and poultry thoroughly—meat to at least an internal temperature of 71.1°C (160°F) and poultry to at least an internal temperature of 82.2°C (180°F). Cooking to these temperatures usually protects against foodborne illness.

⚠ WARNING

KEEP FLAMMABLE MATERIALS AWAY FROM THE RANGE.

- Do not store or use flammable materials in an oven or near the cooktop, including paper, plastic, pot holders, linens, wall coverings, curtains, drapes and gasoline or other flammable vapors and liquids.
- Never wear loose-fitting or hanging garments while using the appliance. These garments may ignite if they contact hot surfaces, causing severe burns.
- Do not let cooking grease or other flammable materials accumulate in or near the range. Grease in the oven or on the cooktop may ignite.
- Clean ventilating hoods frequently. Grease should not be allowed to accumulate on the hood or filter.

⚠ WARNING

IN THE EVENT OF A FIRE, TAKE THE FOLLOWING STEPS TO PREVENT THE FIRE FROM SPREADING:

- Do not use water on grease fires. Never pick up a flaming pan. Turn the controls off. Smother a flaming pan on a surface unit by covering the pan completely with a well-fitting lid, cookie sheet or flat tray. Use a multi-purpose dry chemical or foam-type fire extinguisher.
- If there is a fire in the oven during baking, smother the fire by closing the oven door and turning the oven off or by using a multi-purpose dry chemical or foam-type fire extinguisher.
- If there is a fire in the oven during self-clean, turn the oven off and wait for the fire to go out. Do not force the door open. Introduction of fresh air at self-clean temperatures may lead to a burst of flame from the oven. Failure to follow this instruction may result in severe burns.

IMPORTANT SAFETY INFORMATION. READ ALL INSTRUCTIONS BEFORE USING.

▲ WARNING

COOKTOP SAFETY INSTRUCTIONS

- Never leave the surface units unattended at medium or high heat settings. Boilovers cause smoking and greasy spillovers that may catch on fire.
- Never leave oil unattended while frying. If allowed to heat beyond its smoking point, oil may ignite, resulting in fire that may spread to surrounding cabinets. Use a deep fat thermometer whenever possible to monitor oil temperature.
- To avoid oil spillover and fire, use a minimum amount of oil when shallow pan-frying and avoid cooking frozen foods with excessive amounts of ice.
- Use proper pan size—select cookware having flat bottoms large enough to cover the surface heating element. The use of undersized cookware will expose a portion of the surface unit to direct contact and may result in ignition of clothing. Proper relationship of cookware to surface unit will also improve efficiency.
- Only certain types of glass, glass/ceramic, earthenware or other glazed containers are suitable for cooktop service; others may break because of the sudden change in temperature.
- To minimize the possibility of burns, ignition of flammable materials and spillage, the handle of a container should be turned toward the center of the range without extending over nearby surface units.
- When preparing flaming foods under a hood, turn the fan on.

▲ WARNING

RADIANT COOKTOP SAFETY INSTRUCTIONS

- Use care when touching the cooktop. The glass surface of the cooktop will retain heat after the controls have been turned off.
- Do not cook on a broken cooktop. If glass cooktop should break, cleaning solutions and spillovers may penetrate the broken cooktop and create a risk of electric shock. Contact a qualified technician immediately.
- Avoid scratching the glass cooktop. The cooktop can be scratched with items such as knives, sharp instruments, rings or other jewelry and rivets on clothing.
- Do not place or store items that can melt or catch fire on the glass cooktop, even when it is not being used. If the cooktop is inadvertently turned on, they may ignite. Heat from the cooktop or oven vent after it is turned off may cause them to ignite also.
- Use CERAMA BRYTE® ceramic Cooktop Cleaner and CERAMA BRYTE® Cleaning Pad to clean the cooktop. Wait until the cooktop cools and the indicator light goes out before cleaning. A wet sponge or cloth on a hot surface can cause steam burns. Some cleaners can produce noxious fumes if applied to a hot surface. NOTE: Sugar spills are an exception. They should be scraped off while still hot using an oven mitt and a scraper. See the *Cleaning the glass cooktop* section for detailed instructions.
- Read and follow all instructions and warnings on the cleaning cream label.

⚠ WARNING

OVEN SAFETY INSTRUCTIONS

- Stand away from the range when opening the oven door. Hot air or steam which escapes can cause burns to hands, face and/or eyes.
- Keep the oven vent unobstructed.
- Keep the oven free from grease buildup. Grease in the oven may ignite.
- Place oven racks in desired location while oven is cool. If rack must be moved while oven is hot, do not let pot holder contact hot heating element in oven.
- When using cooking or roasting bags in the oven, follow the manufacturer's directions.
- Pull the oven rack to the stop-lock position when loading and unloading food from the oven. This helps prevent burns from touching hot surfaces of the door and oven walls.
- Do not leave items such as paper, cooking utensils or food in the oven when not in use. Items stored in an oven can ignite.
- Do not use aluminum foil to line the oven bottom. Foil may trap or reflect heat, leading to a shock or fire hazard.

⚠ WARNING

SELF-CLEANING OVEN SAFETY INSTRUCTIONS

The self-cleaning feature operates the oven at temperatures high enough to burn away food soils in the oven. Follow these instructions for safe operation.

- Before operating the self-clean cycle, remove pans, shiny metal oven racks and other utensils from the oven. Only gray porcelain-coated oven racks may be left in the oven. Do not use self-clean to clean other parts, such as drip pans or bowls.
- Before operating the self-clean cycle, wipe grease and food soils from the oven. Excessive amount of grease may ignite, leading to smoke damage to your home.
- If the self-cleaning mode malfunctions, turn the oven off and disconnect the power supply. Have it serviced by a qualified technician.
- Do not clean the door gasket. The door gasket is essential for a good seal. Care should be taken not to rub, damage or move the gasket.
- Do not use oven cleaners. No commercial oven cleaner or oven liner protective coating of any kind should be used in or around any part of the oven.

⚠ WARNING

WARMING DRAWER/LOWER OVEN DRAWER SAFETY INSTRUCTIONS (some models)

- The purpose of the warming drawer is to hold hot cooked foods at serving temperature. Bacteria will grow in food while it is below 60°C (140°F). Do not put cold food in warming drawer. Do not heat food for more than 2 hours. Failure to follow these instructions may result in foodborne illness.
- Do not leave paper products, plastics, canned food or combustible materials in the drawer. They may ignite.
- Do not touch the heating element or the interior surface of the drawer. These surfaces may be hot enough to cause burns.
- Use care when opening the drawer. Open the drawer a crack and let hot air or steam escape before removing or replacing food. Hot air or steam that escapes can cause burns to hands, face and/or eyes.
- Do not use aluminum foil to line the warming drawer. Foil is an excellent heat insulator and will trap heat beneath it. This will upset the performance of the drawer and potentially cause a fire hazard.

For models with a glass cooktop.

⚠ WARNING

FIRE HAZARD: Never leave the range unattended with the cooktop on medium or high settings. Keep flammable items away from the cooktop. Turn off all controls when done cooking. Failure to follow these instructions can result in fire, serious injury or death.

NOTE: Throughout this manual, features and appearance may vary from your model.



Never cook directly on the glass. Always use cookware.



Always place the pan in the center of the surface unit you are cooking on.



Do not slide cookware across the control or cooktop surface because it can scratch the glass. The glass is scratch-resistant, not scratchproof.

About the radiant surface units

The radiant cooktop features heating units beneath a smooth glass surface.

Cooktop temperatures increase with the number of surface units that are on. With 3 or 4 units turned on, surface temperatures are high. Always use caution when touching the cooktop.

An indicator light will come on when the surface unit is turned on.

The appropriate **HOT SURFACE** indicator light will glow when its corresponding radiant element is turned on and will remain on until the surface has cooled below 65.6°C (150°F).

NOTE:

Hot surface indicator light will:

- Stay on even after the unit is turned off.
- Glow brightly until the unit has cooled below 65.6°C (150°F).

NOTE: A slight odor is normal when a new cooktop is used for the first time. It is caused by the heating of new parts and insulating materials and will disappear in a short time.

NOTE: On models with light-colored glass cooktops, it is normal for the cooking zones to change color when hot or cooling down. This is temporary and will disappear as the glass cools to room temperature.

It is safe to place hot cookware from the oven or surface on the glass cooktop when the surface is cool.

Even after the surface units are turned off, the glass cooktop retains enough heat to continue cooking. To avoid overcooking, remove pans from the surface units when the food is cooked. Avoid placing anything on the surface unit until it has cooled completely.

- Water stains (mineral deposits) are removable using the cleaning cream or full strength white vinegar.
- Use of window cleaner may leave an iridescent film on the cooktop. The cleaning cream will remove this discoloration.
- Don't store heavy items above the cooktop. If they drop onto the cooktop, they can cause damage.
- Do not use the surface as a cutting board.

Selecting types of cookware for glass cooktop models.

www.GEAppliances.ca

The following information will help you choose cookware which will give good performance on glass cooktops. See insert for cookware to use with induction cooktops.

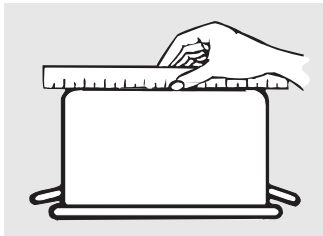

Check pans for flat bottoms by using a straight edge.



Pans with rounded, curved, ridged or warped bottoms are not recommended.

Stainless Steel:
recommended

Aluminum:
heavy weight recommended

Good conductivity. Aluminum residues sometimes appear as scratches on the cooktop but can be removed if cleaned immediately. Because of its low melting point, thin weight aluminum should not be used.

Copper Bottom:
recommended

Copper may leave residues which can appear as scratches. The residues can be removed, as long as the cooktop is cleaned immediately. However, do not let these pots boil dry. Overheated metal can bond to glass cooktops. An overheated copper bottom pot will leave a residue that will permanently stain the cooktop if not removed immediately.

Porcelain Enamel on Cast Iron:
recommended if bottom of pan is coated

Porcelain Enamel on Steel:
not recommended
Heating empty pans can cause permanent damage to cooktop glass. The enamel can melt and bond to the ceramic cooktop.

Glass-ceramic:
not recommended
Poor performance. Will scratch the surface.

Stoneware:
not recommended
Poor performance. May scratch the surface.

Cast Iron:
not recommended—unless designed specifically for glass cooktops
Poor conductivity and slow to absorb heat. Will scratch the cooktop surface.

NOTE: Follow all cookware manufacturer's recommendations when using any type of cookware on the ceramic cooktop.

For Best Results

- Place only dry pans on the surface elements. Do not place lids on the surface elements, particularly wet lids.
- Do not use woks that have support rings. This type of wok will not heat on glass surface elements.
- We recommend that you use only a flat-bottomed wok. They are available at your local retail store. The bottom of the wok should have the same diameter as the surface element to ensure proper contact.
- Some special cooking procedures require specific cookware such as pressure cookers, deep-fat fryers, etc. All cookware must have flat bottoms and be the correct size.

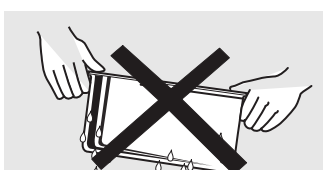

Do not place wet pans on the glass cooktop.



Do not use woks with support rings on the glass cooktop.



Use flat-bottomed woks on the glass cooktop.

⚠ WARNING

FOOD POISON HAZARD: Bacteria may grow in food at temperatures below 60°C (140°F).

- Always start with hot food. Do not use warm settings to heat cold food.
- Do not warm food for more than 2 hours.

Failure to follow these instructions may result in foodborne illness.

Warming Zone
Zone réchaud
Set / Off

Warming Zone Levels
Min 1 Med 2 Max 3
Niveau de chaleur du zone réchaud

6

7

8

Using the Warming Zone (on some models)

To use the WARMING ZONE:

- 1 Touch the WARMING ZONE SET/OFF pad.
- 2 Touch the 1 (LO), 2 (MED) or 3 (HI) pad to select the desired control setting. "WARMER ON" will be in the control display.

To turn off the WARMING ZONE:

Touch the WARMING ZONE SET/OFF pad.

NOTE: The CLEAR/OFF pad will not turn off the WARMING ZONE.

For best results, all foods on the WARMING ZONE should be covered with a lid or aluminum foil.

Always use pot holders or oven mitts when removing food from the WARMING ZONE, as cookware will be hot.

- Do not use plastic wrap to cover food. Plastic may melt onto the surface and be very difficult to clean.
- Use only cookware recommended for top-of-range cooking.

Using the surface units—*Knob-controlled models.* www.GEAppliances.ca

Throughout this manual, features and appearance may vary from your model.

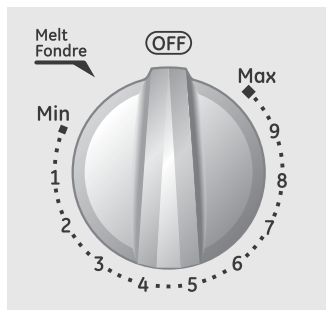

At both OFF and HI the control clicks into position. You may hear slight clicking sounds during cooking, indicating the control is maintaining your desired setting.

Be sure you turn the control knob to OFF when you finish cooking.

How to Set

Push the knob in and turn in either direction to the setting you want.

For glass cooktop surfaces:

A HOT COOKTOP indicator light, on the cooktop, will glow when any radiant element is turned on. It will remain on until the surface is cooled to approximately 65.6°C (150°F).

Indicator light will:

- Come on when the unit is turned on or hot to the touch.
- Stay on even after the unit is turned off.
- Glow until the unit is cooled to approximately 65.6°C (150°F).



On some models.

Dual and Triple Surface Units and Control Knobs *(on some models)*

The surface unit has 2 or 3 cooking sizes to select from so you can match the size of the unit to the size of the cookware you are using.

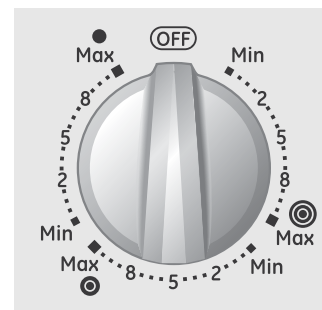

Models with a Triple Surface Unit only:

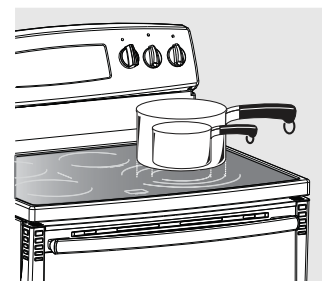

Temperature Limiter

Every radiant surface unit has a temperature limiter.

The temperature limiter protects the glass cooktop from getting too hot. It is normal for it to cycle when the cooktop is in use.

The temperature limiter may cycle the units off more frequently for a time if:

- The pan boils dry.
- The pan bottom is not flat.
- The pan is off-center.
- There is no pan on the unit.

Throughout this manual, features and appearance may vary from your model.

Models with a Bridge Burner only:

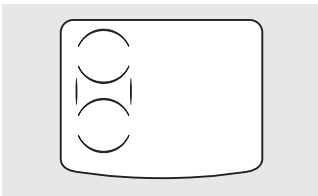
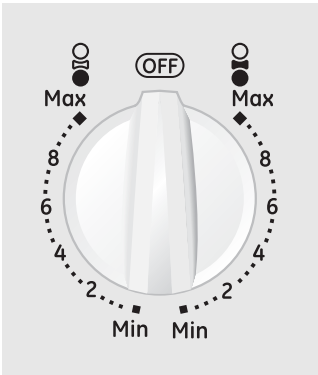

Using the Bridge Burner *(on some models)*

To use the bridge burner, turn the left-front control knob to the BRIDGE BURNER settings.

For full bridge surface unit operation, also turn on the left-rear surface unit.

To use only the front surface unit, turn the control knob to the FRONT BURNER settings.

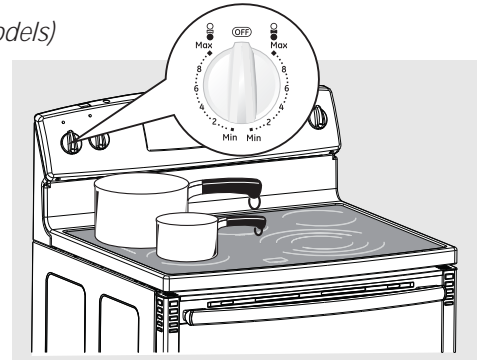

Home Canning Tips

Be sure the canner is centered over the surface unit.

Make sure the canner is flat on the bottom.

To prevent burns from steam or heat, use caution when canning.

Use recipes and procedures from reputable sources. These are available from manufacturers such as Ball® and Kerr®

Flat-bottomed canners are recommended. Use of water bath canners with rippled bottoms may extend the time required to bring the water to a boil.

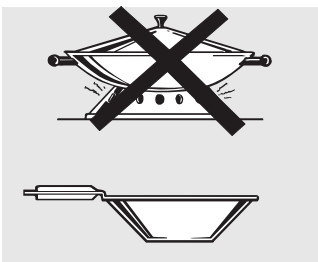

Use only flat-bottomed woks.

Wok Cooking

We recommend that you use only a flat-bottomed wok. They are available at your local retail store.

Do not use woks that have support rings.

Do not use round-bottom woks. You could be seriously burned if the wok tipped over.

Using the oven controls.

www.GEAppliances.ca

Throughout this manual, features and appearance may vary from your model. See the control panel below that matches your model.

Convection
Auto recipe conversion

Bake
Cuire

Roast
Rôtir

Conversion de recettes

Broil
Griller

Bake
Cuire

Hi / Lo

Warming
Zone
Tiroir réchaud

Set / Off

TrueTemp



Warming Zone Levels
Min Med Max
1 2 3
Niveau de chaleur du zone réchaud

4

5

OFF
ARRÊT

6

7

8

Control Lockout
9 0
Verrouillage des contrôles

START
DÉPART

Cook Time
Temps de cuisson

Start Time
Heure de départ

Timer
Minuterie

ON / OFF

Clock
Horloge

Self Clean
Autonettoyage

ON / OFF

Convection
Auto recipe conversion

Bake
Cuire

Roast
Rôtir

Conversion de recettes

Broil
Griller

Bake
Cuire

Hi / Lo

Probe
Sonde

Warming
Zone
Tiroir réchaud

Set / Off

TrueTemp



Warming Zone Levels
Min Med Max
1 2 3
Niveau de chaleur du zone réchaud

4

5

OFF
ARRÊT

6

7

8

Control Lockout
9 0
Verrouillage des contrôles

START
DÉPART

Cook Time
Temps de cuisson

Start Time
Heure de départ

Timer
Minuterie

ON / OFF

Clock
Horloge

Self Clean
Autonettoyage

ON / OFF

BROIL HI/LO Pad

Touch the BROIL HI/LO pad once for HI Broil.
To change to LO Broil, touch the BROIL HI/LO pad again.
Touch the START pad.
When broiling is finished, touch the CLEAR/OFF pad.

BAKE Pad

Touch the BAKE pad.
Touch the number pads to set the desired oven temperature.
Touch the START pad.
When baking is finished, touch the CLEAR/OFF pad.

CONVECTION COOK Pad

Touch the CONVECTION BAKE, or CONVECTION ROAST pad.
Touch the number pads to set the desired oven temperature.
Touch the START pad.
When cooking is finished, touch the CLEAR/OFF pad.

PROBE Pad

Touch when using the probe to cook food.
See the *Using the Probe* section.

SELF CLEAN Pad

Touch to self-clean the oven.
See the *Using the Self-Cleaning* section.

OFF Pad

Touch to cancel ALL oven operations except the clock and timer.

Safety Instructions

Operating
Instructions

Care and Cleaning

Troubleshooting Tips

Consumer Support

START Pad

Must be touched to start any cooking or cleaning function.

OVEN LIGHT Pad

Touch to turn the oven lights on or off.

TIMER ON/OFF Pad

Touch to set the kitchen timer.
See the *Using the Kitchen Timer* section.

COOK TIME

Touch this pad and then touch the number pads to set the amount of time you want your food to cook. The oven will shut off when the cooking time has run out.

START TIME Pad

Use along with the COOK TIME or SELF CLEAN pads to set the oven to start and stop automatically at a time you set.

CLOCK Pad

NOTE: When setting times, you are setting hours and minutes only. The lowest time you can set is one minute.

Touch the CLOCK pad.
Touch the number pads.
Touch the START pad.

The clock must be set to the correct time of day for the automatic oven timing functions to work properly. The time of day cannot be changed during a timed baking or self-cleaning cycle.

If your oven was set for a timed oven operation and a power outage occurred, *the clock and all programmed functions must be reset.* The time of day will flash in the display when there has been a power outage.

CONTROL LOCKOUT Pad

Your control will allow you to lock out the touch pads and the cooktop so they cannot be activated when touched.

To lock the controls and cooktop:
Touch and hold the CONTROL LOCKOUT /RANGE LOCKOUT pad for 3 seconds. The oven display will show "Loc on."

To unlock the controls:
Touch and hold the CONTROL LOCKOUT /RANGE LOCKOUT pad for 3 seconds. " The oven display will show " Off " "

The CONTROL LOCKOUT mode affects all touch pads. No touch pads will work when this feature is activated.

WARMING DRAWER

The warming drawer will keep hot, cooked foods at serving temperature. Always start with hot food.

Touch the WARMING DRAWER pad. "WARMER ON" and "1" are lit on the display and "Set" begins to blink. On the number pads, touch 1 for Low, 2 for Medium or 3 for High. The display "1" changes corresponding to the number pad selected. The warming drawer starts automatically after you touch 1, 2 or 3. "WARMER ON" and the number remain lit. "Set" stops blinking.

On some models there are just 2 levels, 1 for Low and 2 for High.

On some models, press START.

To cancel, touch the WARMING DRAWER pad.

NOTE: Touching the CLEAR/OFF pad does not turn off the warming drawer.

WARMING ZONE

Touch to keep hot, cooked food warm. See the *Using the Warming Zone* section.

Using the oven.

To avoid possible burns, place the racks in the desired position before you turn on the oven.

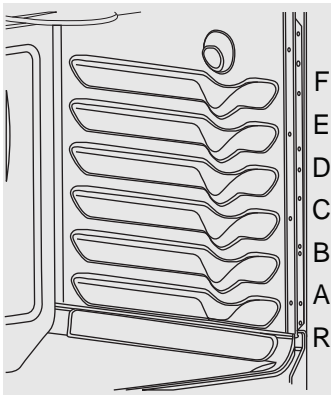

The number of rack positions may vary by model.

The oven has 6 rack positions.

It also has a special low rack position (R) for extra large items, such as a large turkey.

Before you begin...

The racks have stops, so that when placed correctly on the supports, they will stop before coming completely out and will not tilt.

When placing and removing cookware, pull the rack out until it stops.

On some models, the bake heating element is under the oven floor. Do not place foods on the oven bottom for cooking.

To remove a rack, pull it toward you, tilt the front end up and pull it out.

To replace, place the end of the rack (stop-locks) on the support, tilt up the front and push the rack in.

CAUTION

When you are using a rack in the lowest position (A), you will need to use caution when pulling the rack out. We recommend that you pull the rack out several inches and then, using two pot holders, pull the rack out by holding the sides of it. The rack is low and you could be burned if you place your hand in the middle of the rack and pull all the way out. Be very careful not to burn your hand on the door when using the rack in the lowest position (A).

Aluminum Foil

Do not use aluminum foil on the bottom of the oven.

Never entirely cover a rack with aluminum foil. This will disturb the heat circulation and result in poor baking.

A smaller sheet of foil may be used to catch a spillover by placing it on a lower rack several inches below the food.

Extension Racks (on some models)

Extension racks have a frame that locks into the rack supports on both sides.

Once the frame is locked into place, always pull the rack out, by its upper front rail, to its full extension stop position, when placing or removing cookware. If extension racks are difficult to extend, lubricate the racks with the graphite lubricant provided with your oven. Remove the rack from the oven, remove debris in the slide tracks with a paper towel, shake the graphite lubricant and place 4 small drops on the two bottom tracks of the left and right sides. Open and close the rack several times to distribute the lubricant.

To order additional graphite lubricant, read the Assistance and Accessories section at the beginning of this manual.

To Remove An Extension Rack;

1. Make sure the rack is pushed all the way into the oven.
2. Firmly holding onto both the upper and lower front rails, pull the rack toward you, tilt the front end up and pull the rack out.



To Replace An Extension Rack;

1. Place the curved end of the rack onto the rack supports.
2. Tilt the front of rack up and push the rack in.

If extension racks are difficult to replace or remove, wipe the oven rack supports with cooking oil. Do not wipe oil on the rack slides.

To avoid possible burns, place the racks in the desired position before you turn on the oven.

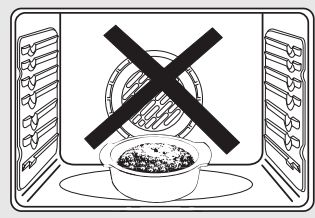

Do not place foods directly on the oven floor.

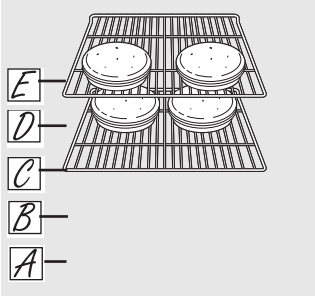

Preheating and Pan Placement

To avoid possible burns, place the racks in the desired position before you turn on the oven.

Preheat the oven if the recipe calls for it. Preheating is necessary for good results when baking cakes, cookies, pastries and breads.

If baking four cake layers at the same time, place two layers on rack C and two layers on rack E. Stagger pans on the rack so one is not directly above the other.

Baking results will be better if food is centered in the oven as much as possible. Angel food cake is the exception and should be placed on the bottom oven rack (position A). Follow package directions on prepackaged and frozen foods for pan placement. Pans should not touch each other or the walls of the oven. If you need to use two racks, stagger the pans so one is not directly above the other. Leave approximately 3.8 cm (1½") between pans and from the front, back and sides of oven wall.

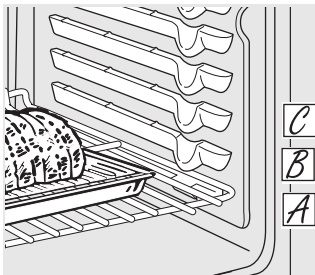

How to Set the Oven for Baking or Roasting

- 1 Touch the **BAKE** pad.
- 2 Touch the number pads until the desired temperature is displayed.
- 3 Touch the **START** pad.

The oven will start automatically.

- 4 Check food for doneness at the minimum time on the recipe. Cook longer if necessary.
- 5 Touch the **CLEAR/OFF** pad when baking is finished, and then remove the food from the oven.

When the oven reaches the selected temperature, the oven control will beep several times and the display will show the oven temperature.

NOTE: You will hear the convection fan (on some models) while the oven is preheating. The fan will stop after the oven is preheated and the display shows your set temperature. This is normal.

To change the oven temperature during the **BAKE** cycle, touch the **BAKE** pad and then the number pads to get the new temperature.

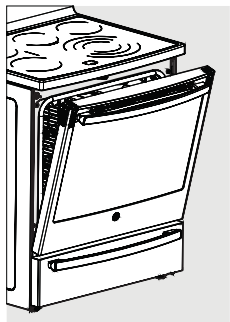

Door is not provided with broil position.

How to Set the Oven for Broiling

If your range is connected to 208 volts, rare steaks may be broiled by preheating the broiler and positioning the oven rack one position higher.

Use LO Broil to cook foods such as poultry or thick cuts of meat thoroughly without overbrowning them.

- 1 Place the meat or fish on a broiler grid in a broiler pan designed for broiling.
- 2 Follow suggested rack positions in the *Broiling Guide*.
- 3 Touch the BROIL HI/LO pad once for HI Broil.
To change to LO Broil, touch the BROIL HI/LO pad again.
- 4 Touch the START pad.
- 5 When broiling is finished, touch the CLEAR/OFF pad.

Broiling Guide

Preheat the broiler for 2 minutes to improve performance.

The size, weight, thickness, starting temperature and your preference of doneness will affect broiling times. This guide is based on meats at refrigerator temperature.

Food	Doneness	Type or Thickness	Rack Position*	Comments
Beef	Rare (60°C/140°F)	Steaks - 2.5 cm (1") thick	E or F (food should be 2.5 cm to 7.6 cm [1" to 3"] from broil element)	Steaks less than 2.5 cm (1") thick are difficult to cook rare. They cook through before browning. To prevent curling of meat, slash fat at 2.5 cm (1") intervals.
	Medium (71.1°C/160°F)	Steaks -19 mm to 2.5 cm (3/4" to 1") thick	E (food should be 7.6 cm to 10.2 cm [3" to 4"] thick from broil element)	
	Well Done (76.7°C/170°F)	Steaks -19 mm to 2.5 cm (3/4" to 1") thick or Ground Beef Patties	D or E (food should be 7.6 cm to 12.7 cm [3" to 5"] from broil element)	
Chicken		Breast, boneless	C (food should be 20.3 cm to 22.9 cm [8" to 9"] from broil element)	Broil skin-side-down first.
		Breast, bone-in	C (food should be 17.8 cm to 20.3 cm [7" to 8"] from broil element)	
Fish Fillets		13 mm to 2.5 cm (1/2" to 1") thick	D or E (food should be 7.6 cm to 15.2 cm [3" to 6"] from broil element)	Handle and turn very carefully.
Pork Chops	Well Done (76.7°C/170°F)	19 mm (3/4" to 1") thick	D (food should be 15.2 cm to 17.8 cm [6" to 7"] from broil element)	To prevent curling of meat, slash fat at 2.5 cm (1") intervals.

*Use rack position A for the smaller, 2-rack-position oven.

Using the timed baking and roasting features. *(on some models)*

NOTE: Foods that spoil easily—such as milk, eggs, fish, stuffings, poultry and pork—should not be allowed to sit for more than 1 hour before or after cooking. Room temperature promotes the growth of harmful bacteria. Be sure that the oven light is off because heat from the bulb will speed harmful bacteria growth.



How to Set an Immediate Start and Automatic Stop

The oven will turn on immediately and cook for a selected length of time. At the end of the cooking time the oven will turn off automatically.

- 1 Touch the BAKE pad.
- 2 Touch the number pads to set the desired oven temperature.
- 3 Touch the COOK TIME pad.

NOTE: If your recipe requires preheating, you may need to add additional time to the length of the cooking time.

- 4 Touch the number pads to set the desired length of cooking time. The minimum cooking time you can set is 1 minute.
The oven temperature that you set and the cooking time that you entered will be in the display.
- 5 Touch the START pad.

NOTE: An attention tone will sound if you are using timed baking and do not touch the START pad.

The oven will turn ON, and the display will show the cooking time countdown and the changing temperature starting at 37.8°C (100°F). (The temperature display will start to change once the oven temperature reaches 37.8°C [100°F].) When the oven reaches the temperature you set, 3 beeps will sound.

The oven will continue to cook for the set amount of time, then turn off automatically, unless the WARM feature was set. See the *How to Set the Upper Oven for Warming* section.

- 6 Touch the CLEAR/OFF pad to clear the display if necessary. Remove the food from the oven. Remember, even though the oven turns off automatically, food left in the oven will continue cooking after the oven turns off.

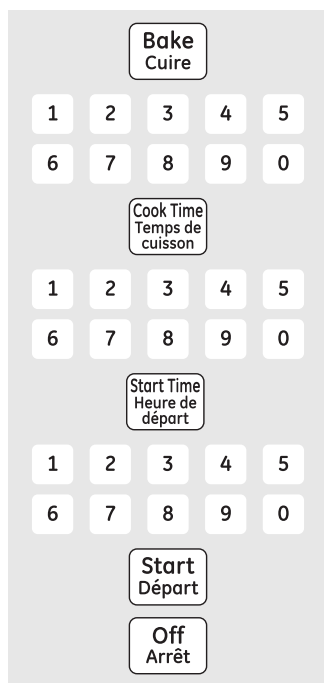

How to Set a Delayed Start and Automatic Stop

The oven will turn on at the time of day you set, cook for a specific length of time and then turn off automatically.

Make sure the clock shows the correct time of day.

- 1 Touch the BAKE pad.
- 2 Touch the number pads to set the desired oven temperature.
- 3 Touch the COOK TIME pad.

NOTE: If your recipe requires preheating, you may need to add additional time to the length of the cooking time.

- 4 Touch the number pads to set the desired length of cooking time. The minimum cooking time you can set is 1 minute.
The oven temperature that you set and the cooking time that you entered will be in the display.
- 5 Touch the DELAY START pad.
- 6 Touch the number pads to set the time of day you want the oven to turn on and start cooking.
- 7 Touch the START pad.

NOTE: An attention tone will sound if you are using timed baking and do not touch the START pad.

NOTE: If you would like to check the times you have set, touch the DELAY START pad to check the start time you have set or touch the COOK TIME pad to check the length of cooking time you have set.

When the oven turns ON at the time of day you set, the display will show the cooking time countdown and the changing temperature starting at 37.8°C (100°F). (The temperature display will start to change once the oven temperature reaches 37.8°C [100°F].) When the oven reaches the temperature you set, beeps will sound.

The oven will continue to cook for the set amount of time, then turn off automatically.

- 8 Touch the CLEAR/OFF pad to clear the display if necessary. Remove the food from the oven. Remember, even though the oven turns off automatically, food left in the oven will continue cooking after the oven turns off.

Using the probe. *(on some models)*

www.GEAppliances.ca

For many foods, especially roasts and poultry, internal food temperature is the best test for doneness. The temperature probe takes the guesswork out of roasting by cooking foods to the exact doneness you want.

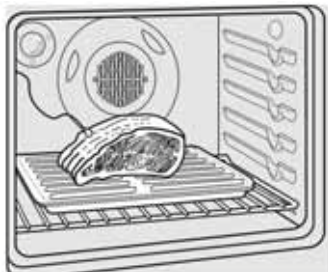

The temperature probe has a skewer-like probe at one end and a plug at the other end that goes into the outlet in the oven.

CAUTION

To prevent burns, do not unplug the probe from the oven outlet until the oven has cooled.

Use of probes other than the one provided with this product may result in damage to the probe or oven control.

Use the handles of the probe and plug when inserting and removing them from the food and outlet.

■ To avoid damaging your probe, do not use tongs to pull on the cable when removing it.

■ To avoid breaking the probe, make sure food is completely defrosted before inserting.

After preparing the meat and placing it on a trivet or a broiler pan grid, follow these directions for proper probe placement.

Insert the probe completely into the meat. It should not touch bone, fat or gristle.

NOTE: Failure to fully insert the probe into the meat may result in poor cooking performance because the probe will sense the oven air vs. the food temperature.

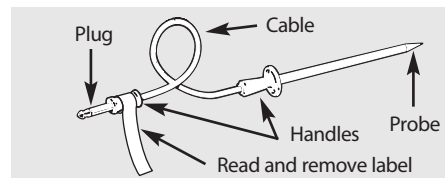

■ Never leave your probe inside the oven during a self-cleaning or broil cycle.

■ Do not store the probe in the oven.

For roasts with no bone, insert the probe into the meatiest part of the roast. For bone-in ham or lamb, insert the probe into the center of the lowest large muscle.

Insert the probe into the center of dishes such as meat loaf or casseroles.

Insert the probe into the meatiest part of the inner thigh from below and parallel to the leg of a whole turkey.

NOTE: Self-clean and Broil settings will not work if the temperature probe is plugged in.

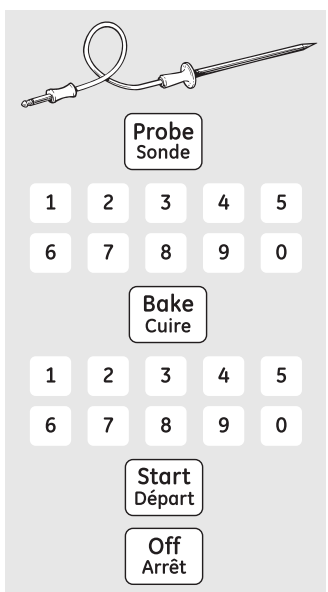
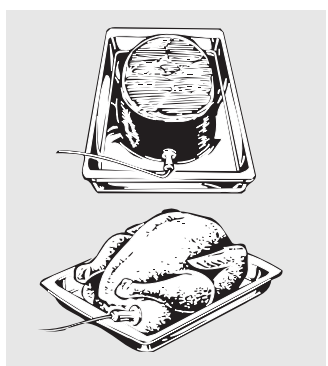

How to Set the Oven For Baking/Roasting When Using the Probe

(on some models)

- 1 Insert the probe fully into the food.
- 2 Plug the probe into the outlet in the oven. Make sure it's pushed all the way in. Close the oven door. Make sure the probe cable is not touching the broil element.
- 3 Touch the PROBE pad. Display will show "Set Probe."
- 4 Touch the number pads to set the desired internal food or meat temperature. The maximum internal temperature for the food that you can set is 93.3°C (200°F).
- 5 Touch the BAKE pad.
- 6 Touch the number pads to set the desired oven temperature.
- 7 Touch the START pad.

The display will flash if the probe is inserted into the outlet and you have not set a probe temperature and touched the START pad.

After the internal temperature of the food reaches 37.8°C (100°F), the changing internal temperature will be shown in the display.

- 8 When the internal temperature of the food reaches the number you have set, the probe and the oven turn off and the oven control signals. To stop the signal, touch the CLEAR/OFF pad. Use hot pads to remove the probe from the food. Do not use tongs to pull on it—they might damage it.

■ If the probe is removed from the oven while probe cooking, the oven will not automatically turn off.

To change the oven temperature during the Bake/Roast cycle, touch the BAKE pad and then the number pads to set the new temperature.

■ You can use the Kitchen Timer even though you cannot use timed oven operations while using the probe.

Using the kitchen timer.

Timer
Minuterie
On / Off

(on some models)

The Kitchen Timer is in hours and minutes. The Kitchen Timer does not control oven operations. The maximum setting on the Kitchen Timer is 9 hours and 59 minutes.

To Set the Kitchen Timer

- 1 Touch the TIMER ON/OFF pad. or *After touching the START pad, SET disappears; this tells you the time is counting down, although the display does not change until one minute has passed. Seconds will not be shown in the display until the last minute is counting down.*
- 2 Touch the number pads until the amount of time you want shows in the display. For example, to set 2 hours and 45 minutes, touch 2, 4 and 5 in that order. If you make a mistake, touch the TIMER ON/OFF pad and begin again.
- 4 When the kitchen timer reaches :00, the control will beep 3 times followed by one beep every 6 seconds until the TIMER ON/OFF pad is touched.

The 6-second tone can be cancelled by following the steps in the Special features of your oven control section under Tones at the End of a Timed Cycle.

- 3 Touch the START pad.

To Reset the Kitchen Timer

If the display is still showing the time remaining, you may change it by touching the TIMER ON/OFF pad then touch the number pads until the time you want appears in the display.

If the remaining time is not in the display (clock, delay start or cooking time are in the display), recall the remaining time by touching the TIMER ON/OFF pad and then touching the number pads to enter the new time you want.

Timer
Minuterie
On / Off

To Cancel the Timer

Touch the TIMER ON/OFF pad twice or touch TIMER OFF.

Adjust the oven thermostat—Do it yourself!

www.GEAppliances.ca

You may find that your new oven cooks differently than the one it replaced. Use your new oven for a few weeks to become more familiar with it. If you still think your new oven is too hot or too cold, you can adjust the thermostat yourself.

Do not use thermometers, such as those found in grocery stores, to check the temperature setting of your oven. These thermometers may vary 20–40 degrees.

NOTE: *This adjustment will only affect baking and roasting temperatures; it will not affect broiling or self-cleaning temperatures. The adjustment will be retained in memory after a power failure.*

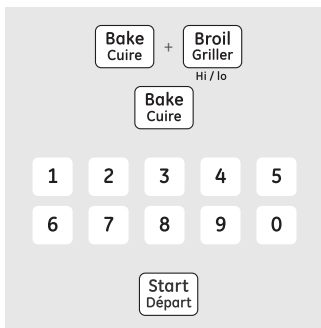

(on some models)

To Adjust the Thermostat

- 1 Touch the BROIL HI/LO and BAKE pads at the same time until the display shows SF.
- 2 Touch the BAKE pad. A two-digit number shows in the display.
Touch BAKE again to alternate between increasing and decreasing the oven temperature.
- 3 The oven temperature can be adjusted up to (+) 19°C (35°F) hotter or (-) 19°C (35°F) cooler. Touch the number pads the same way you read them. For example, to change the oven temperature 15°C, touch 1 and 5.
- 4 When you have made the adjustment, touch the START pad to go back to the time of day display. Use your oven as you would normally.

The type of margarine will affect baking performance!

Most recipes for baking have been developed using high-fat products such as butter or margarine (80% fat). If you decrease the fat, the recipe may not give the same results as with a higher-fat product.

Recipe failure can result if cakes, pies, pastries, cookies or candies are made with low-fat spreads. The lower the fat content of a spread product, the more noticeable these differences become.

Federal standards require products labeled "margarine" to contain at least 80% fat by weight. Low-fat spreads, on the other hand, contain less fat and more water. The high moisture content of these spreads affects the texture and flavor of baked goods. For best results with your old favorite recipes, use margarine, butter or stick spreads containing at least 70% vegetable oil.

Using the convection oven. *(on some models)*

Cook Time
Temps de
cuisson

Convection Cook *(on some models)*

The convection oven comes with one convection cook mode and can be used for 1-Rack Convection Baking or Multi-Rack Convection Baking.



Convection Fan Operation

In a convection oven, a fan circulates hot air over, under and around the food.

This circulating hot air is evenly distributed throughout the oven cavity. As a result, foods are evenly cooked and browned—often in less time with convection heat.

NOTE: To maximize cooking evenness, the fan is designed to rotate in both directions, with a pause in between. This is normal.

The convection fan shuts off when the oven door is opened. DO NOT leave the door open for long periods of time while using convection cooking or you may shorten the life of the convection heating element.

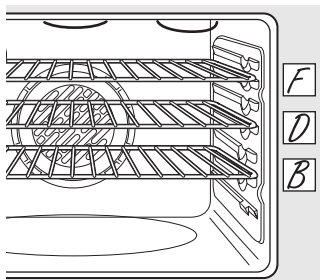

Multi-rack position.

Multi-Rack Convection Baking

Because heated air is circulated evenly throughout the oven, foods can be baked with excellent results using multiple racks.

Multi-rack baking may increase cook times slightly for some foods but the overall result is time saved. Cookies, muffins, biscuits and other quickbreads give very good results with multi-rack baking.

When baking on 3 racks, place one rack in the second (B) position, another rack in the fourth (D) position and the third rack in the sixth (F) position.

For two-rack baking, place one rack in the second (B) rack position. Place the other rack in the fifth (E) rack position.

1-Rack Convection Baking

When convection baking with only 1 rack, place the food so that it is centered with oven convection fan.

Adapting Recipes...

You can use your favorite recipes in the convection oven.

- *Use pan size recommended.*
- *Some package instructions for frozen casseroles or main dishes have been developed using commercial convection ovens. For best results in this oven, preheat the oven and use the temperature on the package.*

Using the convection oven. *(on some models)*

www.GEApliances.ca

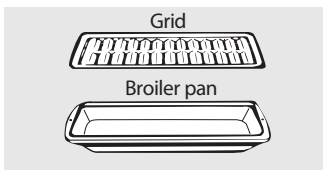

Convection Roast *(on some models)*

- Good for large tender cuts of meat, uncovered.

The convection fan circulates the heated air evenly over and around the food. Meat and poultry are browned on all sides as if they were cooked on a rotisserie. The heated air seals in juices quickly for a moist and tender product while, at the same time, creating a rich golden brown exterior.

When you are convection roasting, it is important that you use a broiler pan and grid for best convection roasting results. The pan is used to catch grease spills and the grid is used to prevent grease spatters.

How to Set the Oven for Convection Baking or Roasting

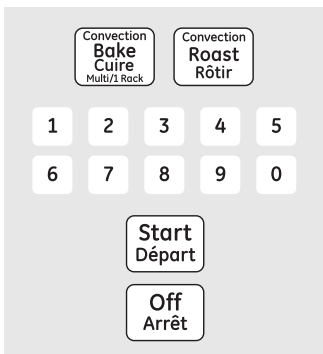

(on some models)

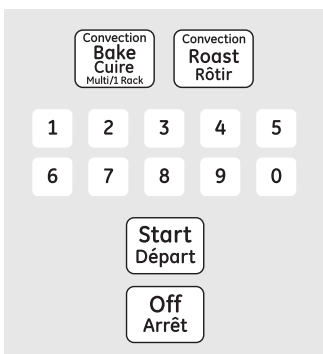

(on some models)

1 Touch the CONVECTION BAKE pad once for multi-rack convection baking. This mode is used for cooking food items on more than one rack (i.e., 2, 3 or more racks) at the same time in convection bake. See the *Multi-Rack Convection Baking* section for more information.

Touch the CONVECTION BAKE pad twice for one-rack convection baking. This mode is used for cooking food items on only one rack in convection bake.

Touch the CONVECTION ROAST pad for convection roasting (on some models).

2 Touch the number pads to set the oven temperature.

3 Touch the START pad.

NOTE: If the *Auto Recipe™ Conversion Feature* is on, it will automatically reduce the set regular baking temperature by 13.9°C (25°F) to the appropriate convection

temperature in convection bake mode. See *Auto Recipe™ Conversion in the Special Features* section.

To change the oven temperature, touch the CONVECTION BAKE or CONVECTION ROAST pad and then the number pads to set the new temperature.

When the oven starts to heat, the changing temperature, starting at 37.8°C (100°F), will be displayed. When oven reaches the temperature you set, 3 beeps will sound.

4 Touch CLEAR/OFF pad when finished.

- You will hear a fan while cooking with convection. The fan will stop when the door is opened, but the heat will not turn off.

- You may hear the oven clicking during baking. This is normal.

- In convection bake modes, for maximum cooking evenness, the fan is designed to rotate in both directions, with a pause in between. This is normal.

Cookware for Convection Cooking

When baking cookies, you will get the best results if you use a flat cookie sheet instead of a pan with low sides.

Before using your convection oven, check to see if your cookware leaves room for air circulation in the oven. If you are baking with several pans, leave space between them. Also, be sure the pans do not touch each other or the walls of the oven.

Paper and Plastic

Heat-resistant paper and plastic containers that are recommended for use in regular baking can also be used for convection baking but should not be used at temperatures higher than the temperature recommended by the cookware manufacturer. Plastic cookware that is heat-resistant to temperatures of 204.4°C (400°F) can also be used.

Metal and Glass

Any type of cookware will work in your convection oven; however, metal pans heat the fastest and are recommended for convection baking.

- Darkened or matte-finished pans will bake faster than shiny pans.

- Glass or ceramic pans cook more slowly.

For recipes like oven-baked chicken, use a pan with low sides. Hot air cannot circulate well around food in a pan with high sides.

Using the timed features for convection cooking. *(on some models)*

You will hear a fan while cooking with these features. The fan will stop when the door is opened, but the heat will not turn off.

NOTE: *Foods that spoil easily—such as milk, eggs, fish, stuffings, poultry and pork—should not be allowed to sit for more than 1 hour before or after cooking. Room temperature promotes the growth of harmful bacteria. Be sure that the oven light is off because heat from the bulb will speed harmful bacteria growth.*

Convection
Auto recipe conversion

Bake
Cuire

Roast
Rôtir

Conversion de recettes

How to Set an Immediate Start and Automatic Stop

Press desired convection function. Proceed to step 2 of *How to Set an Immediate Start and Automatic Stop* in *Using the timed baking and roasting features* section.

Convection
Auto recipe conversion

Bake
Cuire

Roast
Rôtir

Conversion de recettes

How to Set a Delayed Start and Automatic Stop

Press desired convection function. Proceed to step 2 of *How to Set a Delay Start and Automatic Stop* in *Using the timed baking and roasting features* section.

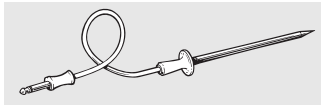

For best results when roasting large turkeys and roasts, we recommend using the probe included in the convection oven.

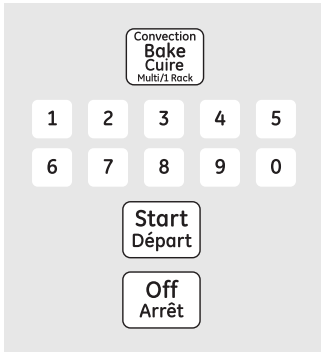

To change the oven temperature during the Convection Roast cycle, touch the CONVECTION BAKE pad and then touch the number pads to set the new desired temperature.

How to Set the Oven for Convection Roasting when Using the Probe

⚠ CAUTION

To prevent burns, do not unplug the probe from the oven outlet until the oven has cooled.

- 1 Place the oven rack in the position that centers the food between the top and bottom of the oven. Insert the probe into the meat. Make sure it is pushed all the way in.
- 2 Plug the probe into the outlet in the oven. Make sure it is pushed all the way in. Close the oven door.
- 3 Touch the PROBE pad.
- 4 Touch the number pads to set the desired internal meat temperature.

NOTE: The maximum internal temperature for the food that you can set is 93.3°C (200°F).

- 5 Touch the CONVECTION BAKE pad.
- 6 Touch the number pads to set the desired oven temperature.

The display will flash PROBE and the oven control will signal if the probe is inserted into the outlet, and you have not set a probe temperature and pressed the START pad.

- 7 Touch the START pad.

When the oven starts to heat, the word LO will be in the display.

Convection Roasting Guide

	Meat		Oven Temp.	Internal Temp.
Beef	Rib Roast (1.8 kg to 3.6 kg/4 to 8 lbs.) Bone-In and Boneless	Rare	162.8°C (325°F)	62.8°C (145°F)
		Medium	162.8°C (325°F)	71.1°C (160°F)
	Beef Tenderloin (1.8 kg to 2.7 kg/4 to 6 lbs.) Beef Tenderloin (0.9 kg to 1.4 kg/2 to 3 lbs.)	Rare	218.3°C (425°F)	62.8°C (145°F)
		Rare	218.3°C (425°F)	62.8°C (145°F)
Pork	Bone-In, Boneless (1.4 kg to 2.3 kg/3 to 5 lbs.)		162.8°C (325°F)	71.1°C (160°F)
Lamb	Bone-In, Boneless (2.3 kg to 4 kg/5 to 9 lbs.) Boneless (1.8 kg to 3.2 kg/4 to 7 lbs.)	Medium	162.8°C (325°F)	73.9°C (165°F)
		Medium	190.6°C (375°F)	73.9°C (165°F)
Poultry	Whole Chicken (2.3 kg to 3.2 kg/5 to 7 lbs.)		176.7°C (355°F)	76.7°C (170°F)
	Turkey, Whole* Unstuffed (4.5 kg to 7.4 kg/10 to 16 lbs.) Unstuffed (8.2 kg to 10.9 kg/18 to 24 lbs.)		162.8°C (325°F)	76.7-82.2°C (170°-180°F)
			162.8°C (325°F)	76.7-82.2°C (170°-180°F)
	Turkey Breast (1.8 kg to 2.7 kg/4 to 6 lbs.)		162.8°C (325°F)	76.7°C (170°F)

* Stuffed birds generally require 30–45 minutes additional roasting time. Shield legs and breast with foil to prevent overbrowning and drying of skin.

Using the self-cleaning oven.

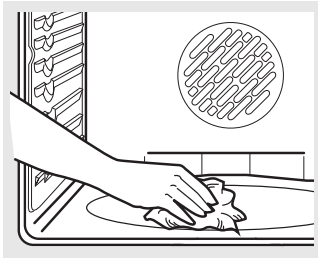

Wipe up heavy soil on the oven bottom.

Before a Clean Cycle

⚠ WARNING

FIRE HAZARD: Wipe grease and heavy soil from the oven bottom before self-cleaning. Failure to do so may result in an oven fire.

We recommend venting your kitchen with an open window or using a ventilation fan or hood during the first self-clean cycle.

Remove any broiler pan, broiler grid, probe, all cookware and any aluminum foil from the oven.

NOTE:

- If your oven is equipped with shiny, silver-colored oven racks, remove them before you begin the self-clean cycle.
- The shiny, silver-colored oven racks (on some models) can be self-cleaned, but they will darken, lose their luster and become hard to slide.
- If your oven is equipped with gray porcelain-coated oven racks, they may be left in the oven during the self-clean cycle.

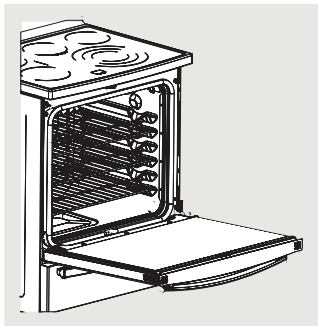

Gently wipe off glass inner door with hot, soapy water and a sponge or soft cloth. Never use fiber, abrasive cleaners or ammonia based products.

Soil on the front frame of the range and outside the gasket on the door will need to be cleaned by hand. Clean these areas with hot water, soap-filled steel-wool pads or cleansers such as Soft Scrub®. Rinse well with clean water and dry.

Do not clean the gasket. The fiberglass material of the oven door gasket cannot withstand abrasion. It is essential for the gasket to remain intact. If you notice it becoming worn or frayed, replace it.

Make sure the oven light bulb cover is in place and the oven light is off.

IMPORTANT: The health of some birds is extremely sensitive to the fumes given off during the self-cleaning cycle of any range. Move birds to another well-ventilated room.

- Remove any excessive spillovers in the oven cavity before starting the Self-Cleaning cycle. To clean use hot, soapy water and a cloth. Large spillovers can use heavy smoke or fire when subjected to high temperatures. **DO NOT** allow food spills with a high sugar or acid content (such as milk, tomatoes, sauerkraut, fruit, juices or pie filling) to remain on the surface as they may leave a dull spot even after cleaning.

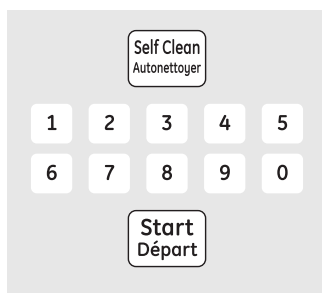

How to Set the Oven for Cleaning

The oven doors must be closed and all controls set correctly for the cycle to work properly.

- 1** Touch the SELF CLEAN pad.
A 3-hour self-clean time is recommended for use when cleaning small, contained spills. A self-clean time of 5 hours is recommended for a dirtier oven.
- 2** If a time other than 5 hours or 3 hours is needed, use the number pads and enter the desired clean time.



You can change the clean time to any time between 3 hours and 5 hours, depending on how dirty your oven is.

- 3** Touch the START pad.

The oven door locks automatically. The cooktop elements are also locked out during self-clean. The display will show the clean time remaining.

It will not be possible to open the oven doors or use the cooktop until the temperature drops below the lock temperature and LOCKED/DOOR  goes off in the control display.

When LOCKED/DOOR  goes off, you will be able to open the doors.

- The word LOCKED/DOOR  will flash and the word door will display if you set the clean cycle and forget to close the oven doors.
- To stop a clean cycle, touch the OFF pad. When LOCKED/DOOR  goes off, indicating the ovens have cooled below the locking temperature, you will be able to open the doors.
- When the oven is set to self-clean, oven will lock and the cooktop controls will lock out. The oven and cooktop cannot be used when it is set to self-clean.

Using the self-cleaning oven.

www.GEAppliances.ca

The oven doors must be closed and all controls set correctly for the cycle to work properly.



How to Delay the Start of Cleaning

- 1 Touch the SELF CLEAN pad.
A 3-hour self-clean time is recommended for use when cleaning small, contained spills. A self-clean time of 5 hours is recommended for a dirtier oven.
- 2 If a time other than 5 hours or 3 hours is needed, use the number pads and enter the desired clean time.
You can change the clean time to any time between 3 hours and 5 hours, depending on how dirty your oven is.
- 3 Touch the DELAY START pad.
- 4 Using the number pads, enter the time of day you want the clean cycle to start.

- 5 Touch the START pad.

The door lock automatically. The cooktop elements are also locked out during self-clean. The display will show the start time. It will not be possible to open the oven door or use the cooktop until the temperature drops below the lock temperature and LOCKED/DOOR  goes off in the control display.

When LOCKED/DOOR  goes off, you will be able to open the door.

After a Clean Cycle

You may notice some white ash in the oven. Wipe it up with a damp cloth after the oven cools.

If white spots remain, remove them with a soap-filled steel wool pad and rinse thoroughly with a vinegar and water mixture.

These deposits are usually a salt residue that cannot be removed by the clean cycle.

If the oven is not clean after one clean cycle, repeat the cycle.

- You cannot set the oven for cooking or another self-clean cycle until the oven is cool enough for the door to unlock.
- While the oven is self-cleaning, you can touch the CLOCK pad to display the time of day. To return to the clean countdown, touch the SELF CLEAN pad.
- If the racks become hard to slide, apply a small amount of cooking oil to a paper towel and wipe the edges of the oven racks with the paper towel.

Special features of your oven control.

Your new touch pad control has additional features that you may choose to use. The following are the features and how you may activate them.

The special feature modes can only be activated while the display is showing the time of day. They remain in the control's memory until the steps are repeated.

When the display shows your choice, touch the **START** pad. The special features will remain in memory after a power failure, except for the Sabbath feature, which will have to be reset.

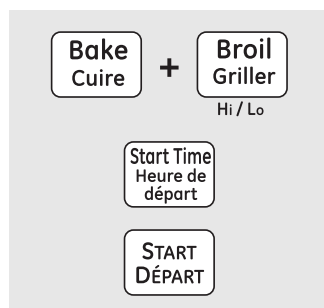

12-Hour Shutdown

With this feature, should you forget and leave the oven on, the control will automatically turn off the oven after 12 hours during baking functions or after 3 hours during a broil function.

If you wish to turn OFF this feature, follow the steps below.

- 1 Touch the upper oven **BROIL HI/LO** and **BAKE** pads at the same time until the display shows SF.

- 2 Touch the **START TIME** pad until no shdn (no shut-off) appears in the display.
- 3 Touch the **START** pad to activate the no shut-off and leave the control set in this special features mode.

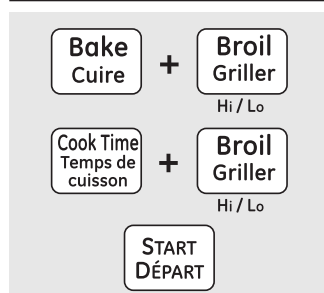

Fahrenheit or Celsius Temperature Selection

Your oven control is set to use the Fahrenheit temperature selections, but you may change this to use the Celsius selections.

- 1 Touch the upper oven **BROIL HI/LO** and **BAKE** pads at the same time until the display shows SF.

- 2 Touch the **COOK TIME** and **BROIL HI/LO** pads at the same time. The display will show F (Fahrenheit).
- 3 Touch the **COOK TIME** and **BROIL HI/LO** pads again at the same time. The display will show C (Celsius).
- 4 Touch the **START** pad.

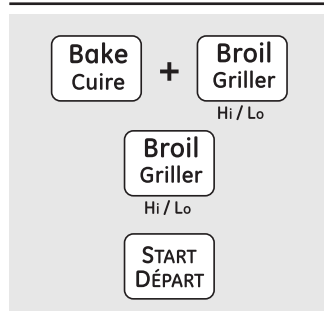

(on some models)

Tones at the End of a Timed Cycle

At the end of a timed cycle, 3 short beeps will sound followed by one beep every 6 seconds until the **CLEAR/OFF** pad is touched. This continual 6-second beep may be cancelled.

To cancel the 6-second beep:

- 1 Touch the upper oven **BROIL HI/LO** and **BAKE** pads at the same time until the display shows SF.
- 2 Touch the **BROIL HI/LO** pad. The display shows CONTI BEEP (continuous beep). Touch the **BROIL HI/LO** pad again. The display shows SINGLE BEEP. (This cancels the one beep every 6 seconds.)

OR

Touch the **TIMER ON/OFF** pad. The display shows CON BEEP (continual beep). Touch the **TIMER ON/OFF** pad again. The display shows BEEP. (This cancels the one beep every 6 seconds.)

- 3 Touch the **START** pad.

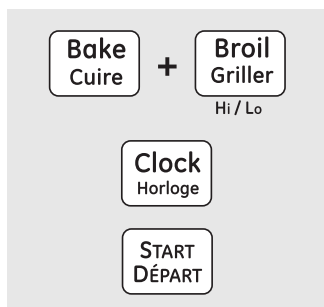

12-Hour, 24-Hour or Clock Blackout

Your control is set to use a 12-hour clock.

If you would prefer to have a 24-hour military time clock or black out the clock display, follow the steps below.

- 1 Touch the upper oven BROIL HI/LO and BAKE pads at the same time until the display shows SF.
- 2 Touch the CLOCK pad once. The display will show 12 hr. If this is the choice you want, touch the START pad.

Touch the CLOCK pad again to change to the 24-hour military time clock. The display will show 24 hr. If this is the choice you want, touch the START pad.

Touch the CLOCK pad again to black out the clock display. The display will show OFF. If this is the choice you want, touch the START pad.

NOTE: If the clock is in the black-out mode, you will not be able to use the Delay Start function.

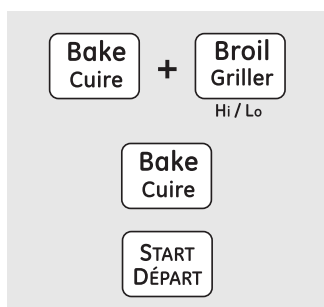

Auto Recipe™ Conversion (on some models)

When using convection bake, the Auto Recipe™ Conversion feature will automatically convert entered regular baking temperatures to convection baking temperatures.

This feature is activated so that the display will show the actual converted (reduced) temperature. For example, if you enter a regular recipe temperature of 176.7°C (350°F) and touch the START pad, the display will show CON and the converted temperature of 162.8°C (325°F).

To deactivate the feature:

- 1 Touch the upper oven BAKE and BROIL HI/LO pads at the same time until the display shows SF.
- 2 Touch the CONVECTION BAKE pad. The display will show CON ON. Touch the CONVECTION BAKE pad again. The display will show CON OFF.
- 3 Touch the START pad.

To reactivate the feature, repeat steps 1–3 above but touch the START pad when CON ON is in the display.

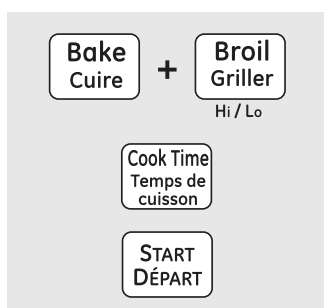

Cook and Hold (on some models)

Your new control has a cook-and-hold feature that keeps cooked foods warm for up to 3 hours after the cooking function is finished.

To activate this feature, follow the steps below.

- 1 Touch the BAKE and BROIL HI/LO pads at the same time until the display shows SF.

- 2 Touch the COOK TIME pad. The display will show Hld OFF.

Touch the COOK TIME pad again to activate the feature. The display will show Hld ON.

- 3 Touch the START pad to activate the cook-and-hold feature and leave the control set in this special features mode.

Using the Sabbath feature. *(upper and lower ovens)*

(Designed for use on the Jewish Sabbath and Holidays) (on some models)

The Sabbath feature can be used for baking/roasting only. It cannot be used for convection, broiling, self-cleaning or Delay Start cooking.

NOTE: The oven light comes on automatically (on some models) when the door is opened and goes off when the door is closed. The bulb may be removed. See the Oven Light Replacement section. On models with a light switch on the control panel, the oven light may be turned on and left on.

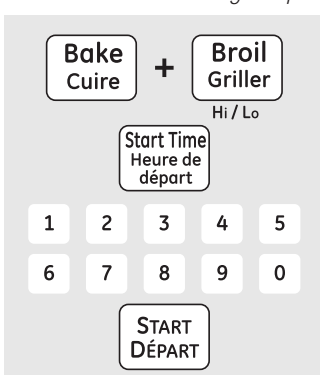

When the display shows \square , the oven is set in Sabbath. When the display shows $\square \square$, the oven is baking/roasting.

How to Set for Regular Baking/Roasting

Make sure the clock shows the correct time of day and the oven is off.

- 1 Touch and hold both the upper oven BROIL HI/LO and BAKE pads, at the same time, until the display shows SF.

NOTE: If bake or broil appears in the display, the BROIL HI/LO and BAKE pads were not touched at the same time. Touch the CLEAR/OFF pad and begin again.

- 2 Tap the START TIME pad until SAb bAtH appears in the display.
- 3 Touch the START pad and \square will appear in the display. Both ovens are now in Sabbath mode.
- 4 Touch the BAKE pad on the upper or lower oven. No signal will be given.

- 5 Using the number pads, enter the desired temperature between 76.7°C (170°F) and 287.8°C (550°F). No signal or temperature will be given. There is no default temperature.

- 6 Touch the START pad on the corresponding oven.

- 7 After a random delay period of approximately 30 seconds to 1 minute, $\square \square$ will appear in the display indicating that the oven is baking/roasting. If $\square \square$ doesn't appear in the display, start again at Step 4.

- 8 To bake in the other oven, start at Step 4 (on some models).

To adjust the oven temperature, touch the BAKE pad, enter the new temperature using the number pads and touch the START pad.

NOTE: The CLEAR/OFF and COOK TIME pads are active during the Sabbath feature.

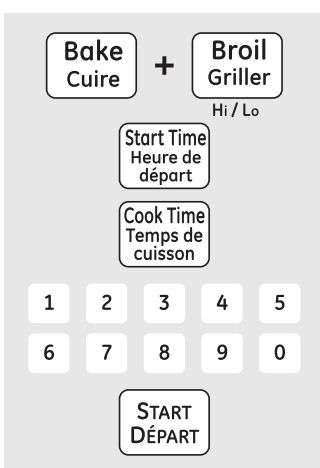

When the display shows \square , the oven is set in Sabbath. When the display shows $\square \square$, the oven is baking/roasting.

How to Set for Timed Baking/Roasting—Immediate Start and Automatic Stop

Make sure the clock shows the correct time of day and the oven is off.

- 1 Touch and hold both the upper oven BROIL HI/LO and BAKE pads, at the same time, until the display shows SF.

NOTE: If bake or broil appears in the display, the BROIL HI/LO and BAKE pads were not touched at the same time. Touch the CLEAR/OFF pad and begin again.

- 2 Tap the START TIME pad until SAb bAtH appears in the display.
- 3 Touch the START pad and \square will appear in the display. Both ovens are now in Sabbath mode.
- 4 Touch the COOK TIME pad on the upper or lower oven. No signal will be given.
- 5 Touch the number pads to set the desired length of cooking time between 1 minute and 9 hours and 99 minutes.
- 6 Touch the START pad.

- 7 Touch the BAKE pad. No signal will be given.

- 8 Using the number pads, enter the desired temperature. No signal or temperature will be given. There is no default temperature.

- 9 Touch the START pad on the corresponding oven.

- 10 After a random delay period of approximately 30 seconds to 1 minute, $\square \square$ will appear in the display indicating that the oven is baking/roasting. If $\square \square$ doesn't appear in the display, start again at Step 7.

To adjust the oven temperature, touch the BAKE pad, enter the new temperature using the number pads and touch the START pad.

When cooking is finished, the display will change from $\square \square$ to \square and 0:00 will appear, indicating that the oven has turned OFF but is still set in Sabbath. Remove the cooked food.

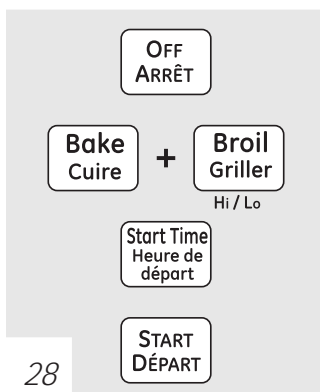

How to Exit the Sabbath Feature

- 1 Touch the CLEAR/OFF pad.
- 2 If the oven is cooking, wait for a random delay period of approximately 30 seconds to 1 minute, until only \square is in the display.
- 3 Touch and hold both the BROIL HI/LO and BAKE pads, at the same time, until the display shows SF.
- 4 Tap the START TIME pad until 12 shdn or no shdn appears in the display.

- 5 Choose 12 shdn, indicating that the oven will automatically turn off after 12 hours or no shdn, indicating that the oven will not automatically turn off after 12 hours.

- 6 Press START when the option that you want is in the display (12 shdn or no shdn).

NOTE: If a power outage occurred while the oven was in Sabbath, the oven will automatically turn off and stay off even when the power returns. The oven control must be reset. Some models will resume Sabbath mode; however, opening the door will activate the oven light

Using the warming drawer. *(on some models)*

⚠ WARNING

FOOD POISON HAZARD: Bacteria may grow in food at temperatures below 60°C (140°F).

- Always start with hot food. Do not use warm settings to heat cold food.
- Do not warm food for more than 2 hours.

Failure to follow these instructions may result in foodborne illness.

The warming drawer will keep hot, cooked foods at serving temperature. Always start with hot food. Do not use to heat cold food other than crisping crackers, chips or dry cereal.



To Use the Warming Drawer

Touch the WARMING DRAWER pad. "WARMER ON" and "1" are lit on the display and "Set" begins to blink. On the number pads, touch 1 for Low, 2 for Medium or 3 for High. The display "1" changes corresponding to the number pad selected. The warming drawer starts automatically after you touch 1, 2 or 3. "WARMER ON" and the number remain lit. "Set" stops blinking. On some models press START.

On some models there are just 2 levels, 1 for low and 2 for High.

To cancel, touch the WARMING DRAWER pad.

NOTE: Touching the CLEAR/OFF pad does not turn off the warming drawer.

When Using the Warming Drawer

The warming drawer will keep hot, cooked foods warm. Always start with hot food. Do not use to heat cold food other than crisping crackers, chips or dry cereal.

Do not line the warming drawer or pan with aluminum foil. Foil is an excellent heat insulator and will trap heat beneath it. This will upset the performance of the drawer and could damage the interior finish.

Allow approximately 25 minutes for the warming drawer to preheat.

- Do not put liquid or water in the warming drawer.

- All foods placed in the warming drawer should be covered with a lid or aluminum foil. When warming pastries or breads, the cover should be vented to allow moisture to escape.

- Food should be kept hot in its cooking container or transferred to a heat-safe serving dish.

NOTE: *Plastic containers or plastic wrap will melt if in direct contact with the drawer, pan or a hot utensil. Melted plastic may not be removable and is not covered under your warranty.*

- Remove serving spoons, etc., before placing containers in warming drawer.

Temperature Selection Chart

To keep several different foods hot, set the control to the food needing the highest setting.

- The temperature, type and amount of food, and the time held will affect the quality of the food.
- Repeated opening of the drawer allows the hot air to escape and the food to cool.
- With large loads it may be necessary to use a higher warming drawer setting and cover some of the cooked food items.

- Do not use plastic containers or plastic wrap.

Food Type	Control Setting
Casserole	MED/2
Chili	HI/3
Pizza	MED/2
Potatoes, baked	HI/3
Tortilla Chips	LO/1
Waffles	LO/1

To Crisp Stale Items

- Place food in low-sided dishes or pans.
- Preheat on LO/1 setting.
- Check crispness after 45 minutes. Add time as needed.

To Warm Serving Bowls and Plates

⚠ CAUTION

Dishes will be hot. Use pot holders or mitts when removing hot dishes.

To warm serving bowls and plates, set the control on LO/1.

- Use only heat-safe dishes.
- If you want to heat fine china, please check with the manufacturer of the dishes for their maximum heat tolerance.
- You may warm empty serving dishes while preheating the drawer.

Using the lower oven drawer. *(on some models)*

The lower oven drawer may be used to bake foods using the same times and temperatures as a standard oven. Foods ideal for baking in the lower oven drawer include pizza, frozen foods, casseroles, biscuits, rolls and many desserts.

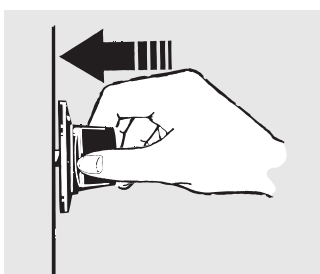
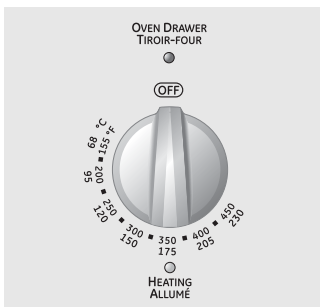

Push in and turn the lower oven drawer knob to any desired setting.

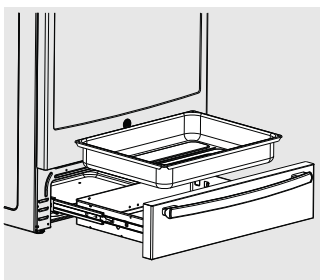

To Use the Lower Oven Drawer

- 1 Push in and turn the lower oven drawer knob to any desired setting.
- 2 Allow the lower oven drawer to preheat.
 - The ON signal light is located above the knob and glows when the knob is in the ON position. It remains ON until the knob is moved to the OFF position.
 - The "Heating" signal light is located below the knob and glows when the heating elements are active. Preheat is complete after the "Heating" signal has turned off for the first time after the knob is turned on.

NOTES:

- Always use the included drawer rack when using the lower oven drawer.
- The lower oven drawer cannot be used during a self-clean cycle of the upper oven.
- Do not put food, foil or cookware directly on the bottom of the lower oven drawer. Always use the included drawer rack.
- If foods require a cover, use only foil or lids able to withstand baking temperatures. Do not use plastic.
- Maximum height of foods that can be baked in the lower oven drawer is 8.9 cm (3 1/2").
- Do not put liquid or water in the lower oven drawer.
- Never place plastics, paper, canned foods or combustible material in the lower oven drawer.

The lower oven drawer uses less energy than the upper oven. Allow the following approximate times for preheating:

Desired Lower Oven Temperature	Preheat Time
WARM	10 minutes
176.7°C (350°F)	15 minutes
218.3°C (425°F)	25 minutes

When Using the Lower Oven Drawer Warm Setting

The WARM SETTING of the lower oven drawer can be used to keep hot, cooked foods at serving temperatures. Always start with hot food. Do not use the WARM SETTING to heat cold food other than crisping crackers, chips or dry cereal.

Push in and turn the control knob to the warm setting.

NOTE: The beginning temperature of the food, the amount of food, the type of food, the container and the amount of time the food is in the drawer will affect the quality and ending temperature of the food.

Care and cleaning of the range.

www.GEAppliances.ca

Be sure all controls are off and all surfaces are cool before cleaning any part of the range.

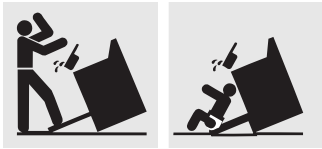

⚠ WARNING

If your range is removed for cleaning, servicing or any reason, be sure the anti-tip device is reengaged properly when the range is replaced. Failure to take this precaution could result in tipping of the range and cause injury.

How to Remove Protective Shipping Film and Packaging Tape

Carefully grasp a corner of the protective shipping film with your fingers and slowly peel it from the appliance surface. Do not use any sharp items to remove the film. Remove all of the film before using the appliance for the first time.

To ensure no damage is done to the finish of the product, the safest way to remove the adhesive from packaging tape on new appliances is an application of a household liquid dishwashing detergent. Apply with a soft cloth and allow to soak.

NOTE: The adhesive must be removed from all parts. It cannot be removed if it is baked on.

Control Knobs

The control knobs may be removed for easier cleaning.

Make sure the knobs are in the **OFF** positions and pull them straight off the stems for cleaning.

The knobs can be cleaned in a dishwasher or they may also be washed with soap and water. Make sure the inside of the knobs are dry before replacing.

Replace the knobs, in the **OFF** position to ensure proper placement.

Control Panel

If desired, the touch pads may be deactivated before cleaning.

See the **Control Lockout** information in the *Using the clock, kitchen timer and control lockout* section in this manual.

Clean up splatters with a damp cloth.

You may also use a glass cleaner.

Remove heavier soil with warm, soapy water. Do not use abrasives of any kind.

Reactivate the touch pads after cleaning.

Painted Surfaces

Painted surfaces include the sides of the range and the door, top of control panel and the drawer front. Clean these with soap and water or a vinegar and water solution.

Do not use commercial oven cleaners, cleaning powders, steel wool or harsh abrasives on any painted surface.

Stainless Steel Surfaces (on some models)

Do not use a steel wool pad; it will scratch the surface.

To clean the stainless steel surface, use warm, sudsy water or a stainless steel cleaner or polish. Always wipe the surface in the direction of the grain. Follow the cleaner instructions for cleaning the stainless steel surface.

To inquire about purchasing stainless steel appliance cleaner or polish or to find the location of a dealer nearest you, please call our toll-free number:

National Parts Centre 1.800.661.1616
www.GEAppliances.ca

Porcelain Enamel Cooktop (on some models)

The porcelain enamel finish is sturdy but breakable if misused. This finish is acid-resistant. However, any acidic foods spilled (such as fruit juices, tomato or vinegar) should not be permitted to remain on the finish.

If acids spill on the cooktop while it is hot, use a dry paper towel or cloth to wipe it up

right away. When the surface has cooled, wash with soap and water. Rinse well.

For other spills such as fat splatterings, wash with soap and water or cleansing powders after the surface has cooled. Rinse well. Polish with a dry cloth.

Safety Instructions

Operating Instructions

Care and Cleaning

Troubleshooting Tips

Consumer Support

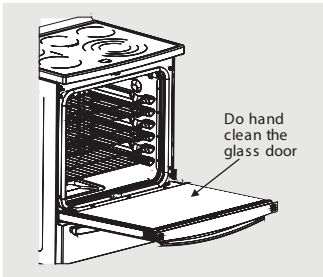

Do not rub or clean the oven gasket—it has an extremely low resistance to abrasion.

If you notice the gasket becoming worn, frayed or damaged in any way you should have it replaced.

Cleaning the Oven Door

To clean the inside of the door:

- Gently wipe off glass inner door with hot, soapy water and a sponge or soft cloth. Never use fiber, abrasive cleaners or ammonia based products.

To clean the outside of the door:

- Use soap and water to thoroughly clean the top, sides and front of the oven door. Rinse well. You may also use a glass cleaner to clean the glass on the outside of the door. Do not let water drip into the vent openings.

- If any stain on the door vent trim is persistent, use a soft abrasive cleaner and a sponge-scrubber for best results.
- Spillage of marinades, fruit juices, tomato sauces and basting materials containing acids may cause discoloration and should be wiped up immediately. When surface is cool, clean and rinse.
- Do not use oven cleaners, cleaning powders or harsh abrasives on the outside of the door.

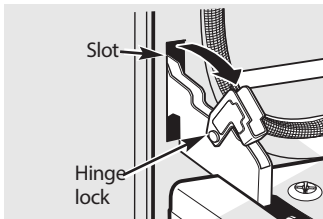

Pull hinge locks down to unlock.

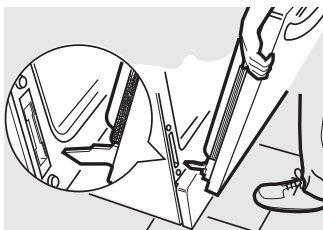

Removal position

Lift-Off Oven Door *(on some models)*

The door is very heavy. Be careful when removing and lifting the door.

Do not lift the door by the handle.

To remove the door:

- 1 Fully open the door.
- 2 Pull the hinge locks down toward the door frame, to the unlocked position. A tool, such as a small flat-blade screwdriver, may be required.
- 3 Firmly grasp both sides of the door at the top.
- 4 Close door to the door removal position, which is halfway between the broil stop position and fully closed.
- 5 Lift door up and out until the hinge arm is clear of the slot.

To replace the door:

- 1 Firmly grasp both sides of the door at the top.

- 2 With the door at the same angle as the removal position, seat the indentation of the hinge arm into the bottom edge of the hinge slot. The notch in the hinge arm must be fully seated into the bottom of the slot.

- 3 Fully open the door. If the door will not fully open, the indentation is not seated correctly in the bottom edge of the slot.

- 4 Push the hinge locks up against the front frame of the oven cavity to the locked position.

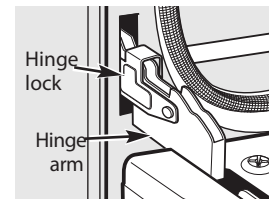

Push hinge locks up to lock.

- 5 Close the oven door.

Oven Racks

All oven racks may be cleaned by hand with an abrasive cleaner or steel wool. After cleaning, rinse the racks with clean water and dry with a clean cloth. Gray porcelain-coated oven racks may remain in the oven during the self-cleaning cycle without being damaged. The nickel-plated oven racks may remain in the oven during the

self-cleaning cycle, but they will lose their luster and become hard to slide. It will be necessary to grease all oven rack side edges with a light coating of vegetable oil after cleaning them by hand or in the oven. This will help maintain the ease of sliding the racks in and out of the oven.

Safety Instructions

Operating Instructions

Care and Cleaning

Troubleshooting Tips

Consumer Support

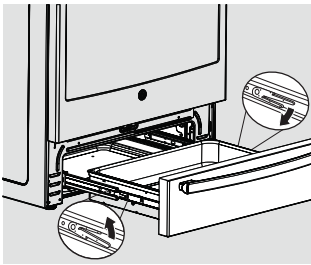

Removable Drawer (Warming Drawer Models only)

NOTE: For models with an electric warming drawer, before performing any adjustments, cleaning or service, disconnect the range electrical power supply at the household distribution panel by removing the fuse or switching off the circuit breaker. Make sure the warming drawer heating element is cool.

To replace the drawer:

- 1 Place the left drawer rail around the inner left rail guide and slide it in slightly to hook it.
- 2 Place the right drawer rail around the inner right rail guide and slide it in slightly to hook it.
- 3 Slide the drawer all the way in.

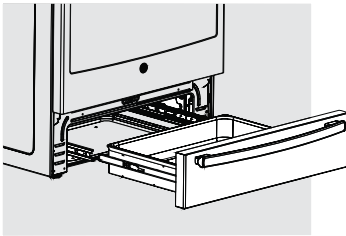

Most cleaning can be done with the drawer in place. However, the drawer may be removed if further cleaning is needed. Use soap and warm water to clean thoroughly.

To remove the drawer:

- 1 Pull the drawer straight out until it stops.
- 2 Press the left rail release up and press the right rail release down, while pulling the drawer forward and free.

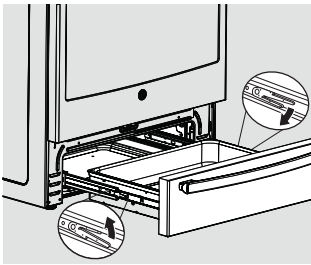

Removable Drawer (Lower Oven Drawer Models only)

NOTE: For models with an electric warming drawer or lower oven drawer, before performing any adjustments, cleaning or service, disconnect the range electrical power supply at the household distribution panel by removing the fuse or switching off the circuit breaker. Make sure the warming drawer heating element is cool.

To replace the drawer:

- 1 Place the left drawer rail around the inner left rail guide and slide it in slightly to hook it.
- 2 Place the right drawer rail around the inner right rail guide and slide it in slightly to hook it.
- 3 Slide the drawer all the way in.

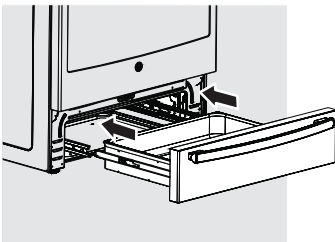

Most cleaning can be done with the drawer in place. However, the drawer may be removed if further cleaning is needed. Use soap and warm water to clean thoroughly.

To remove the drawer:

- 1 Pull the drawer straight out until it stops.
- 2 Press the tabs on both sides in while pulling the drawer forward and free.

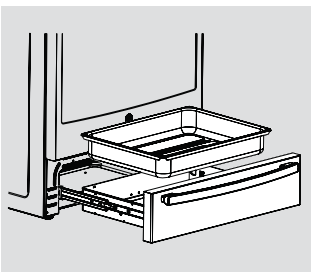

Removable Lower Oven Drawer Pan

NOTE: For models with an electric warming drawer or lower oven drawer, before performing any adjustments, cleaning or service, disconnect the range electrical power supply at the household distribution panel by removing the fuse or switching off the circuit breaker. Make sure the drawer heating element is cool.

- Never place, use or self-clean the lower oven drawer pan in the upper oven.
- Lower oven drawer has a removable pan for easy cleaning. Clean with hot soapy water and a sponge or dish towel. Dry with a clean cloth. An oven cleaner, such as Easy-Off[®], may also be used. Be sure to follow the directions on the oven cleaner. Replace the pan in the lower oven drawer.

NOTE: Allow lower oven drawer to cool before removing pan.

NOTE: Wipe spills promptly after each use.

⚠ WARNING

SHOCK OR BURN HAZARD: Before replacing oven light bulb, disconnect the electrical power to the range at the main fuse or circuit breaker panel. Failure to do so may result in electric shock or burn.

⚠ CAUTION

BURN HAZARD: The glass cover and bulb should be removed when cool. Touching hot glass with bare hands or a damp cloth can cause burns.

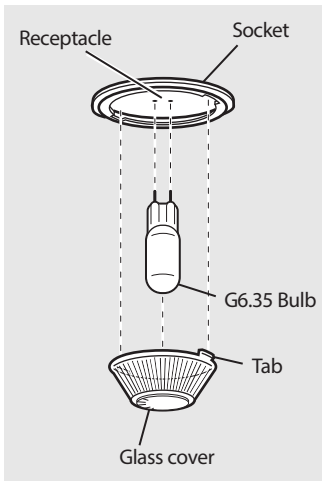

(on some models)

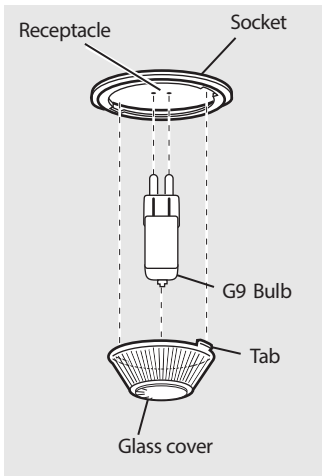

(on some models)

Oven Light Replacement

To remove:

- 1 Turn the glass cover counterclockwise 1/4 turn until the tabs of the glass cover clear the grooves of the socket. Wearing latex gloves may offer a better grip.
- 2 Using gloves or a dry cloth, remove the bulb by pulling it straight out.

To replace:

- 1 Use a new 120/130-volt halogen bulb, not to exceed 50 watts. Replace the bulb with the same type of bulb that was removed. Your model will have one of the two types shown on the left. To determine the correct replacement bulb, check the bulb terminals. Bulbs with 2 straight pin terminals are G6.35 bulbs. Bulbs with 2 looped terminals are G9 bulbs. (Do not interchange.) Be sure the replacement bulb is rated 120 volts or 130 volts (NOT 12 volts).
- 2 Using gloves or a dry cloth, remove the bulb from its packaging. Do not touch the bulb with bare fingers. Oil from skin will damage the bulb and shorten its life.

Some models are provided with 2 lights, one at oven top and other at oven back.

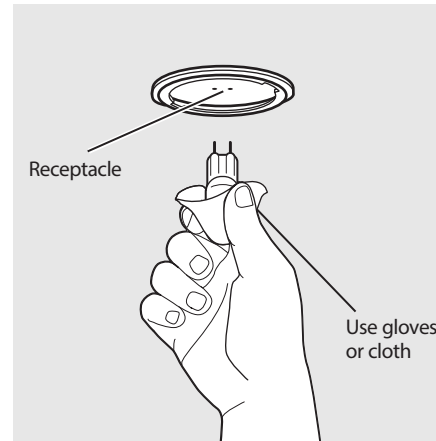

- 3 Push the bulb straight into the receptacle all the way.
- 4 Place the tabs of the glass cover into the grooves of the socket. Turn the glass cover clockwise 1/4 turn.

For improved lighting inside the oven, clean the glass cover frequently using a wet cloth. This should be done when the oven is completely cool.
- 5 Reconnect electrical power to the oven.

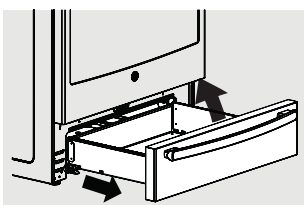

The storage drawer may be removed for cleaning under the range.

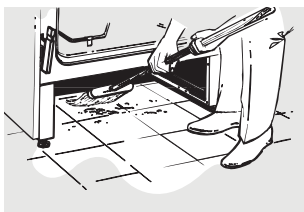

Removable Storage Drawer (on some models)

The storage drawer is a good place to store cookware and bakeware. Do not store plastics and flammable material in the drawer.

The storage drawer may be removed for cleaning under the range. Clean the storage drawer with a damp cloth or sponge. Never use harsh abrasives or scouring pads.

To remove storage drawer:

- 1 Pull drawer straight out until it stops.
- 2 Tilt the front of the drawer up and free of the range.

To replace storage drawer:

- 1 Set the stops on the back of the drawer over the stops in the range.
- 2 Slide drawer evenly and straight back, so that the rails in the range are engaged.

Cleaning the glass cooktop. *(on some models)*



Clean your cooktop after each spill. Use CERAMA BRYTE® Ceramic Cooktop Cleaner.

Normal Daily Use Cleaning

ONLY use CERAMA BRYTE® Ceramic Cooktop Cleaner on the glass cooktop. Other creams may not be as effective.

To maintain and protect the surface of your glass cooktop, follow these steps:

- 1 Before using the cooktop for the first time, clean it with CERAMA BRYTE® Ceramic Cooktop Cleaner. This helps protect the top and makes cleanup easier.
- 2 Daily use of CERAMA BRYTE® Ceramic Cooktop Cleaner will help keep the cooktop looking new.

3 Shake the cleaning cream well. Apply a few drops of CERAMA BRYTE® Ceramic Cooktop Cleaner directly to the cooktop.

4 Use a paper towel or CERAMA BRYTE® Cleaning Pad for Ceramic Cooktops to clean the entire cooktop surface.

5 Use a dry cloth or paper towel to remove all cleaning residue. No need to rinse.

NOTE: It is very important that you DO NOT heat the cooktop until it has been cleaned thoroughly.

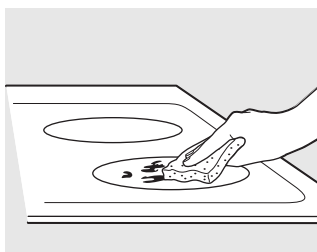

Use a CERAMA BRYTE Cleaning Pad for Ceramic Cooktops.

Burned-On Residue

NOTE: DAMAGE to your glass surface may occur if you use scrub pads other than those recommended.

- 1 Allow the cooktop to cool.
- 2 Spread a few drops of CERAMA BRYTE® Ceramic Cooktop Cleaner on the entire burned residue area.
- 3 Using the included CERAMA BRYTE® Cleaning Pad for Ceramic Cooktops, rub the residue area, applying pressure as needed.

4 If any residue remains, repeat the steps listed above as needed.

5 For additional protection, after all residue has been removed, polish the entire surface with CERAMA BRYTE® Ceramic Cooktop Cleaner and a paper towel.

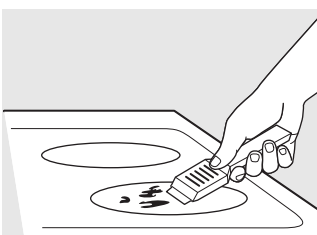

The CERAMA BRYTE Ceramic Cooktop Scraper and all recommended supplies are available through our Parts Centre. See instructions under "To Order Parts" section on next page.

NOTE: Do not use a dull or nicked blade.

Heavy, Burned-On Residue

- 1 Allow the cooktop to cool.
- 2 Use a single-edge razor blade scraper at approximately a 45° angle against the glass surface and scrape the soil. It will be necessary to apply pressure to the razor scraper in order to remove the residue.

3 After scraping with the razor scraper, spread a few drops of CERAMA BRYTE® Ceramic Cooktop Cleaner on the entire burned residue area. Use the CERAMA BRYTE® Cleaning Pad to remove any remaining residue.

4 For additional protection, after all residue has been removed, polish the entire surface with CERAMA BRYTE® Ceramic Cooktop Cleaner and a paper towel.

Metal Marks and Scratches

- 1 Be careful not to slide pots and pans across your cooktop. It will leave metal markings on the cooktop surface.

These marks are removable using the CERAMA BRYTE® Ceramic Cooktop Cleaner with the CERAMA BRYTE® Cleaning Pad for Ceramic Cooktops.

- 2 If pots with a thin overlay of aluminum or copper are allowed to boil dry, the overlay may leave black discoloration on the cooktop.

This should be removed immediately before heating again or the discoloration may be permanent.

NOTE: *Carefully check the bottom of pans for roughness that would scratch the cooktop.*

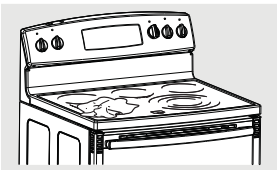

Cooktop Seal

To clean the cooktop seal around the edges of the glass, lay a wet cloth on it

for a few minutes, then wipe clean with nonabrasive cleaners.

Glass surface—potential for permanent damage.

Sugary spillovers (such as jellies, fudge, candy, syrups) or melted plastics can cause pitting of the surface of your cooktop (not covered by the warranty) unless the spill is removed while still hot. Special care should be taken when removing hot substances.

Be sure to use a new, sharp razor scraper.

Do not use a dull or nicked blade.

Damage from Sugary Spills and Melted Plastic

- 1 Turn off all surface units. Remove hot pans.
- 2 Wearing an oven mitt:
 - a. Use a single-edge razor blade scraper (CERAMA BRYTE® Ceramic Cooktop Scraper) to move the spill to a cool area on the cooktop.
 - b. Remove the spill with paper towels.

- 3 Any remaining spillover should be left until the surface of the cooktop has cooled.

- 4 Don't use the surface units again until all of the residue has been completely removed.

NOTE: *If pitting or indentation in the glass surface has already occurred, the cooktop glass will have to be replaced. In this case, service will be necessary.*



To Order Parts

To order CERAMA BRYTE® Ceramic Cooktop Cleaner and the cooktop scraper, please call our toll-free number:

National Parts Centre
800.661.1616

CERAMA BRYTE® Ceramic Cooktop Cleaner#WX10X300

CERAMA BRYTE® Ceramic Cooktop Scraper#WX10X0302

Kit#WB64X5027
(Kit includes cream and cooktop scraper)

CERAMA BRYTE® Cleaning Pads for Ceramic Cooktops#WX10X350

Before You Call For Service...



Troubleshooting Tips

Save time and money! Review the charts on the following pages first and you may not need to call for service.

Problem	Possible Causes	What To Do
Surface units will not maintain a rolling boil or cooking is not fast enough	Improper cookware being used.	<ul style="list-style-type: none"> Use pans which are flat and match the diameter of the surface unit selected.
	In some areas, the power (voltage) may be low.	<ul style="list-style-type: none"> Cover pan with a lid until desired heat is obtained.
Surface units do not work properly	A fuse in your home may be blown or the circuit breaker tripped.	<ul style="list-style-type: none"> Replace the fuse or reset the circuit breaker.
	Cooktop controls improperly set.	<ul style="list-style-type: none"> Check to see the correct control is set for the surface unit you are using.
Surface units do not work.	There has been a main power supply surge and/or a power interruption and surge.	<ul style="list-style-type: none"> On the Control Panel, activate the Self Clean mode (press the SELF CLEAN button). Wait for 30 seconds and then press the OFF button. The cooktop should now be ready to operate.
Surface unit stops glowing when turned to a lower setting	This is normal. The unit is still on and hot.	
Scratches (may appear as cracks) on cooktop glass surface	Incorrect cleaning methods being used.	<ul style="list-style-type: none"> Scratches are not removable. Tiny scratches will become less visible in time as a result of cleaning.
	Cookware with rough bottoms being used or coarse particles (salt or sand) were between the cookware and the surface of the cooktop.	<ul style="list-style-type: none"> To avoid scratches, use the recommended cleaning procedures. Make sure bottoms of cookware are clean before use, and use cookware with smooth bottoms.
	Cookware has been slid across the cooktop surface.	
Areas of discoloration on the cooktop	Food spillovers not cleaned before next use.	<ul style="list-style-type: none"> See the <i>Cleaning the glass cooktop</i> section.
	Hot surface on a model with a light-colored cooktop.	<ul style="list-style-type: none"> This is normal. The surface may appear discolored when it is hot. This is temporary and will disappear as the glass cools.
Plastic melted to the surface	Hot cooktop came into contact with plastic placed on the hot cooktop.	<ul style="list-style-type: none"> See the <i>Glass surface—potential for permanent damage</i> section in the <i>Cleaning the glass cooktop</i> section.
Pitting (or indentation) of the cooktop	Hot sugar mixture spilled on the cooktop.	<ul style="list-style-type: none"> Call a qualified technician for replacement.
Frequent cycling off and on of surface units	Improper cookware being used.	<ul style="list-style-type: none"> Use only flat cookware to minimize cycling.
Oven light does not work	Light bulb is loose.	<ul style="list-style-type: none"> Tighten or replace the bulb.
Oven will not work	Plug on range is not completely inserted in the electrical outlet.	<ul style="list-style-type: none"> Make sure electrical plug is plugged into a live, properly grounded outlet.
	A fuse in your home may be blown or the circuit breaker tripped.	<ul style="list-style-type: none"> Replace the fuse or reset the circuit breaker.
	Oven controls improperly set.	<ul style="list-style-type: none"> See the <i>Using the oven</i> section.
	Oven too hot.	<ul style="list-style-type: none"> Allow the oven to cool to below locking temperature.

<i>Problem</i>	<i>Possible Causes</i>	<i>What To Do</i>
<i>Food does not bake or roast properly</i>	Oven controls improperly set.	• See the <i>Using the oven</i> section.
	Rack position is incorrect or the rack is not level.	• See the <i>Using the oven</i> section.
	Incorrect cookware or cookware of improper size being used.	• See the <i>Using the oven</i> section.
	Oven thermostat needs adjustment.	• See the <i>Adjust the oven thermostat—Do it yourself!</i> section.
<i>Food does not broil properly</i>	Oven controls improperly set.	• Make sure you touch the BROIL HI/LO pad.
	Improper rack position being used.	• See the <i>Broiling Guide</i> .
	Cookware not suited for broiling.	• For best results, use a pan designed for broiling.
	The probe is plugged into the outlet in the oven. (on some models)	• Unplug and remove the probe from the oven.
	In some areas the power (voltage) may be low.	• Preheat the broil element for 10 minutes. • Broil for the longest period of time recommended in the <i>Broiling Guide</i> .
<i>Oven temperature too hot or too cold</i>	Oven thermostat needs adjustment.	• See the <i>Adjust the oven thermostat—Do it yourself!</i> section.
<i>Oven door is crooked</i>	The door is out of position.	• Because the oven door is removable, it sometimes gets out of position during installation. To straighten the door, push down on the high corner.

Before You Call For Service...



Troubleshooting Tips

<i>Problem</i>	<i>Possible Causes</i>	<i>What To Do</i>
<i>Clock and timer do not work</i>	Plug on range is not completely inserted in the electrical outlet.	<ul style="list-style-type: none"> • Make sure electrical plug is plugged into a live, properly grounded outlet.
	A fuse in your home may be blown or the circuit breaker tripped.	<ul style="list-style-type: none"> • Replace the fuse or reset the circuit breaker.
	Oven controls improperly set.	<ul style="list-style-type: none"> • See the <i>Using the clock, kitchen timer and control lockout</i> section.
<i>Oven will not self-clean</i>	The oven temperature is too high to set a self-clean operation.	<ul style="list-style-type: none"> • Allow the range to cool and reset the controls.
	Oven controls improperly set.	<ul style="list-style-type: none"> • See the <i>Using the self-cleaning oven</i> section.
	The probe is plugged into the outlet in the oven. (on some models)	<ul style="list-style-type: none"> • Remove the probe from the oven.
<i>"Crackling" or "popping" sound</i>	This is the sound of the metal heating and cooling during both the cooking and cleaning functions.	<ul style="list-style-type: none"> • This is normal.
<i>Excessive smoking during a clean cycle</i>	Excessive soil.	<ul style="list-style-type: none"> • Touch the <i>CLEAR/OFF</i> pad. Open the windows to rid the room of smoke. Wait until <i>LOCKED/DOOR</i>  goes off. After the oven cools, wipe up the excess soil and reset the clean cycle.
<i>Oven door will not open after a clean cycle</i>	Oven too hot.	<ul style="list-style-type: none"> • Allow the oven to cool below locking temperature.
<i>Oven not clean after a clean cycle</i>	Oven controls not properly set.	<ul style="list-style-type: none"> • See the <i>Using the self-cleaning upper and lower ovens</i> section.
	Oven was heavily soiled.	<ul style="list-style-type: none"> • Clean up heavy spillovers before starting the clean cycle. Heavily soiled ovens may need to self-clean again or for a longer period of time.
<i>"LOCKED" flashes in the display</i>	The self-clean cycle has been selected but the door is not closed.	<ul style="list-style-type: none"> • Close the oven door.
<i>"LOCKED" is on when you want to cook</i>	The oven door is locked because the temperature inside the oven has not dropped below the locking temperature.	<ul style="list-style-type: none"> • Touch the <i>CLEAR/OFF</i> pad. Allow the oven to cool.
<i>"F—" and a number or letter flash in the display</i>	You have a function error code.	<ul style="list-style-type: none"> • Disconnect all power to the range for at least 30 seconds and then reconnect power. If the function error code repeats, call for service.

Problem	Possible Causes	What To Do
Range Locked or LOC On appears in the oven display or LC appears in the surface display	The controls have been locked.	<ul style="list-style-type: none"> See the <i>Control Lockout</i> section to unlock.
Control signals after entering cooking time or start time	You forgot to enter a bake temperature or cleaning time.	<ul style="list-style-type: none"> Touch the BAKE pad and desired temperature or the SELF CLEAN pad and desired clean time.
Display goes blank	A fuse in your home may be blown or the circuit breaker tripped.	<ul style="list-style-type: none"> Replace the fuse or reset the circuit breaker.
	The clock is in the black-out mode.	<ul style="list-style-type: none"> See the <i>Special features of your oven control</i> section.
Display flashes	Power failure.	<ul style="list-style-type: none"> Reset the clock.
Unable to get the display to show "SF"	Oven control pads were not touched properly.	<ul style="list-style-type: none"> The BROIL HI/LO and BAKE pads must be touched at the same time and held for 3 seconds.
"Probe" appears in the display (on some models)	This is reminding you to enter a probe temperature after plugging in the probe.	<ul style="list-style-type: none"> Enter a probe temperature.
Power outage, clock flashes	Power outage or surge.	<ul style="list-style-type: none"> Reset the clock. If the oven was in use, you must reset it by touching the CLEAR/OFF pad, setting the clock and resetting any cooking function.
Steam from the vent	When using the ovens, it is normal to see steam coming out of the oven vents. As the number of racks or amount of food being cooked increases, the amount of visible steam will increase.	<ul style="list-style-type: none"> This is normal.
"Burning" or "oily" odor emitting from the vent	This is normal in a new oven and will disappear in time.	<ul style="list-style-type: none"> To speed the process, set a self-clean cycle for a minimum of 3 hours. See the <i>Using the self-cleaning upper and lower ovens</i> section.
Strong odor	An odor from the insulation around the inside of the oven is normal for the first few times the oven is used.	<ul style="list-style-type: none"> This is temporary.
Fan noise	A convection fan may automatically turn on and off.	<ul style="list-style-type: none"> This is normal. To maximize cooking evenness, the fan is designed to operate in both directions, with a pause in between. The convection fan will operate during preheat of the bake cycle. The fan will turn off after the oven is heated to the set temperature. This is normal.
"CLOSE DOOR" flashes or scrolls in the display.	This is a normal condition. The "CLOSE DOOR" is a reminder message to keep the oven door closed during broil mode.	<ul style="list-style-type: none"> This is normal. Keep oven door closed during broil mode.

Before You Call For Service...



Troubleshooting Tips

Problem	Possible Causes	What To Do
<i>Oven racks are difficult to slide</i>	The shiny, silver-colored racks were cleaned in a self-clean cycle.	<ul style="list-style-type: none"> Apply a small amount of vegetable oil to a paper towel and wipe the edges of the oven racks with the paper towel. Do not spray with Pam® or other lubricant sprays.
<i>Drawer does not slide smoothly or drags</i>	The drawer is out of alignment.	<ul style="list-style-type: none"> Fully extend the drawer and push it all the way in. See the <i>Care and cleaning of the range</i> section.
	Drawer is over-loaded or load is unbalanced.	<ul style="list-style-type: none"> Reduce weight. Redistribute drawer contents.
<i>Warming drawer or lower oven drawer will not work</i>	A fuse in your home may be blown or the circuit breaker tripped.	<ul style="list-style-type: none"> Replace the fuse or reset the circuit breaker.
	Controls improperly set.	<ul style="list-style-type: none"> See the <i>Using the warming drawer</i> section.
<i>Excessive condensation in the drawer</i>	Liquid in drawer.	<ul style="list-style-type: none"> Remove liquid.
	Uncovered foods.	<ul style="list-style-type: none"> Cover food with lid or aluminum foil.
	Temperature setting too high.	<ul style="list-style-type: none"> Reduce temperature setting.
<i>Food dries out in the warming drawer</i>	Moisture escaping.	<ul style="list-style-type: none"> Cover food with lid or aluminum foil.
	Drawer not fully closed.	<ul style="list-style-type: none"> Push drawer in until latch engages.

Notes.

Safety Instructions	Operating Instructions	Care and Cleaning	Troubleshooting Tips	Consumer Support
---------------------	------------------------	-------------------	----------------------	------------------

Accessories.



Looking For Something More?

You can find these accessories and many more at www.GEAppliances.ca, or call 800.661.1616 (during normal business hours). Have your model number ready.

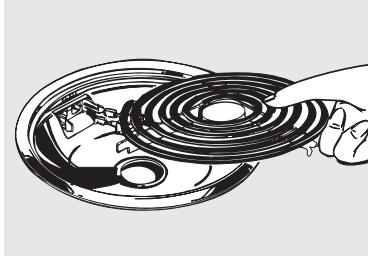

Surface Elements & Drip Pans

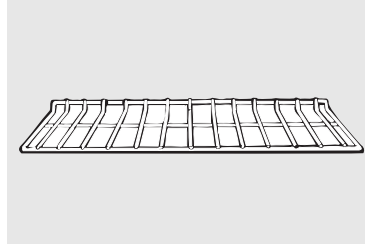

Oven Racks

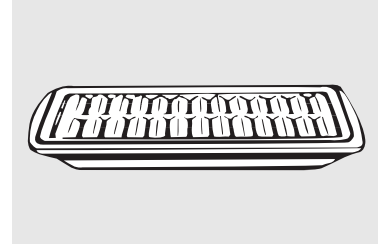

Broiler Pan

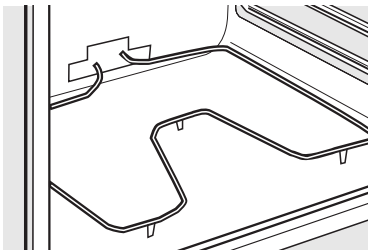

Oven Elements

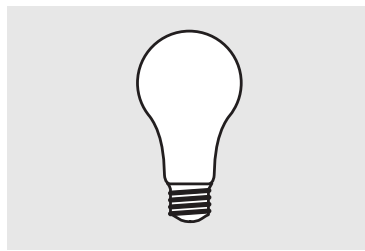

Light Bulbs

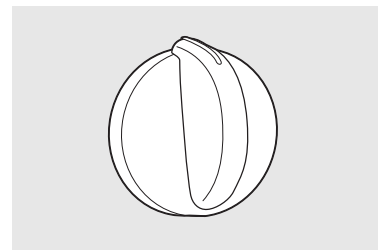

Knobs



Cleaner

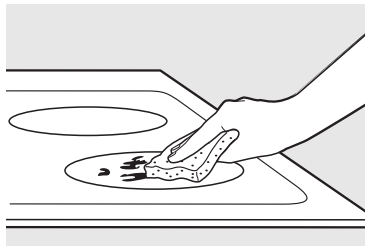

Cleaning Pads

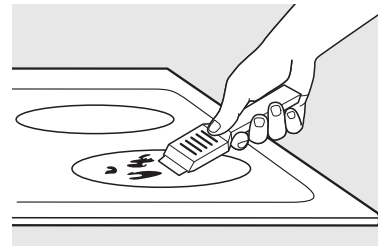

Scraper

Tired of discolored racks? Wishing you had extra-heavy-duty oven racks?

NOW AVAILABLE for your range:

GE's innovative, self-cleanable porcelain-coated oven racks!

- Heavy Duty
- Durable
- Able to be cleaned in a self-cleaning oven

Visit www.GEAppliances.ca for more information.

Please place in envelope and mail to:
Veuillez mettre dans une enveloppe et envoyez à :

OWNERSHIP REGISTRATION
P.O. BOX 1780
MISSISSAUGA, ONTARIO
L4Y 4G1

(FOR CANADIAN CONSUMERS ONLY)



For Canadian
Customers



Pour les
Consommateurs
Canadiens

CUT ALONG THIS LINE AND RETURN CARD—THANKS

OWNERSHIP REGISTRATION CERTIFICATE – FICHE D'INSCRIPTION DU PROPRIÉTAIRE

Please register your product to enable us to contact you in the remote event a safety notice is issued for this product and to allow for efficient communication under the terms of your warranty, should the need arise.

Veillez enregistrer votre produit afin de nous permettre de communiquer avec vous si jamais un avis de sécurité concernant ce produit était émis et de communiquer facilement avec vous en vertu de votre garantie, si le besoin s'en fait sentir.

REGISTER ON-LINE: ENREGISTREMENT SUR INTERNET À :		www.geappliances.ca		MAIL TO: POSTER À :	P.O. BOX 1780, MISSISSAUGA ONTARIO, L4Y 4G1
<input type="checkbox"/> MR./M	<input type="checkbox"/> MRS./MME.	FIRST NAME / PRÉNOM		LAST NAME / NOM	
<input type="checkbox"/> MISS/MLE.	<input type="checkbox"/> MS.				
STREET NO / N° RUE		STREET NAME / RUE			APT. NO / APP. / RR#
CITY / VILLE				PROVINCE	POSTAL CODE / POSTAL
AREA CODE / IND. RÉG.	TELEPHONE	E-MAIL			
DID YOU PURCHASE A SERVICE CONTRACT FOR THIS APPLIANCE? AVEZ-VOUS ACHETÉ UN CONTRAT DE SERVICE POUR CET APPAREIL ?				YES / OUI <input type="checkbox"/>	IF YES / SI OUI: EXPIRATION
				NO / NON <input type="checkbox"/>	Y/A M D/J
NAME OF SELLING DEALER / NOM DU MARCHAND				MODEL / MODÈLE	
INSTALLATION DATE / DATE D'INSTALLATION Y/A M D/J		CORRESPONDENCE CORRESPONDANCE	<input type="checkbox"/> ENGLISH <input type="checkbox"/> FRANÇAIS	SERIAL / SÉRIE	
<input type="checkbox"/> I do not wish to receive any promotional offers regarding this product. <input type="checkbox"/> Je ne désire pas recevoir d'offres promotionnelles concernant ce produit.					

Notes.

Safety Instructions	Operating Instructions	Care and Cleaning	Troubleshooting Tips	Consumer Support
---------------------	------------------------	-------------------	----------------------	------------------

Consumer Support	Troubleshooting Tips	Care and Cleaning	Operating Instructions	Safety Instructions
------------------	----------------------	-------------------	------------------------	---------------------

Notes.

GE Electric Range Warranty.

www.GEAppliances.ca



All warranty service provided by our Factory Service Centres or an authorized Customer Care® technician. To schedule service, visit us on-line at www.GEAppliances.ca or call 1.800.561.3344. Please have serial number and model number available when calling for service.

Staple your receipt here.
Proof of the original purchase date is needed to obtain service under the warranty.

For The Period Of:	Mabe Will Provide:
One Year From the date of the original purchase	Any part of the range which fails due to a defect in materials or workmanship. During this limited one-year warranty , Mabe will also provide, free of charge , all labor and in-home service to replace the defective part.

What Mabe Will Not Cover:

- Service trips to your home to teach you how to use the product.
- Replacement of house fuses or resetting of circuit breakers.
- Improper installation, delivery or maintenance.
- Damage to the product caused by accident, fire, floods or acts of God.
- Failure of the product if it is abused, misused, or used for other than the intended purpose or used commercially.
- Incidental or consequential damage caused by possible defects with this appliance.
- Damage to the glass cooktop caused by use of cleaners other than the recommended cleaning creams and pads.
- Damage caused after delivery.
- Damage to the glass cooktop caused by hardened spills of sugary materials or melted plastic that are not cleaned according to the directions in the Owner's Manual.
- Product not accessible to provide required service.

EXCLUSION OF IMPLIED WARRANTIES—Your sole and exclusive remedy is product repair as provided in this Limited Warranty. Any implied warranties, including the implied warranties of merchantability or fitness for a particular purpose, are limited to one year or the shortest period allowed by law.

This warranty is extended to the original purchaser and any succeeding owner for products purchased in Canada for home use within Canada. In-home warranty service will be provided in areas where it is available and deemed reasonable by Mabe to provide.

Some provinces do not allow the exclusion or limitation of incidental or consequential damages, so the above exclusion may not apply to you. This warranty gives you specific legal rights, and you may also have other rights which vary from province to province. To know what your legal rights are in your province, consult your local or provincial consumer affairs office.

Warrantor: Mabe Canada Inc.,
Burlington, Ontario

Safety Instructions

Operating Instructions

Care and Cleaning

Troubleshooting Tips

Consumer Support

Consumer Support.



GE Appliances Website

www.GEAppliances.ca

Have a question or need assistance with your appliance? Try the GE Appliances Website 24 hours a day, any day of the year! For greater convenience and faster service, you can now download Owner's Manuals on-line.



Schedule Service

www.GEAppliances.ca

Expert GE repair service is only one step away from your door. Call 1.800.561.3344, 7 days a week.

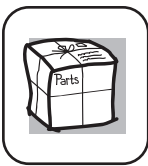

Parts and Accessories

www.GEAppliances.ca

To inquire about purchasing a part or an accessory for your appliance, call our National Parts Centre at 1.800.661.1616.



Contact Us

www.GEAppliances.ca

If you are not satisfied with the service you receive from GE, contact us on our Website with all the details including your phone number, or write to:

Mabe Canada Inc.
1 Factory Lane
Moncton, New Brunswick
E1C 9M3



Register Your Appliance

www.GEAppliances.ca

Register your new appliance on-line—at your convenience! Timely product registration will allow for enhanced communication and prompt service under the terms of your warranty, should the need arise. You may also mail in the preprinted registration card included in the packing material.