

Owner's Manual

Automatic
Ice Maker

ZDIC150
ZDIS150



Consumer Information

Ice maker

Contents

Care and Cleaning.....	10–12	Problem Solver.....	13, 14
Consumer Services.....	15	Product Registration.....	2
Controls and Features.....	7, 8	Repair Service.....	2
Important Phone Numbers.....	15	Important Safety Instructions.....	3–5
Model and Serial Numbers.....	2	Warranty.....	Back Cover
Operating Instructions.....	9		

Before using your ice maker

Read this manual carefully. It is intended to help you operate and maintain your new ice maker properly.
Keep it handy for answers to your questions.

If you don't understand something or need more help, there is a list of toll-free consumer service numbers included in the back section of this manual.

OR

Visit our Website at: monogram.com

Write down the model & serial numbers

You'll find them on a label on the right wall of the ice storage bin.

These numbers are also on the Consumer Product Ownership Registration Card packed separately with your ice maker.

Please write these numbers here:

Model Number

Serial Number

Use these numbers in any correspondence or service calls concerning your ice maker.

If you received a damaged ice maker

Immediately contact the dealer (or builder) that sold you the ice maker.

If you need service

To obtain service, see the *Consumer Services* page in the back of this manual.

We're proud of our service and want you to be pleased. If for some reason you are not happy with the service you receive, follow these steps.

FIRST, contact the people who serviced your appliance. Explain why you are not pleased. In most cases, this will solve the problem.

NEXT, contact us at GEAppliances.com or call 800.GE.CARES.

IMPORTANT SAFETY INSTRUCTIONS

READ AND SAVE THESE INSTRUCTIONS

Before it is used, the ice maker must be properly installed and located as described in this manual.

⚠ WARNING: To reduce the risk of death, fire, electrical shock or injury when using your ice maker, follow basic precautions including the following:

- Never allow children to operate, play with or crawl inside the ice maker.
- Never clean ice maker parts with flammable fluids. The fumes can create a fire hazard or explosion.
- Do not store or use gasoline or other flammable vapors and liquids in the vicinity of this or any other appliance. The fumes can create a fire hazard or explosion.
- Be sure your ice maker is properly installed and grounded by a qualified technician in accordance with the Installation Instructions.
- Do not attempt to repair or replace any part of your ice maker unless it is specifically recommended in this manual. All other servicing should be referred to a qualified technician.

- **Unplug the ice maker or disconnect power before cleaning, servicing or changing the light bulb.** Failure to do so can result in death or electrical shock.

- **It is your responsibility to be sure your ice maker:**

- has been installed where it is protected from the elements.
- is located so that the front is not blocked to restrict incoming or discharge air flow.
- is connected only to the proper kind of outlet, with the correct electric supply and grounding. A 115 volt, 60 Hz., 15 amp fused electrical supply is required.
NOTE: Time delay fuse or circuit breaker is recommended.
- is not used by anyone unable to operate it properly.
- is used only to do what ice makers are designed to do.
- is properly maintained.

IMPORTANTES INSTRUCTIONS DE SÉCURITÉ

LIRE ET CONSERVER CES INSTRUCTIONS

Avant son utilisation, la machine à glaçons doit être bien installée et située selon la description dans ce manuel.

⚠ AVERTISSEMENT : Pour réduire les risques d'incendie, de choc électrique ou de blessure lors de l'utilisation de la machine à glaçons, suivre les précautions fondamentales, y compris les suivantes :

- Ne jamais laisser les enfants utiliser, employer comme jouet ou pénétrer dans la machine à glaçons.
- Ne jamais nettoyer les pièces de la machine à glaçons avec des fluides inflammables. Les émanations peuvent créer un risque d'incendie ou d'explosion.
- Ne pas entreposer ni utiliser de l'essence ou d'autres vapeurs et liquides inflammables dans le voisinage de cet appareil ménager ou de tout autre appareil. Les émanations peuvent créer un risque d'incendie ou d'explosion.
- S'assurer que la machine à glaçons est bien installée et reliée à la terre par un technicien qualifié, et conformément aux instructions d'installation.
- Ne pas essayer de réparer ou de remplacer une pièce de votre machine à glaçons à moins de recommandations spécifiques dans ce manuel.

Tout autre besoin de service doit être soumis à un technicien qualifié.

- **Débrancher la machine à glaçons ou déconnecter le courant électrique avant de la nettoyer, de l'entretenir ou de changer l'ampoule d'éclairage.** L'omission d'observer ces précautions peut causer un décès ou un choc électrique.

- **Vous avez la responsabilité de vous assurer que la machine à glaçons :**

- a été installée où elle est protégée contre les intempéries.
- est située de sorte que le devant n'est pas obstruée pour restreindre l'arrivée ou la sortie du courant d'air.
- est connectée seulement au type approprié de prise de courant avec une alimentation électrique correcte et une liaison à la terre. Une alimentation électrique de 115 V, 60 Hz, et fusible de 15 A est requise.

REMARQUE : Les fusibles temporisés ou disjoncteurs de circuit sont recommandés.

- n'est pas utilisée par quiconque ne peut faire fonctionner l'appareil d'une manière appropriée.
- est utilisée seulement pour accomplir ce que les machines à glaçons sont destinées à fournir.
- est soumise à un entretien approprié.

IMPORTANT SAFETY INSTRUCTIONS

⚠ WARNING! Failure to follow these instructions can result in death, fire, or electrical shock.

⚠ AVERTISSEMENT! Le non-respect de ces instructions peut causer la mort, un incendie ou un choc électrique.

HOW TO CONNECT ELECTRICITY

Do not, under any circumstances, cut or remove the third (ground) prong from the power cord. For personal safety, this appliance must be properly grounded.

The power cord of this appliance is equipped with a 3-prong (grounding) plug which mates with a standard 3-prong (grounding) wall outlet to minimize the possibility of electric shock hazard from this appliance.

Have the wall outlet and circuit checked by a qualified electrician to make sure the outlet is properly grounded.

Where a standard 2-prong wall outlet is encountered, it is your personal responsibility and obligation to have it replaced with a properly grounded 3-prong wall outlet.

The ice maker should always be plugged into its own individual electrical outlet which has a voltage rating that matches the rating plate. This provides the best performance and also prevents overloading house wiring circuits which could cause a fire hazard from overheated wires.

Never unplug your ice maker by pulling on the power cord. Always grip plug firmly and pull straight out from the outlet.

Repair or replace immediately all power cords that have become frayed or otherwise damaged. Do not use a cord that shows cracks or abrasion damage along its length or at either end.

When moving the ice maker, be careful not to roll over or damage the power cord.

RACCORDEMENT ÉLECTRIQUE

Ne coupez ni retirez en aucun cas la troisième broche (mise à la terre) de la fiche du cordon d'alimentation. Pour votre sécurité, cet appareil doit être correctement mis à la terre.

Le cordon d'alimentation de cet appareil est muni d'une fiche à 3 broches (mise à la terre) qui se branche dans une prise mural ordinaire à 3 alvéoles (mise à la terre) pour réduire au minimum les risques du chocs électriques.

Faites examiner la prise de courant et le circuit par un électricien qualifié pour vous assurer que la prise est correctement mise à la terre.

Si la prise murale est du type standard à 2 alvéoles, il vous incombe de la faire remplacer par une prise à 3 alvéoles correctement mise à la terre.

La machine à glaçons doit toujours être branché dans sa propre prise de courant, dont la tension nominale est identique à celle indiquée sur la plaque signalétique.

Cette précaution est recommandée pour garantir un rendement optimum et éviter une surcharge des circuits électriques de la résidence, ce qui pourrait créer un risque d'incendie par surschauffe des fils.

Ne débranchez jamais la machine à glaçons en tirant le cordon d'alimentation. Saisissez fermement la fiche du cordon et tirez droit pour la retirer de la prise.

Réparez ou remplacez immédiatement tout cordon effiloché ou endommagé. N'utilisez pas un cordon fendillé ou présentant des signes d'usure.

Lorsque vous déplacez votre machine à glaçons du mur, faites attention de ne pas la faire rouler sur le cordon d'alimentation afin de ne pas l'endommager.

EXTENSION CORDS

Do not use an extension cord with this appliance.

RALLONGES

N'utilisez pas de rallonge avec cet appareil.

IMPORTANT SAFETY INSTRUCTIONS

⚠ DANGER: RISK OF CHILD ENTRAPMENT

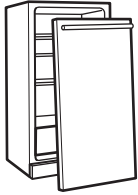

Child entrapment and suffocation are not problems of the past. Junked or abandoned refrigeration products are still dangerous... even if they will sit for "just a few days." If you are getting rid of your old appliance, please follow these instructions to help prevent accidents.

Before You Throw Away Your Old Refrigeration Product:

- Take off the doors.
- Leave the shelves in place so that children may not easily climb inside.

⚠ DANGER! RISQUES POUR LES ENFANTS

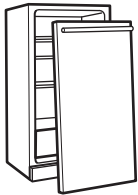

Les enfants pris au piège ou morts d'asphyxie sont toujours d'actualité. Les appareils de réfrigération abandonnés sont toujours aussi dangereux, même si on n'attend que "quelque jours" pour s'en débarrasser. Si vous ne gardez pas votre ancien appareil, veuillez suivre les directives ci-dessous afin de prévenir les accidents.

Avant de vous débarrasser de votre vieux appareil de réfrigération :

- Démontez les portes.
- Laissez les clayettes en place afin d'empêcher les enfants de grimper à l'intérieur.

REFRIGERANTS

All refrigeration products contain refrigerants, which under federal law must be removed prior to product disposal. If you are getting rid of an old refrigeration product, check with the company handling the disposal about what to do.

RÉFRIGÉRANTS

Tous les appareils de réfrigération contiennent des réfrigérants qui, conformément aux lois fédérales, doivent être enlevés avant toute élimination de l'appareil. Si vous vous débarrassez de vieux appareils de réfrigération, vérifiez, auprès de la société qui s'occupe de leur élimination, ce que vous devez faire.

Controls and Features

Ice maker

Remove packaging

IMPORTANT: Do not remove any permanent instruction labels inside your ice maker or the Tech Sheet that is fastened behind the lower access panel.

- Remove tape and any labels from your ice maker before using (except the model and serial number label).

To remove any remaining tape or glue, rub the area briskly with your thumb. Tape or glue residue can also be easily removed by rubbing a small amount of liquid dish soap over the adhesive with your fingers. Wipe with warm water and dry.

- Do not use sharp instruments, rubbing alcohol, flammable fluids or abrasive cleaners to remove tape or glue. These products can damage the surface of your ice maker. For more information, see *Important Safety Instructions*.

Clean before using

After you remove all of the packaging materials, clean the inside of your ice maker before using it.

See the cleaning instructions in *Care and Cleaning*.

Set controls

ON/OFF

Press ON/OFF to start ice production or stop ice maker operation. When the ice maker is in ON mode, ice production is in progress and the ON/OFF LED light will be on. When ice maker is in OFF mode and ice maker operations are turned off, the ON/OFF LED will remain off.

When ice production is turned on, the ice maker will automatically enter Quick Ice Mode for the first 24 hours.

NOTE: Allow 24 hours to produce the first batch of ice after installing ice maker. Discard the first two batches produced after installation.

NOTE: Power to the ice maker is not shut off when the ice maker is in OFF mode.

To stop ice maker operation, press ON/OFF.

QUICK ICE MODE

Press QUICK ICE to start or stop more rapid ice production. Select the QUICK ICE feature when you have an upcoming need for a large amount of ice and the bin is low or empty. Quick Ice Mode will produce a greater quantity of ice in a 24-hour period.

The QUICK ICE indicator light is illuminated when the ice maker is in Quick Ice Mode.

Pressing QUICK ICE to turn Quick Ice Mode off will not stop ice production.

CLEAN

It is recommended that you clean the ice maker if the CLEANING NEEDED light is illuminated, if 6 months have elapsed since the last cleaning, or if ice production decreases significantly. To clean your ice maker, see *Care and Cleaning -- Cleaning Cycle*.

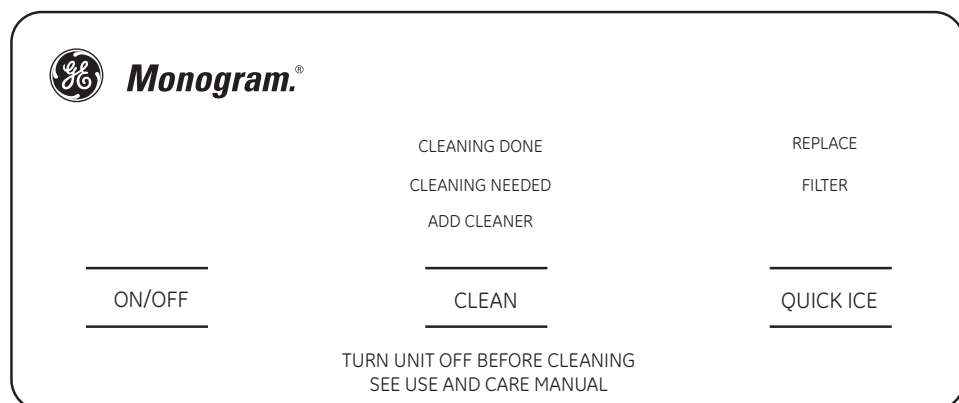

Control messages

REPLACE FILTER will illuminate when the control system recommends installing a new filter or when the control system senses that a filter is not inserted in the ice maker. See Care and Cleaning - Ice Maker System.

CLEANING NEEDED will illuminate when the control system recommends a CLEAN cycle. See Care and Cleaning - Ice Maker System.

ADD CLEANER will illuminate when a CLEAN cycle has been initiated but no cleaning solution is in the reservoir. See *Care and Cleaning -- Cleaning Cycle*.

CLEANING DONE will illuminate when the CLEAN cycle is complete.

If the ON/OFF LED is flashing, see The Problem Solver.

The Door Ajar Alarm feature will sound an alarm when the ice maker door has been open for 5 minutes. The alarm will repeat every 2 minutes. Close the door to turn off the alarm and reset the feature.

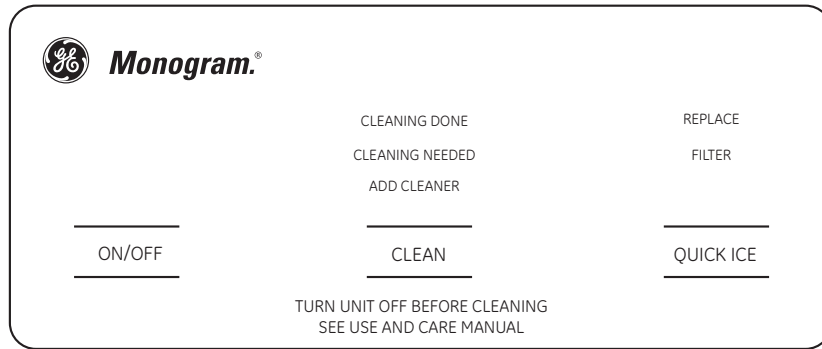

Features of your ice maker

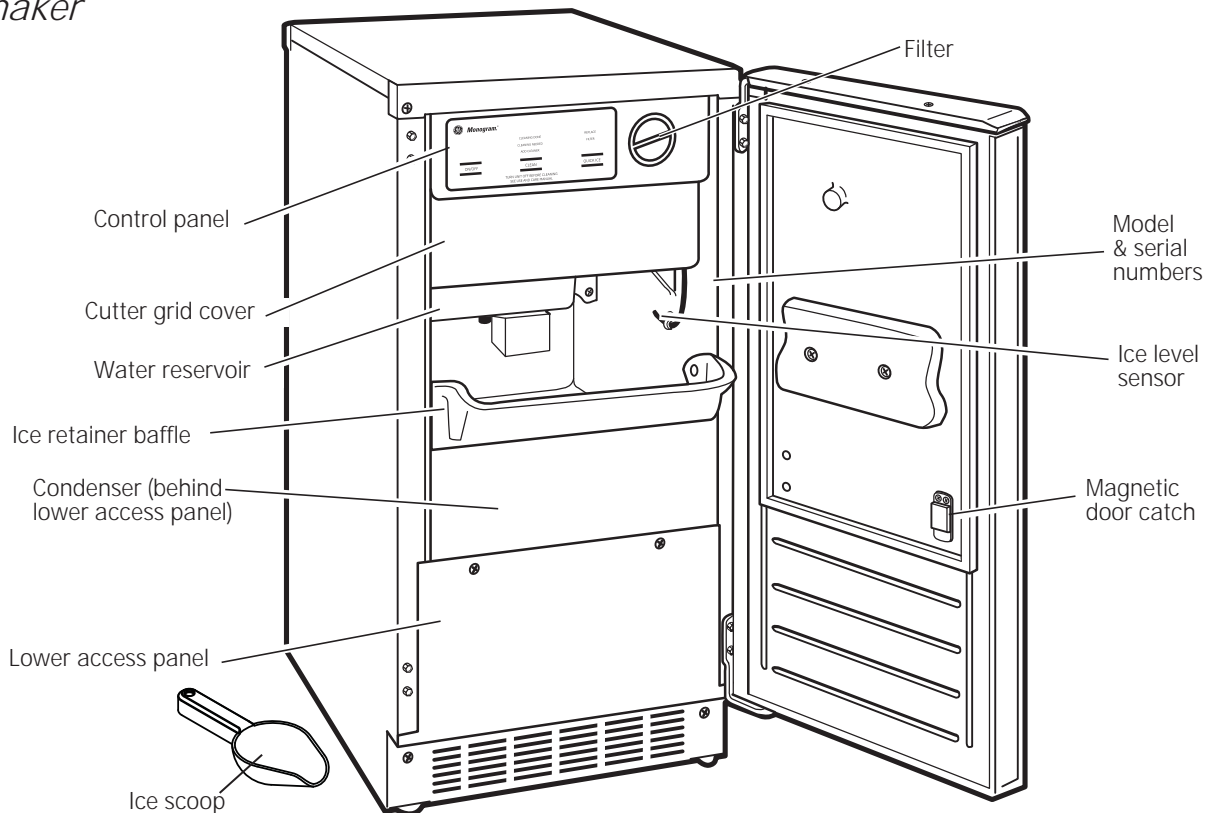

Operating Instructions

Ice maker

How your ice maker works

When you first start your ice maker, the water will flow through the filter and fill the reservoir. The system will rinse itself before starting to make ice. The rinsing process takes about five minutes.

Under normal operating conditions, the ice maker will cycle on and off as needed. The ice level sensor located in the ice storage bin will monitor the ice levels.

IMPORTANT

If the water supply to the ice maker is turned off, be sure to set the ice maker control to OFF. Drain the water reservoir and leave the ice maker door open to allow it to dry completely.

Making Ice

1. Water is constantly circulated over a freezing plate. As the water freezes into ice, the minerals in the water are rejected. This produces a clear sheet of ice with a low mineral content.

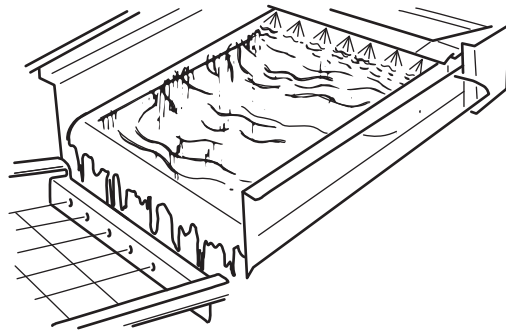

2. When the desired thickness is reached, the ice sheet is released and slides onto a cutter grid. The grid divides the sheet into individual cubes.

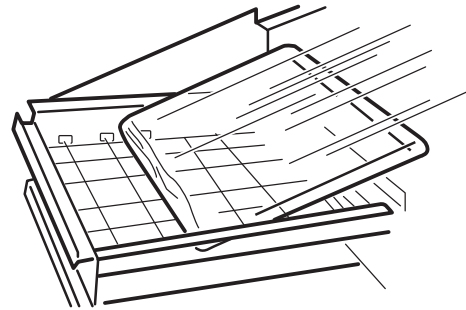

3. The water containing the rejected minerals is drained after each freezing cycle.
4. Fresh water enters the machine and is filtered for the next ice making cycle.
5. Cubes fall into the storage bin. When the bin is full, the ice maker shuts off automatically and restarts when more ice is needed. The ice bin is not refrigerated and some melting will occur. The amount of melting varies with room temperature.

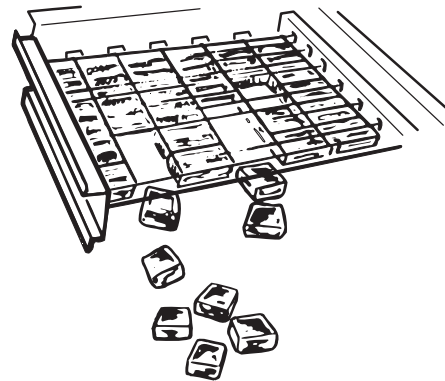

NOTE: As the room and water temperatures vary, so will the amount of ice produced and stored. This means that higher operating temperatures result in reduced ice production.

Ice maker system care

CLEANING NEEDED will illuminate when the electronic control senses that the need for cleaning is approaching. At this time you need to purchase Nickel Safe Ice Machine Cleaner by Nu Calgon, available at most appliance repair shops or through GE Parts and Accessories. Order part number WX08X42870. In the U.S.A., call 1.800.626.2002. or visit GEAplianceParts.com. In Canada call 1.800.561.3344. The ice maker must be cleaned, otherwise ice production may decrease significantly or stop.

REPLACE FILTER will illuminate when the electronic control senses that the filter needs to be replaced. At this time you need to purchase a replacement filter, part number IMWF, through GE parts at www.gewaterfilters.com or in the US call 1.800.626.2002.

Product designed and tested for use with genuine GE water filters. Non-GE filters are not covered under product warranty.

Exterior surfaces

Keep the outside clean. Wipe with a clean cloth lightly dampened with mild liquid dish detergent. Dry with a clean, soft cloth. Do not wipe the ice maker with a soiled dish cloth or wet towel. These may leave a residue that can damage the finish. Do not use scouring pads, powdered cleaners, bleach or cleaners containing bleach because these products can scratch and damage the finish.

Stainless steel—Regularly clean and polish the stainless steel door panels and handles (on some models) with a commercially available stainless steel cleaner such as *Stainless Steel Magic™* to preserve and protect the fine finish. Order part number WX10X15. In the U.S.A. call 1.800.626.2002 or visit GEAplianceParts.com. In Canada call 1.800.561.3344.

Do not use appliance wax or polish on the stainless steel.

Interior components

⚠ WARNING: Disconnect electrical power to the ice maker before cleaning. Failure to do so can result in death, fire, or electrical shock.

⚠ AVERTISSEMENT !
Débranchez l'alimentation électrique à la machine à glaçons avant le nettoyage. L'omission de prendre cette précaution peut entraîner la mort, l'incendie ou le choc électrique.

1. Open the storage bin door and remove any ice that is in the bin.
2. Pull out on the bottom of the cutter grid cover until the snaps release to remove.
3. Remove ice scoop and ice scoop holder. Remove the two screws using a 1/4" ratchet.

NOTE: Do not remove hoses. Do not wash plastic parts in dishwasher. They cannot withstand temperatures above 145°F (63°C).

4. With mild soap and warm water wash the storage bin, ice scoop and holder, cutter

grid cover, door gasket, and secured interior components (cutter grid, exterior of hoses, and water reservoir). Rinse with clean water.

5. Clean the same parts again with a solution of 1 tbsp. (15 ml) of household bleach in 1 gal. (3.8 L) warm water. Rinse thoroughly with clean water.
6. Gently wipe the control panel with a soft, clean dishcloth using warm water and a mild liquid dish detergent.
7. Replace ice scoop holder.
8. Replace the cutter grid cover by aligning top tabs and pushing to snap into place.
9. Plug in ice maker or reconnect power.

NOTE: The air cooled condenser needs to be cleaned regularly for efficient ice production and energy conservation. See *Care and Cleaning - Condenser* section.

Cleaning cycle

For best performance, perform a cleaning cycle every six months. Nickel Safe Ice Machine Cleaner by Nu Calgon is available at appliance repair shops, or through GE Parts and Accessories. Order part number WX08X42870. In the U.S.A., call 1.800.626.2002 or visit GEApplianceParts.com. In Canada, call 1.800.561.3344. To clean ice maker system, follow these instructions.

1. Turn ice production off. Remove all ice from storage bin.
2. To improve accessibility, remove cutter grid cover by pulling bottom of cover down and then forward.
3. Unscrew the drain cap from the bottom of the water reservoir. Drain all water in reservoir.

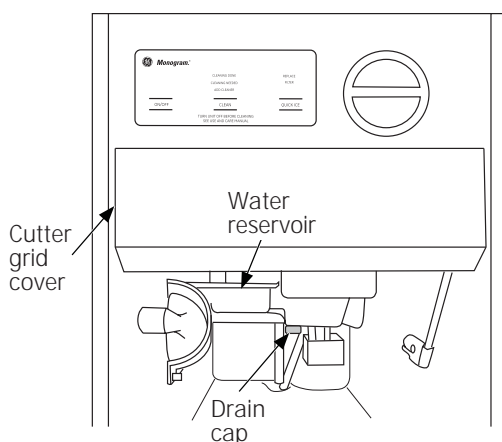

4. Replace the drain cap securely.

NOTE: If the cap is not securely tightened, water can leak, causing thin ice or no ice.
5. Pour the entire 16 oz. bottle of Nickel Safe Ice Machine Cleaner into water reservoir. Follow all safety precautions on the bottle. Fill the bottle twice with tap water and pour it into the water

reservoir.

6. Replace the cutter grid cover. Insert the top tabs first, and then push toward cutter grid to snap into place.
7. Touch the **CLEAN** button. The **CLEAN** LED will illuminate and the cleaning cycle will begin. If Invalid Tone plays, press the **ON/OFF** button to turn the ice maker off and try again. If "ADD

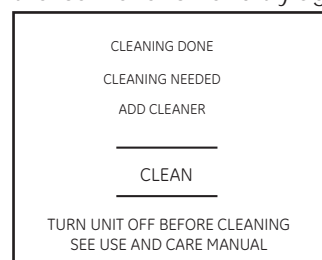

"CLEANER" illuminates, see previous steps.

8. When the cycle is complete the **CLEAN** LED will turn off, the Cycle Complete tone will sound, and the "CLEANING DONE" text will illuminate.
9. After the cleaning cycle is complete, remove the drain cap from the water reservoir to see if any of the green cleaning solution is left in the water reservoir. If cleaning solution drains from the water reservoir, you should run the clean cycle again adding only tap water to the reservoir. Be sure to replace the drain cap before running the cycle again.

NOTE: Severe scale buildup may require repeated cleaning with a fresh quantity of cleaning solution.

10. Press the **ON/OFF** button to resume ice production. Discard the first batch of ice.

NOTE: To stop the cleaning cycle prematurely, press **ON/OFF**. The **CLEAN** LED will turn off and you will hear the Power Off tone. If power is lost before cycle is complete, cleaning will continue when the ice maker powers on.

Condenser

⚠ WARNING: Disconnect electrical power to the ice maker before cleaning. Failure to do so can result in death, fire, or electrical shock.

⚠ AVERTISSEMENT !
Débranchez l'alimentation électrique à la machine à glaçons avant le nettoyage. L'omission de prendre cette précaution peut entraîner la mort, l'incendie ou le choc électrique.

For best performance, brush or vacuum lint and dirt from the condenser at least once a year.

A dirty or clogged condenser:

- Uses more energy.
- Prevents proper airflow.
- Reduces ice making capacity.
- Causes higher than recommended operating temperatures which may lead to component failure.

1. Unplug the ice maker or disconnect power.
2. Remove the 2 screws in the lower access panel and the 2 screws from the base grille area of the front panel support.

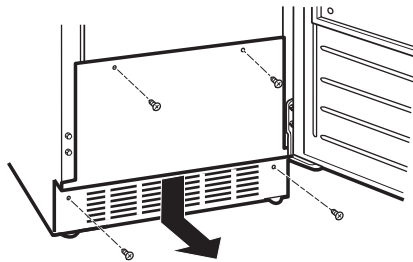

3. Pull the bottom forward and then pull down to remove the lower access panel.
4. Remove dirt and lint from the condenser fins and the unit compartment with a brush attachment attached to a vacuum cleaner.

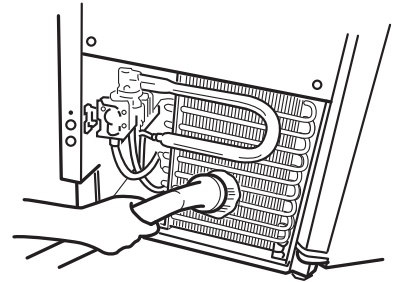

5. Replace the lower access panel using the 4 screws.
6. Plug in the ice maker or reconnect power.

Care and Cleaning

Ice maker

Filter replacement

Product designed and tested for use with genuine GE water filters. Non-GE filters are not covered under product warranty. Order part number IMWF. In the U.S.A. call 1.800.626.2002 or visit GEApplianceParts.com. In Canada call 1.800.561.3344.

1. Locate the water filter on the right-hand side of the ice maker controls.
2. Remove the filter by rotating counterclockwise from the lock to unlock position.

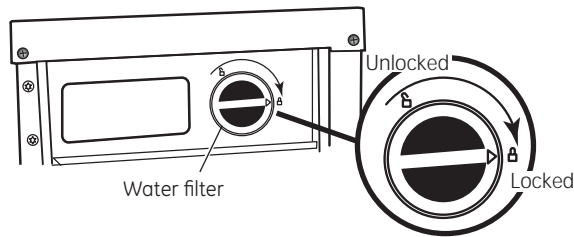

3. Remove the cover from the new water filter. Be sure the O-rings are still in place after the cover is removed.

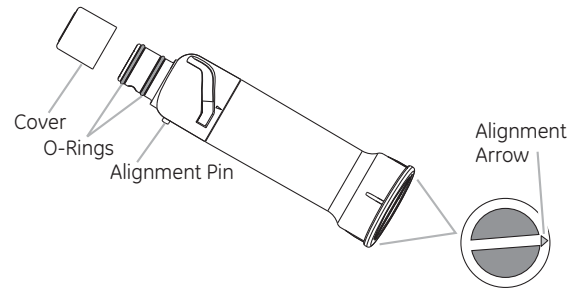

4. Align the pin on the side of the filter with the cutout channel in the filter housing and insert filter.

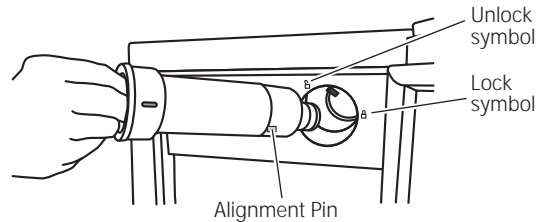

5. Turn filter clockwise until it locks into the housing. Ensure the alignment arrow on the filter head is aligned with the locked symbol on the control box housing.

NOTE: If the filter is not correctly locked into place, the ice maker will not produce ice.

Vacation and moving

To shut down the ice maker:

1. Unplug the ice maker or disconnect power.
2. Remove all ice from the storage bin.
3. Shut off the water supply. If the ambient temperature of the room will drop below 32°F (0°C), water must be removed from the drain line.

For ice makers with a drain pump installed:

1. Plug in ice maker or reconnect power.
2. Turn ice production off and remove all remaining ice from ice bin.

3. Pour 1 gallon (3.78541 L) of water into the ice bin near the drain and let the ice maker stand for approximately 5 minutes. This will allow the water in the bin to drain into the drain pump so the pump will remove the remaining water from the ice bin and drain the pump.
4. Unplug ice maker or disconnect power.

Before using again, clean the ice maker and storage bin. Plug in the ice maker or reconnect power and turn on the water supply to resume ice making operation.

Reverse Osmosis system

IMPORTANT: The performance of the ice maker may be affected when connected to a Reverse Osmosis system. An RO system may also reduce water pressure and affect the fill cycle, which is dependent on time and flow. The reduced water pressure may cause the reservoir not to fill and flush properly during the ice making cycle.

The pressure of the water supply coming out of a reverse osmosis system going to the water inlet valve of the ice maker needs to be between 30 and 120 psi.

If a reverse osmosis water filtration system is connected to your cold water supply, the water pressure to the reverse osmosis system needs to be a minimum of 40 psi. The reverse osmosis system must provide 1 gal. of water per hour to the ice maker for proper ice maker operation.

Do not use copper tubing when the ice maker is connected to a Reverse Osmosis water system.

Normal sounds

Your new ice maker may make sounds that are not familiar to you. Most of the sounds are normal. Hard surfaces such as floors, walls and cabinets can make the sounds seem louder than they actually are. The following describes the kinds of sounds that might be new to you and what may be making them.

- You will hear a buzzing sound when the water valve opens to fill the water pan for each cycle.
- Rattling noises may come from the flow of the refrigerant or the water line. Items stored on top of the ice maker can also make noises.
- The high-efficiency compressor may make a pulsating or high pitched sound.
- Water running over the evaporator plate may make a splashing sound.
- Water running from the evaporator plate to the water pan may make a splashing sound.
- As each cycle ends, you may hear a gurgling sound due to the refrigerant flowing in your ice maker.
- You may hear air being forced over the condenser by the condenser fan.
- During the harvest cycle, you may hear a “thud” when the ice sheet slides from the evaporator onto the cutter grid.
- When you first start the ice maker, you may hear water running continuously. The ice maker is programmed to run a rinse cycle before it begins to make ice.
- If the ice maker is connected to a water supply pressure in excess of 60 psi, you may hear a loud sound during water filling associated with the flow of water through the inlet valve. Call a licensed, qualified plumber to determine the best method to reduce the supply water pressure (50 psi is recommended).

Questions?

Use this problem solver!

Problem	Possible Cause
ON/OFF LED is flashing	This signifies an ice level sensor error. Unplug ice maker and remove the cutter grid cover (see <i>Care and Cleaning – Interior Components</i>). Make sure the white wiring connector going up to the control housing on the right side is connected securely.
Ice maker will not turn on	Check that it is plugged into a grounded 3 prong outlet. Be sure that the control is turned on. See “Using the Controls.” Replace the fuse or reset the circuit breaker. NOTE: If problems continue, contact an electrician. Room temperature must be above 55°F (13°C). Otherwise, bin thermostat may sense cold room temperature and shut off even though the bin is not full of ice. The ice maker may not restart once it does shut off. If there was a large amount of water added to the ice maker, wait a few minutes for the drain pump to clear. If there is still water in the bin, check to see whether the drain hose is kinked. For models with drain pumps, check that the drain hose is not damaged, or kinked or pinched between cabinet and ice maker. Use only GE approved drain pump kit, Part ZPK2.

The Problem Solver

Ice maker

Questions?

Use this
problem
solver!

Problem	Possible Cause
Ice maker seems noisy	<p>Is the water in the water pan overflowing? This is normal. This overflow helps to purge minerals that were removed from the water during the ice making process.</p> <p>Is there a “whooshing” sound? Check the following things:</p> <ul style="list-style-type: none"> ■ Make sure that the water supply is hooked up and turned on. ■ Make sure that the drain cap is tight and the water drain pan pump is securely attached to the water pan. <p>Is there ice between the evaporator plate and the cutting grid? Check that the ice maker is level. See “Leveling.” If the ice maker is level, and the problem persists, run a cleaning cycle. See “Cleaning.”</p> <p>If the ice maker is connected to a water supply pressure in excess of 60 psi, you may hear a loud sound during water filling associated with the flow of water through the inlet valve. Call a licensed, qualified plumber to determine the best method to reduce the supply water pressure (50 psi is recommended).</p>
Ice maker runs but produces no ice	<p>Make sure the control is turned on.</p> <p>Make sure the water supply is properly connected and turned on.</p> <p>If the drain cap is loose, water will empty from the water pan, and you will have either thin ice or no ice. Tighten the drain cap.</p> <p>Clean the drain tube.</p> <p>Be sure that there are no kinks in the drain line.</p>
Ice maker runs but produces very little ice	<p>Is the “QUICK ICE” feature turned on? This feature increases the ice production rate to provide you with more ice in the same amount of time. See <i>Control Settings</i>.</p> <p>Room temperatures of more than 90°F (32°C) will normally reduce ice production.</p> <p>Dirt or lint may be blocking the airflow through the condenser. See <i>Condenser</i> in the <i>Cleaning</i> section.</p> <p>If there is white scale buildup in the interior of the ice maker, you should clean the ice maker. See <i>Interior Components</i> in the <i>Cleaning</i> section.</p> <p>If the drain cap is loose, water will empty from the water pan, and you will have either thin ice or no ice.</p> <p>Tighten the drain cap.</p>
Off taste, odor or gray color in the ice	<p>Is there unusually high mineral content in the water supply? The water may need to be treated or the filter may need to be replaced.</p> <p>Is there mineral scale buildup? Clean your ice maker. See <i>Ice Maker System</i> in the <i>Cleaning</i> section.</p> <p>Do not store any foods in the ice bin. Clean ice storage bin.</p> <p>Make sure that all packaging materials were removed at the time of installation.</p>
Thin, soft or clumps of ice	<p>Is there unusually high mineral content in the water supply? The water may need to be treated or the filter may need to be replaced.</p> <p>Is there mineral scale buildup? Clean your ice maker. See <i>Ice Maker System</i> in the <i>Cleaning</i> section.</p> <p>Are there clumps of ice in the bin? If ice is not used regularly, it will melt and form clumps. Break the clumps with the ice scoop provided.</p>
Water not entering drain properly	<p>Is the drain hose aligned over the drain? Move the ice maker to align with the drain. See <i>Connect Water Supply</i>.</p> <p>NOTE: Service technicians cannot repair plumbing problems outside of the ice maker. Call a licensed, qualified plumber.</p>

With the purchase of your new Monogram appliance, receive the assurance that if you ever need information or assistance from GE, we will be there. All you have to do is call!

GE Answer Center®

***In the USA:
1.800.626.2000***

Whatever your question about any Monogram major appliance, GE Answer Center® information service is available to help. Your call—and your question—will be answered promptly and courteously. You can call any time. GE Answer Center® service is open 24 hours a day, Monday through Saturday.

OR

Visit our Website at: monogram.com

In Canada, call 1.800.561.3344.

In-Home Repair Service

***In the USA:
1.800.444.1845***

***In Canada:
1.800.561.3344***

If your Monogram appliance should ever require service, you can depend on Monogram Preferred Service. Simply call 1.800.444.1845, where our Monogram Preferred Service Specialists are available 7 a.m. - 10 p.m. ET Monday through Friday and 8 a.m. - 6 p.m. ET Saturday and Sunday to coordinate your service appointment. In Canada: Monday to Friday, 7:00 a.m. - 8:00 p.m. and Saturday, 8:00 a.m. - 5:00 p.m. EDST.

For Customers With Special Needs...

***In the USA:
1.800.626.2000***

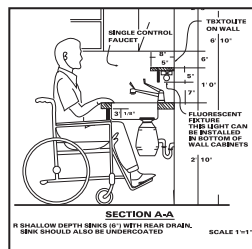

GE offers Braille controls for a variety of GE appliances, and a brochure to assist in planning a barrier-free kitchen for persons with limited mobility.

Consumers with impaired hearing or speech who have access to a TDD or a conventional teletypewriter may call 1.800.TDD.GEAC (1.800.833.4322) to request information or service.

Service Contracts

***In the USA:
1.800.626.2224***

***In Canada:
1.800.561.3344***

You can have the secure feeling that GE Consumer Service will still be there after your warranty expires. Purchase a GE contract while your warranty is still in effect and you'll receive a substantial discount. With a multiple-year contract, you're assured of future service at today's prices.

Parts and Accessories

***In the USA:
1.800.626.2002***

***In Canada:
1.800.561.3344***

Individuals qualified to service their own appliances can have parts or accessories sent directly to their home. The GE parts system provides access to over 47,000 parts, and all GE Genuine Renewal Parts are fully warranted. VISA, MasterCard and Discover cards are accepted. Visit www.geappliances.com

User maintenance instructions contained in this manual cover procedures intended to be performed by any user. Other servicing generally should be referred to qualified service personnel. Caution must be exercised, improper servicing may cause unsafe operation.

YOUR MONOGRAM Ice maker WARRANTY
Staple sales slip or canceled check here. Proof of original purchase date is needed to obtain service under warranty.

WHAT IS COVERED

From the Date of the Original Purchase

LIMITED ONE-YEAR WARRANTY

For one year from date of original purchase, we will provide, free of charge, parts and service labor in your home to repair or replace *any part of the ice maker* that fails because of a manufacturing defect.

LIMITED FIVE-YEAR WARRANTY

For five years from date of original purchase, we will provide, free of charge, parts and service labor in your home to repair or replace *any part of the sealed ice making system* (the compressor, condenser, evaporator and all connecting tubing) that fails because of a manufacturing defect.

This warranty is extended to the original purchaser and any succeeding owner for products purchased for ordinary home use in the 48 mainland states, Hawaii, Washington, D.C. or Canada. If the product is located in an area where service by a GE Authorized Servicer is not available, you may be responsible for a trip charge or you may be required to bring the product to an Authorized GE Service location for service. In Alaska the warranty is the same except that it is LIMITED because you must pay to ship the product to the service shop or for the service technician's travel costs to your home.

All warranty service will be provided by our Factory Service Centers or by our authorized Customer Care® servicers during normal working hours.

Should your appliance need service, during warranty period or beyond, in the USA call 1.800.444.1845. In Canada: 1.800.561.3344. Please have your serial number and model number available when calling for service.

WHAT IS NOT COVERED

- Service trips to your home to teach you how to use the product.
- Replacement of house fuses or resetting of circuit breakers.
- Damage to the product caused by accident, fire, floods or acts of God.
- Failure of the product if it is used for other than its intended purpose or used commercially.
- Damage caused after delivery.
- Improper installation, delivery or maintenance. If you have an installation problem, contact your dealer or installer. You are responsible for providing adequate electrical, plumbing and other connecting facilities.
- Replacement of the light bulbs, if included.
- Incidental or consequential damage caused by possible defects with this appliance.
- Product not accessible to provide required service.

EXCLUSION OF IMPLIED WARRANTIES—Your sole and exclusive remedy is product repair as provided in this Limited Warranty. Any implied warranties, including the implied warranties of merchantability or fitness for a particular purpose, are limited to one year or the shortest period allowed by law.

Some states/provinces do not allow the exclusion or limitation of incidental or consequential damages, so the above limitation or exclusion may not apply to you. This warranty gives you specific legal rights, and you may also have other rights which vary from state to state/province to province. To know what your legal rights are in your state/province, consult your local or state/provincial consumer affairs office or your state's Attorney General.

Warrantor in USA: General Electric Company,
Louisville, KY 40225

Warrantor in Canada: Mabe Canada Inc.

49-60692

224D1893P003 06-13 GE

Printed in the United States



GE Appliances & Lighting
Appliances
General Electric Company
Louisville, KY 40225
GEAppliances.com