



Installation instructions for your new Backguard

JXS80SS

Before you begin – Read these instructions completely and carefully.

IMPORTANT – OBSERVE ALL GOVERNING CODES AND ORDINANCES.

Note to Installer – Be sure to leave these instructions with the Consumer.

Note to Consumer – Keep these instructions with your Owner's Manual for future reference.

TOOLS NEEDED

- 1/4" Hex Driver, 1/4" Open-End Wrench or 1/4" Box Wrench

This kit is used in an installation where the standard 25" deep countertop has a backguard, and the countertop is completely removed to the back wall.

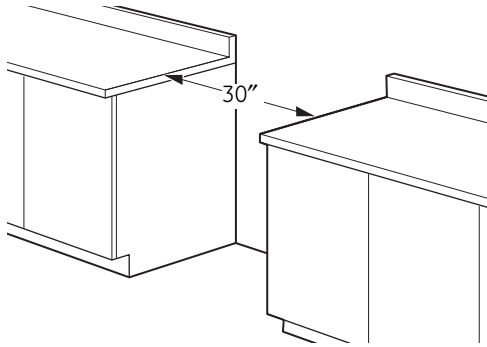

- 1** Remove the protective film that covers the backguard (peel up from corner).

Remove 3 screws (one on each end and one in the middle) holding the vent trim onto the range. Use a 1/4" hex driver. Keep the screws for later use.

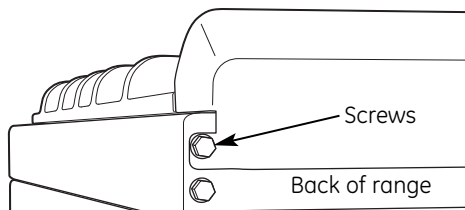

- 2** Remove the vent trim by lifting the rear side and pulling upward.

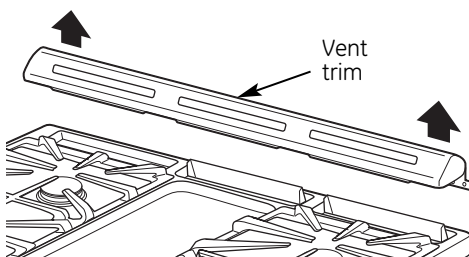

- 3** Take the backguard and hook the front into the large slots in the cooktop. The vent trim was hooked in this same way before you removed it.

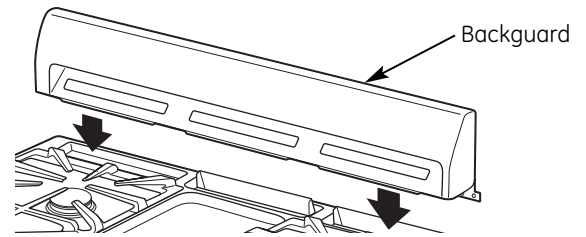

- 4** Rotate the backguard into place. Make sure that the center vent is clear upon installation.

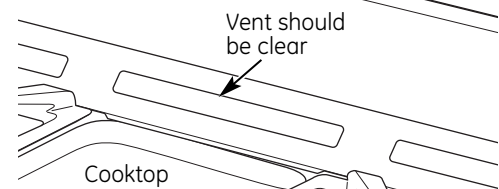

- 5** Attach the backguard to the top of the cooktop using four screws (two on each side).

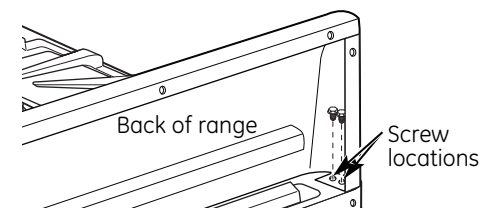

- 6** Slide the backguard panel under the top of the backguard retaining tab. Using the three screws removed earlier and the seven supplied screws, screw down the backguard to the range using the 1/4" hex driver.

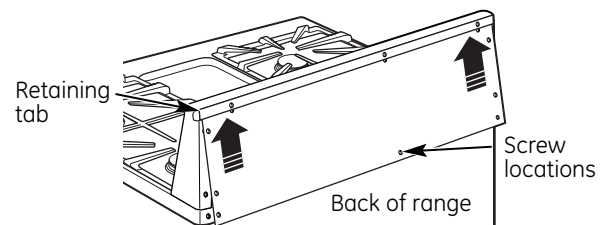

31-21366 (WB36K10694)

08-07 JR

Printed in the United States