

30" GAS COOKTOP
 JGC7530B – 30" x 5¼" x 21"

PRODUCT DIMENSIONS

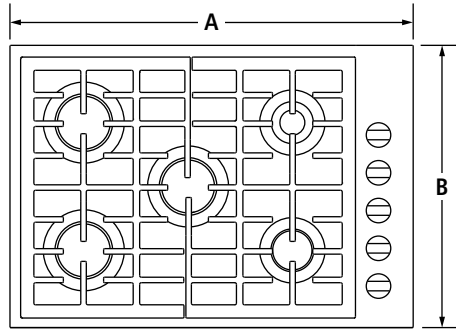

TOP VIEW

| MODEL # | | JGC7530B | |
|----------|--|----------|------|
| | | in | cm |
| A | Overall width | 30 | 76.2 |
| B | Overall depth | 21 | 53.3 |
| C | Center of cooktop to center of gas inlet | 12 | 30.5 |
| D | Width of recessed cooktop | 29¼ | 74.3 |
| E | Height of recessed cooktop | ¾ | 8.3 |
| F | Height from gas inlet to countertop | 5¼ | 13.3 |
| G | Height with grates | 1¼ | 3.2 |
| H | Depth of recessed cooktop | 20¼ | 51.4 |

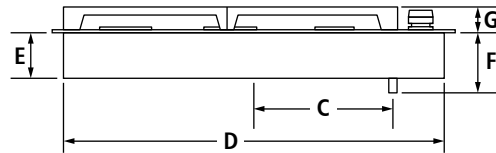

FRONT VIEW

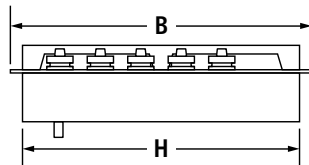

SIDE VIEW

30" GAS COOKTOP
JGC7530B – 30" x 5¼" x 21"

OPENING/CLEARANCE DIMENSIONS

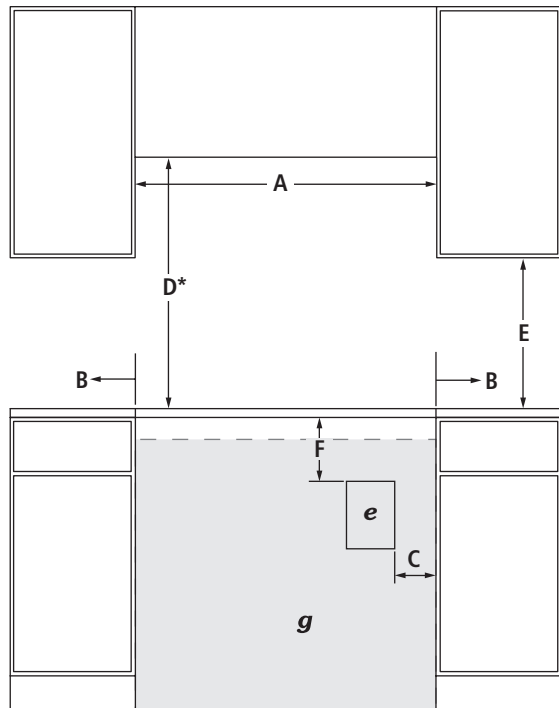

FRONT VIEW

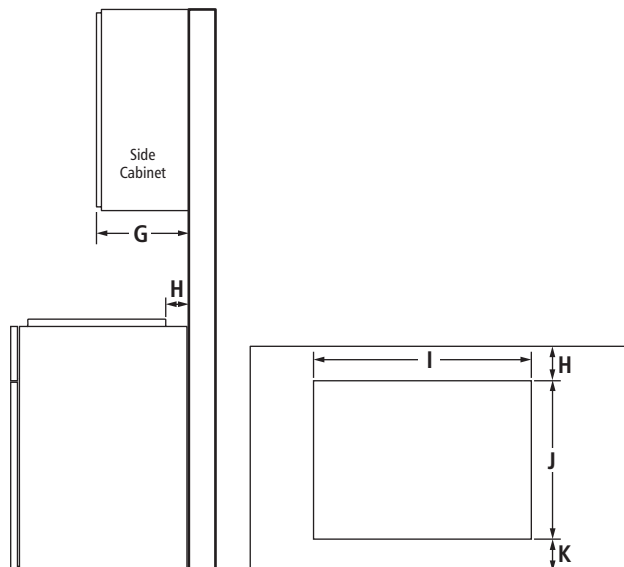

SIDE VIEW

TOP VIEW – CUTOUT

| MODEL # | | JGC7530B | |
|-----------|--|----------|------|
| | | in | cm |
| A | Width of combustible area above cooking surface (min.) | 30 | 76.2 |
| B | Width from cooktop to fixed wall or other combustible material (min.) | 6 | 15.2 |
| C | Width to outer edge of outlet (max.) | 24 | 61.0 |
| D* | Height to bottom of uncovered wood or metal cabinet above cooking surface (min.) | 30 | 76.2 |
| E | Height to bottom of uncovered wood or metal cabinet (min.) | 18 | 45.7 |
| F | Height to top edge of outlet (min.) | 5½ | 14.0 |
| G | Depth of upper cabinet (recommended) | 13 | 33.0 |
| H | Depth from cutout to wall (min.) | 2⅝ | 5.9 |
| I | Width of cutout | 29⅜ | 74.6 |
| J | Depth of cutout | 20⅜ | 51.8 |
| K | Depth from cutout to front of countertop | 2⅝ | 5.9 |
| e | Recommended electrical access location | | |
| g | Recommended gas supply line location | | |

*Dimension can be reduced by 6" (15.2 cm) when bottom of wood or metal cabinet is covered by not less than ¼" (0.6 cm) flame retardant millboard covered with not less than No. 28 MSG sheet metal, 0.015" (0.4 mm) stainless steel, 0.024" (0.6 mm) aluminum or 0.020" (0.5 mm) copper.

If installing a hood or microwave hood combination above the cooktop, follow the hood or microwave hood combination instructions for dimensional clearances above the cooking surface.

GAS REQUIREMENTS

Natural Gas

This cooktop is factory-set for use with natural gas.

LP Gas Conversion

Conversion must be done by a qualified service technician. To convert to LP gas, use the LP gas conversion kit provided with the cooktop.

ELECTRICAL REQUIREMENTS

120 volt, 60 Hz, AC only, 15-amp fused, electrical circuit is required. A time-delay fuse or dedicated circuit is recommended.

LOCATION REQUIREMENTS

- To ensure cooktop base clearance, cabinet side walls need to be wider than the cutout.
- If cabinet has a drawer, allow a 4" (10.2 cm) minimum clearance between countertop and top of drawer. Drawer depth may need to be shortened to avoid interfering with the regulator.

SINGLE WALL OVEN AND COOKTOP COMBINATIONS

APPROVED MODEL NUMBER COMBINATIONS

SINGLE WALL OVENS

30-Inch: JJW3430W, JJW2430W, JJW2330W

27-Inch: JJW2427W, JJW2327W

INDUCTION COOKTOPS

36-Inch: JIC4536X

30-Inch: JIC4430X

GAS COOKTOPS

36-Inch: JGC7636B, JGC9536BD, JGC1536AD, JGC8536BD

30-Inch: JGC7530B, JGC9430BD, JGC1430AD

ELECTRIC COOKTOPS

36-Inch: JEC4536B, JEC3536B

30-Inch: JEC4430B, JEC3430B

OPENING/CLEARANCE DIMENSIONS

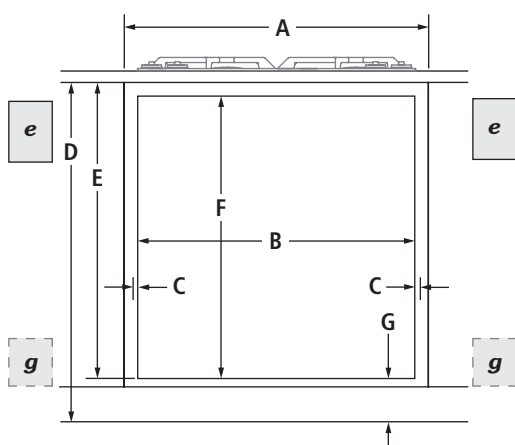

**FRONT VIEW –
UNDER COUNTER INSTALLATION**
(with cooktop installed above)

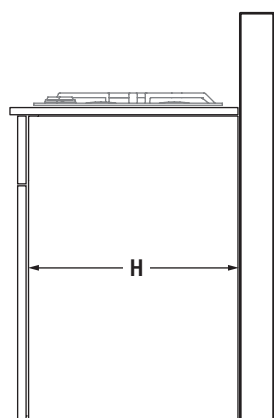

**SIDE VIEW –
UNDER COUNTER INSTALLATION**
(with cooktop installed above)

| MODEL # | JJW3430W JJW2430W JJW2330W | | JJW2427W JJW2327W | | | |
|----------|--|----|----------------------|------|-----|------|
| | in | cm | in | cm | | |
| A | Width of cabinet (min.) | | 30 | 76.2 | 27 | 68.6 |
| B | Width of cutout (recommended) | | 28½ | 72.4 | 25½ | 64.8 |
| C | Oven trim overlap | | ⅝ | 1.6 | ⅝ | 1.6 |
| D | Bottom of countertop to floor | | 34½ | 87.6 | 34½ | 87.6 |
| E | Bottom of countertop to bottom of cutout | | | | | |
| | Induction cooktop combination | | 30⅞ | 78.4 | 30⅞ | 78.4 |
| | Gas cooktop combination | | 29⅞ | 75.9 | 29⅞ | 75.9 |
| | Electric cooktop combination | | 29⅞ | 75.9 | 29⅞ | 75.9 |
| F | Height of cutout (recommended) | | 27¾ | 70.5 | 27¾ | 70.5 |
| G | Bottom of cutout to floor | | | | | |
| | Induction cooktop combination | | 3⅝ | 9.2 | 3⅝ | 9.2 |
| | Gas cooktop combination | | 4⅝ | 11.7 | 4⅝ | 11.7 |
| | Electric cooktop combination | | 4⅝ | 11.7 | 4⅝ | 11.7 |
| H | Depth of cabinet (min.) | | 24 | 61.0 | 24 | 61.0 |
| e | Recommended junction box location | | | | | |
| g | Recommended gas supply line location for gas cooktop | | | | | |

NOTE: For under counter installation, the junction box should be located in the adjacent right or left cabinet. Drill a 1" (2.5 cm) minimum diameter hole in an upper corner of the side wall for access to the junction box.

CABINET REQUIREMENTS

NOTE: When using under counter installation, check cabinet manufacturer's specifications to verify fit.

JENN-AIR® DETAILED PLANNING DIMENSIONS

VENTILATION SELECTION CHART – COOKTOPS

| MODEL # | ACCOLADE™ DOWNDRAFT SYSTEM | TELESCOPING DOWNDRAFT SYSTEM | | PRO-STYLE™ HOODS | | | EURO-STYLE ISLAND-MOUNT HOODS | | EURO-STYLE WALL-MOUNT HOODS | | GLASS COLLECTION ISLAND-MOUNT HOOD | GLASS COLLECTION WALL-MOUNT HOODS | | PERIMETRIC HOOD | CUSTOM HOOD LINERS | OVER-THE- RANGE MICROWAVE OVENS |
|---|----------------------------------|---------------------------------|-----------|------------------|------------------------|------------------------|----------------------------------|-----------|--------------------------------|-----------|---|--------------------------------------|-----------|--------------------|--|--|
| | JXD7836B | JXD7036YS | JXD7030YS | JXW9048WP | JXW9036WP JXU9136WP | JXW9030WP JXU9130WP | JXI8042WS | JXI8036WS | JXW8036WS JXW8836WS | JXW8030WS | JXI5036WS | JXW5036WS | JXW5030WS | JXP5032WS | UXL6048YSS ^A UXL6036YSS ^A | JMV9186W JMV8208W |
| INDUCTION COOKTOPS | | | | | | | | | | | | | | | | |
| 36-INCH | | | | | | | | | | | | | | | | |
| JIC4536X – 5 Elements | ■ | ■ | — | ■ | ■ | — | ■ | ■ | ■ | — | ■ | ■ | — | ■ | ■ | ■ |
| 30-INCH | | | | | | | | | | | | | | | | |
| JIC4430X – 4 Elements | ■ | ■ | ■ | ■ | ■ | ■ | ■ | ■ | ■ | ■ | ■ | ■ | ■ | ■ | ■ | ■ |
| CONVENTIONAL GAS COOKTOPS | | | | | | | | | | | | | | | | |
| 36-INCH (60,000 BTU total or more) | | | | | | | | | | | | | | | | |
| JGC7636B – 6 Burners | ■ | — | — | ■ | ■ | — | — | — | — | — | — | — | — | — | 1,200 CFM only | — |
| 36-INCH (less than 60,000 BTU total) | | | | | | | | | | | | | | | | |
| JGC9536BD – 5 Burners | ■ | ■ | — | ■ | ■ | — | ■ | ■ | ■ | — | ■ | ■ | — | ■ | ■ | ■ |
| JGC1536AD – 5 Burners | ■ | ■ | — | ■ | ■ | — | ■ | ■ | ■ | — | ■ | ■ | — | ■ | ■ | ■ |
| JGC8536BD – 5 Burners | ■ | ■ | — | ■ | ■ | — | ■ | ■ | ■ | — | ■ | ■ | — | ■ | ■ | ■ |
| 30-INCH (60,000 BTU total or more) | | | | | | | | | | | | | | | | |
| JGC7530B – 5 Burners | ■ | ■ | ■ | ■ | ■ | ■ | ■ | ■ | ■ | ■ | ■ | ■ | ■ | ■ | ■ | — |
| 30-INCH (less than 60,000 BTU total) | | | | | | | | | | | | | | | | |
| JGC9430BD – 4 Burners | ■ | ■ | ■ | ■ | ■ | ■ | ■ | ■ | ■ | ■ | ■ | ■ | ■ | ■ | ■ | ■ |
| JGC1430AD – 4 Burners | ■ | ■ | ■ | ■ | ■ | ■ | ■ | ■ | ■ | ■ | ■ | ■ | ■ | ■ | ■ | ■ |
| CONVENTIONAL ELECTRIC COOKTOPS | | | | | | | | | | | | | | | | |
| 36-INCH | | | | | | | | | | | | | | | | |
| JEC4536B – 5 Elements | ■ | ■ | — | ■ | ■ | — | ■ | ■ | ■ | — | ■ | ■ | — | ■ | ■ | ■ |
| JEC3536B – 5 Elements | ■ | ■ | — | ■ | ■ | — | ■ | ■ | ■ | — | ■ | ■ | — | ■ | ■ | ■ |
| 30-INCH | | | | | | | | | | | | | | | | |
| JEC4430B – 4 Elements | ■ | ■ | ■ | ■ | ■ | ■ | ■ | ■ | ■ | ■ | ■ | ■ | ■ | ■ | ■ | ■ |
| JEC3430B – 4 Elements | ■ | ■ | ■ | ■ | ■ | ■ | ■ | ■ | ■ | ■ | ■ | ■ | ■ | ■ | ■ | ■ |

A. Custom hood liners can be used with any of the following blower motors: UXB1200DYS, UXB0600DYS or UXI1200DYS.

| KEY | |
|-----|-----------------|
| ■ | Recommended |
| — | Not Recommended |

Product dimension, cutout and installation specifications are provided for planning purposes only. Before installing any product, be sure to verify cutout dimensions and electrical/gas connections as actual product dimensions may vary.

