

This Data Sheet Includes Information On

Jenn-Air

- Product Model Number (s):
30" Undercounter or Wall Ovens:
JJW9530DDB, JJW9530DDQ, JJW9530DDS and
JJW9530DDW

Dimensions (Actual Size)

- Cutout width: 28 1/2"
 - Cutout height: 29 1/16"
 - Minimum cabinet width: 30"
 - Minimum cabinet depth: 24"
 - Recommended cutout location from floor : 4" to 31"
 - Distance from face of cabinet to outer edge of open door (Door swing): 21"
 - Distance from face of cabinet to front of closed door handle: 3 7/8"
 - Overall unit width: 29 3/4"
 - Overall unit height: 29 1/2"
 - Penetration into cabinet: 24"
- Oven overlap distances when using cutout dimensions listed above:
- Top overlap: 1/4"
 - Bottom overlap: 1/8"
 - Right side overlap: 5/8"
 - Left side overlap: 5/8"

Additional Information

- Total connected load: 3.6KW @120/240v. 3 wire single phase, 60Hz. 20 amp circuit recommended.
- A complete floor is recommended to prevent unusual drafts and capable of supporting 142 lbs.
- Minimum distance from bottom of opening to any object protruding from cabinet face (i.e. cabinet door) directly below: 7/8" (because it is an air flow area)

SEE PAGE 2 FOR UNDERCOUNTER INSTALLATION

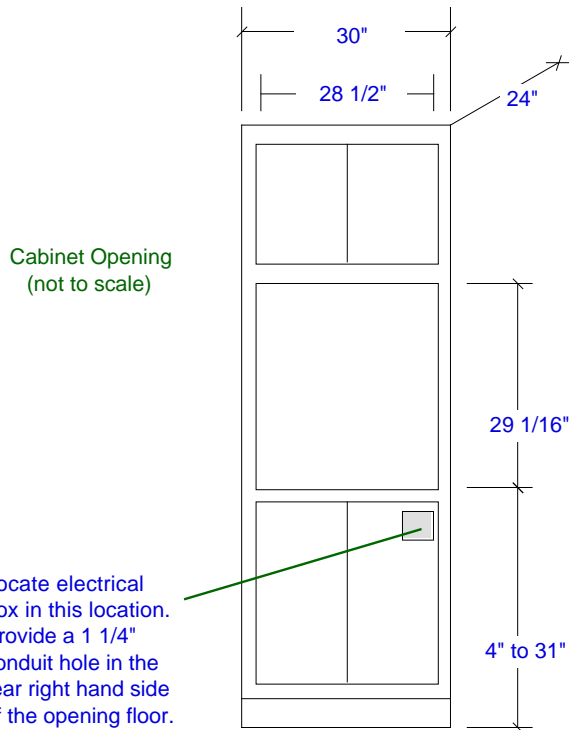

Overall Dimensions (not to scale)

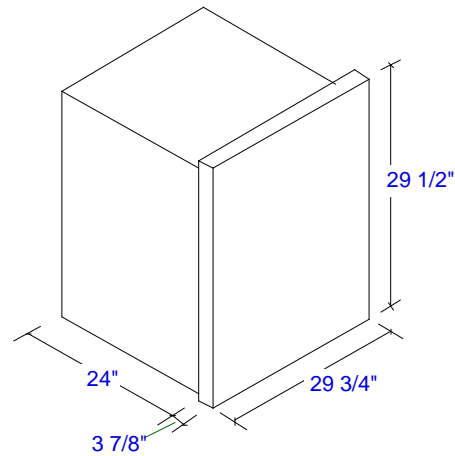

Subject to change without notice. This system is designed to be updated daily if necessary. Dimension Express is not responsible for use of superseded, voided, or outdated data sheets. Because of the difficulty or impracticability of determining actual damages, liability of Dimension Express shall not exceed \$50.00.

Copyright © Dimension Express, 2003.

• NEVER reuse Data Sheets. Data Sheets are subject to change without notice. Dimension Express is a FREE service bureau and is updated daily, it makes far more sense to spend the time necessary to request new Data Sheets for each project, as opposed to the problems, time, costs, and risks associated with reusing old Data Sheets.

- Call Dimension Express if you have any questions at (775) 833-3633 •
- Always refer to a current Code at a Glance or manufacturer directory •
- Data Sheet codes change on the first of odd numbered months at 12:01am •

BN207.5 • A214B149 • 031211 • 8494 • 53217

Product Model Number (s):
 30" Undercounter or Wall Ovens:
 JJW9530DDB, JJW9530DDQ, JJW9530DDS and
 JJW9530DDW

Additional Information:

- If you are stacking two units: Maximum distance from floor to bottom of lower oven opening is 7 1/2". Minimum distance from top of lower oven opening to bottom of upper oven opening is 1".
- House wire to enter junction box at left side. Range wires to enter right side of junction box.
- See below for undercounter installation.

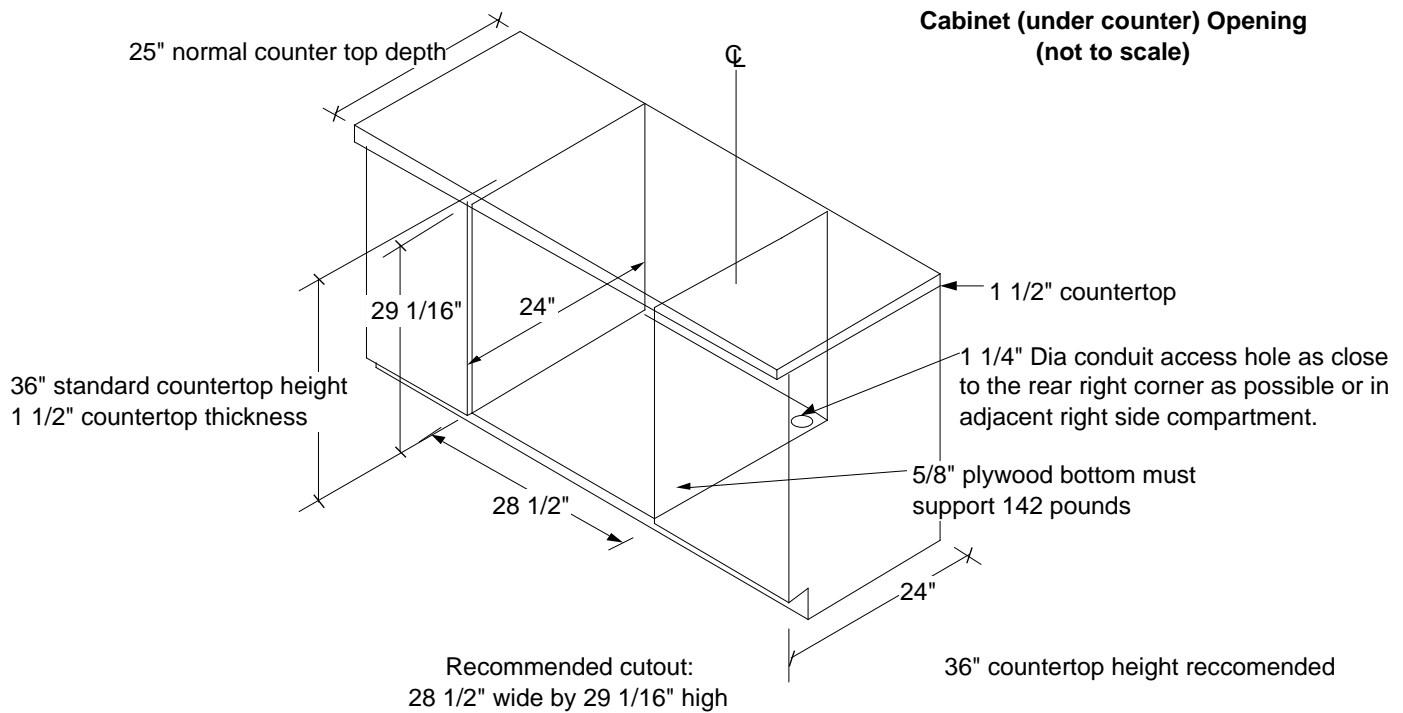

Subject to change without notice. This system is designed to be updated daily if necessary. Dimension Express is not responsible for use of superseded, voided, or outdated data sheets. Because of the difficulty or impracticability of determining actual damages, liability of Dimension Express shall not exceed \$50.00. Copyright © Dimension Express, 2003.

• NEVER reuse Data Sheets. Data Sheets are subject to change without notice. Dimension Express is a FREE service bureau and is updated daily, it makes far more sense to spend the time necessary to request new Data Sheets for each project, as opposed to the problems, time, costs, and risks associated with reusing old Data Sheets.

- Call Dimension Express if you have any questions at (775) 833-3633 •
- Always refer to a current Code at a Glance or manufacturer directory •
- Data Sheet codes change on the first of odd numbered months at 12:01am •