



OWNER'S MANUAL & COOKING GUIDE

MICROWAVE OVEN

PLEASE READ THIS OWNER'S MANUAL
THOROUGHLY BEFORE OPERATING

LMVH1711ST



MFL37191406_07

www.lg.com

Thank you for purchasing an LG microwave oven.

Please record the model number and serial number of this unit for future reference. We also suggest you record the details of your contact with LG (LG Electronics U.S.A., Inc.) concerning this unit.

Model No: _____

Serial No: _____

Dealer: _____

Dealer Phone No: _____

Staple your receipt here to prove your retail purchase.

Customer Relations
LG Electronics U.S.A., Inc.
Service Division Bldg. #3
201 James Record Rd.
Huntsville, AL 35824-0126

PRECAUTIONS TO AVOID POSSIBLE EXPOSURE TO EXCESSIVE MICROWAVE ENERGY...

- (a) Do not attempt to operate this oven with the door open since open-door operation can result in harmful exposure to microwave energy. It is important not to defeat or tamper with the safety interlocks.
- (b) Do not place any object between the oven front face and the door or allow soil or cleaner residue to accumulate on sealing surfaces.
- (c) Do not operate the oven if it is damaged. It is particularly important that the oven door closes properly and that there is no damage to the:
 - (1) Door (bent),
 - (2) Hinges and latches (broken or loosened),
 - (3) Door seals and sealing surfaces.
- (d) The oven should not be adjusted or repaired by anyone except properly qualified service personnel.

TABLE OF CONTENTS

PRECAUTIONS TO AVOID POSSIBLE EXPOSURE TO EXCESSIVE MICROWAVE ENERGY	2	Auto Defrost Table	22
TABLE OF CONTENTS	3	Defrosting Tips	24
SAFETY	4	Sensor Operating Instructions.....	25
Important Safety Instructions	4	Sensor Cooking Guide	25
INFORMATION	6	Sensor Cook	25
Location of Model Number	6	Sensor Reheat	25
Oven Specifications	6	Sensor Popcorn	25
Electrical Requirements	6	Sensor Cook Table	26
Grounding Instructions	6	Sensor Reheat Table	26
Microwave Oven Features	7	Auto Cook	27
Control Panel Features	8	Auto Cook Table	27
MICROWAVE COOKING TIPS	10	Tips for Convection Cooking	28
OPERATION	15	Convection	29
Learn About Your Microwave Oven	15	Tips for Combination Cooking.....	30
Clock	15	Helpful Hints for Combination Cooking	30
Child Lock	15	Combination Roast.....	30
Timer	16	Speed Auto Combination	31
Custom Cook	16	Speed Auto Combination Chart	31
Vent Fan	16	COOKING	32
Vent Fan Auto Time Set	16	Convection Baking Guidelines	32
Ez-ON	16	Meat Roasting Guidelines for Convection	
Turntable On/Off	17	Cooking	34
Light On/Off.....	17	Combination Roast Cooking Guide.....	35
More/Less	17	Combination Bake Cooking Guide	36
Custom Set	17	Heating/Reheating Guide.....	37
Cooking at High Power Level.....	17	Fresh Vegetable Guide	38
Cooking at Lower Power Levels	18	MAINTENANCE	39
Cooking With More Than One Cook Cycle	18	Caring for Your Microwave Oven	39
Cooking Guide for Lower Power Levels.....	19	Cleaning the Grease Filters	40
Soften	20	Charcoal Filter Replacement.....	40
Soften Table	20	Cooktop/Countertop Light Replacement.....	41
Melt	20	Oven Light Replacement.....	41
Melt Table	20	Questions and Answers	41
Auto Defrost	21	Microwave Utensil Guide	42
Weight Conversion Table	21	TROUBLESHOOTING	43
Operating Tips	21	Before Calling for Service	43
		WARRANTY	Inside Back Cover

SAFETY

IMPORTANT SAFETY INSTRUCTIONS

The safety instructions below will tell you how to use your oven and avoid harm to yourself or damage to your oven.

⚠ WARNING - To reduce the risk of burns, electric shock, fire, injury to persons, or exposure to excessive microwave energy:

- **Read all the instructions before using your oven.**
- **Do not allow children to use this oven without close supervision.**
- Read and follow the specific **PRECAUTIONS TO AVOID POSSIBLE EXPOSURE TO EXCESSIVE MICROWAVE ENERGY** found on page 2.
- **Do not use** corrosive chemicals or vapors, such as sulfide and chloride, in this appliance. This type of oven is specifically designed to heat, cook, or dry food. It is not designed for industrial or laboratory use.
- **Do not store** this appliance outdoors. Do not use this product near water - for example, near a kitchen sink, in a wet basement, near a swimming pool, or similar location.
- **Do not use** the cavity for storage purposes. Do not leave paper products, cooking utensils, or food in the cavity when not in use.
- **Clean the ventilating hood frequently.** Do not allow grease to accumulate on the hood or the filters.
- Use care when cleaning the vent hood filters. Corrosive cleaning agents, such as lye-based oven cleaners, may damage the filters.
- **Do not tamper with the built-in safety switches on the oven door.** The oven has several built-in safety switches to make sure the power is off when the door is open.
- When cooking foods under the hood, turn the fan on.
- Suitable for use above both gas and electric cooking equipment 36 inches wide or less.
- **Do not use this oven for commercial purposes.** It is made for household use only.
- **When cleaning the door and the surfaces that touch the door, use only mild, non-abrasive soaps or detergents and a sponge or soft cloth.**
- **If your oven is dropped or damaged,** have it thoroughly checked by a qualified service technician before using it again.
- **To reduce the risk of fire in the oven cavity:**
 - **Do not overcook food.** Carefully attend to the microwave oven when paper, plastic or other combustible materials are placed inside the oven to facilitate cooking.
 - **Do not use the cavity for storage purposes.** Do not leave paper products, cooking utensils or food in the cavity when not in use.
 - Remove wire twist-ties from paper or plastic bags before placing bags in oven.
- **If materials inside the oven ignite:**
 - **Keep oven door closed**
 - **Turn the oven off**
 - **Disconnect the power cord or shut off power at the fuse or circuit breaker panel**
- **To avoid electric shock:**
 - **This appliance must be grounded.** Connect only to a properly grounded outlet. See the electrical **GROUNDING INSTRUCTIONS** on page 6.
 - **Do not operate this appliance if it has a damaged cord or plug,** if it is not working properly or if it has been damaged or dropped.
 - **Do not immerse the electrical cord or plug in water.**
 - **Keep the cord away from heated surfaces.**
- **Take care when the door is opened to avoid injury.**

SAFETY

- **To avoid improperly cooking some foods.**
 - **Do not heat any types of baby bottles or baby food.** Uneven heating may occur and possibly cause personal injury.
 - **Do not heat small-necked containers**, such as syrup bottles.
 - **Do not deep-fat fry in your microwave oven.**
 - **Do not attempt home canning in your microwave oven.**
 - **Do not heat the following items in the microwave oven:** whole eggs in the shell, water with oil or fat, sealed containers, or closed glass jars. These items may explode.
 - Do not cover or block any openings in the oven.
 - Use your oven only for the operations described in this manual.
 - Do not run the oven empty.
 - Secure power cord in the cabinet above the oven.
 - **Preserve the oven floor:**
 - **Do not heat the oven floor excessively.**
 - **Do not** allow the gray film on special microwave-cooking packages to touch the oven floor. Put the package on a microwavable dish.
 - **Do not** cook anything directly on the oven floor or turntable. Use a microwavable dish.
 - Keep a browning dish at least 3/16 inch above floor. Carefully read and follow the instructions for the browning dish. If you use a browning dish incorrectly, you could damage the oven floor.
 - Install or locate this appliance only in accordance with the provided installation instructions.
 - This appliance should be serviced only by qualified service personnel. Contact the nearest authorized service facility for examination, repair, or adjustment.
 - Liquids, such as water, coffee, or tea can be overheated beyond the boiling point without appearing to be boiling due to surface tension of the liquid. Visible bubbling or boiling when the container is removed from the microwave oven is not always present.
THIS COULD RESULT IN VERY HOT LIQUIDS SUDDENLY BOILING OVER WHEN THE CONTAINER IS DISTURBED OR A SPOON OR OTHER UTENSIL IS INSERTED INTO THE LIQUID.
- To reduce the risk of injury to persons;
- Do not overheat the liquid.
 - Stir the liquid both before and halfway through heating it.
 - Do not use straight-sided containers with narrow necks.
 - After heating, allow the container to stand in the microwave oven for a short time before removing the container.
 - Use extreme care when inserting a spoon or other utensil into the container.

SAVE THESE INSTRUCTIONS

FEDERAL COMMUNICATIONS COMMISSION RADIO FREQUENCY INTERFERENCE STATEMENT (U.S.A. ONLY)

WARNING:

This equipment generates and uses ISM frequency energy and if not installed and used properly, that is in strict accordance with the manufacturer's instructions, may cause interference to radio and television reception. It has been type tested and found to comply with limits for ISM Equipment pursuant to part 18 of FCC Rules, which are designed to provide reasonable protection against such interference in a residential installation.

However, there is no guarantee that interference will not occur in a particular installation. If this equipment does cause interference to radio or television reception, which can be determined by turning the equipment off and on, the user is encouraged to try to correct the interference by one or more of the following:

- Reorient the receiving antenna of the radio or television.
- Relocate the Microwave Oven with respect to the receiver.
- Move the microwave oven away from the receiver.
- Plug the microwave oven into a different outlet so that the microwave oven and the receiver are on different branch circuits.

The manufacturer is not responsible for any radio or TV interference caused by **unauthorized modification** to this microwave oven. It is the responsibility of the user to correct such interference.

 **WARNING:** This product contains chemicals known to the State of California to cause cancer. ***Wash hands after handling.***

INFORMATION

Please read this owner's manual. It will tell you how to use all the fine features of this microwave oven.

LOCATION OF MODEL NUMBER

To request service information or replacement parts, the service center will require the complete model number of your microwave oven. The model number is on the oven front as shown in the illustration below.

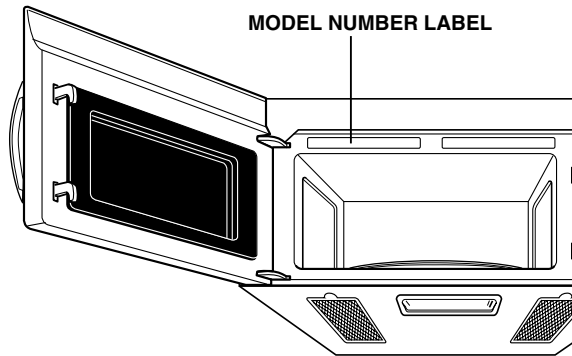

OVEN SPECIFICATIONS

Power Supply	120V AC, 60 Hz	
Rated Power	Microwave	1600W
Consumption	Convection	1700W
Power Output	Microwave	950W
	Convection	1500W
Rated Current	Microwave	13.5A
	Convection	14.0A
Overall Dimensions(WxHxD)	29 ¹⁵ / ₁₆ " x 16 ⁷ / ₁₆ " x 15 ³ / ₈ "	
Oven Cavity Dimensions (WxHxD)	21 ¹ / ₄ " x 9 ⁷ / ₁₆ " x 14 ³ / ₁₆ "	
Capacity of Oven Cavity	1.7 cu.ft	

ELECTRICAL REQUIREMENTS

The oven is designed to operate on a Standard 120V/60Hz household outlet. Be sure the circuit is at least 15A or 20A and the microwave oven is the **only appliance on the circuit**. It is not designed for 50Hz or any circuit other than a 120 V/60 Hz circuit.

GROUNDING INSTRUCTIONS

The microwave oven must be grounded. In the event of an electrical short circuit, grounding reduces the risk of electric shock by providing an escape wire for the electric current. The microwave oven is equipped with a cord having a grounding wire with a grounding plug. The plug must be plugged into an outlet that is properly installed and grounded.

⚠ WARNING - Improper grounding can result in a risk of electric shock.

Consult a qualified electrician if you do not understand the grounding instructions or if you wonder whether the appliance is properly grounded.

Because this appliance fits under the cabinet, it has a short power-supply cord. See the separate Installation Instructions for directions on placing the cord properly.

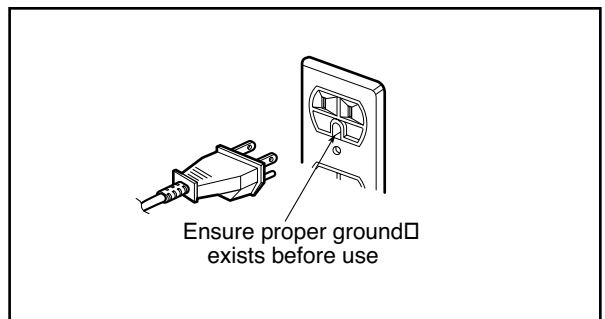

Keep the electrical power cord dry and do not pinch or crush it in any way.

INFORMATION

MICROWAVE OVEN FEATURES

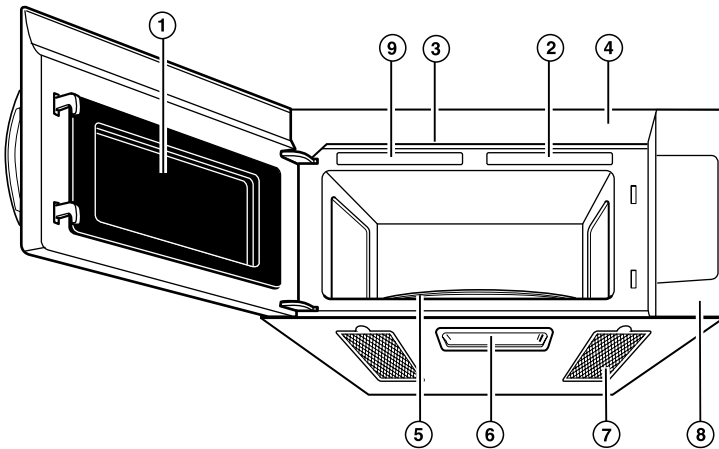

Your microwave oven is designed to make your cooking experience as enjoyable and productive as possible. To get you up and running quickly, the following is a list of the oven's basic features:

- 1. Metal Shielded Window** The shield prevents microwaves from escaping. It is designed as a screen to allow you to view food as it cooks.
- 2. Cooking Guide Label**
- 3. Charcoal Filter** (behind Vent Grille)
- 4. Vent Grille**
- 5. Glass Tray** The glass tray moves food as it cooks for more even cooking. It must be in the oven during operation.
- 6. Cooktop Light**
- 7. Grease Filter**
- 8. Control Panel** Touch the pads on this panel to perform all functions.
- 9. Model and Serial Number Plate**

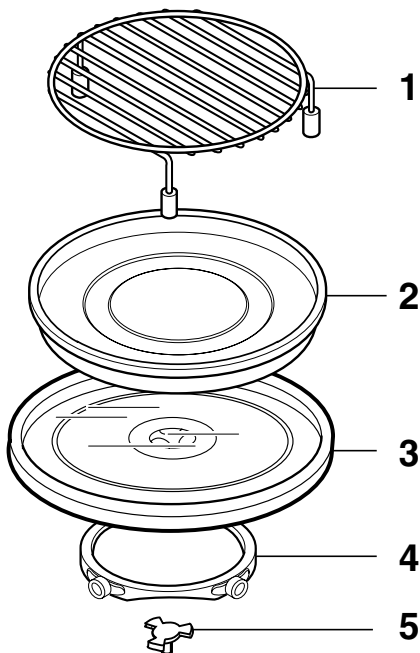

The turntable rotates in both direction to help food cook more evenly. Do not operate the microwave oven without the glass tray in place.

- 1. Convection Rack**
- 2. Metal Tray/Drip Pan**
- 3. Turntable**
- 4. Rotating Ring**
- 5. Shaft**

INFORMATION

CONTROL PANEL FEATURES

Your microwave oven control panel lets you select the desired cooking function quickly and easily. All you have to do is touch the necessary Command Pad. The following is a list of all the Command and Number Pads located on the control panel. **For more information on these features, see OPERATION section.**

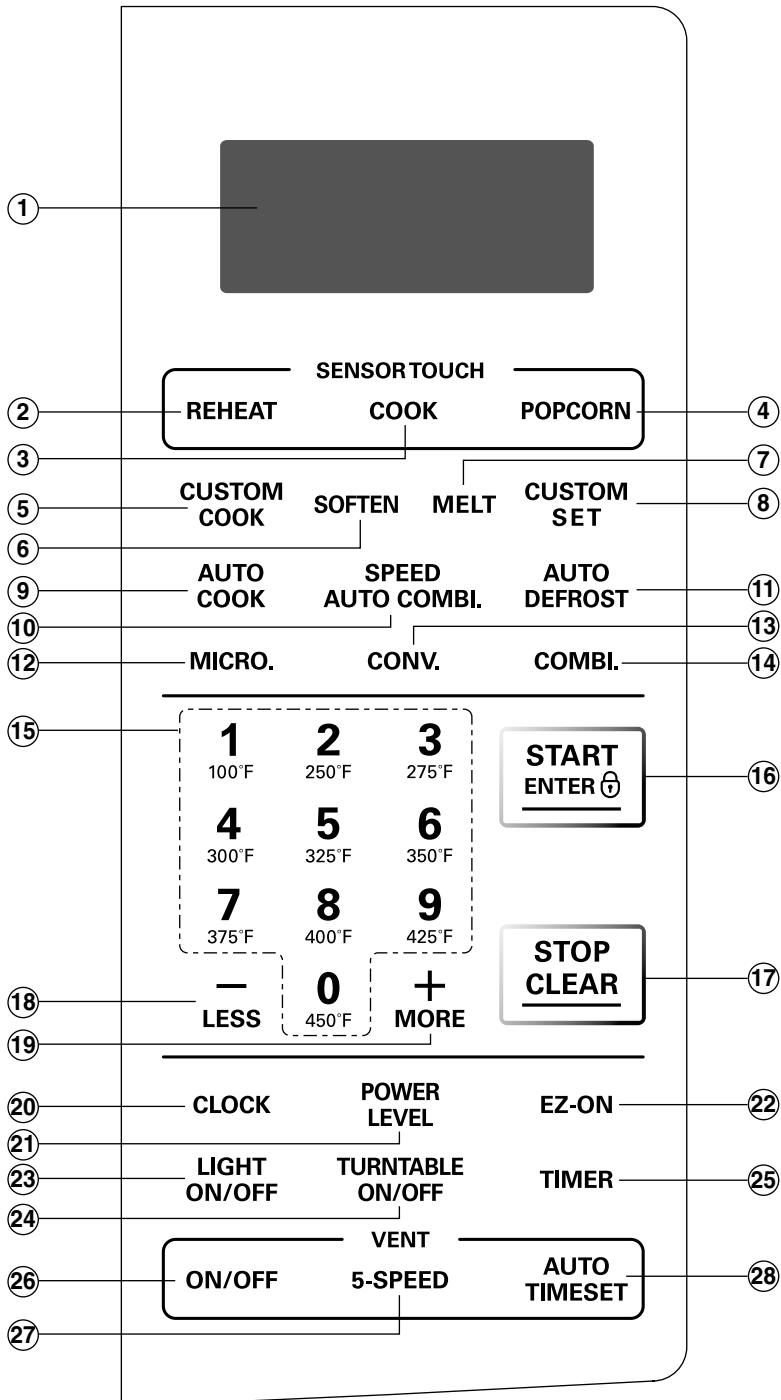

INFORMATION

- 1. DISPLAY:** The Display includes a clock and indicators to tell you time of day, cooking time settings, and cooking functions selected.
- 2. SENSOR REHEAT:** Touch this pad to reheat casserole, dinner plate, pizza slice, and soup/sauce. The oven's sensor will tell the oven how long to cook depending on the amount of humidity coming from the food.
- 3. SENSOR COOK:** Touch this pad to cook baked potato, frozen vegetable, fresh vegetable, canned vegetable, frozen entrée, and rice. The oven's sensor will tell the oven how long to cook depending on the amount of humidity coming from the food.
- 4. SENSOR POPCORN:** Touch this pad when popping popcorn in your microwave oven. The oven's sensor will tell the oven how long to cook depending on the amount of humidity it detects from the popcorn.
- 5. CUSTOM COOK:** Touch this pad to recall one cooking instruction previously programmed into memory.
- 6. SOFTEN:** Touch this pad to soften Butter, Ice Cream, Cream Cheese, or Frozen Juice.
- 7. MELT:** Touch this pad to melt Butter or Margarine, Chocolate, Cheese, or Marshmallow.
- 8. CUSTOM SET:** Touch this pad to change the oven's default settings for sound, clock, display speed, and defrost weight.
- 9. AUTO COOK:** Touch this pad to cook Bacon, Fresh Roll & Muffin, Frozen Roll & Muffin, Beverage, Chicken Pieces, and Hot Cereal.
- 10. SPEED AUTO COMBI:** Touch this pad when setting weight combination cooking.
- 11. AUTO DEFROST:** Touch this pad to select food type and defrost food by weight.
- 12. MICRO.:** Touch this pad when setting Microwave cooking.
- 13. CONV.:** Touch this pad when setting Convection cooking.
- 14. COMBI.:** Touch this pad when setting combination cooking or preheat.
- 15. NUMBER:** Touch number pads to enter cooking time, power level, quantities, weights, or cooking temperature.
- 16. START/ENTER:** Touch this pad to start a function or enter all entries. If you open the door after oven begins to cook, touch START/ENTER again.
- 17. STOP/CLEAR:** Touch this pad to stop the oven or to clear all entries.
- 18. LESS:** Touch this pad to subtract ten seconds of cooking time each time you press it.
- 19. MORE:** Touch this pad to add ten seconds of cooking time each time you press it.
- 20. CLOCK:** Touch this pad to enter the time of day.
- 21. POWER LEVEL:** Touch this pad to select a cooking power level.
- 22. EZ-ON:** Touch this pad to set and start at 100% power level on microwave cooking.
- 23. LIGHT ON/OFF:** Touch this pad to turn the cooktop/ countertop light on or off.
- 24. TURNTABLE ON/OFF:** Touch this pad to turn off the turntable. OFF will appear in the display.
NOTE: This option is not available in sensor cook and defrost modes.
- 25. TIMER:** Touch this pad to set the timer.
- 26. VENT ON/OFF:** Touch this pad to turn the fan on/off.
- 27. VENT 5-SPEED:** Touch this pad to choose one of 5 fan speeds.
- 28. VENT AUTO TIMESET:** Touch this pad when setting ventilation time. (1, 3, 5, 10, and 30 minutes.)

MICROWAVE COOKING TIPS

Amount of food

- **If you increase or decrease** the amount of food you prepare, the time it takes to cook that food will also change. For example, if you double a recipe, add a little more than half the original cooking time. Check for doneness and, if necessary, add more time in small increments.

Starting temperature of food

- **The lower the temperature** of the food being put into the microwave oven, the longer it takes to cook. Food at room temperature will be re-heated more quickly than food at refrigerator temperature.

Composition of food

- **Food with a lot of fat and sugar** will be heated faster than food containing a lot of water. Fat and sugar will also reach a higher temperature than water in the cooking process.
- **The more dense the food**, the longer it takes to heat. Very dense food like meat takes longer to heat than lighter, more porous food like sponge cakes.

Size and shape

- **Smaller pieces of food** will cook faster than larger pieces. Also, same-shaped pieces cook more evenly than different-shaped pieces.
- **With foods that have different thicknesses**, the thinner parts will cook faster than the thicker parts. Place the thinner parts of chicken wings and legs in the center of the dish.

Stirring, turning foods

- **Stirring and turning foods** spreads heat quickly to the center of the dish and avoids overcooking at the outer edges of the food.

Covering food

Cover food to:

- **Reduce** splattering
- **Shorten** cooking times
- **Keep** food moist

Releasing pressure in foods

- **Several foods** (for example: baked potatoes, sausages, egg yolks, and some fruits) are tightly covered by a skin or membrane. Steam can build up under the membrane during cooking, causing the food to burst. To relieve the pressure and to prevent bursting, pierce these foods before cooking with a fork, cocktail pick, or toothpick.

Using standing time

- **Always allow food to stand** either in or out of the oven after cooking power stops. Standing time after defrosting and cooking allows the temperature to evenly spread throughout the food, improving the cooking results. For inside oven standing time, you can program a **0** power second stage of the cooking cycle. See cooking with more than on cook cycle cooking.
- **The length of the standing time** depends on how much food you are cooking and how dense it is. Sometimes it can be as short as the time it takes you to remove the food from the oven and take it to the serving table. However, with larger, denser food item, the standing time may be as long as 10 minutes.

Arranging food

For best results, place food evenly on the plate. You can do this in several ways:

- **If you are cooking several items of the same food**, such as baked potatoes, **place** them in a ring pattern for uniform cooking.
- **When cooking foods of uneven shapes or thickness, such as chicken breasts, place** the smaller or thinner area of the food towards the center of the dish where it will be heated last.
- **Layer thin slices of meat** on top of each other.
- **When you cook or reheat whole fish, score** the skin – this prevents cracking.
- **Do not** let food or a container touch the top or sides of the oven. This will prevent possible arcing.

MICROWAVE COOKING TIPS

Using aluminum foil

Metal containers should not be used in a microwave oven. There are, however, some exceptions. If you have purchased food which is prepackaged in an aluminum foil container, refer to the instructions on the package. When using aluminum foil containers, cooking times may be longer because microwaves will only penetrate the exposed top of the food and not the bottom or the sides. If you use aluminum containers without package instructions, follow these guidelines:

- **Place** the aluminum foil container in a glass bowl and add some Water so that it covers the bottom of the container, but not more than 1/4 in. (.64 cm) deep. This ensures even heating of the container bottom.
- **Always remove** the container lid to avoid damage to the oven.
- **Use only** undamaged containers.
- **Do not use** containers taller than 3/4 in. (1.9 cm).
- **Container must be** at least half filled.
- **To avoid arcing**, there must be a minimum 1/4 in. (64 mm) between the aluminum container and the walls of the oven and also between two aluminum containers.
- **Always place** the container on the turntable.
- **Shield** parts of food that may cook quickly, such as wing tips and leg ends of poultry, with small pieces of aluminum foil.
- **Heating food** in aluminum foil containers usually takes up to double the time compared to reheating in plastic, glass, china, or paper containers. The time when food is ready will vary depending upon the type of container you use.
- **Let food stand** for 2 to 3 minutes after heating so that heat is spread evenly throughout the container.

Cooking you should not do in your microwave oven

- **Do not** do canning of foods in the oven. Closed glass jars may explode, resulting in damage to the oven.
- **Do not** use the microwave oven to sterilize objects (baby bottles, etc.). It is difficult to keep the oven at the high temperature needed for sterilization.

Removing the rack

- When popping commercially packaged popcorn, **remove the rack and drip pan from the oven**; Do not place the bag of microwave popcorn on the rack or under the rack. Leave the glass tray in place at all times.

CAUTION : Popping microwave popcorn with rack and drip pan can cause fire or damage to your microwave oven.

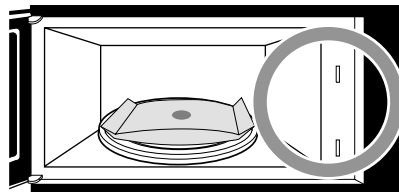
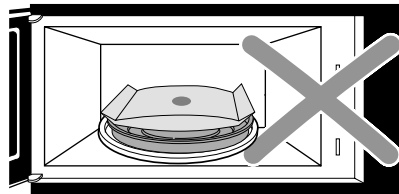
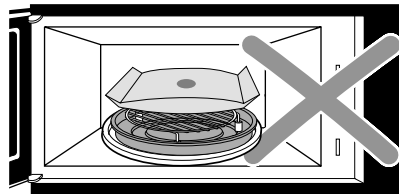

MICROWAVE COOKING TIPS

Cooking Comparison Guide

Cooking with your new oven offers a wide variety of food preparation options: microwave cooking, convection cooking, and combination cooking.

Microwave cooking uses very short, high-frequency radio waves. The movement of the microwaves through the food generates heat and cooks most foods faster than regular methods, while retaining their natural texture and moisture. Microwave cooking heats food directly, not the cookware or the interior of the oven. Reheating is easy and defrosting is particularly convenient because less time is spent in food preparation.

Convection cooking constantly circulates heated air around the food, creating even browning and sealed-in flavor by the constant motion of hot air over the food surfaces.

Combination cooking combines microwave energy with convection to cook with speed and accuracy, while browning and crisping to perfection.

You can use microwave cooking, convection cooking, or combination cooking to cook by time. Simply preset the length of cooking time desired and your oven turns off automatically.

The following guide shows at a glance the difference between microwave, convection, and combination cooking.

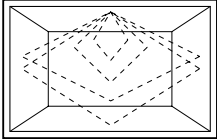
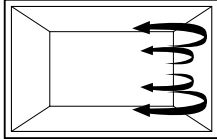
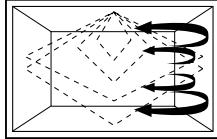
	MICROWAVE	CONVECTION	COMBINATION
COOKING METHOD	 <p>Microwave energy is distributed evenly throughout the oven for fast, thorough cooking of food.</p>	 <p>Hot air circulates around food to produce browned exteriors and sealed-in juices.</p>	 <p>Microwave energy and convection heat combine to shorten the cooking time of regular ovens, while browning and sealing in juices.</p>
HEAT SOURCE	Microwave energy.	Circulating heated air.	Microwave energy and circulating heated air.
BENEFITS	<ul style="list-style-type: none"> • Fast, high efficiency cooking. • Oven and surroundings do not get hot. • Easy clean-up. 	<ul style="list-style-type: none"> • Aids in browning and seals in flavor. • Cooks some foods faster than regular ovens. 	<ul style="list-style-type: none"> • Shortened cooking time from microwave energy. • Browning and crisping from convection heat.
<p>Read this guide to learn the many different things your Microwave/Convection/Combination Oven can do. You will find a wide variety of cooking methods and programs designed to suit your lifestyle.</p>			

MICROWAVE COOKING TIPS

COOKWARE GUIDE

Microwave Cooking

Most heat-resistant, non-metallic cookware is safe for use in your microwave oven.

To test cookware before using, follow these steps:

1. Place the empty cookware in the microwave oven.
2. Measure 1 cup of water in a glass measuring cup and place it in the oven beside the cookware.
3. Microwave on 100% power for 1 minute. If the dish is warm, it **should not** be used for microwave cooking.

Convection Cooking

- Metal Pans are recommended for all types of baked products, but especially where browning or crusting is important.
- Dark or dull finish metal pans are best for breads and pies because they absorb heat and produce a crisper crust.
- Shiny aluminum pans are better for cakes, cookies, or muffins because these pans reflect heat and help produce a light, tender crust.
- Glass or glass-ceramic casserole or baking dishes are best suited for egg and cheese recipes due to the cleanability of glass.

Combination Cooking

- Glass or glass-ceramic baking containers are recommended. Be sure not to use items with metal trim as it may cause arcing (sparking) with oven wall or oven shelf, damaging the cookware, the shelf, or the oven.
- Heat-resistant plastic microwave cookware (safe to 450°F) may be used, but is not recommended for foods that require crusting or all-around browning, because plastic is a poor conductor of heat.

COOKWARE	MICROWAVE	CONVECTION	COMBINATION
Heat-Resistant Glass, Ceramic Glass	Yes	Yes	Yes
Ceramics, China	Yes (Do not use china with gold or silver trim.)	Yes	Yes
Metal Cookware	No	Yes	No
Non Heat-Resistant Glass	No	No	No
Microwave-Safe Plastic	Yes	No	Yes*
Plastic Wrap, Wax Paper	Yes	No	No
Paper Products	Yes	No	No
Straw, Wicker, and Wood	Yes	No	No

* Use only microwave cookware that is safe to 450°F

MICROWAVE COOKING TIPS

HOW TO USE ACCESSORIES



Glass Turntable

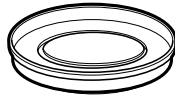

Metal Tray

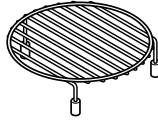

Metal Rack

- : Possible to use
 ⊙ : Recommended method
 X : Do not use

	MICROWAVE	CONVECTION	COMBINATION
	⊙	○	○
	X	○	○
	X	⊙	⊙
	X	⊙	X
	X	⊙	⊙

Notes :

- Do not operate the oven when it is empty except preheating in the convection mode only. NEVER operate the microwave while the oven is empty.

OPERATION

LEARN ABOUT YOUR MICROWAVE OVEN

This section discusses the concepts behind microwave cooking and introduces you to the basics you need to know to operate your microwave oven. Please read this information before using your oven.

CAUTION

To avoid risk of personal injury or property damage, do not use stoneware, metal utensils, or metal trimmed utensils in the oven.

CAUTION

To avoid risk of personal injury or property damage, do not run oven empty.

AUDIBLE SIGNALS

Audible signals are available to guide you when setting and using your oven:

- A tone will sound each time you touch a pad.
- Seven tones signal the end of a Timer countdown.
- Four tones signal the end of a cooking cycle.

CLOCK

When your microwave oven is first plugged in or after a power failure, the Display will show "PLEASE SET TIME OF DAY". If a time of day is not set, ":" (a colon) will show on the Display until you touch "CLOCK".

Example: To set the clock for 10:30(AM).



1. Touch **STOP/CLEAR**.

CLOCK

2. Touch **CLOCK**.

1 0 3 0
100°F 450°F 275°F 450°F

3. Enter the time by using the number key pad.



4. Touch **START/ENTER**.

1
100°F

5. Touch **1**.
(Press 1 for AM,
Press 2 for PM)



6. Touch **START/ENTER**.

INTERRUPTING COOKING

You can stop the oven during a cycle by opening the door. The oven stops heating and the fan stops, but the light stays on. **To restart cooking**, close the door and Touch **START/ENTER**.

If you do not want to continue cooking, open the door and touch STOP/CLEAR.

CHILD LOCK

Use this safety feature to lock the control panel when you are cleaning the oven, or so children cannot use the oven unsupervised.

Example: To set the child lock.



1. Touch **STOP/CLEAR**.

2. Touch and hold **START/ENTER** until "LOCKED" appears in the display (approximately 4 seconds) and you hear two beeps.



Example: To cancel the child lock.



1. Touch and hold **START/ENTER** until "LOCKED" disappears (approximately 4 seconds) and you hear two beeps.

NOTES:

- If you enter in an incorrect time and touch "CLOCK", you cannot set time of day. Enter the correct time.
- If you touch STOP/CLEAR while setting the clock, the Display will show the last time of day set or ":" (a colon) if no time of day has been set.

OPERATION

TIMER

Your microwave oven can be used as a timer. You can set up to 99 minutes and 99 seconds.

Example: To set 3 minutes.

TIMER	1. Touch TIMER .
	2. Enter the time by using the number key pad.
	3. Touch START/ENTER . When the time is over, you will hear seven beeps and END will display.

CUSTOM COOK

CUSTOM COOK lets you to recall one cooking instruction previously placed in memory and begin cooking quickly.

Example: To memorize for 2 minutes.

	1. Touch STOP/CLEAR .
CUSTOM COOK	2. Touch CUSTOM COOK .
MICRO.	3. Touch MICRO .
	4. Enter the cook time.
	5. Touch START/ENTER .

Example: To recall the memory.

	1. Touch STOP/CLEAR .
CUSTOM COOK	2. Touch CUSTOM COOK .
	3. Touch START/ENTER . When the cook time is over, you will hear four beeps and COOK END will display.

VENT FAN

The bottom of the control panel controls the 5-speed vent fan.

Example: To set Level 4.

ON/OFF	1. Touch VENT ON/OFF . This shows the last level until you select the fan speed level.
5-SPEED	2. Touch VENT 5-SPEED until LEVEL 4 appears in the display.
	Turn off fan when desired.

NOTES:

- If the temperature from the range or cooktop below the oven gets too hot, the vent fan in the vent hood will automatically turn on at the 4-Speed setting to protect the oven. It may stay on up to an hour to cool the oven. When this occurs, the VENT ON/OFF pad will not turn the fan off. You cannot turn the vent fan off during microwave cooking.

VENT FAN AUTO TIME SET

Example: To turn off fan after 30 minutes for level 4.

ON/OFF	1. Touch ON/OFF .
5-SPEED	2. Touch this pad until Level 4 appears in the display.
AUTO TIMESET	3. Touch this pad five times.
	1 time - 1 minutes 2 times - 3 minutes 3 times - 5 minutes 4 times - 10 minutes 5 times - 30 minutes

EZ-ON

A time-saving pad, this simplified control lets you quickly set and start microwave cooking at 100% power without the need to touch **START/ENTER**.

Example: To cook for 1 minutes.

EZ-ON	1. Touch EZ-ON 2 times. The oven begins cooking and display shows time counting down.
--------------	--

NOTES:

- Each time you touch **EZ-ON**, it will add 30 seconds, up to 99 minutes and 59 seconds.

OPERATION

TURNTABLE ON/OFF

TURNTABLE ON/OFF

For best cooking results, leave the turntable on. It can be turned off for large dishes. Touch **TURNTABLE ON/OFF** to turn the turntable on or off.

NOTES:

- This option is not available in sensor cook and defrost modes.
- **Sometimes the turntable can become hot to touch.** Be careful touching the turntable during and after cooking.
- **Do not run the oven empty.**

LIGHT ON/OFF

LIGHT ON/OFF

To turn the Hood Light on, touch **LIGHT ON/OFF** once.
To turn the Hood Light off, touch **LIGHT ON/OFF** again.

MORE/LESS

— LESS + MORE

By using the **MORE** or **LESS** keys, all of the preprogrammed cook and time cook features can be adjusted to cook food for a

longer or shorter time.

Pressing **MORE** will add 10 seconds of cooking time each time you press it. Pressing **LESS** will subtract 10 seconds of cooking time each time you press it.

CUSTOM SET

You can change the default values for clock set, beep sound, display speed, and defrost weight. See following chart for more information.

NUMBER	FUNCTION	NUMBER	RESULT
1	Beep ON/ OFF control	1	Sound ON
		2	Sound OFF
2	Clock display control	1	Clock ON
		2	Clock OFF
3	Display	1	Slow speed
		2	Normal speed
		3	Fast speed
4	Defrost weight mode selected	1	Lbs.
		2	Kg.

Example: To change defrost weight mode.(from Lbs. to Kg.)

CUSTOM SET

1. Touch **CUSTOM SET.**

4
300°F

2. Touch number **4.**

2
250°F

3. Touch number **2.**

COOKING AT HIGH POWER LEVEL

Example: To cook food for 8 minutes 30 seconds.

8 3 0
400°F 275°F 450°F

1. Enter the cook time.



2. Touch **START/ENTER.**

When the cook time is over, you will hear four beeps and **COOK END** will display.

OPERATION

COOKING AT LOWER POWER LEVELS

HIGH power cooking does not always give you the best results with foods that need slower cooking, such as roasts, baked goods, or custards. Your oven has 10 power settings in addition to HIGH.

Example: To cook food for 7 minutes 30 seconds at 70% power.

MICRO.

1. Touch **MICRO.**

7 3 0
375°F 275°F 450°F

2. Enter the cook time.

**POWER
LEVEL**

3. Touch **POWER LEVEL.**

7
375°F

4. Enter the power level.

**START
ENTER** 

5. Touch **START/ENTER.**
When the cook time is over,
you will hear four beeps and
COOK END will display.

COOKING WITH MORE THAN ONE COOK CYCLE

For best results, some recipes call for one Power Level for a certain length of time, and another Power Level for another length of time. Your oven can be set to change from one to another automatically, for up to three cycles if the first heating cycle is defrost or the last at 0% power.

Example: To cook food for 3 minutes at 100% power and then 70% power for 7 minutes 30 seconds.

MICRO.

1. Touch **MICRO.**

3 0 0
275°F 450°F 450°F

2. Enter the first cook time.

MICRO.

3. Touch **MICRO.**

7 3 0
375°F 275°F 450°F

4. Enter the second cook time.

**POWER
LEVEL**

5. Touch **POWER LEVEL.**

7
375°F

6. Enter the power level.

**START
ENTER** 

7. Touch **START/ENTER.**
When the cook time is over,
you will hear four beeps
and **COOK END** will display.

When the first stage is over, you will hear two short tones as the oven begins the second cook stage.

OPERATION

COOKING GUIDE FOR LOWER POWER LEVELS

The nine power levels in addition to HIGH allow you to choose the best power level for the food you are cooking. Below are listed all the power levels,



examples of foods best cooked at each level, and the amount of microwave power you are using.

POWER LEVEL	MICROWAVE OUTPUT	USE
10 HIGH	100%	<ul style="list-style-type: none"> • Quick heating many convenience foods and foods with high water content, such as soups and beverages. • Cooking tender cuts of meat, ground meat
9	90%	<ul style="list-style-type: none"> • Heating cream soups
8	80%	<ul style="list-style-type: none"> • Heating rice, pasta, or casseroles
7	70%	<ul style="list-style-type: none"> • Cooking and heating foods that need a Cook Power lower than high (for example, whole fish and meat loaf) or when food is cooking too fast • Reheating a single serving of food
6	60%	<ul style="list-style-type: none"> • Cooking requiring special care, such as cheese and egg dishes, pudding, and custards • Finishing cooking casseroles
5	50%	<ul style="list-style-type: none"> • Cooking ham, whole poultry, and pot roasts • Simmering stews
4	40%	<ul style="list-style-type: none"> • Melting chocolate • Heating pastries
3	30%	<ul style="list-style-type: none"> • Manually defrosting foods, such as bread, fish, meats, poultry, and precooked foods
2	20%	<ul style="list-style-type: none"> • Softening butter, cheese, and ice cream
1	10%	<ul style="list-style-type: none"> • Keeping food warm • Taking chill out of fruit
0	0%	<ul style="list-style-type: none"> • Standing time in oven

OPERATION



SOFTEN

The oven uses low power to soften foods (butter, ice cream, cream cheese, and frozen juice). See the following table.

Example for quart of ice cream.	
SOFTEN	1. Touch SOFTEN .
	2. Choose the category. Touch 2 for ice cream.
	3. Touch 2 .
	4. Touch START/ENTER .
	When the cook time is over, you will hear four beeps and COOK END will be displayed.

MELT

The oven uses low power to melt foods (butter or margarine, chocolate, processed cheese food, or marshmallows). See the following table.

Example for 8 oz. Chocolate.	
MELT	1. Touch MELT .
	2. Choose the category. Touch 2 for chocolate.
	3. Touch 2 .
	4. Touch START/ENTER .
	When the cook time is over, you will hear four beeps and COOK END will be displayed.

SOFTEN TABLE

CODE	CATEGORY	DIRECTION	AMOUNT
1	Butter	Unwrap and place in microwavable container. Butter will be at room temperature and ready for use in recipe.	1, 2 or 3 sticks
2	Ice cream	Place container in oven. Ice cream will be soft enough to make scooping easier.	Pint, Quart, Half gallon
3	Cream cheese	Unwrap and place in microwavable Container. Cream cheese will be at room temperature and ready for use in recipe.	3 or 8 oz.
4	Frozen juice	Remove top. Place in oven. Frozen juice will be soft enough to mix easily with water.	6, 12 or 16 oz.

MELT TABLE

CODE	CATEGORY	DIRECTION	AMOUNT
1	Butter or Margarine	Unwrap and place in microwavable container. No need to cover butter. Stir at the end of cooking to complete melting.	1, 2 or 3 sticks
2	Chocolate	Chocolate chips or squares of baking chocolate may be used. Unwrap squares and place in microwavable container. Stir at the end of cycle to complete melting.	4 or 8 oz.
3	Cheese	Use processed cheese food only. Cut into cubes. Place in a single layer in microwavable container. Stir at the end of cooking to complete melting.	8 or 16 oz.
4	Marshmallows	Large or miniature marshmallows may be used. Place in microwavable container. Stir at the end of cycle to complete melting.	5 or 10 oz.

OPERATION

AUTO DEFROST

Five defrost sequences are preset in the oven. The auto defrost feature provides you with the best defrosting method for frozen foods. The Auto Defrost Table will show you which defrost sequence is recommended for the food you are defrosting. For added convenience, the Auto Defrost includes a built-in beep mechanism that reminds you to check, turn over, separate, or rearrange to get best defrost results. Five different defrost settings are provided.

- 1 MEAT
- 2 POULTRY
- 3 FISH
- 4 BREAD
- 5 RAPID - only 1 lb.

Example: To defrost 1.2 lbs. of meat.

AUTO DEFROST

1. Touch **AUTO DEFROST**.

1
100°F

2. Choose food category.

Category	Touch pad number
Meat	1
Poultry	2
Fish	3
Bread	4
RAPID	5

1 2
100°F 250°F

3. Enter the weight.

START
ENTER 

4. Touch **START/ENTER**.

NOTE: When you touch the START/ENTER pad, the display changes to defrost time count down. The oven will beep during the DEFROST cycle. At this time, open the door and turn, separate, or rearrange the food. Remove any portions that have thawed. Return frozen portions to the oven and touch START/ENTER to resume the defrost cycle.

WEIGHT CONVERSION TABLE

You are probably used to food weights as being in pounds and ounces that are fractions of a pound (for example, 4 ounces equals 1/4 pound). However, in order to enter food weight in Auto Defrost, you must specify pounds and tenths of a pound. If the weight on the food package is in fractions of a pound, you can use the following table to convert the weight to decimals.

Equivalent Weight		
OUNCES	DECIMAL WEIGHT	
1.6	.10	
3.2	.20	
4.8	.30	
6.4	.40	
8.0	.50	One-Half Pound
9.6	.60	
11.2	.70	
12.8	.80	
14.4	.90	
16.0	1.00	One Pound

OPERATING TIPS

- For best results, remove fish, shellfish, meat, and poultry from its original closed paper or plastic package (wrapper). Otherwise, the wrap will hold steam and juice close to the foods, which can cause the outer surface of the foods to cook.
- For best results, shape your ground meat into the form of a doughnut before freezing. When defrosting, scrape off thawed meat when the beep sounds and continue defrosting.
- Place foods in a shallow container or on a microwave roasting rack to catch drippings.
- For more defrost help, please read **Defrosting Tips** following the Auto Defrost Table.

This table shows you food type selections and the weights you can set for each type. For best results, loosen or remove covering on food.

FOOD	TOUCH Auto Defrost	WEIGHTS YOU CAN SET (tenths of a pound)
Meat	1	0.1 to 6.0 (0.045kg to 2.722kg)
Poultry	2	0.1 to 6.0 (0.045kg to 2.722kg)
Fish	3	0.1 to 6.0 (0.045kg to 2.722kg)
Bread	4	0.1 to 1.0 (0.045kg to 0.454kg)
Rapid	5	only 1 lb.

OPERATION

AUTO DEFROST TABLE

Meat setting

FOOD	SETTING	AT BEEP	SPECIAL INSTRUCTIONS
BEEF			Meat of irregular shape and large, fatty cuts of meat should have the narrow or fatty areas shielded with foil at the beginning of a defrost sequence.
Ground Beef, Bulk	MEAT	Remove thawed portions with fork. Turn over. Return remainder to oven.	Do not defrost less than 1/4 lb. Freeze in doughnut shape.
Ground Beef, Patties	MEAT	Separate and rearrange.	Do not defrost less than 2 oz. patties. Depress center when freezing.
Round Steak	MEAT	Turn over. Cover warm areas with aluminum foil.	Place on a microwavable roasting rack.
Tenderloin Steak	MEAT	Turn over. Cover warm areas with aluminum foil.	Place on a microwavable roasting rack.
Stew Beef	MEAT	Remove thawed portions with fork. Separate remainder. Return remainder to oven.	Place in a microwavable baking dish.
Pot Roast, Chuck Roast	MEAT	Turn over. Cover warm areas with aluminum foil.	Place on a microwavable roasting rack.
Rib Roast	MEAT	Turn over. Cover warm areas with aluminum foil.	Place on a microwavable roasting rack.
Rolled Rump Roast	MEAT	Turn over. Cover warm areas with aluminum foil.	Place on a microwavable roasting rack.
LAMB			
Cubes for Stew	MEAT	Remove thawed portions with fork. Return remainder to oven.	Place in a microwavable baking dish.
Chops (1 inch thick)	MEAT	Separate and rearrange.	Place on a microwavable roasting rack.
PORK			
Chops (1/2 inch thick)	MEAT	Separate and rearrange.	Place on a microwavable roasting rack.
Hot Dogs	MEAT	Separate and rearrange.	Place on a microwavable roasting rack.
Spareribs Country-style Ribs	MEAT	Turn over. Cover warm areas with aluminum foil.	Place on a microwavable roasting rack.
Sausage, Links	MEAT	Separate and rearrange.	Place on a microwavable roasting rack.
Sausage, Bulk	MEAT	Remove thawed portions with fork. Turn over. Return remainder to oven.	Place in a microwavable baking dish.
Loin Roast, Boneless	MEAT	Turn over. Cover warm areas with aluminum foil.	Place on a microwavable roasting rack.

OPERATION

AUTO DEFROST TABLE (CONT.)

Poultry setting

FOOD	SETTING	AT BEEP	SPECIAL INSTRUCTIONS
CHICKEN Whole (up to 6 lbs) Cut-up	POULTRY	Turn over (finish defrosting breast-side down). Cover warm areas with aluminum foil. Separate pieces and rearrange. Turn over. Cover warm areas with aluminum foil.	Place chicken breast-side up on a microwavable roasting rack. Finish defrosting by immersing in cold water. Remove giblets when chicken is partially defrosted. Place on a microwavable roasting rack. Finish defrosting by immersing in cold water.
CORNISH HENS Whole	POULTRY	Turn over. Cover warm areas with aluminum foil.	Place on a microwavable roasting rack. Finish defrosting by immersing in cold water.
TURKEY Breast (up to 6 lbs)	POULTRY	Turn over. Cover warm areas with aluminum foil.	Place on a microwavable roasting rack. Finish defrosting by immersing in cold water.

Fish setting

FOOD	SETTING	AT BEEP	SPECIAL INSTRUCTIONS
FISH Fillets	FISH	Turn over. Separate fillets when partially thawed if possible.	Place in a microwavable baking dish. Carefully separate fillets under cold water.
Steaks	FISH	Separate and rearrange.	Place in a microwavable baking dish. Run cold water over to finish defrosting.
Whole	FISH	Turn over.	Place in a microwavable baking dish. Cover head and tail with foil; do not let foil touch sides of microwave. Finish defrosting by immersing in cold water.
SHELLFISH Crabmeat	FISH	Break apart. Turn over.	Place in a microwavable baking dish.
Lobster tails	FISH	Turn over and rearrange.	Place in a microwavable baking dish.
Shrimp	FISH	Separate and rearrange.	Place in a microwavable baking dish.
Scallops	FISH	Separate and rearrange.	Place in a microwavable baking dish.

OPERATION

AUTO DEFROST TABLE (CONT.)

Bread setting

FOOD	SETTING	AT BEEP	SPECIAL INSTRUCTIONS
Bagel Dinner Roll Muffin Hamburger Hot Dog Bun Slices of Bread Loaf of Bread	BREAD	Turn over and rearrange.	Place on 3 sheets of paper towel. NOTE: Do not use recycled paper products in the microwave oven. They sometimes contain impurities that cause arcing and sparking. NEVER use paper products in the convection oven.

DEFROSTING TIPS

- **When using** Auto Defrost, the weight to be entered is the net weight in pounds and tenths of pounds (the weight of the food minus the container).
- **Before starting**, make sure you have removed any of the metal twist-ties which often come with frozen food bags, and replace them with strings or elastic bands.
- **Open containers** such as cartons before they are placed in the oven.
- **Always slit** or pierce plastic pouches or packaging.
- **If food is foil wrapped**, remove foil and place the food in a suitable container.
- **Slit** the skins, if any, of frozen food such as sausage.
- **Bend** plastic pouches of food to ensure even defrosting.
- **Always underestimate** defrosting time. If defrosted food is still icy in the center, return it to the microwave oven for more defrosting.
- **The length** of defrosting time varies according to how solidly the food is frozen.
- **The shape of the package** affects how quickly food will defrost. Shallow packages will defrost more quickly than a deep block.
- **As food begins to defrost**, separate the pieces. Separated pieces defrost more easily.
- **Use small pieces of aluminum foil** to shield parts of food such as chicken wings, leg tips, fish tails, or areas that start to get warm. Make sure the foil does not touch the sides, top, or bottom of the oven. The foil can damage the oven lining.
- **For better results**, let food stand after defrosting. (For more information on standing time, see the **Microwave Cooking Tips** section.)
- **Turn over** food during defrosting or standing time. Break apart and remove food as required.

OPERATION

SENSOR OPERATING INSTRUCTIONS

Sensor Cook allows you to cook most of your favorite foods without selecting cooking times and power levels. The oven automatically determines required cooking time for each food item. When the internal sensor detects a certain amount of humidity coming from the food, it will tell the oven how much longer to heat. The display will show the remaining heating time. For best results for cooking by Sensor, follow these recommendations.

1. Food cooked with the sensor system should be at normal storage temperature.
2. The Glass Tray and the outside of the container should be dry to assure best cooking results.
3. Foods should always be covered loosely with microwavable plastic wrap, waxed paper, or a lid.
4. Do not open the door or touch **STOP/CLEAR** during the sensing time. When sensing time is over, the oven beeps and the remaining cooking time will appear in the display window. At this time you can open the door to stir, turn, or rearrange the food.

SENSOR COOKING GUIDE

Appropriate containers and coverings help assure good Sensor cooking results.

1. Always use microwavable containers and cover them with lids or vented plastic wrap.
2. Never use tight-sealing plastic covers. They can prevent steam from escaping and cause food to overcook.
3. Match the amount to the size of the container. Fill containers at least half full for best results.
4. Be sure the outside of the cooking container and the inside of the microwave oven are dry before placing food in the oven. Beads of moisture turning into steam can mislead the sensor.

SENSOR COOK

Using SENSOR COOK lets you heat common microwave-prepared foods without needing to program times and Cook Powers. SENSOR COOK has preset Cook Power for 6 food categories.

Example: To cook rice.	
COOK	1. Touch COOK .
6 <small>350°F</small>	2. Touch 6 .
	When the cook time is over, you will hear four beeps and COOK END will display.

SENSOR REHEAT

Using SENSOR REHEAT lets you reheat common microwave-prepared foods without selecting cooking times and power levels.

Example: To reheat 2 slices of pizza.	
REHEAT	1. Touch REHEAT .
4 <small>300°F</small>	2. Touch 4 .
	When the cook time is over, you will hear four beeps and COOK END will display.

SENSOR POPCORN

POPCORN lets you pop commercially packaged microwave popcorn. Pop only one package at a time. For best results, use fresh bags of popcorn.

Example: To pop popcorn.	
POPCORN	1. Touch POPCORN .
	When the cook time is over, you will hear four beeps and COOK END will display.

OPERATION

SENSOR COOK TABLE

TOUCH PAD NUMBER	CATEGORY	DIRECTION	AMOUNT
1	Baked Potato	Pierce each potato with a fork and place on the oven tray around the edge, at least one inch apart. After cooking, allow to stand for 5 minutes.	1~4 medium (approx. 8 to 10 oz. each)
2	Frozen Vegetable	Remove from package, rinse off frost under running water. Place in an appropriately sized microwave container. Add amount of water according to the quantity (1~2 cups : 2 tablespoons, 3~4 cups : 4 tablespoons). Cover with plastic wrap and vent. After cooking, stir and allow to stand for 3 minutes.	1~4 cups
3	Fresh Vegetable	Prepare as desired, wash, and leave residual water on the vegetables. Place in an appropriately sized microwave container. Add amount of water according to the quantity (1~2 cups : 2 tablespoons, 3~4 cups : 4 tablespoons). Cover with plastic wrap and vent. After cooking, stir and allow to stand for 3 minutes.	1~4 cups
4	Canned Vegetable	Remove from the can. Place in an appropriately sized microwave container, cover with plastic wrap, and vent. After cooking, stir and allow to stand for 3 minutes.	1~4 cups
5	Frozen Entree	Remove from outer display package. Slit cover. If not in microwave-safe container, place on a plate. Cover with plastic wrap and vent the plastic film by piercing with a fork (3 times). After cooking, allow to stand for 3 minutes.	10 to 21 oz.
6	Rice	Place rice and twice as much liquid (water, chicken or vegetable stock) in a 2-quart microwave dish. Cover with plastic wrap and vent. After cooking, allow to stand for 10 minutes. Stir for fluffier rice.	1/2-2 cups Use medium or long grain rice. Cook instant rice according to directions on the package.

SENSOR REHEAT TABLE

TOUCH PAD NUMBER	CATEGORY	DIRECTION	AMOUNT
1	Dinner Plate	Place on a low plate. Cover with vented plastic wrap. Let stand 3 minutes after cooking.	1 to 2 servings
2	Soup/Sauce	Place in shallow microwavable casserole. Cover with vented plastic wrap. After cooking, stir and let stand 3 minutes.	1~4 cups
3	Casserole	Place in a microwavable bowl or casserole. Cover with vented plastic wrap. After cooking, stir and let stand 3 minutes.	1~4 cups
4	Pizza Slice	This function is for re-heating pizza that was cooked previously. It is NOT for raw, ready-to-bake, or frozen pizza. Place the pizza slice(s) on a paper towel or microwave safe plate.	1~4 slices

OPERATION

AUTO COOK

Auto Cook lets you heat common microwave-prepared foods without selecting cooking times and power levels. Auto Cook has preset cook powers for 6 food functions.

Example: To cook bacon 2 slices.	
AUTO COOK	1. Touch AUTO COOK .
1 100°F	2. Choose food category.
2 250°F	3. Touch 2 .
	4. Touch START/ENTER .

AUTO COOK TABLE

TOUCH PAD NUMBER	CATEGORY	DIRECTION	AMOUNT
1	Bacon	Place bacon strips on a microwave bacon rack for best results. (Use dinner plate lined with paper towels if rack is not available).	2~6 slices
2	Fresh Roll/Muffin	Remove from display package and place on plate. (If muffins are over 3 oz. each, count as two when entering quantity).	1~6 pieces (2-3 oz. each)
3	Frozen Roll/Muffin	Remove from display package and place on plate. (If muffins are over 3 oz. each, count as two when entering quantity).	1~6 pieces (2-3 oz. each)
4	Beverage	Use a wide-mouth mug. Do not cover. (Be careful! The beverage will be very hot! Sometimes liquids heated in cylindrical containers will splash out when the cup is moved).	1~2 cups
5	Chicken Pieces	Place the chicken pieces in an appropriately sized microwavable container, cover with plastic wrap, and vent.	0.5 ~ 2 lbs.
6	Hot cereal	Prepare as directed on package and cook. Stir well before eating. Use only instant hot cereal.	1~6 servings

NOTE:

Do not use recycled paper products in the microwave oven. They sometimes contain impurities that cause arcing and sparking.

NEVER use paper products in the convection oven.

OPERATION

TIPS FOR CONVECTION COOKING

This section gives you cooking instructions and procedures for operating each convection function.

Please read these instructions carefully.

Convection cooking circulates hot air through the oven cavity with a fan. The constantly moving air surrounds the food to heat the outer portion quickly, creating even browning and sealed-in flavor by the constant motion of hot air over the food surfaces. Your oven uses convection cooking whenever you use the Convection Button. **DO NOT USE THE OVEN WITHOUT THE TURNTABLE IN PLACE.**

1. **Always use the metal rack** on the turntable when convection cooking.
2. **Do not cover** turntable or metal rack with aluminum foil. It interferes with the flow of air that cooks the food.
3. **Round pizza pans** are excellent cooking utensils for many convection-only items. Choose pans that do not have extended handles.
4. **Use convection cooking** for items like soufflés, breads, cookies, angel food cakes, pizza, and for some meat and fish cooking.
5. **Your oven comes** equipped with metal tray which can be used for cooking in convection mode or combination mode.
6. **You do not need to use** any special techniques to adapt your favorite oven recipes to convection cooking; however, you need to lower oven temperature by 25°F from recommended temperature mentioned in package instructions when cooking packaged food in convection mode.
7. **When baking** cakes, cookies, breads, rolls, or other baked foods, most recipes call for preheating. Preheat the empty oven just as you do a regular oven. You can start heavier dense foods such as meats, casseroles, and poultry without preheating.
8. **All heatproof** cookware or metal utensils can be used in convection cooking.
9. **As in conventional cooking**, the distance of the food from the heat source affects cooking results. Refer to the charts in this Use and Care Guide.

10. **Use metal utensils** only for convection cooking. Never use for microwave or combination cooking since arcing and damage to the oven may occur.

11. **After preheating**, if you do not open the door, the oven will automatically hold at the preheated temperature for 30 minutes.

PRECAUTIONS

• The oven cavity, door, turntable, roller rest, metal tray, metal rack, and cooking utensils will become very hot.

USE THICK OVEN GLOVES when removing the food, cooking utensils, metal rack, metal tray, and turntable from the oven after convection cooking.

• Do not use lightweight plastic containers, plastic wraps, or paper products during any convection cycle.

OPERATION

CONVECTION

During convection cooking, a heating element is used to raise the temperature of the air inside the oven. Convection cooking temperature ranges from 100°F to 450°F.

It is best to preheat the oven when convection cooking.

Note: Lower oven temperature by 25°F from package recommended temperature instructions. The baking time may vary according to the food condition or individual preference.

Example: To set the convection cooking at 325°F for 45 minutes with preheating.

STOP
CLEAR

1. Touch **STOP/CLEAR**.

CONV.

2. Touch **CONV.**

5
325°F

3. Touch **5**.

START
ENTER

2X 4. Touch **START/ENTER** twice.

4 5 0 0
300°F 325°F 450°F 450°F

5. Touch **4, 5, 0, and 0**.

START
ENTER

6. Touch **START/ENTER**.

Example: To set the convection cooking at 375°F for 30 minutes without preheating.

STOP
CLEAR

1. Touch **STOP/CLEAR**.

CONV.

2. Touch **CONV.**

7
375°F

3. Touch **7**.

START
ENTER

4. Touch **START/ENTER**.

NOTE: If you press **START/ENTER**, the oven will start.

3 0 0 0
275°F 450°F 450°F 450°F

5. Touch **3, 0, 0, and 0**.

START
ENTER

6. Touch **START/ENTER**.

NOTE: The temperature range has 10 steps from 100°F to 450°F.

NOTES:

- When the oven reaches the set preheat temperature, five (5) tones will sound and the display will scroll the message PREHEAT END. The oven will automatically hold that temperature for 30 minutes.
- The oven temperature drops very quickly when the door is opened; however, this should not prevent food from being fully cooked during normal cooking time.
- During convection cooking, the vent fan in the vent hood will automatically turn on at the 1-speed (lowest speed) setting to protect the oven.

OPERATION

TIPS FOR COMBINATION COOKING

This section gives you instructions to operate each combination cooking function. Please read these instructions carefully. Sometimes combination microwave-convection cooking is suggested to get the best cooking results since it shortens the cooking time for foods that normally need a long time to cook. This cooking process also leaves meats juicy on the inside and crispy on the outside. In combination cooking, the convection heat and microwave energy alternate automatically. Your oven has three preprogrammed settings that make it easy to use combination cooking.

HELPFUL HINTS FOR COMBINATION COOKING

1. **Meats** may be roasted directly on the metal rack or in a shallow roasting pan placed on the rack. When using the metal rack, please check your cooking guide for information on proper use.
2. **Less tender** cuts of beef can be roasted and tenderized using oven cooking bags.
3. **When baking**, check for doneness after cooking time is up. If not completely done, let stand in oven for a few minutes to complete cooking.

PRECAUTIONS

1. All cookware used for combination cooking must be BOTH microwave-safe and oven-safe.
2. During combination baking, some baking cookware may cause arcing when it comes in contact with the oven walls or metal accessory racks. Arcing is a discharge of electricity that occurs when microwaves come in contact with metal.
 - If arcing occurs, immediately stop the cooking cycle and place a heat resistant dish between the pan and the metal rack.
 - We recommend you use the metal tray supplied with your oven. It has rubber feet that help prevent arcing.
 - If arcing occurs with other baking cookware, do not use them for combination cooking.

COMBINATION ROAST

Example: To roast with combination cooking for 45 minutes at 400°F.



1. Touch **STOP/CLEAR**.

COMBI.

2. Touch **COMBI**.
(Press once for CO-1.
Press twice for CO-2.)

8
400°F

3. Touch **8**.



4. Touch **START/ENTER**.

4 5 0 0
300°F 325°F 450°F 450°F

5. Touch **4, 5, 0, and 0**.



6. Touch **START/ENTER**.

NOTES:

- The temperature range has 9 steps from 250°F to 450°F.
- During combination cooking, the exhaust fan in the vent hood will automatically turn on at the 1-speed (lowest setting) setting to protect the oven.

TOUCH COMBI PAD	COMBI	CATEGORY	OVEN TEMPERATURE
Once	Co-1	Combination ROAST	Convection 375°F
Twice	Co-2	Combination BAKE	Convection 325°F





OPERATION

SPEED AUTO COMBINATION

This oven can cook food without entering cooking time or power level on combination mode. SPEED AUTO COMBINATION has 4 food categories.

See the SPEED AUTO COMBINATION CHART on this page for the settings available.

For best results, place food on the rack. When cooking meats, use the metal tray/drip pan to catch drippings.

Example: To cook 2 lb. roast pork.	
	1. Touch STOP/CLEAR .
SPEED AUTO COMBI.	2. Touch SPEED AUTO COMBI .
	3. Touch 2 .
	4. Touch 2 and 0 .
	5. Touch START/ENTER .

SPEED AUTO COMBINATION CHART

TOUCH COMBI PAD	CATEGORY	DIRECTION	AMOUNT
1	Whole Chicken	Thoroughly wash inside and outside of chicken with cold water. Pat chicken dry with paper towels, secure the legs with kitchen twine. Brush outside of chicken with melted butter or margarine. Place chicken breast side down on metal rack on metal tray. After cooking, loosely tent chicken with aluminum foil. Let stand for 10 minutes after cooking.	2.0 - 4.0 lbs
2	Roast Pork	Pat dry with paper towels. Place roast on metal rack on metal tray. After cooking, loosely tent roast with aluminum foil and let stand 5 to 10 minute.	2.0 - 4.0 lbs
3	Frozen Lasagna	Remove from outer package. Remove film cover. If lasagna is not in a ovenproof container, place it on a ovenproof dish. Place on metal rack on metal tray. Let stand for 5 minutes after cooking.	10 or 21 oz.
4	Baked Potato	Pierce each potato several times with a fork and place on metal rack on metal tray.	1 - 4 EA

COOKING

CONVECTION BAKING GUIDELINES

- Always use the metal rack when convection baking. Place food directly on rack or place in metal tray and then place tray on rack.
- Aluminum pans conduct heat quickly. For most convection baking, light, shiny finishes give best results because they prevent overbrowning in the time it takes to cook the center areas. Pans with dull (satin-finish) bottoms are recommended for cake pans and pie pans for best bottom browning.
- Dark or non-shiny finishes, glass, and pyroceram absorb heat which may result in dry, crisp crusts.
- Preheating the oven is recommended when baking foods by convection.
- To prevent uneven heating and save energy, open the oven door to check food as little as possible.

FOOD		OVEN TEMP.	TIME, MIN.	COMMENTS
Breads	Refrigerated Biscuits	375°F	11 to 14	Allow additional time for large biscuits.
	Corn Bread	350°F	35 to 40	
	Muffins	425°F	18 to 22	Remove from pans immediately and cool slightly on wire rack.
	Popovers	325°F	45 to 55	Pierce each popover with a fork after removing from oven to allow steam to escape.
	Nut Bread or Fruit Bread	325°F	60 to 70	Interiors will be moist and tender.
	Yeast Bread	375°F	16 to 23	
	Plain or Sweet Rolls	350°F	13 to 16	Lightly grease baking sheet.
Cakes	Devil's Food	350°F	35 to 40	Place cake pan on rack.
	Fudge brownies	350°F	26 to 30	Bake 2 layers of brownies at a time.
	Coffee Cake	325°F	30 to 35	
	Cup Cakes	325°F	20 to 25	
	Fruit Cake (loaf)	275°F	90 to 100	Interior will be moist and tender.
	Gingerbread	300°F	25 to 30	
	Butter Cakes, Cake Mixes	325°F	35 to 45	
	9 x 13a	325°F	35 to 45	Turn end for end half way through baking.
	Tube Cake	325°F	30 to 40	Grease and flour pan.
Pound Cake	325°F	45 to 55	Cool in pan 10 minutes before inverting on wire rack.	
Cookies	Chocolate Chip	350°F	11 to 14	Place metal tray on rack. Allow extra time for frozen cookie dough.
	Sugar	350°F	11 to 14	Place metal tray on rack.
Fruits, Other Desserts	Baked Apples or Pears	350°F	35 to 40	Bake in cookware with shallow sides.
	Bread Pudding	300°F	35 to 40	Pudding is done when knife inserted near center comes out clean.
	Cream Puffs	400°F	30 to 35	Puncture puffs twice with toothpick to release steam after 25 minutes of baking time.
	Meringue Shells	300°F	30 to 35	When done, turn oven off and let shells stand in oven 1 hour to dry.

Notes:

- The oven temperature indicated in the chart above is recommended over the package instruction temperature.
- The baking time in the chart above is only a guideline for your reference. You need to adjust time according to the food condition or your preference. Check doneness at the minimum time.

COOKING

CONVECTION BAKING GUIDELINES (CONT'D)

FOOD		OVEN TEMP.	TIME, MIN.	COMMENTS
Pies, Pastries	Frozen Pie	400°F	50 to 60	Place metal tray on rack and place in cold oven. Preheat oven, tray and rack to 400°F. When preheated, place frozen pie on metal tray and bake according to package time or until crust is browned and filling is hot.
	Meringue-Topped	450°F	9 to 11	Follow package directions for preparation.
	Two-Crust	400°F	50 to 55	Follow package directions for preparation.
	Quiche	350°F	30 to 35	Let stand 5 minutes before cutting.
	Pastry Shell	400°F	10 to 16	Pierce pastry with fork to prevent shrinkage.
Casseroles	Meat, Chicken, Seafood Combinations	350°F	20 to 40	Cook times vary with casserole size and ingredients.
	Pasta	350°F	25 to 45	Cook times vary with casserole size and ingredients.
	Potatoes, scalloped	350°F	55 to 60	Let stand 5 minutes before serving.
	Vegetable	350°F	25 to 35	Cook times vary with casserole size and ingredients.
Convenience Foods	Frozen Bread Dough	350°F	30 to 35	Follow package directions for preparation.
	Frozen Entree	325°F	70 to 80	Follow package directions for preparation.
	Frozen Pizza Rising Crust	400°F	25 to 35	Follow package directions for preparation. Pizza should not extend over the rack.
	Frozen Pizza	400°F	17 to 21	Follow package directions for preparation. Pizza should not extend over the rack.
	French Fries Crinkle Cut	450°F	15 to 19	Follow package directions for preparation.
	Frozen Waffle	400°F	5 to 7	Follow package directions for preparation.
	Frozen Cheese Sticks	450°F	6 to 8	Follow package directions for preparation.
	Frozen Turnovers	450°F	18 to 22	Follow package directions for preparation.
Main Dishes	Meat Loaf	400°F	30 to 40	Let stand 5 minutes after cooking.
	Oven-Baked Stew	325°F	80 to 90	Brown meat before combining with liquid and vegetables.
	Swiss Steak	350°F	60 to 70	Let stand 2 minutes after cooking.
	Stuffed Peppers	350°F	40 to 45	Use green, red, or yellow peppers.
Vegetables	Acorn Squash Halves	375°F	55 to 60	Pierce skin several places. Add 1/2 cup water to dish. Turn squash halves cut side up after 30 minutes of cook time and cover.
	Baked Potatoes	425°F	50 to 60	Pierce skin with fork before baking.
	Twice-Baked Potatoes	400°F	25 to 30	Pierce skin with fork before baking.

Notes:

- The oven temperature indicated in the chart above is recommended over the package instruction temperature.
- The baking time in the chart above is only a guideline for your reference. You need to adjust time according to the food condition or your preference. Check doneness at the minimum time.

COOKING

MEAT ROASTING GUIDELINES FOR CONVECTION COOKING

FOOD		OVEN TEMP.	TIME, MIN./LB.
Beef	Ribs (2 to 4 lbs.)		
	Rare	300°F	45 to 50
	Medium	300°F	50 to 55
	Well	300°F	55 to 60
	Boneless Ribs, Top Sirloin		
	Rare	300°F	53 to 58
	Medium	300°F	58 to 63
	Well	300°F	63 to 68
	Beef Tenderloin		
	Rare	300°F	28 to 32
Medium	300°F	32 to 36	
Ham	Pot Roast (2 ¹ / ₂ to 3 lbs.)		
	Chuck, Rump	300°F	83 to 88
	Meat Loaf (2 lbs.)	400°F	65 to 75
Ham	Canned (3-lb. fully cooked)	325°F	20 to 25
	Butt (5-lb. fully cooked)	325°F	20 to 25
	Shank (5-lb. fully cooked)	325°F	17 to 20
Lamb	Bone-in (2 to 4 lbs.)		
	Medium	300°F	42 to 47
	Well	300°F	47 to 52
	Boneless (2 to 4 lbs.)		
	Medium	300°F	50 to 55
Well	300°F	55 to 60	
Pork	Bone-in (2 to 4 lbs.)	300°F	48 to 52
	Boneless (2 to 4 lbs.)	300°F	56 to 61
	Pork Chops (1/2 to 1-inch thick)		
	2 chops	325°F	42 to 45
	4 chops	325°F	45 to 48
6 chops	325°F	48 to 55	
Poultry	Whole Chicken (2 ¹ / ₂ to 3 ¹ / ₂ lbs.)	375°F	25 to 35
	Chicken Pieces (2 ¹ / ₂ to 3 ¹ / ₂ lbs.)	425°F	10 to 12
	Duckling (4 to 5 lbs.)	375°F	19 to 21
	Turkey Breast (4 to 6 lbs.)	325°F	21 to 25
Seafood	Fish, whole (3 to 5 lbs.)	400°F	13 to 18
	Lobster Tails (6 to 8-oz. each)	350°F	12 to 17

Note:

- The roasting time in the chart above is only a guideline for your reference. You need to adjust time according to the food condition or your preference. Check doneness at the minimum time.

COOKING

COMBINATION ROAST COOKING GUIDE

FOOD		OVEN TEMP.	TIME, MIN./LB.
Beef	Turn over after half of cooking time.		
	Ribs (2 to 4 lbs.)		
	Rare	375°F	9 to 13
	Medium	375°F	11 to 15
	Well	375°F	13 to 17
	Boneless Rib, Top Sirloin		
	Rare	375°F	9 to 13
	Medium	375°F	11 to 15
	Well	375°F	13 to 17
	Beef Tenderloin		
Rare	375°F	16 to 18	
Medium	375°F	18 to 20	
Chuck, Rump or Pot Roast (2½ to 3 lbs.) (Use cooking bag for best results.)	300°F	18 to 20	
Ham	Turn over after half of cooking time.		
	Canned (3-lb. fully cooked)	300°F	15 to 18
	Butt (5-lb. fully cooked) Shank (5-lb. fully cooked)	300°F 300°F	15 to 18 15 to 18
Lamb	Turn over after half of cooking time.		
	Bone-in (2 to 4 lbs.)		
	Medium	300°F	13 to 18
	Well	300°F	18 to 23
	Boneless (2 to 4 lbs.)		
	Medium Well	300°F 300°F	14 to 19 19 to 24
Pork	Turn over after half of cooking time.		
	Bone-in (2 to 4 lbs.)	300°F	17 to 20
	Boneless (2 to 4 lbs.)	300°F	19 to 22
	Pork Chops (¾ to 1-inch thick)		
	2 chops	350°F	10 to 13
	4 chops 6 chops	305°F 305°F	13 to 16 16 to 19
Poultry	Turn over after half of cooking time.		
	Whole Chicken (2½ to 6 lbs.)	375°F	15 to 17
	Chicken Pieces (2½ to 6 lbs.)	375°F	15 to 18
	Cornish Hens (untied)		
	Unstuffed	425°F	15 to 18
	Stuffed	375°F	22 to 25
	Duckling	375°F	15 to 18
Turkey Breast (4 to 6 lbs.)	300°F	11 to 15	
Seafood	Fish		
	1-lb. fillets	350°F	7 to 10
	Lobster Tails (6 to 8-oz. each)	350°F	10 to 15
	Shrimp (1 to 2 lbs.) Scallops (1 to 2 lbs.)	350°F 350°F	9 to 14 8 to 13

Note:

- The roasting time in the chart above is only a guideline for your reference. You need to adjust time according to the food condition or your preference. Check doneness at the minimum time.

COOKING

COMBINATION BAKE COOKING GUIDE

FOOD		OVEN TEMP.	TIME, MIN.	COMMENTS
Pies, Pastries	Quiche	425°F	15 to 17	Let stand 5 minutes before cutting.
Convenience Foods	Frozen Entrée	375°F	39 to 43	Follow package directions for preparation.
	Frozen Pizza Rolls, Egg Rolls	450°F	4 to 6	Follow package directions for preparation.
	Pizza	450°F	23 to 26	Follow package directions for preparation.
Vegetables	Baked Potatoes	450°F	36 to 40	Pierce skin with a fork before baking. Place on rack.

COOKING

HEATING / REHEATING GUIDE

To heat or reheat successfully in a microwave oven, it is important to follow several guidelines. Measure the amount of food in order to determine the time needed to reheat. Arrange the food in a circular pattern for best results. Room temperature food will heat faster than refrigerated food. Canned foods should be taken out of the can and placed in a microwave-safe container. The food will heat more evenly if covered with a microwave-safe lid or vented plastic wrap. Remove cover carefully to prevent steam burns. Use the following chart as a guide for reheating cooked food.

ITEMS	COOK TIME (AT HIGH)	SPECIAL INSTRUCTIONS
Sliced meat 3 slices (1/4 -inch thick)	1-2 minutes	Place sliced meat on microwavable plate. Cover with plastic wrap and vent. Note: Gravy or sauce helps to keep meat juicy.
Chicken pieces 1 breast 1 leg and thigh	2-3 1/2 minutes 1 1/2-3 minutes	Place chicken pieces on microwavable plate. Cover with plastic wrap and vent.
Fish fillet (6-8 oz.)	2-4 minutes	Place fish on microwavable plate. Cover with plastic wrap and vent.
Lasagna 1 serving (10 1/2 oz.)	4-6 minutes	Place lasagna on microwavable plate. Cover with plastic wrap and vent.
Casserole 1 cup 4 cups	1-3 1/2 minutes 5-8 minutes	COOK covered in microwavable casserole. Stir once halfway through cooking.
Casserole – cream or cheese 1 cup 4 cups	1 1/2-3 minutes 3 1/2-5 1/2 minutes	COOK covered in microwavable casserole. Stir once halfway through cooking.
Sloppy Joe or Barbecued Beef 1 sandwich (1/2 cup meat filling)without bun	1-2 1/2 minutes	Reheat filling and bun separately. Cook filling covered in microwavable casserole. Stir once. Heat bun as directed in chart below.
Mashed potatoes 1 cup 4 cups	1-3 minutes 5-8 minutes	COOK covered in microwavable casserole. Stir once halfway through cooking.
Baked beans 1 cup	1 1/2-3 minutes	COOK covered in microwavable casserole. Stir once halfway through cooking.
Ravioli or pasta in sauce 1 cup 4 cups	2 1/2-4 minutes 7 1/2-11 minutes	COOK covered in microwavable casserole. Stir once halfway through cooking.
Rice 1 cup 4 cups	1 1/2-3 1/2 minutes 4-6 1/2 minutes	COOK covered in microwavable casserole. Stir once halfway through cooking.
Sandwich roll or bun 1 roll	15-30 seconds	Wrap in paper towel and place on glass microwavable rack.
Vegetables 1 cup 4 cups	1 1/2-2 1/2 minutes 4-6 minutes	COOK covered in microwavable casserole. Stir once halfway through cooking.
Soup 1 serving (8 oz.)	1 1/2-2 1/2 minutes	COOK covered in microwavable casserole. Stir once halfway through cooking.

COOKING

FRESH VEGETABLE GUIDE

VEGETABLE	AMOUNT	COOK TIME AT HIGH (MINUTE)	INSTRUCTIONS	STANDING TIME
Artichokes (8 oz. each)	2 medium 4 medium	5-8 10-13	Trim. Add 2 tsp water and 2 tsp juice. Cover.	2-3 minutes
Asparagus, Fresh, Spears	1 lb.	3-6	Add 1/2 cup water. Cover.	2-3 minutes
Beans, Green and Wax	1 lb.	7-11	Add 1/2 cup water in 1 1/2 qt. casserole. Stir halfway through cooking.	2-3 minutes
Beets, Fresh	1 lb.	12-16	Add 1/2 cup water in 1 1/2 qt. covered casserole. Rearrange halfway through cooking.	2-3 minutes
Broccoli, Fresh, Spears	1 lb.	4-8	Place broccoli in baking dish. Add 1/2 cup water.	2-3 minutes
Cabbage, Fresh, Chopped	1 lb.	4-7	Add 1/2 cup water in 1 1/2 qt. covered casserole. Stir halfway through cooking.	2-3 minutes
Carrots, Fresh, Sliced	2 cups	2-4	Add 1/4 cup water in 1 qt. covered casserole. Stir halfway through cooking.	2-3 minutes
Cauliflower, Fresh, Whole	1 lb.	7-11	Trim and add 1/4 cup water in 1 qt. covered casserole. Stir halfway through cooking.	2-3 minutes
Flowerettes, Fresh Celery, Fresh, Sliced	2 cups 4 cups	2 1/2-4 1/2 6-8	Slice and add 1/2 cup water in 1 1/2 qt. covered casserole. Stir halfway through cooking.	2-3 minutes
Corn, Fresh	2 ears	5-9	Husk and add 2 tbsp water in 1 1/2 qt. baking dish. Cover.	2-3 minutes
Mushrooms, Fresh, Sliced	1/2 lb.	2-3 1/2	Place mushrooms in 1 1/2 qt. covered casserole. Stir halfway through cooking.	2-3 minutes
Parsnips, Fresh, Sliced	1 lb.	4-8	Add 1/2 cup water in 1 1/2 qt. covered casserole. Stir halfway through cooking.	2-3 minutes
Peas, Green, Fresh	4 cups	7-10	Add 1/2 cup water in 1 1/2 qt. covered casserole. Stir halfway through cooking.	2-3 minutes
Sweet Potatoes Whole Baking (6-8 oz. each)	2 medium 4 medium	5-10 7-13	Pierce potatoes several times with fork. Place on 2 paper towels. Turn over halfway through cooking.	2-3 minutes 2-3 minutes
White Potatoes, Whole Baking (6-8 oz. each)	2 potatoes 4 potatoes	5-8 10-14	Pierce potatoes several times with fork. Place on 2 paper towels. Turn over halfway through cooking.	2-3 minutes 2-3 minutes
Spinach, Fresh, Leaf	1 lb.	4-7	Add 1/2 cup water in 2 qt. covered casserole.	2-3 minutes
Squash, Acorn or Butternut, Fresh	1 medium	6-8	Cut squash in half. Remove seeds. Place in 8 x 8-inch baking dish. Cover.	2-3 minutes
Zucchini, Fresh, Sliced	1 lb.	4 1/2-7 1/2	Add 1/2 cup water in 1 1/2 qt. covered casserole. Stir halfway through cooking.	2-3 minutes
Zucchini, Fresh, Whole	1 lb.	6-9	Pierce. Place on 2 paper towels. Turn over and rearrange halfway through cooking.	2-3 minutes

MAINTENANCE

CARING FOR YOUR MICROWAVE OVEN

To make sure your microwave oven looks good and works well for a long time, you should maintain it properly. For proper care, please follow these instructions carefully.

For interior surfaces: Wash often with warm, sudsy water and a sponge or soft cloth. Use only mild, nonabrasive soaps or a mild detergent. **Be sure to keep the areas clean where the door and oven frame touch when closed.** Wipe well with clean cloth. Over time, stains can occur on the surfaces as the result of food particles spattering during cooking. This is normal.

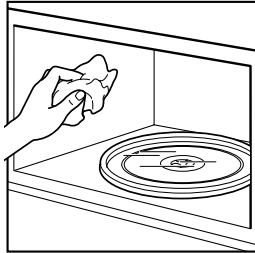

For stubborn soil, boil a cup of water in the oven for 2 to 3 minutes. Steam will soften the soil. To get rid of odors inside the oven, boil a cup of water with some lemon juice or vinegar in it.

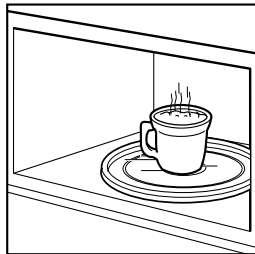

For exterior surfaces and control panel: Use a soft cloth with spray glass cleaner. Apply the spray glass cleaner to the soft cloth; do not spray directly on the oven.

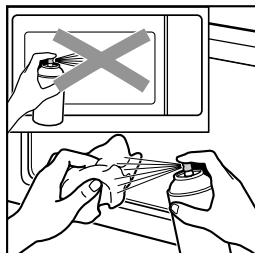

NOTE: Abrasive cleansers, steel wool pads, gritty wash cloths, some paper towels, etc., can damage the control panel and the interior and exterior oven surfaces.

To clean glass tray and rotating ring, wash in mild, sudsy water; for heavily soiled areas use a mild cleanser and scouring sponge. The glass tray and rotating ring are dishwasher safe.

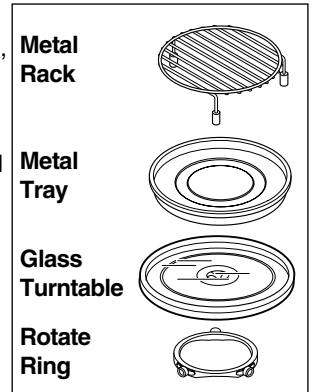

MAINTENANCE

CLEANING THE GREASE FILTERS

1. **Unplug** the microwave oven.
2. **To remove** grease filters, slide each filter to the side. Pull filters downward and push to the other side. The filter will drop out.

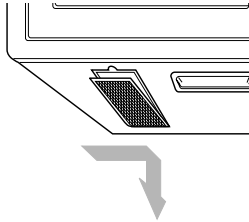

3. **Soak** grease filters in hot water and a mild detergent. **Scrub and swish** to remove embedded dirt and grease. **Rinse well and shake** to dry. **Do not clean filters with ammonia, corrosive cleaning agents such as lye-based oven cleaners, or place them in a dishwasher. The filters will turn black or could be damaged.**

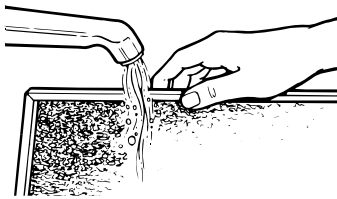

4. To replace grease filters, slide filter in the frame slot on one side of the opening. Push filter upward and

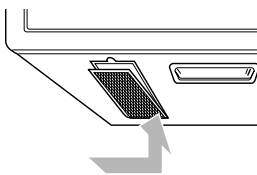

push to the other side to lock into place.

5. **Plug in** the microwave oven.

CHARCOAL FILTER REPLACEMENT

If your oven is vented inside, the charcoal filter should be replaced every 6 to 12 months, and more often if necessary. The charcoal filter cannot be cleaned. To order a new charcoal filter, contact the Parts Department at your nearest Authorized Service Center.

1. **Unplug** the microwave oven.
2. **Remove** the two vent grille mounting screws.

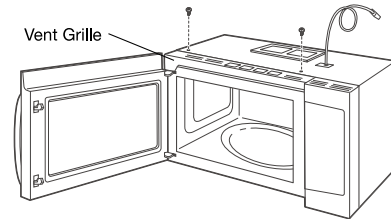

3. **Tip** the grille forward, then lift out to remove.
4. Remove the bulb holder

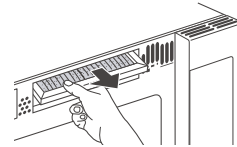

5. **Slide** a new charcoal filter into place. The filter should rest at the angle shown.

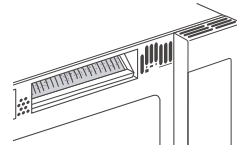

6. **Slide** the bottom of the vent grille into place. **Push** the top until it snaps into place. **Replace** the mounting screws.
7. **Plug in** the microwave oven.

MAINTENANCE

COOKTOP/COUNTERTOP LIGHT REPLACEMENT

1. **Unplug** the microwave oven.

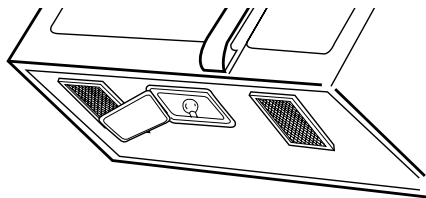

2. **Remove** the bulb cover mounting screws.
3. Replace bulb(s) with candelabra-base 20 watt bulb.
4. Replace bulb cover and mounting screw.
5. **Plug** in the microwave oven.

OVEN LIGHT REPLACEMENT

1. **Unplug** the microwave oven.
2. **Remove** the vent grille mounting screws.
3. **Tip** the cover forward, then **lift out** to remove.

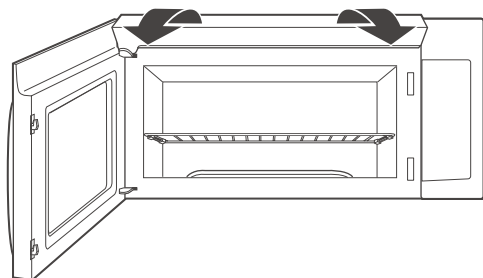

4. **Lift up** the bulb holder.

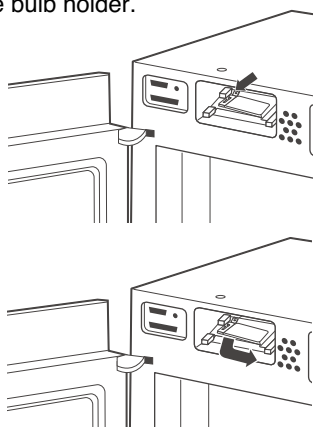

5. **Replace** the bulb with a candelabra-base 20 watt bulb.
6. **Replace** the bulb holder, if damaged.
7. Slide the bottom of the vent grille into place. **Push** the bottom until it snaps into place. **Replace** the mounting screws.
8. **Plug** in the microwave oven.

QUESTIONS AND ANSWERS

Q. Can I use a rack in my microwave oven so that I may reheat or cook in two levels at a time?

A. Only use the rack that is supplied with your microwave oven. Use of any other rack can result in poor cooking performance and/or arcing and may damage your oven.

Q. Can I use either metal or aluminum pans in my microwave oven?

A. Usable metal includes aluminum foil for shielding (use small, flat pieces), and shallow foil trays (if tray is 3/4 inch deep and filled with food to absorb microwave energy). Never allow metal to touch walls or door.

Q. Sometimes the door of my microwave oven appears wavy. Is this normal?

A. This appearance is normal and does not affect the operation of your oven.

Q. The glass tray does not move.

A. • The glass tray is not correctly in place. It should be correct-side up and sitting firmly on the center hub.
• The support is not operating correctly. Remove the glass tray and restart the oven. Cooking without the glass tray can give you poor results.

Q. Why does the dish become hot when I microwave food in it? I thought that this should not happen.

A. As the food becomes hot it will conduct the heat to the dish. Use hot pads to remove food after cooking.

Q. What does standing time mean?

A. Standing time means that food should be taken out of the oven and covered for additional time after cooking. This process allows the cooking to finish, saves energy, and frees the oven for other purpose.

Q. Can I pop popcorn in my microwave oven? How do I get the best results?

A. Yes. Pop packaged microwave popcorn following manufacturer's guidelines or use the preprogrammed Popcorn pad.
Do not use regular paper bags. Use the listening test by stopping the oven as soon as the popping slows to a pop every one or two seconds. Do not try to repop unpopped kernels. You can also use special microwave poppers. When using a popper, be sure to follow manufacturer's directions. Do not pop popcorn in glass utensils.

Q. Why does steam come out of the air exhaust vent?

A. Steam is normally produced during cooking. The microwave oven has been designed to vent this steam out the top vent.

MAINTENANCE

MICROWAVE UTENSIL GUIDE

USE	DO NOT USE
<p>OVENPROOF GLASS (treated for high intensity heat): utility dishes, loaf dishes, pie plates, cake plates, liquid measuring cups, casseroles and bowls without metallic trim.</p> <p>CHINA: bowls, cups, serving plates, and platters without metallic trim.</p> <p>PLASTIC: Plastic wrap (as a cover)-- lay the plastic wrap loosely over the dish and press it to the sides. Vent plastic wrap by turning back one edge slightly to allow excess steam to escape. The dish should be deep enough so that the plastic wrap will not touch the food. As the food heats it may melt the plastic wrap wherever the wrap touches the food. Use plastic dishes, cups, semi-rigid freezer containers and plastic bags only for short cooking time. Use these with care because the plastic may soften from the heat of the food.</p> <p>PAPER: Paper towels, waxed paper, paper napkins, and paper plates with no metallic trim or design. Look for the manufacturer's label for use in the microwave oven.</p> <p>NOTE: Do not use recycled paper products in the microwave oven. They sometimes contain impurities that cause arcing and sparking.</p> <p>NEVER use paper products in the convection oven.</p>	<p>METAL UTENSILS: Metal shields the food from microwave energy and produces uneven cooking. Also avoid metal skewers, thermometers, or foil trays. Metal utensils can cause arcing, which can damage your microwave oven.</p> <p>METAL DECORATION: Metal-trimmed or metal-banded dinnerware, casserole dishes, etc. The metal trim interferes with normal cooking and may damage the oven.</p> <p>ALUMINUM FOIL: Avoid large sheets of aluminum foil because they hinder cooking and may cause harmful arcing. Use small pieces of foil to shield poultry legs and wings. Keep ALL aluminum foil at least 1 inch from the side walls and door of the oven.</p> <p>WOOD: Wooden bowls and boards will dry out and may split or crack when you use them in the microwave oven. Baskets react in the same way.</p> <p>TIGHTLY COVERED UTENSILS: Be sure to leave openings for steam to escape from covered utensils. Pierce plastic pouches of vegetables or other food items before cooking. Tightly closed pouches could explode.</p> <p>BROWN PAPER: Avoid using brown paper bags. They absorb too much heat and could burn.</p> <p>FLAWED OR CHIPPED UTENSILS: Any utensil that is cracked, flawed, or chipped may break in the oven.</p> <p>METAL TWIST TIES: Remove metal twist ties from plastic or paper bags. They become hot and could cause a fire.</p>

TROUBLESHOOTING

BEFORE CALLING FOR SERVICE

Check the following list to be sure a service call is really necessary. A quick reference of this manual as well as reviewing additional information on items to check may prevent an unneeded service call.

If nothing on the oven operates:

- check for a blown circuit fuse or a tripped main circuit breaker.
- check if oven is properly connected to electric circuit in house.
- check that controls are set properly.

If the oven interior light does not work:

- the light bulb is loose or defective.

If oven will not cook:

- check that control panel was programmed correctly.
- check that door is firmly closed.
- check that **Start** was pressed.
- check that probe was inserted correctly into receptacle.
- check that timer wasn't started instead of a cook function.

If oven takes longer than normal to cook or cooks too rapidly:

- be sure the Power Level is programmed properly.

If the time of day clock does not always keep correct time:

- check that the power cord is fully inserted into the outlet receptacle.
- be sure the oven is the only appliance on the electrical circuit.

If food cooks unevenly:

- be sure food is evenly shaped.
- be sure food is completely defrosted before cooking.
- check placement of aluminum foil strips used to prevent overcooking.

If food is undercooked:

- check recipe to be sure all directions (amount, time, and power levels) were correctly followed.
- be sure microwave oven is on a separate circuit.
- be sure food is completely defrosted before cooking.

If food is overcooked:

- check recipe to be sure all directions (amount, power level, time, size of dish) were followed.

If arcing (sparks) occur:

- be sure microwavable dishes were used.
- be sure wire twist ties weren't used.
- be sure oven wasn't operated when empty.
- make sure metal rack (if used) is properly installed on 4 supports.

If the Display shows a time counting down but the oven is not cooking:

- check that door is firmly closed.
- check that timer wasn't started instead of a cooking function.

MEMO

MEMO

MEMO



LG MICROWAVE OVEN LIMITED WARRANTY – USA

Model LMVH1711ST

LG Electronics, Inc. will repair or replace your product, at LG's option, if it proves to be defective in material or workmanship under normal use, during the warranty period set forth below, effective from the date of original consumer purchase of the product. This warranty is good only to the original purchaser of the product and effective only when used in the United States, including U.S. Territories.

<p><u>WARRANTY PERIOD:</u></p> <p>LABOR: One Year from the Date of Purchase*.</p> <p>PARTS (except as listed below): One Year from the Date of Purchase*.</p> <p>MAGNETRON: Ten Years from the Date of Purchase*.</p> <p>Replacement Units and Repair Parts are warranted for the remaining portion of the original unit's warranty period.</p> <p>* Retain your Sales Receipt to prove the date of purchase. A copy of your Sales Receipt must be submitted at the time warranty service is provided.</p>	<p><u>HOW SERVICE IS HANDLED:</u></p> <p>Please call 1-800-243-0000 and choose the appropriate option. (Phones are answered 24 hours a day, 365 days per year.) Please have the product type (Microwave) and your ZIP code ready.</p> <p>Or visit our website at: www.lg.com</p>
--	--

THIS WARRANTY IS IN LIEU OF ANY OTHER WARRANTY, EXPRESS OR IMPLIED, INCLUDING WITHOUT LIMITATION, ANY WARRANTY OF MERCHANTABILITY OR FITNESS FOR A PARTICULAR PURPOSE. TO THE EXTENT ANY IMPLIED WARRANTY IS REQUIRED BY LAW, IT IS LIMITED IN DURATION TO THE EXPRESS WARRANTY PERIOD ABOVE. LG WILL NOT BE LIABLE FOR ANY INCIDENTAL, CONSEQUENTIAL, INDIRECT, SPECIAL, OR PUNITIVE DAMAGES OF ANY NATURE, INCLUDING WITHOUT LIMITATION, LOST REVENUES OR PROFITS, OR ANY OTHER DAMAGE WHETHER BASED IN CONTRACT, TORT, OR OTHERWISE. Some states do not allow the exclusion or limitation of incidental or consequential damages or limitations on how long an implied warranty lasts, so the above exclusion or limitation may not apply to you. This warranty gives you specific legal rights and you may also have other rights that vary from state to state.

THIS LIMITED WARRANTY DOES NOT APPLY TO:

- Service trips to your home to deliver, pick up, and/or install the product, instruct, or replace house fuses or correct wiring, or correction of unauthorized repairs.
- Damages or operating problems that result from misuse, abuse, operation outside environmental specifications or contrary to the requirements of precautions in the Operating Guide, accident, vermin, fire, flood, improper installation, acts of God, unauthorized modification or alteration, incorrect electrical current or voltage, or commercial use, or use for other than intended purpose.

The cost of repair or replacement under these excluded circumstances shall be borne by the consumer.

CUSTOMER INTERACTIVE CENTER NUMBERS

<p>To obtain Customer Assistance, Product Information, or Dealer or Authorized Service Center location:</p>	<p>Call 1-800-243-0000 (24 hours a day, 365 days per year) and select the appropriate option from the menu.</p> <p>Or visit our website at: www.lg.com</p>
--	--

TO CONTACT LG ELECTRONICS BY MAIL:

LG Customer Interactive Center
P. O. Box 240007
201 James Record Road
Huntsville, Alabama 35824
ATTN: CIC



LG Customer Information Center

1-800-243-0000 USA, Consumer User

1-888-865-3026 USA, Commercial User

Register your product Online!

www.lg.com