

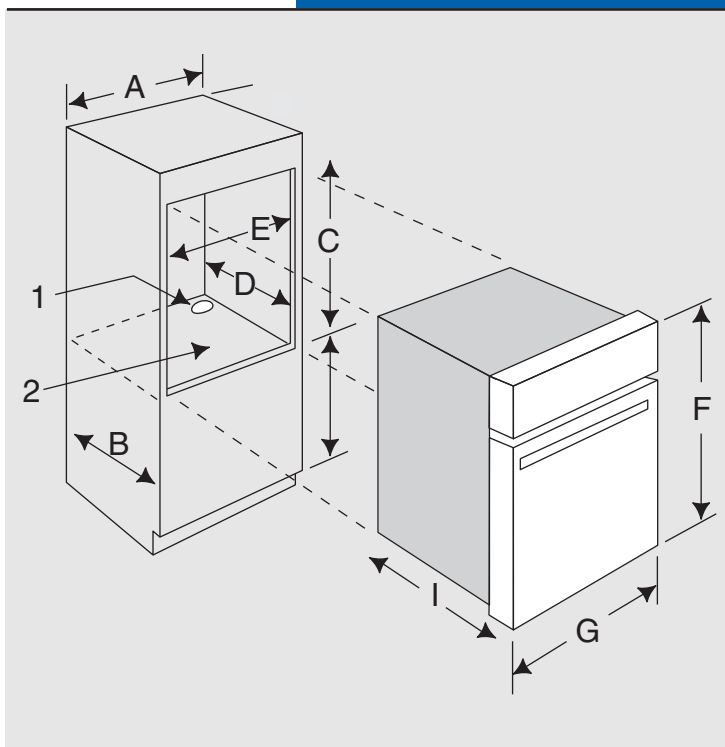

27"

SINGLE ELECTRIC WALL OVEN



Dimensions

■	Inches	Centimeters
A	27 minimum	68.6 minimum
B	24 minimum	61.0 minimum
C	27 7/8	70.8
D	24	61
E	25 1/2	64.8
F	28 1/4	71.8
G	26 3/4	67.9
H	4 to 33 above floor	10.2 to 83.8 above floor
I	24 7/16	62.1

Notes:

1. □1 1/4" diameter conduit access hole.
2. □5/8" plywood floor (must support 142 lbs.).

Important: Because of continuing product improvements, Maytag reserves the right to change specifications without notice. Dimensional specifications are provided for planning purposes only. For complete details see installation instructions that accompany each product before selecting cabinetry, making cutouts or beginning installation.