

Electric Coil & Radiant RANGES

Safety Information 2-6

Operating Instructions

Clock, Timer and Convenience Outlet 15, 16
Controls 10, 11
Cookware 9
Oven 12-14
Sabbath Feature 19, 20
Self-Cleaning 22, 23
Special Features 18
Surface Units 7, 8
Temperature Conversions 11
Thermostat 21
Timed Baking and Roasting 17

Care and Cleaning 24-30

Installation Instructions 31-34

Troubleshooting Tips 35-39

Accessories 40

Consumer Support

Consumer Support 44
Product Registration 41, 42
Warranty 43

***Owner's Manual and
Installation Instructions***

*Coil Top and
Radiant Top Models*

***Write the model and serial
numbers here:***

Model # _____

Serial # _____

You can find them on a label,
behind the storage drawer on the
oven frame.

IMPORTANT SAFETY INFORMATION. READ ALL INSTRUCTIONS BEFORE USING.

⚠ WARNING!

For your safety, the information in this manual must be followed to minimize the risk of fire or explosion, electric shock, or to prevent property damage, personal injury, or loss of life.



⚠ WARNING ANTI-TIP DEVICE

All ranges can tip and injury could result.

To prevent accidental tipping of the range, attach it to the wall by installing the Anti-Tip device supplied.

If the Anti-Tip device supplied with the range does not fit this application, use the universal Anti-Tip device WB2X7909.

To check if the device is installed and engaged properly, carefully tip the range forward. The Anti-Tip device should engage and prevent the range from tipping over.

If you pull the range out from the wall for any reason, make sure the device is properly engaged when you push the range back against the wall. If it is not, there is a possible risk of the range tipping over and causing injury if you or a child stand, sit or lean on an open door.

Please refer to the Anti-Tip device information in this manual. Failure to take this precaution could result in tipping of the range and injury.



SAFETY PRECAUTIONS

When using electrical appliances, basic safety precautions should be followed, including the following:

- Use this appliance only for its intended purpose as described in this Owner's Manual.
- Be sure your appliance is properly installed and grounded by a qualified technician in accordance with the provided installation instructions.
- Do not attempt to repair or replace any part of your range unless it is specifically recommended in this manual. All other servicing should be referred to a qualified technician.
- Before performing any service, disconnect the range power supply at the household distribution panel by removing the fuse or switching off the circuit breaker.
- Do not leave children alone—children should not be left alone or unattended in an area where an appliance is in use. They should never be allowed to sit or stand on any part of the appliance.
- Do not allow anyone to climb, stand or hang on the door, storage drawer, or cooktop. They could damage the range and even tip it over, causing severe personal injury.
- Do not store flammable materials in an oven or near the cooktop.
- **CAUTION:** Items of interest to children should not be stored in cabinets above a range or on the backsplash of a range—children climbing on the range to reach items could be seriously injured.



COOK MEAT AND POULTRY THOROUGHLY...

Cook meat and poultry thoroughly—meat to at least an INTERNAL temperature of 160°F and poultry to at least an INTERNAL temperature of 180°F. Cooking to these temperatures usually protects against foodborne illness.



⚠️ **WARNING!** SAFETY PRECAUTIONS

- Never wear loose-fitting or hanging garments while using the appliance. Be careful when reaching for items stored over the range. Flammable material could be ignited if brought in contact with hot surface units or heating elements and may cause severe burns.
 - Use only dry pot holders—moist or damp pot holders on hot surfaces may result in burns from steam. Do not let pot holders touch hot surface units or heating elements. Do not use a towel or other bulky cloth.
 - For your safety, never use your appliance for warming or heating the room.
 - Do not let cooking grease or other flammable materials accumulate in or near the range.
 - Do not use water on grease fires. Never pick up a flaming pan. Turn the controls off. Smother a flaming pan on a surface unit by covering the pan completely with a well-fitting lid, cookie sheet or flat tray. Use a multi-purpose dry chemical or foam-type fire extinguisher.
- Flaming grease outside a pan can be put out by covering it with baking soda or, if available, by using a multi-purpose dry chemical or foam-type fire extinguisher.
- Flame in the oven can be smothered completely by closing the door and turning the oven off or by using a multi-purpose dry chemical or foam-type fire extinguisher.
- Do not touch the surface units, the heating elements or the interior surface of the oven. These surfaces may be hot enough to burn even though they are dark in color. During and after use, do not touch, or let clothing or other flammable materials contact, the surface units, areas nearby the surface units or any interior area of the oven; allow sufficient time for cooling first.
- Potentially hot surfaces include the cooktop, areas facing the cooktop, oven vent opening, surfaces near the opening, crevices around the oven door and metal trim parts above the door.
- REMEMBER:** The inside surface of the oven may be hot when the door is opened.
- Do not store or use combustible materials, gasoline or other flammable vapors and liquids in the vicinity of this or any other appliance.
 - Keep the hood and grease filters clean to maintain good venting and to avoid grease fires.
 - Never block the vents (air openings) of the range. They provide the air inlet and outlet that are necessary for the range to operate properly with correct combustion. Air openings are located at the rear of the cooktop, at the top and bottom of the oven door, and at the bottom of the range under the storage drawer.

IMPORTANT SAFETY INFORMATION.

READ ALL INSTRUCTIONS BEFORE USING.



OVEN

- Stand away from the range when opening the oven door. Hot air or steam which escapes can cause burns to hands, face and/or eyes.
- Do not heat unopened food containers. Pressure could build up and the container could burst, causing an injury.
- Keep the oven vent unobstructed.
- Keep the oven free from grease buildup.
- Place the oven shelf in the desired position while the oven is cool. If shelves must be handled when hot, do not let pot holder contact the heating elements.
- Pulling out the shelf to the stop-lock is a convenience in lifting heavy foods. It is also a precaution against burns from touching hot surfaces of the door or oven walls.
- When using cooking or roasting bags in the oven, follow the manufacturer's directions.
- Do not use the oven to dry newspapers. If overheated, they can catch on fire.
- Do not use the oven for a storage area. Items stored in an oven can ignite.
- Do not leave paper products, cooking utensils or food in the oven when not in use.



SELF-CLEANING OVEN *(on some models)*

- Do not clean the door gasket. The door gasket is essential for a good seal. Care should be taken not to rub, damage or move the gasket.
- Clean only parts listed in this Owner's Manual.
- Do not use oven cleaners on self-clean models. No commercial oven cleaner or oven liner protective coating of any kind should be used in or around any part of the oven. Residue from oven cleaners will damage the inside of the oven when the self-clean cycle is used.
- Before self-cleaning the oven, remove any broiler pan, grid and other cookware.
- Be sure to wipe up excess spillage before starting the self-cleaning operation.
- If the self-cleaning mode malfunctions, turn the oven off and disconnect the power supply. Have it serviced by a qualified technician.
- Take the shelves out of the oven before you begin the self-clean cycle or they may discolor.



SURFACE UNITS—ALL MODELS

Use proper pan size—select cookware having flat bottoms large enough to cover the surface unit heating element. The use of undersized cookware will expose a portion of the surface unit to direct contact and may result in ignition of clothing. Proper relationship of cookware to surface unit will also improve efficiency.

- Never leave the surface units unattended at high heat settings. Boilovers cause smoking and greasy spillovers that may catch on fire.
- Only certain types of glass, glass/ceramic, earthenware or other glazed containers are suitable for cooktop service; others may break because of the sudden change in temperature.
- To minimize the possibility of burns, ignition of flammable materials and spillage, the handle of a container should be turned toward the center of the range without extending over nearby surface units.
- Always turn the surface units off before removing cookware.
- Do not flame foods on the cooktop. If you do flame foods under the hood, turn the fan on.
- Keep an eye on foods being fried at high or medium high heat settings.
- Foods for frying should be as dry as possible. Frost on frozen foods or moisture on fresh foods can cause hot fat to bubble up and over the sides of the pan.
- Use little fat for effective shallow or deep fat frying. Filling the pan too full of fat can cause spillovers when food is added.
- If a combination of oils or fats will be used in frying, stir together before heating, or as fats melt slowly.
- Always heat fat slowly, and watch as it heats.
- Use a deep fat thermometer whenever possible to prevent overheating fat beyond the smoking point.

IMPORTANT SAFETY INFORMATION. READ ALL INSTRUCTIONS BEFORE USING.

Safety Instructions



⚠ WARNING! RADIANT SURFACE UNITS *(on some models)*

Use care when touching the cooktop. The glass surface of the cooktop will retain heat after the controls have been turned off.

- Avoid scratching the glass cooktop. The cooktop can be scratched with items such as sharp instruments, rings or other jewelry and rivets on clothing.
- Large scratches or impacts to glass doors or cooktops can lead to broken or shattered glass.
- Do not operate the radiant surface units if the glass is broken. Spillovers or cleaning solution may penetrate a broken cooktop and create a risk of electrical shock. Contact a qualified technician immediately should your glass cooktop become broken.
- Never use the glass cooktop surface as a cutting board.
- Do not place or store items that can melt or catch fire on the glass cooktop, even when it is not being used.
- Be careful when placing spoons or other stirring utensils on the glass cooktop surface when it is in use. They may become hot and could cause burns.
- Clean the cooktop with caution. If a wet sponge or cloth is used to wipe spills on a hot surface unit, be careful to avoid steam burns. Some cleaners can produce noxious fumes if applied to a hot surface.
- **NOTE:** We recommend that you avoid wiping any surface unit areas until they have cooled and the indicator light has gone off. Sugar spills are the exception to this. Please see *Cleaning the glass cooktop* section.
- When the cooktop is cool, use only the recommended cleaning cream to clean the cooktop.
- To avoid possible damage to the cooking surface, do not apply cleaning cream to the glass surface when it is hot.
- After cleaning, use a dry cloth or paper towel to remove all cleaning cream residue.
- Read and follow all instructions and warnings on the cleaning cream labels.
- Do not lift the cooktop. Lifting the cooktop can lead to damage and improper operation of the range.

Operating Instructions

Care and Cleaning

Installation Instructions



⚠ WARNING! COIL SURFACE UNITS *(on some models)*

- Clean the cooktop with caution. If a wet sponge is used to wipe spills on a hot cooktop, be careful to avoid steam burns.
- To avoid the possibility of a burn or electric shock, always be certain that the controls for all surface units are at the **OFF** position and all coils are cool before attempting to lift or remove a unit.
- Do not immerse or soak the removable surface units. Do not put them in a dishwasher.
- Be sure the drip pans and the vent duct are not covered and are in place. Their absence during cooking could damage range parts and wiring.
- Do not use aluminum foil to line the drip pans or anywhere in the oven except as described in this manual. Misuse could result in a shock, fire hazard or damage to the range.

Troubleshooting Tips

Consumer Support



READ AND FOLLOW THIS SAFETY INFORMATION CAREFULLY.
SAVE THESE INSTRUCTIONS

Using the surface units.

Throughout this manual, features and appearance may vary from your model.

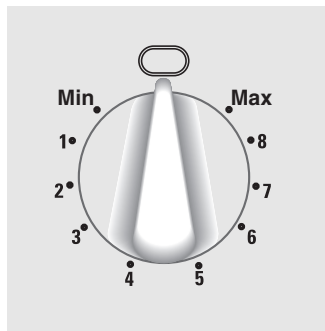

How to Set

Push the knob in and turn in either direction to the setting you want.

At both **OFF** and **Max** the control **clicks** into position. You may hear slight **clicking** sounds during cooking, indicating the control is keeping the power level you set.

Be sure you turn the control knob to **OFF** when you finish cooking.

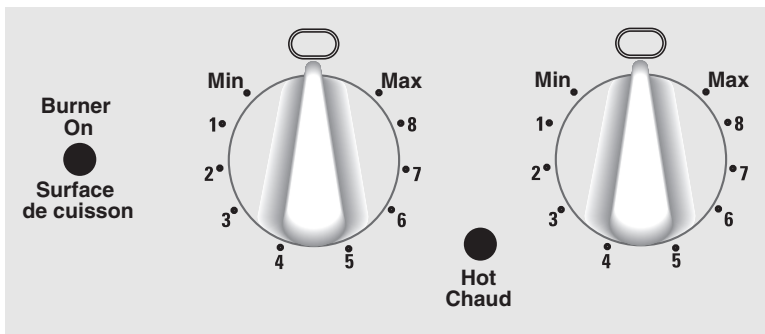

Indicator Lights (on radiant glass models only)

A **Hot** indicator light will glow when any radiant element is turned on, and will remain on until the surface is cool enough to touch.

A **Burner On** indicator light will glow when any surface unit is on.

NOTE: The **Hot** indicator light may glow between the surface control settings of **Min** and **OFF**, but there is no power to the surface units.

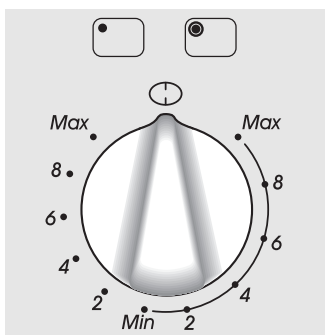

Dual Surface Unit Control Knob (on some radiant glass models only)

The left rear and the right front surface units have 2 cooking sizes (5" and 8") to select from so you can match the size of the unit to the size of the cookware you are using.

To use the small surface unit, turn the control knob to the small burner setting.

To use the large surface unit, turn the control knob to the large burner setting.

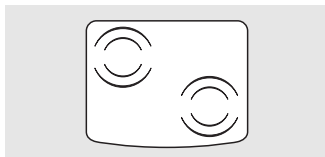
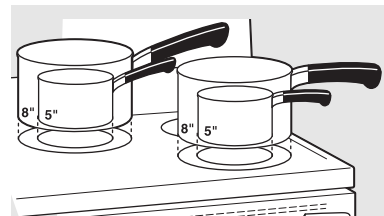

Using the radiant surface units. *(on some models)*



Never cook directly on the glass.
Always use cookware.

About the radiant surface units...

The radiant cooktop features heating units beneath a smooth glass surface.

NOTE: A slight odor is normal when a new cooktop is used for the first time. It is caused by the heating of new parts and insulating materials and will disappear in a short time.

The surface unit will cycle on and off to maintain your selected control setting.

It is safe to place hot cookware from the oven or surface on the glass surface when the surface is cool.

Even after the surface units are turned off, the glass cooktop retains enough heat to continue cooking. To avoid over-cooking, remove pans from the surface units when the food is cooked. Avoid placing anything on the surface unit until it has cooled completely.

Do not slide cookware across the cooktop because it can scratch the glass—the glass is scratch resistant, not scratch proof.

- Water stains (mineral deposits) are removable using the cleaning cream or full-strength white vinegar.
- Use of window cleaner may leave an iridescent film on the cooktop. The cleaning cream will remove this discoloration.
- Don't store heavy items above the cooktop. If they drop onto the cooktop, they can cause damage.
- Do not use the surface as a cutting board.



Always place the pan in the center of the surface unit you are cooking on.

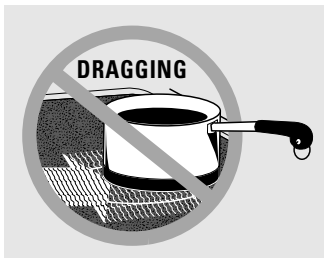

Temperature Limiter

Every radiant surface unit has a temperature limiter.

The temperature limiter protects the glass cooktop from getting too hot.

The temperature limiter may cycle the units off for a time if:

- The pan boils dry.
- The pan bottom is not flat.
- The pan is off center.
- There is no pan on the unit.

Selecting types of cookware.

The following information will help you choose cookware which will give good performance on glass cooktops.

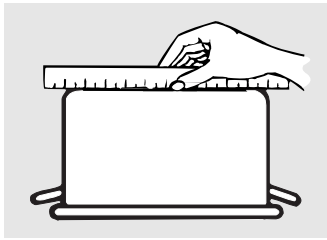

Check pans for flat bottoms by using a straight edge.

Stainless Steel:

recommended

Aluminum:

heavy weight recommended

Good conductivity. Aluminum residues sometimes appear as scratches on the cooktop, but can be removed if cleaned immediately. Because of its low melting point, thin-weight aluminum should not be used.

Copper Bottom:

recommended

Copper may leave residues which can appear as scratches. The residues can be removed, as long as the cooktop is cleaned immediately. However, do not let these pots boil dry. Overheated metal can bond to glass cooktops. An overheated copper bottom pot will leave a residue that will permanently stain the cooktop if not removed immediately.

Porcelain Enamel Covered Cast Iron:

recommended

As long as the cookware is covered completely with porcelain enamel, this cookware is recommended. Caution is recommended for cast-iron cookware that is not completely covered with smooth porcelain enamel, as it may scratch the glass-ceramic cooktop.

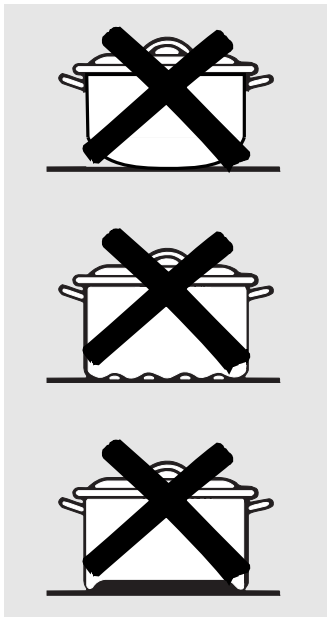

Pans with rounded, curved, ridged or warped bottoms are not recommended.

Glass-ceramic:

usable, but not recommended

Poor performance. May scratch the surface.

Stoneware:

usable, but not recommended

Poor performance. May scratch the surface.

Home Canning Tips:

Be sure the canner is centered over the surface unit.

Make sure the canner is flat on the bottom.

Use recipes and procedures from reputable sources. These are available from manufacturers such as Ball® and Kerr® and the Department of Agriculture Extension Service.

To prevent burns from steam or heat, use caution when canning.

The following information will help you choose cookware which will give good performance on coil cooktops.

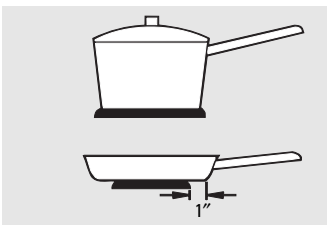

Not over 1 inch

Surface Cookware Tips

Use medium- or heavy-weight cookware. Aluminum cookware conducts heat faster than other metals. Cast-iron and coated cast-iron cookware are slow to absorb heat, but generally cook evenly at low to medium heat settings. Steel pans may cook unevenly if not combined with other metals.

For best cooking results, pans should be flat on the bottom. Match the size of the saucepan to the size of the surface unit. The pan should not extend over the edge of the surface unit more than 1 inch.

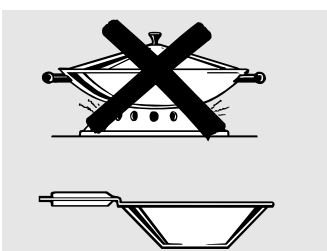

Use only flat-bottomed woks.

Wok Cooking

We recommend that you use only a flat-bottomed wok. They are available at your local retail store.

Do not use woks that have support rings. Use of these types of woks, with or without the ring in place, can be dangerous.

Placing the ring over the surface unit will cause a buildup of heat that will damage the porcelain cooktop. Do not try to use such woks without the ring. You could be seriously burned if the wok tips over.

Using the oven controls. *(on some models)*

Throughout this manual, features and appearance may vary from your model.

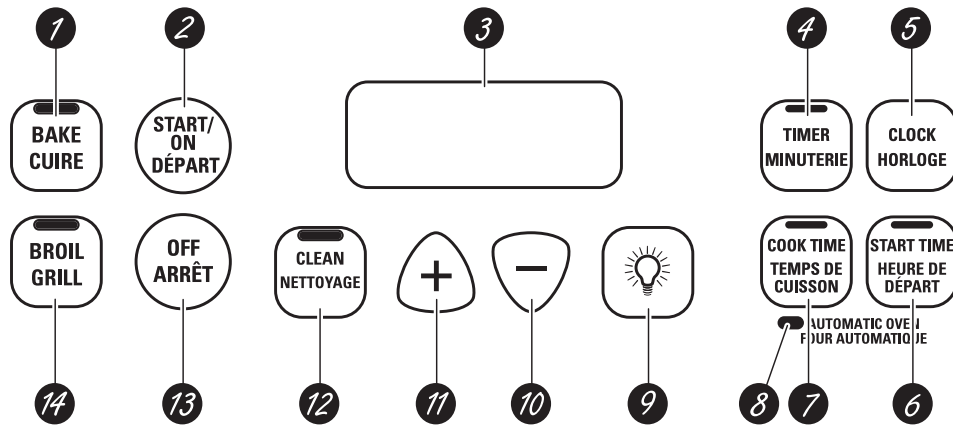

Oven Control, Clock and Timer Features and Settings

- 1 BAKE Pad**
Touch this pad to select the bake function.
BAKE Light
Flashes while in edit mode—you can change the oven temperature at this point. Glows when the oven is in bake mode.
- 2 START/ON Pad**
Must be touched to start any cooking or cleaning function.
- 3 Display**
Shows the time of day, oven temperature, whether the oven is in the bake, broil or self-cleaning mode and the times set for the timer or automatic oven operations. The display will show **PRE** while preheating. When the oven reaches the selected temperature, the oven control will beep and the display will show the oven temperature.
- If “F– and a number or letter” flash in the display and the oven control signals, this indicates a function error code.*
If your oven was set for a timed oven operation and a power outage occurred, the clock and all programmed functions must be reset.
The time of day will flash in the display when there has been a power outage. Reset the clock.
If the function error code appears during the self-cleaning cycle, check the oven door latch. The latch handle may have been moved, even if only slightly, from the latched position. Make sure the latch is moved to the right as far as it will go.
Touch the OFF pad. Allow the oven to cool for one hour. Put the oven back into operation. If the function error code repeats, disconnect the power to the range and call for service.
- 4 TIMER Pad**
Touch this pad to select the timer feature. Then touch the **+** and **–** pads to adjust the timer.
TIMER Light
Flashes while in edit mode—you can change the set time at this point. Glows when the timer has been activated. Flashes again when the time has run out until the control is reset.
- 5 CLOCK Pad**
To set the clock, press this pad twice and then press the **+** and **–** pads. The time of day will flash in the display when the oven is first turned on.
- 6 START TIME Pad (on some models)**
Use along with the **COOK TIME** or **CLEAN** pads to set the oven to start and stop automatically at a time you set.
START TIME Light
Flashes while in edit mode—you can change the start time at this point. Glows when the function has been activated.
- 7 COOK TIME Pad (on some models)**
Touch this pad and then touch the **+** or **–** pads to set the amount of time you want your food to cook. The oven will shut off when the cooking time has run out.
COOK TIME Light
Flashes while in edit mode—you can change the set time at this point. Glows when the function has been activated. Flashes again when the time has run out until the control is reset.



Oven Control, Clock and Timer Features and Settings

8 **AUTOMATIC OVEN Light** (on some models)

This lights anytime the oven has been programmed using the **COOK TIME** or **START TIME** functions.

9 **OVEN LIGHT** or ☀ Pad

Touch this pad to turn the oven light on or off.

10 **- Pad**

Short taps to this pad will decrease the time or temperature by small amounts. Touch and hold the pad to decrease the time or temperature by larger amounts.

11 **+ Pad**

Short taps to this pad will increase the time or temperature by small amounts. Touch and hold the pad to increase the time or temperature by larger amounts.

12 **CLEAN Pad** (on some models)

Touch this pad to select the self-cleaning function. See the *Using the self-cleaning oven* section.

CLEAN Light

Flashes while in edit mode—you can change the length of time for the self-clean cycle at this point. Glows when the oven is in the self-clean cycle. After the self-clean cycle, the light will turn off. Unlatch the door.

13 **OFF Pad**

Touch this pad to cancel **ALL** oven operations except the clock and timer.

14 **BROIL Pad**

Touch this pad to select the broil function.

BROIL Light

Flashes while in edit mode—you can switch from **HI** to **LO BROIL** at this point. Glows when the oven is in broil mode.

Indicator Lights (on some pads)

EDIT mode lasts several seconds after the last pad press. **START TIME** and **COOK TIME** will be the only pads lit if either of these options is selected. (Example: **START TIME** is selected with **BAKE**—the **START TIME** pad will remain lit until the clock reaches the programmed time, at which point it will turn off and the **BAKE** pad light will light up).

Temperature Conversions

Fahrenheit°	140	150	170	200	250	275	300	325	350	375	400	425	450	475	500	525	550
Celsius°	60	65	75	95	120	135	150	160	175	190	205	220	230	245	260	275	290

Power Outage

If a flashing time is in the display, you have experienced a power failure. Reset the clock.

To reset the clock, touch the **CLOCK** pad. Enter the correct time of day by touching the **+** or **-** pads. Touch the **START/ON** pad.

Using the oven.

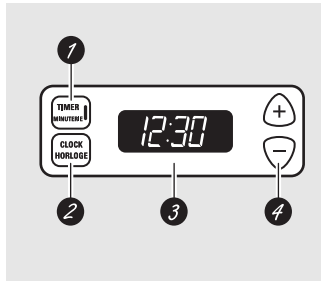

Appearance may vary.

Clock and Timer (on some models)

- 1** **TIMER Pad**
Touch this pad to select the timer feature.
- 2** **CLOCK Pad**
Touch this pad before setting the clock.
- 3** **Display**
Shows the time of day and the time set for the timer, cook time or start time.
- 4** **SET +/- Pads**
These pads allow you to set the clock and timer.

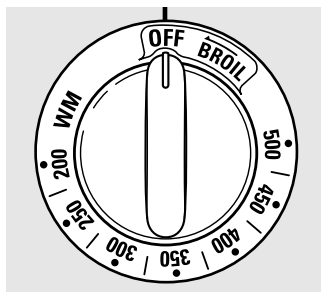

Oven Temperature Knob (on some models)

Turn this knob to the setting you want.

- The oven cycling light glows until the oven reaches your selected temperature, then goes off and on with the oven element(s) during cooking.

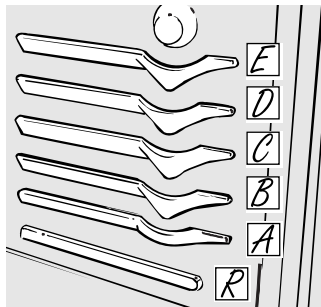

The oven has 5 shelf positions. It also has a special low shelf position (R) for extra large items, such as a large turkey.

Before you begin...

To avoid possible burns, place the shelves in the desired position before you turn the oven on.

The shelves have stop-locks, so that when placed correctly on the shelf supports (A through E), they will stop before coming completely out, and will not tilt.

When placing and removing cookware, pull the shelf out to the bump on the shelf support.

To remove a shelf, pull it toward you, tilt the front end up and pull it out.

To replace, place the end of the shelf (stop-locks) on the support, tilt up the front and push the shelf in.

NOTE: The shelf is not designed to slide out at the special low shelf (R) position.

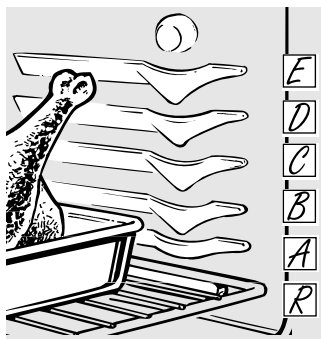

The oven has a special low shelf (R) position just above the oven bottom. Use it when extra cooking space is needed, for example, when cooking a large turkey. The shelf is not designed to slide out at this position.

How to Set the Oven for Baking or Roasting (on models without an oven temperature knob)

- 1** Touch the **BAKE** pad.
- 2** Touch the **+** or **-** pads until the desired temperature is displayed.
- 3** Touch the **START/ON** pad.
- 4** Check food for doneness at minimum time on recipe. Cook longer if necessary.
- 5** Touch the **OFF** pad when baking is finished and then remove the food from the oven.

The oven will start automatically. The display will show **PRE** while preheating. When the oven reaches the selected temperature, the oven control will beep and the display will show the oven temperature.

To change the oven temperature during **BAKE** cycle, touch the **BAKE** pad and then the **+** or **-** pads to get the new temperature.

Type of Food	Shelf Position
Frozen pies (on cookie sheet)	C
Angel food cake, bundt or pound cakes	B
Biscuits, muffins, brownies, cookies, cupcakes, layer cakes, pies	B or C
Casseroles	B or C
Turkey	R or A
Roasting	R, A or B

Preheating and Pan Placement

Preheat the oven if the recipe calls for it. To preheat, set the oven at the correct temperature. Preheating is necessary for good results when baking cakes, cookies, pastry and breads.

For ovens without a preheat indicator light or tone, preheat 10 minutes.

On some models, the display will show "PRE" while preheating. When the oven reaches the selected temperature, the oven control will beep and the display will show the oven temperature.

Baking results will be better if baking pans are centered in the oven as much as possible. Pans should not touch each other or the walls of the oven. If you need to use two shelves, stagger the pans so one is not directly above the other, and leave approximately 1½" from the front of the pan to the front of the shelf.

Aluminum Foil

Do not use aluminum foil on the bottom of the oven.

Never entirely cover a shelf with aluminum foil. This will disturb the heat circulation and result in poor baking.

A smaller sheet of foil may be used to catch a spillover by placing it on a lower shelf several inches below the food.

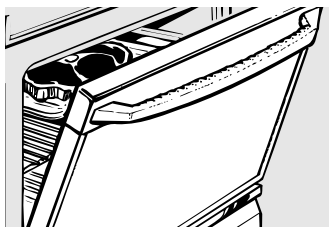

Leave the door open to the broil stop position. The door stays open by itself, yet the proper temperature is maintained in the oven.

How to Set the Oven for Broiling *(on models without an oven temperature knob)*

- 1 Place the meat or fish on a broiler grid in a broiler pan.
- 2 Follow suggested shelf positions in the *Broiling Guide*.
- 3 Touch the **BROIL** pad once for HI Broil.
- 4 Touch the **START/ON** pad.
- 5 When broiling is finished, touch the **OFF** pad.

If your range is connected to 208 volts, rare steaks may be broiled by preheating the broiler and positioning the oven shelf one position higher.

Use **LO Broil** to cook foods such as poultry or thick cuts of meat thoroughly without over-browning them.

- 3 Touch the **BROIL** pad once for HI Broil.

To change to LO Broil, touch the **BROIL** pad again.

Using the oven.

The size, weight, thickness, starting temperature and your preference of doneness will affect broiling times. This guide is based on meats at refrigerator temperature.

† The U.S. Department of Agriculture says "Rare beef is popular, but you should know that cooking it to only 140°F. means some food poisoning organisms may survive." (Source: *Safe Food Book. Your Kitchen Guide.* USDA Rev. June 1985.)

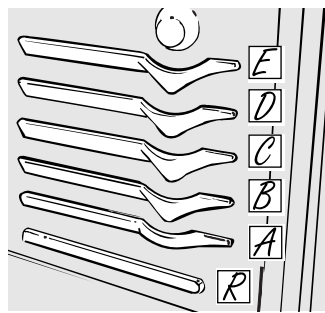

The oven has 5 shelf positions.

Broiling Guide

Food	Quantity and/or Thickness	Shelf* Position	First Side Time (min.)	Second Side Time (min.)	Comments
Ground Beef	1 lb. (4 patties) ½ to ¾" thick	C	10	7-10	Space evenly.
	4 lbs. (12 patties)	C	15	11	
Beef Steaks	Rare† Medium Well Done	E	6	4	Steaks less than ¾" thick are difficult to cook rare. Slash fat.
		D	8	6	
		D	10	7-10	
	Rare† Medium Well Done	C	10	8	
		C	15	10-12	
		D	20	20	
Chicken	1 whole cut up 2 to 2 ½ lbs., split lengthwise Breast	B	25	25	Brush each side with melted butter. Broil skin-side-down first.
		B	25	15	
Bakery Product	Bread (toast) English Muffin	D	3	1	Space evenly. Place English muffins cut-side-up and brush with butter if desired.
		E	3-4		
Lobster Tails	2-4	B	18-20	Do not turn over.	Cut through back of shell. Spread open. Brush with melted butter before broiling and after half of broiling time.
Fish Fillets	1 lb. (¼ to ½" thick)	D	5	5	Handle and turn very carefully. Brush with lemon butter before and during cooking, if desired.
Salmon	Steaks Fillets	D	10	5	Turn carefully. Do not turn skin side down.
		D	10		
Ham Slices (precooked)	½" thick 1" thick	C	6	6	
		C	8	8	
Pork Chops	2 (½" thick) Well Done 2 (1" thick) about 1 lb.	C	10	10	Slash fat.
		C	15	15	
Lamb Chops	Medium Well Done	D	7	4	Slash fat.
		D	10	9	
	Medium Well Done	D	9	6	
		D	14	10	

*See illustration for description of shelf positions.

Using the clock, timer and convenience outlet. *(on some models)*

Not all features are on all models.

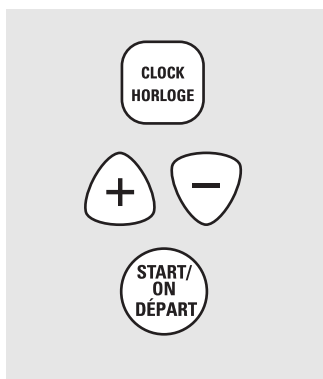

Make sure the clock is set to the correct time of day.

To Set the Clock

The clock must be set to the correct time of day for the automatic oven timing functions to work properly. The time of day cannot be changed during a timed baking or self-cleaning cycle.

- 1 Touch the **CLOCK** pad twice.
- 2 Touch the **+** or **-** pads.

If the **+** or **-** pads are not touched within one minute after you touch the **CLOCK** pad, the display reverts to the original setting. If this happens, touch the **CLOCK** pad and reenter the time of day.

- 3 Touch the **START/ON** pad until the time of day shows in the display. This enters the time and starts the clock.

To check the time of day when the display is showing other information, simply touch the **CLOCK** pad. The time of day shows until another pad is touched.

To Turn Off the Clock Display

If you have several clocks in your kitchen, you may wish to turn off the time of day clock display on your range.

- 1 Touch the **CLOCK** pad once to turn off the time of day display. Although you will not be able to see it, the clock maintains the correct time of day.

- 2 Touch the **CLOCK** pad again to recall the clock display.

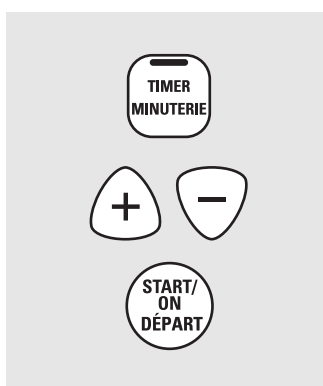

The timer is a minute timer only. The **OFF** pad does not affect the timer.

To Set the Timer

The timer does not control oven operations. The maximum setting on the timer is 9 hours and 59 minutes.

- 1 Touch the **TIMER** pad.
- 2 Touch the **+** or **-** pads until the amount of time you want shows in the display. The maximum time that can be entered in minutes is 59. Times more than 59 minutes should be changed to hours and minutes.

If you make a mistake, touch the **TIMER** pad and begin again.

- 3 Touch the **START/ON** pad. The time will start counting down, although the display does not change until one minute has passed.
- 4 When the timer reaches **:00**, the control will beep 3 times followed by one beep every 6 seconds until the **TIMER** pad is touched.

Using the clock, timer and convenience outlet. *(on some models)*

Not all features are on all models.

To Reset the Timer

If the display is still showing the time remaining, you may change it by touching the **TIMER** pad, then touch the **+** or **-** pads until the time you want appears in the display.

If the remaining time is not in the display (clock, delay start or cooking time are in the display), recall the remaining time by touching the **TIMER** pad and then touching the **+** or **-** pads to enter the new time you want.

To Cancel the Timer

Touch the **TIMER** pad twice.

End of Cycle Tones *(on some models)*

Clear the tones by pressing the pad of the function you are using.

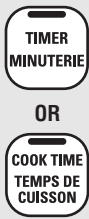

Power Outage

If a flashing time is in the display, you have experienced a power failure. Reset the clock.

To reset the clock, touch the **CLOCK** pad twice. Enter the correct time of day by touching the **+** or **-** pads. Touch the **START/ON** pad.

Convenience Outlet *(on some models)*

The 120V convenience outlet located on the top of the backguard may be used to plug in small electrical appliances.

When using the outlet, be sure that the electrical cord does not rest on or near a surface unit. If the surface unit is turned on, the cord will be damaged.

To reset the circuit breaker, press the switch located near the outlet on top of the backguard.

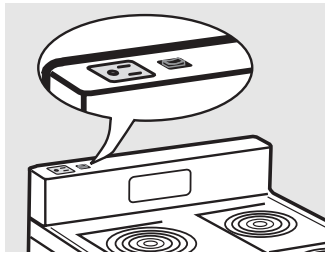

Using the timed baking and roasting features. *(on some models)*

Do not lock the oven door with the latch during timed cooking. The latch is used for self-cleaning only.

NOTE: Foods that spoil easily—such as milk, eggs, fish, stuffings, poultry and pork—should not be allowed to sit for more than 1 hour before or after cooking. Room temperature promotes the growth of harmful bacteria. Be sure that the oven light is off because heat from the bulb will speed harmful bacteria growth.

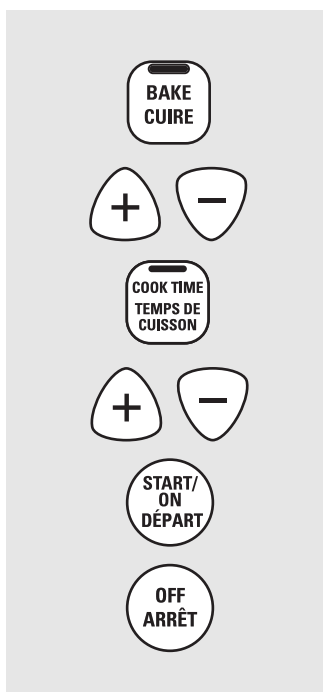

How to Set an Immediate Start and Automatic Stop

The oven will turn on immediately and cook for a selected length of time. At the end of the cooking time, the oven will turn off automatically.

- 1 Touch the **BAKE** pad.
- 2 Touch the **+** or **-** pads to set the oven temperature.
- 3 Touch the **COOK TIME** pad.

NOTE: If your recipe requires preheating, you may need to add additional time to the length of the cooking time.

- 4 Touch the **+** or **-** pads to set the baking time.

The cooking time that you entered will be displayed. (If you select Cooking Time first and then adjust the Bake Temperature, the oven temperature will be displayed instead).

- 5 Touch the **START/ON** pad.

The display shows either the oven temperature that you set or the cooking time countdown. (The display starts with **PRE** if showing the oven temperature.)

The oven will continue to cook for the programmed amount of time, then turn off automatically.

- 6 Touch the **OFF** pad to clear the display if necessary.

Remove the food from the oven. Remember, even though the oven shuts off automatically, foods continue cooking after controls are off.

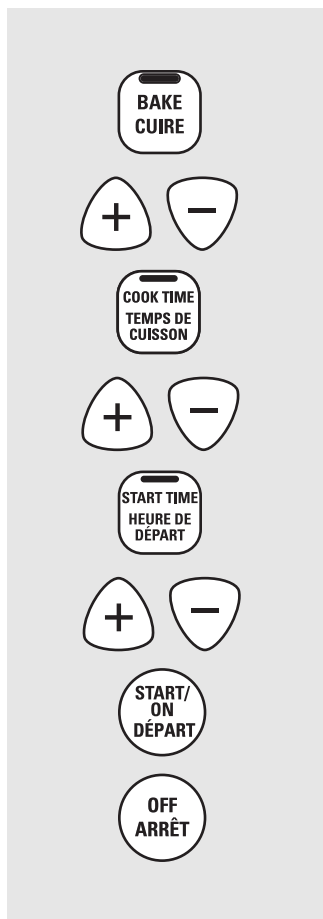

How to Set a Delayed Start and Automatic Stop

The oven will turn on at the time of day you set, cook for a specific length of time and then turn off automatically.

Make sure the clock shows the correct time of day.

- 1 Touch the **BAKE** pad.
- 2 Touch the **+** or **-** pads to set the oven temperature.
- 3 Touch the **COOK TIME** pad.
- 4 Touch the **+** or **-** pads to set the desired length of cooking time.
- 5 Touch the **START TIME** pad.
- 6 Touch the **+** or **-** pads to set the time of day you want the oven to turn on and start cooking.
- 7 Touch the **START/ON** pad.

NOTE: An attention tone will sound if you are using timed baking and do not touch the **START/ON** pad.

NOTE: If you would like to check the times you have set, touch the **START TIME** pad to check the start time you have set or touch the **COOK TIME** pad to check the length of cooking time you have set.

When the oven turns on at the time of day you have set, the display will show **PRE** until it reaches the selected temperature, then it will display the oven temperature.

At the end of cooking time, the oven will turn off and the end of cycle tone will sound.

- 8 Touch the **OFF** pad to clear the display if necessary.

Remove the food from the oven. Remember, even though the oven shuts off automatically, foods continue cooking after controls are off.

Special features of your oven control.

Your new touch pad control has additional features that you may choose to use. The following are the features and how you may activate them.

The special feature modes can only be activated while the display is showing the time of day. They remain in the control's memory until the steps are repeated.

When the display shows your choice, touch the **START/ON** pad. The special features will remain in memory after a power failure.

NOTE: The Sabbath feature and the Thermostat Adjustment feature are also Special Features, but they are addressed separately in the following sections.

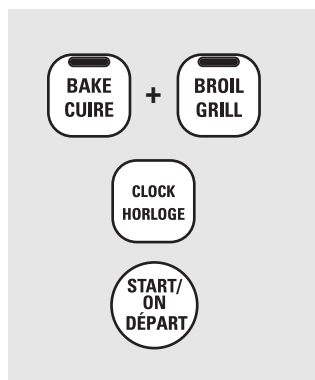

12 Hour Shut-Off

With this feature, should you forget and leave the oven on, the control will automatically turn off the oven after 12 hours during baking functions or after 3 hours during a broil function.

If you wish to turn **OFF** this feature, follow the steps below.

1 Touch the **BAKE** and **BROIL** pads at the same time for 3 seconds until the display shows **SF**.

2 Touch the **CLOCK** pad. The display will show **ON** (12 hour shut-off). Touch the **CLOCK** pad repeatedly until the display shows **OFF** (no shut-off).

3 Touch the **START/ON** pad to activate the no shut-off and leave the control set in this special features mode.

Using the Sabbath Feature. (on some models)

(Designed for use on the Jewish Sabbath and Holidays)

The Sabbath feature can be used for baking/roasting only. It cannot be used for broiling, self-cleaning or Delay Start cooking.

NOTE: The oven light comes on automatically (on some models) when the door is opened and goes off when the door is closed. The bulb may be removed. See the Oven Light Replacement section. On models with a light switch on the control panel, the oven light may be turned on and left on.



When the display shows \supset the oven is set in Sabbath. When the display shows $\supset \subset$ the oven is baking/roasting.

How to Set for Regular Baking/Roasting

NOTE: To understand how the oven control works, practice using regular baking (non-Sabbath) before entering Sabbath mode.

Make sure the clock shows the correct time of day and the oven is off.

- 1 Touch and hold **both** the **BAKE** and **BROIL** pads, **at the same time**, until the display shows **SF**.
- 2 Tap the **CLOCK** pad until **SAb** appears in the display.
- 3 Touch the **START/ON** pad and \supset will appear in the display.
- 4 Touch the **BAKE** pad. No signal will be given.
- 5 The preset starting temperature will automatically be set to 350°. Tap the **+** or **-** pads to increase or decrease the temperature in 25° increments. The temperature can be set between 170° and 550°. No signal or temperature will be given.

- 6 Touch the **START/ON** pad.
- 7 After a random delay period of approximately 30 seconds to 1 minute, $\supset \subset$ will appear in the display indicating that the oven is baking/roasting. If $\supset \subset$ doesn't appear in the display, start again at Step 4.

To adjust the oven temperature, touch the **BAKE** pad and tap the **+** or **-** pads to increase or decrease the temperature in 25° increments. Touch the **START/ON** pad.

NOTE: The **OFF** and **COOK TIME** pads are active during the Sabbath feature.

How to Set for Timed Baking/Roasting—Immediate Start and Automatic Stop

NOTE: To understand how the oven control works, practice using regular (non-Sabbath) Immediate Start and Automatic Stop before entering the Sabbath mode.

Make sure the clock shows the correct time of day and the oven is off.

- 1 Touch and hold **both** the **BAKE** and **BROIL** pads, **at the same time**, until the display shows **SF**.
- 2 Tap the **CLOCK** pad until **SAb** appears in the display.
- 3 Touch the **START/ON** pad and \supset will appear in the display.
- 4 Touch the **COOK TIME** pad.
- 5 Touch the **+** or **-** pads to set the desired length of cooking time between 1 minute and 9 hours and 59 minutes. The cooking time that you entered will be displayed.
- 6 Touch the **START/ON** pad.
- 7 Touch the **BAKE** pad. No signal will be given.

- 8 The preset starting temperature will automatically be set to 350°. Tap the **+** or **-** pads to increase or decrease the temperature in 25° increments. The temperature can be set between 170° and 550°. No signal or temperature will be given.

- 9 Touch the **START/ON** pad.
- 10 After a random delay period of approximately 30 seconds to 1 minute, $\supset \subset$ will appear in the display indicating that the oven is baking/roasting. If $\supset \subset$ doesn't appear in the display, start again at Step 7.

To adjust the oven temperature, touch the **BAKE** pad and tap the **+** or **-** pads to increase or decrease the temperature in 25° increments. Touch the **START/ON** pad.

When cooking is finished, the display will change from $\supset \subset$ to \supset , indicating that the oven has turned **OFF** but is still set in Sabbath. Remove the cooked food.

When the display shows \supset the oven is set in Sabbath. When the display shows $\supset \subset$ the oven is baking/roasting.

Using the Sabbath Feature. (on some models)

(Designed for use on the Jewish Sabbath and Holidays)

How to Exit the Sabbath Feature

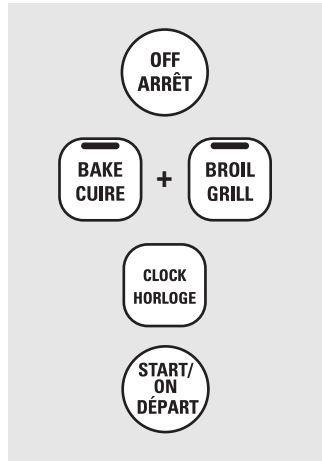

- 1 Touch the **OFF** pad.
- 2 If the oven is cooking, wait for a random delay period of approximately 30 seconds to 1 minute, until only \supset is in the display.
- 3 Touch and hold **both** the **BAKE** and **BROIL** pads, **at the same time**, until the display shows **SF**.

- 4 Tap the **CLOCK** pad until **ON** or **OFF** appears in the display. **ON** indicates that the oven will automatically turn off after 12 hours. **OFF** indicates that the oven will not automatically turn off. See the *Special Features* section for an explanation of the *12 Hour Shut-Off* feature.

- 5 Touch the **START/ON** pad.

NOTE: If a power outage occurred while the oven was in Sabbath, the oven will automatically turn off and stay off even when the power returns. The oven control must be reset.

Adjust the oven thermostat—Easy to do yourself!

You may find that your new oven cooks differently than the one it replaced. Use your new oven for a few weeks to become more familiar with it. If you still think your new oven is too hot or too cold, you can adjust the thermostat yourself.

Do not use thermometers, such as those found in grocery stores, to check the temperature setting of your oven. These thermometers may vary 20–40°F.

NOTE: This adjustment will not affect the broiling or the self-cleaning temperatures (on some models). The adjustment will be retained in memory after a power failure.

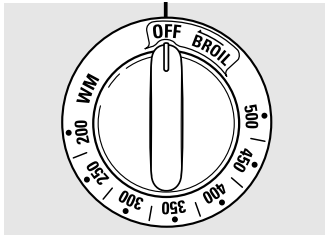

Front of OVEN TEMP knob
(knob appearance may vary)

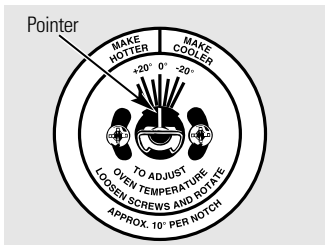

Back of OVEN TEMP knob

To Adjust the Thermostat with this Type of Knob

- 1 Pull the Oven Temp knob off the shaft, look at the back of the knob and note the current setting **before** making any adjustments.
- 2 Loosen both screws on the back of the knob.
- 3 To **increase** the oven temperature, move the pointer toward the words **"MAKE HOTTER."**
- 4 Tighten the screws.
- 5 Replace the knob, matching the flat area of the knob to the shaft.

To **decrease** the oven temperature, turn the pointer toward the words **"MAKE COOLER."**

Each notch changes the temperature by 10°F.

To Adjust the Thermostat on Other Models

- 1 Touch the **BAKE** and **BROIL** pads at the same time for 2 seconds until the display shows **SF**.
- 2 Touch the **BAKE** pad. A two digit number shows in the display.
- 3 The oven temperature can be adjusted up to (+) 35°F hotter or (-) 35°F cooler. Touch the **+** pad to increase the temperature in 1 degree increments. Touch the **-** pad to decrease the temperature in 1 degree increments.
- 4 When you have made the adjustment, touch the **START/ON** pad to go back to the time of day display. Use your oven as you would normally.

NOTE: This adjustment will not affect the broiling or self-cleaning temperatures. It will be retained in memory after a power failure.

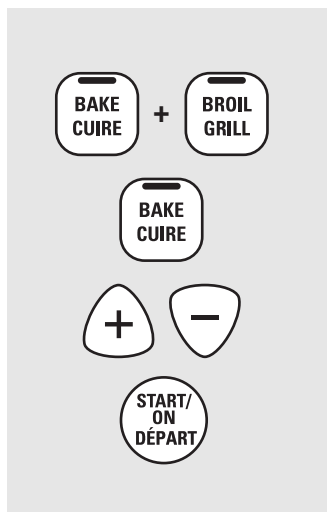

The type of margarine will affect baking performance!

Most recipes for baking have been developed using high fat products such as butter or margarine (80% fat). If you decrease the fat, the recipe may not give the same results as with a higher fat product.

Recipe failure can result if cakes, pies, pastries, cookies or candies are made with low fat spreads. The lower the fat content of a spread product, the more noticeable these differences become.

Federal standards require products labeled "margarine" to contain at least 80% fat by weight. Low-fat spreads, on the other hand, contain less fat and more water. The high moisture content of these spreads affects the texture and flavor of baked goods. For best results with your old favorite recipes, use margarine, butter or stick spreads containing at least 70% vegetable oil.

Using the self-cleaning oven. (on some models)

Never force the latch handle. Forcing the handle will damage the door lock mechanism.

The oven door must be closed and all controls set correctly for the cycle to work properly.

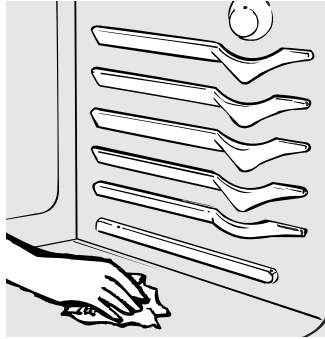

Wipe up heavy soil on the oven bottom.

Before a Clean Cycle

For the first self-clean cycle, we recommend venting your kitchen with an open window or using a ventilation fan or hood.

Remove the shelves, any broiler pan, broiler grid, all cookware and any aluminum foil from the oven.

The oven shelves can be self-cleaned, but they will darken, lose their luster and become hard to slide.

Soil on the front frame of the range and outside the gasket on the door will need to be cleaned by hand. Clean these areas with hot water, soap-filled steel-wool pads or cleansers such as Soft Scrub®. Rinse well with clean water and dry.

Do not clean the gasket. The fiberglass material of the oven door gasket cannot withstand abrasion. It is essential for the gasket to remain intact. If you notice it becoming worn or frayed, replace it.

Wipe up any heavy spillovers on the oven bottom.

Make sure the oven light bulb cover is in place and the oven light is off.

CAUTION: The grates and drip pans (on some models) should never be cleaned in the self-cleaning oven.

Do not use commercial oven cleaners or oven protectors in or near the self-cleaning oven. A combination of any of these products plus the high clean cycle temperatures may damage the porcelain finish of the oven.

IMPORTANT: The health of some birds is extremely sensitive to the fumes given off during the self-cleaning cycle of any range. Move birds to another well ventilated room.

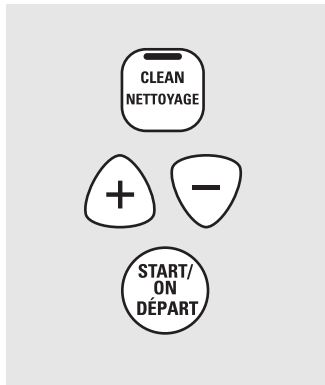

How to Set the Oven for Cleaning

Follow the directions in the *Before a Clean Cycle* section.

1 Latch the door.

NOTE: Never force the latch. If the oven is too hot, you will not be able to slide the latch. Allow the oven to cool.

2 Touch the **CLEAN** pad.

3 Touch the **+** or **-** pads until the desired Clean Time is displayed.

The Clean Time is normally 4 hours and 20 minutes. You can change the Clean Time to any time between 3 and 5 hours, depending on the amount of soil in your oven.

4 Touch the **START/ON** pad.

The self-clean cycle will automatically begin after **CLEAN** is displayed and the time countdown appears in the display.

While the oven is self-cleaning, you can touch the **CLOCK** pad to display the time of day. To return to the clean countdown, touch the **CLEAN** pad.

The oven shuts off automatically when the clean cycle is complete, and 0:00 will flash in the display.

5 Slide the latch handle to the left as far as it will go and open the door.

The oven door must be closed and all controls set correctly for the cycle to work properly.

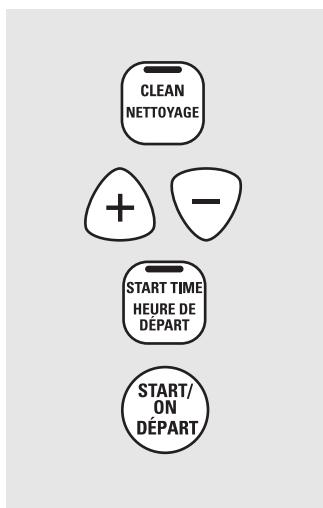

How to Delay the Start of Cleaning

You can set the oven control to delay-start the oven, clean for a specific length of time and then turn off automatically.

Make sure the clock shows the correct time of day.

Follow the directions in the *Before a Clean Cycle* section.

1 Latch the door.

NOTE: Never force the latch. If the oven is too hot, you will not be able to slide the latch. Allow the oven to cool.

2 Touch the **CLEAN** pad.

3 Touch the **+** or **-** pads to set the Clean Time.

The Clean Time is preset for 4 hours and 20 minutes. You can change the Clean Time to any time between 3 and 5 hours, depending on the amount of soil in your oven. If a different Clean Time is desired, touch the **+** or **-** pads until the desired Clean Time is displayed.

4 Touch the **START TIME** pad.

Change the Start Time by touching the **+** or **-** pads. The start time will appear in the display.

5 Touch the **START/ON** pad.

The self-clean cycle will automatically begin at the time set.

While the oven is self-cleaning, you can touch the **CLOCK** pad to display the time of day. To return to the clean countdown, touch the **CLEAN** pad.

The oven shuts off automatically when the clean cycle is complete, and 0:00 will flash in the display.

6 Slide the latch handle to the left as far as it will go and open the door.

To Stop a Clean Cycle

Touch the **OFF** pad.

Wait until the oven has cooled below the locking temperature to unlatch the door. You will not be able to open the door right away unless the oven has cooled below the locking temperature.

After a Clean Cycle

You may notice some white ash in the oven. Wipe it up with a damp cloth after the oven cools.

If white spots remain, remove them with a soap-filled steel-wool pad and rinse thoroughly with a vinegar and water mixture.

These deposits are usually a salt residue that cannot be removed by the clean cycle.

If the oven is not clean after one clean cycle, repeat the cycle.

■ You cannot set the oven for cooking until the oven is cool enough for the door to unlock.

■ While the oven is self-cleaning, you can touch the **CLOCK** pad to display the time of day. To return to the clean countdown, touch the **COOK TIME** pad.

■ If the shelves become hard to slide, apply a small amount of vegetable oil or cooking oil to a paper towel and wipe the edges of the oven shelves with the paper towel.

Care and cleaning of the range.

Be sure electrical power is off and all surfaces are cool before cleaning any part of the range.

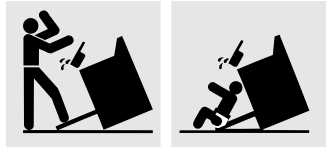

If your range is removed for cleaning, servicing or any reason, be sure the anti-tip device is re-engaged properly

when the range is replaced. Failure to take this precaution could result in tipping of the range and cause injury.

Oven Interior (non-self clean models)

With proper care, the porcelain enamel finish on the inside of the oven—top, bottom, sides, back and inside of the door—will stay new-looking for years.

Let the range cool before cleaning. We recommend that you wear rubber gloves when cleaning the range.

Soap and water will normally do the job. Heavy spattering or spillovers may require cleaning with a mild abrasive cleaner. Soap-filled scouring pads may also be used.



Do not allow food spills with a high sugar or acid content (such as milk, tomatoes, sauerkraut, fruit juices or pie filling) to remain on the surface. They may cause a dull spot even after cleaning.

Household ammonia may make the cleaning job easier. Place 1/2 cup in a shallow glass or pottery container in a cold

oven overnight. The ammonia fumes will help loosen the burned-on grease and food.

If necessary, you may use an oven cleaner. Follow the package directions.

Do not spray oven cleaner on the electrical controls and switches because it could cause a short circuit and result in sparking or fire.

Do not allow a film from the cleaner to build up on the temperature sensor—it could cause the oven to heat improperly. (The sensor is located at the top of the oven.) Carefully wipe the sensor clean after each oven cleaning, being careful not to move the sensor as a change in its position could affect how the oven bakes.

Do not spray any oven cleaner on the oven door, handles or any exterior surface of the oven, cabinets or painted surfaces. The cleaner can damage these surfaces.



Lift the door straight up and off the hinges.

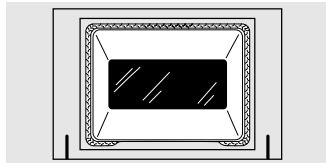

The gasket is designed with a gap at the bottom to allow for proper air circulation.

Because the area inside the gasket is cleaned during the self-clean cycle, you do not need to clean this by hand on self-clean models.

The area outside the gasket and the front frame can be cleaned with a soap-filled steel-wool pad, hot water and detergent. Rinse well with a vinegar and water solution.

Do not rub or clean the door gasket—it has an extremely low resistance to abrasion.

If you notice the gasket becoming worn, frayed or damaged in any way, or if it has become displaced on the door, you should have it replaced.

Lift-Off Oven Door

The oven door is removable for cleaning.

Do not lift the door by the handle. Make sure the oven is completely cool.

To remove the door, open it to the special stop position. Grasp firmly on each side and lift the door straight up and off the hinges.

Do not place hands between the hinge and the oven door frame.

To replace the door, make sure the hinges are in the special stop position. Position the slots in the bottom of the door squarely over the hinges and slowly lower it over both hinges.

To clean the inside of the door:

- Do not allow excess water to run into any holes or slots in the door.
- Soap and water will normally do the job. Heavy spattering or spillovers may require cleaning with a mild abrasive cleaner. Soap-filled, steel-wool pads may also be used.

Do not allow food spills with a high sugar or acid content (such as milk, tomatoes, sauerkraut, fruit juices or pie filling) to remain on the surface. They may cause a dull spot even after cleaning.

To clean the outside of the door:

- Use soap and water to thoroughly clean the top, sides and front of the oven door. Rinse well. You may also use a glass cleaner to clean the glass on the outside of the door. Do not let water drip into the vent openings.
- Spillage of marinades, fruit juices, tomato sauces and basting materials containing acids may cause discoloration and should be wiped up immediately. When surface is cool, clean and rinse.
- Do not use oven cleaners, cleaning powders or harsh abrasives on the outside of the door.

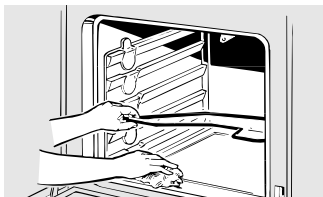

Oven Heating Elements

Do not clean the bake element or the broil element. Any soil will burn off when the elements are heated.

To clean the oven floor, gently lift the bake element. Clean with warm soapy water.



Oven Shelves

Clean the oven shelves with an abrasive cleanser or scouring pad. After cleaning, rinse the shelves with clean water and dry with a clean cloth.

NOTE: Take the shelves out of the oven before you begin the self-clean cycle or they may discolor.

To make the shelves slide more easily, apply a small amount of vegetable oil or cooking oil to a paper towel and wipe the edges of the oven shelves with the paper towel.

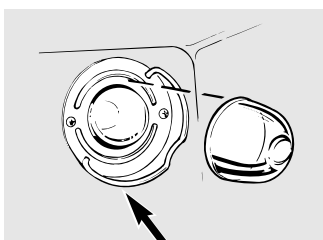

Wire cover holder

Oven Light Replacement *(on some models)*

CAUTION: Before replacing your oven light bulb, turn the oven light off and disconnect the electrical power to the range at the main fuse or circuit breaker panel.

Be sure to let the light cover and bulb cool completely.

To remove the cover:

- 1 Hold a hand under the cover so it doesn't fall when released. With fingers of the same hand, firmly push back the wire cover holder. Lift off the cover.

Do not remove any screws to remove the cover.

- 2 Replace bulb with a 40-watt household appliance bulb.

To replace the cover:

- 1 Place it into groove of the light receptacle. Pull wire forward to the center of the cover until it snaps into place.
- 2 Connect electrical power to the range.

Care and cleaning of the range.

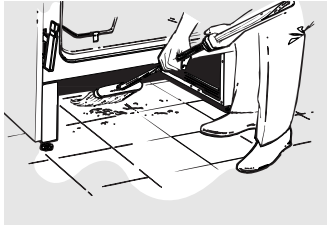

Clean under the range.

Storage Drawer Removal (on some models)

To remove the storage drawer:

- 1 Pull the drawer out all the way.
- 2 Tilt up the front and remove it.

To replace the storage drawer:

- 1 Insert glides at the back of the drawer beyond the stop on range glides.
- 2 Lift the drawer if necessary to insert easily.
- 3 Let the front of the drawer down, then push in to close.

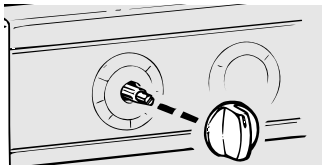

Pull the knob straight off the stem.

Control Panel and Knobs

It's a good idea to wipe the control panel after each use of the oven. Use a damp cloth to clean or rinse. For cleaning, use mild soap and water or a 50/50 solution of vinegar and water. For rinsing, use clean water. Polish dry with a soft cloth.

Do not use abrasive cleansers, strong liquid cleaners, plastic scouring pads or oven cleaners on the control panel—they will damage the finish.

The control knobs may be removed for easier cleaning.

Make sure the knobs are in the **OFF** positions and pull them straight off the stems for cleaning.

The knobs can be cleaned in a dishwasher or they may also be washed with soap and water. Make sure the insides of the knobs are dry before replacing.

Replace the knobs in the **OFF** position to ensure proper placement.

Porcelain Enamel Cooktop (on some models)

The porcelain enamel finish is sturdy but breakable if misused. This finish is acid-resistant. However, any acidic foods spilled (such as fruit juices, tomato or vinegar) should not be permitted to remain on the finish.

If acids spill on the cooktop while it is hot, use a dry paper towel or cloth to wipe it up right away. When the surface has cooled, wash with soap and water. Rinse well.

For other spills such as fat splatterings, wash with soap and water or cleansing powders after the surface has cooled. Rinse well. Polish with a dry cloth.

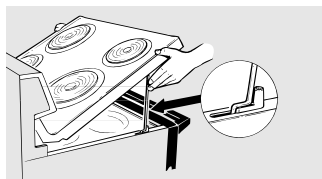

Be sure all surface units are turned off before raising the cooktop.

Lift-Up Cooktop (on some models)

Some models have a cooktop that can be lifted up for easier cleaning. The entire cooktop may be lifted up and supported in the up position.

The surface units do not need to be removed; however, you may remove one to make raising the cooktop easier. There are two side supports that lock into position when the cooktop is lifted up.

After cleaning under the cooktop with hot, mild soapy water and a clean cloth, lower the cooktop. Be careful not to pinch your fingers.

To lower the cooktop, push the rods back and gently lower the cooktop until it rests in place.

NOTE: Do not lift the cooktop on radiant top models. Lifting the cooktop can lead to damage and improper operation of the range.

Surface unit

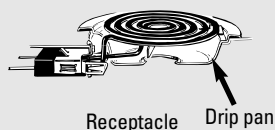
**Surface Units** (on some models)

Be sure all the controls are turned to OFF and the surface units are cool before attempting to remove them.

To clean the surface units, turn the control to the highest setting for a minute. The coils will burn off any soil.

To remove a surface unit:

To remove the drip pans for cleaning, the surface units must be removed first.

Lift the surface unit about 1 inch above the drip pan and pull it out.

Do not lift the surface unit more than 1". If you do, it may not lie flat on the drip pan when you plug it back in.

Repeated lifting of the surface unit more than 1 inch above the drip pan can permanently damage the receptacle.

To replace a surface unit:

Replace the drip pan into the recess in the cooktop. Make sure the opening in the pan lines up with the receptacle.

Insert the terminals of the surface unit through the opening in the drip pan and into the receptacle.

Guide the surface unit into place so it rests evenly.



Do not immerse the surface units in liquids of any kind.

Do not clean the surface units in a dishwasher.

Do not bend the surface unit plug terminals.

Do not attempt to clean, adjust or in any way repair the plug-in receptacle.

Drip Pans (if included)

Remove the surface units. Then lift out the drip pans.

Place them in a covered container. Add 1/4 cup ammonia and let soak several hours or overnight. Wash, rinse well and dry.

The drip pans may also be cleaned in the dishwasher.

Clean the area under the drip pans often. Built-up soil, especially grease, may catch fire.

Do not cover the drip pans with foil. Using foil so close to the receptacle could cause shock, fire or damage to the range.

NOTE: Do not clean the drip pans in a self-cleaning oven.

Care and cleaning of the range.

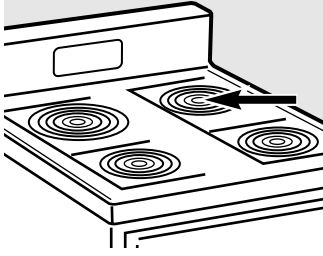

Oven Vent

On glass cooktop models, the oven is vented through an opening at the rear of the cooktop.

On coil cooktop models, the oven is vented through an opening under the right rear surface unit.

Never cover the opening with aluminum foil or any other material.

Painted Surfaces *(on some models)*

Painted surfaces include the sides of the range and the sides of the door trim.

To clean the painted surfaces, use a hot, damp cloth with a mild detergent suitable for these surfaces. Use a clean, hot, damp cloth to remove soap. Dry with a dry, clean cloth.

Do not use steel-wood pads, commercial oven cleaners, cleaning powders or other abrasive cleaners. They will damage the surface.

Stainless Steel Surfaces *(on some models)*

Do not use a steel wool pad; it will scratch the surface.

To clean the stainless steel surface, use warm sudsy water or a stainless steel cleaner or polish. Always wipe the surface in the direction of the grain. Follow the cleaner instructions for cleaning the stainless steel surface.

To inquire about purchasing stainless steel appliance cleaner or polish, or to find the location of a dealer or Mabe Parts Store nearest you, please call our toll-free number:

National Parts Centre **1.800.661.1616**
www.moffatappliances.ca

Glass Window *(on some models)*

To clean the outside glass finish, use a glass cleaner. Rinse and polish with a dry cloth.

Cleaning the glass cooktop. (on some models)

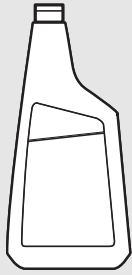

Clean your cooktop after each spill. Use Ceramic Cooktop Cleaner.

Normal Daily Use Cleaning

ONLY use Ceramic Cooktop Cleaner on the glass cooktop. Other types of cleaners may not be as effective.

To maintain and protect the surface of your glass cooktop, follow these steps:

- 1 Before using the cooktop for the first time, clean it with Ceramic Cooktop Cleaner. This helps protect the top and makes cleanup easier.
- 2 Daily use of Ceramic Cooktop Cleaner will help keep the cooktop looking new.

- 3 Shake the cleaning cream well. Apply a few drops of Ceramic Cooktop Cleaner directly to the cooktop.
- 4 Use a paper towel for Ceramic Cooktops to clean the entire cooktop surface.
- 5 Use a dry cloth or paper towel to remove all cleaning residue. No need to rinse.

NOTE: It is very important that you **DO NOT** heat the cooktop until it has been cleaned thoroughly.

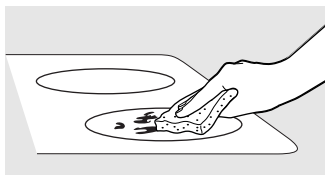

Use a Cleaning Pad for Ceramic Cooktops.

Burned-On Residue

WARNING: DAMAGE to your glass surface may occur if you use scrub pads other than those recommended.

- 1 Allow the cooktop to cool.
- 2 Spread a few drops of Ceramic Cooktop Cleaner on the entire burned residue area.
- 3 Using the included Cleaning Pad for Ceramic Cooktops, rub the residue area, applying pressure as needed.

- 4 If any residue remains, repeat the steps listed above as needed.
- 5 For additional protection, after all residue has been removed, polish the entire surface with Ceramic Cooktop Cleaner and a paper towel.



The Ceramic Cooktop Scraper and all recommended supplies are available through our dealers or through a Mabe Parts Store.

NOTE: Do not use a dull or nicked blade.

Heavy, Burned-On Residue

- 1 Allow the cooktop to cool.
- 2 Use a single-edge razor blade scraper at approximately a 45° angle against the glass surface and scrape the soil. It will be necessary to apply pressure to the razor scraper in order to remove the residue.

- 3 After scraping with the razor scraper, spread a few drops of Ceramic Cooktop Cleaner on the entire burned residue area. Use the Cleaning Pad to remove any remaining residue.
- 4 For additional protection, after all residue has been removed, polish the entire surface with Ceramic Cooktop Cleaner and a paper towel.

Cleaning the glass cooktop. *(on some models)*

Metal Marks and Scratches

1 Be careful not to slide pots and pans across your cooktop. It will leave metal markings on the cooktop surface.

These marks are removable using the Ceramic Cooktop Cleaner with the Cleaning Pad for Ceramic Cooktops.

2 If pots with a thin overlay of aluminum or copper are allowed to boil dry, the overlay may leave black discoloration on the cooktop.

This should be removed immediately before heating again or the discoloration may be permanent.

WARNING: Carefully check the bottom of pans for roughness that would scratch the cooktop.

Cooktop Seal

To clean the cooktop seal around the edges of the glass, lay a wet cloth on it for a few minutes, then wipe clean with nonabrasive cleaners.

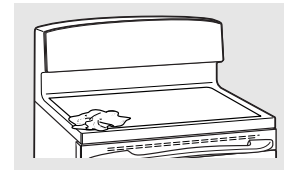

Glass surface—potential for permanent damage.

Sugary spillovers (such as jellies, fudge, candy, syrups) or melted plastics can cause pitting of the surface of your cooktop (not covered by the warranty) unless the spill is removed while still hot. Special care should be taken when removing hot substances.

Be sure to use a new, sharp razor scraper.

Do not use a dull or nicked blade.

Damage from Sugary Spills and Melted Plastic

1 Turn off all surface units. Remove hot pans.

2 Wearing an oven mitt:

- a. Use a single-edge razor blade scraper to move the spill to a cool area on the cooktop.
- b. Remove the spill with paper towels.

3 Any remaining spillover should be left until the surface of the cooktop has cooled.

4 Don't use the surface units again until all of the residue has been completely removed.

NOTE: If pitting or indentation in the glass surface has already occurred, the cooktop glass will have to be replaced. In this case, service will be necessary.

To Order Parts

To inquire about purchasing a part or an accessory for your appliance, please call our toll-free number:

National Parts Centre **1.800.661.1616**

Ceramic Cooktop Cleaner . . . # WX10X300

Ceramic Cooktop Scraper . . . # WX10X302

Kit # WB64X5027
(Kit includes cream and cooktop scraper)

Cleaning Pads for Ceramic Cooktops # WX10X350

Installation Instructions

Free-Standing Electric Ranges

? Questions? Call 1.800.361.3400

BEFORE YOU BEGIN

Read these instructions completely and carefully.

- **IMPORTANT** — Observe all governing codes and ordinances.
- **Note to Installer** – Be sure to leave these instructions with the Consumer.
- **Note to Consumer** – Keep these instructions for future reference.
- **Skill level** – Installation of this appliance requires basic mechanical skills.
- Product failure due to improper installation is not covered under the Warranty.

▲ WARNING — This appliance must be properly connected by means of the supplied cord and plug. If your kitchen does not have a receptacle, you must have one installed by a licensed electrician.

FOR YOUR SAFETY:

▲ WARNING — Before beginning the installation, switch power off at service panel and lock the service disconnecting means to prevent power from being switched on accidentally. When the service disconnecting means cannot be locked, securely fasten a prominent warning device, such as a tag, to the service panel.

All rough-in and spacing dimensions must be met for safe use of your range. Electricity to the range can be disconnected at the outlet without moving the range if the outlet is in the preferred location (remove lower drawer).

FOR YOUR SAFETY:

To reduce the risk of burns or fire when reaching over hot surface elements, cabinet storage space above the cooktop should be avoided. If cabinet storage space is to be provided above the cooktop, the risk can be reduced by installing a range hood that sticks out at least 5" beyond the front of the cabinets. Cabinets installed above a cooktop must be no deeper than 13".

Make sure the cabinets and wall coverings around the range can withstand the temperatures (up to 200°F.) generated by the range.

ANTI-TIP DEVICE

▲ WARNING — To reduce the risk of tipping, the appliance must be secured by properly installed Anti-Tip bracket packed with this appliance.

If the Anti-Tip device supplied with the range does not fit this application, use the universal Anti-Tip device WB2X7909.



▲ WARNING —

- All ranges can tip
- Injury to persons could result
- Install Anti-Tip bracket packed with range
- See Installation Instructions

If you pull the range out and away from the wall for any reason, make sure the Anti-Tip bracket is engaged when the range is pushed back against the wall.

REMOVE SHIPPING MATERIALS

Remove packaging materials. Failure to remove packaging materials could result in damage to the appliance.

NOTE: Cut the orange shipping ties from the power cord, being careful not to damage the cord.

Installation Instructions

PREPARE TO INSTALL THE RANGE

TOOLS YOU WILL NEED

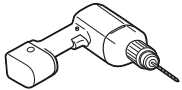

Drill with 1/8" Bit



Safety Glasses



Adjustable Wrench

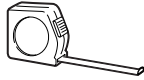

Tape Measure

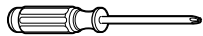

Phillips Screwdriver



Pencil



Flat-blade
Screwdriver



Level

MATERIALS YOU MAY NEED



Lag Bolts



Anchor Sleeves

(For Anti-Tip Bracket Mounted
on Concrete Floors Only)

PARTS INCLUDED

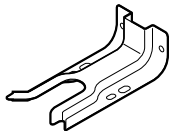

Anti-Tip Bracket Kit

MODEL AND SERIAL NUMBER LOCATION

The rating plate is located behind the storage
drawer on the oven frame.

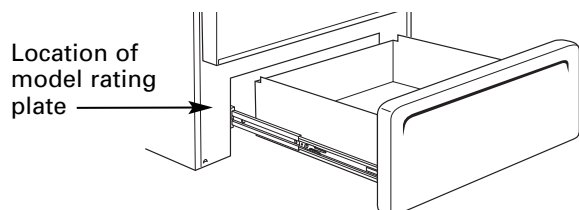

1 PREPARE THE OPENING

Allow 1½" spacing from the range to adjacent
vertical walls above the cooktop surface.

Allow 30" minimum clearance between
the surface units and the bottom of
unprotected wood or metal top cabinet,
and 15" minimum between the
countertop and adjacent cabinet bottom.

**EXCEPTION: Installation of a listed
microwave oven or cooking appliance over
the cooktop shall conform to the installation
instructions packed with that appliance.**

If cabinet storage is installed, reduce the
risk by installing a range hood that projects
horizontally a min. of 5" beyond the
bottom of the cabinets. Make sure the wall
covering, countertops and cabinets around
the range can withstand heat generated
by the range, oven or cooktop up to 200°F.

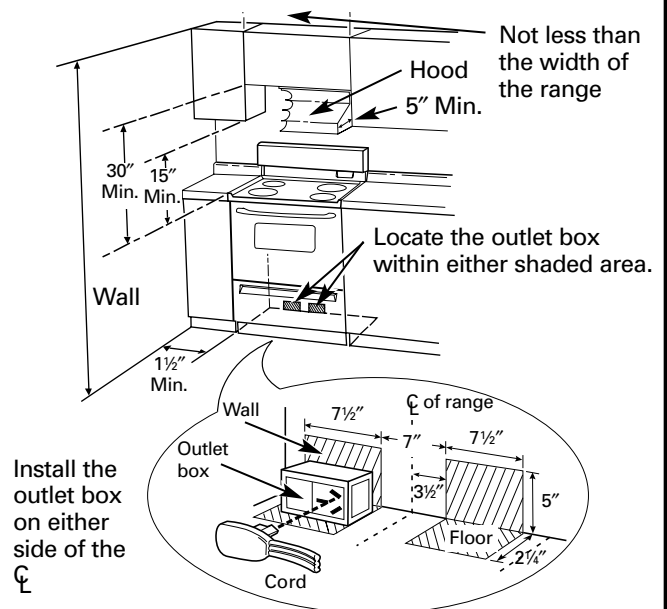

Flooring under the range

**Your range, like many other household items,
is heavy and can settle into soft floor coverings
such as cushioned vinyl or carpeting.**

When moving the range on this type of
flooring, it should be installed on a ¼"
thick sheet of plywood (or similar material)
as follows:

When the floor covering ends at the front
of the range, the area that the range will
rest on should be built up with plywood
to the same level or higher than the floor
covering. This will allow the range to be
moved for cleaning or servicing.

Installation Instructions

INSTALL THE RANGE

2 ANTI-TIP DEVICE INSTALLATION

An **Anti-Tip bracket** is supplied with instructions for installation in a variety of locations. The instructions include all necessary information to complete the installation. Read the **Safety Instructions** and the instructions that fit your situation before beginning installation.

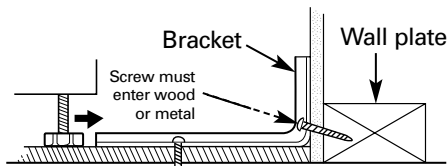

Typical installation of anti-tip bracket attachment to wall

⚠ WARNING:

- Range must be secured by **Anti-Tip bracket** supplied.
- If the Anti-Tip device supplied with the range does not fit this application, use the universal Anti-Tip device WB2X7909.
- See instructions to install (supplied with bracket).
- Unless properly installed, the range could be tipped by stepping or sitting on the door. Injury may result from spilled hot liquids or from the range itself.

3 LEVEL THE RANGE

A Install the oven shelves in the oven and position the range where it will be installed.

B Check for levelness by placing a spirit level or a cup, partially filled with water, on one of the oven shelves. If using a spirit level, take two readings—with the level placed diagonally first in one direction and then the other.

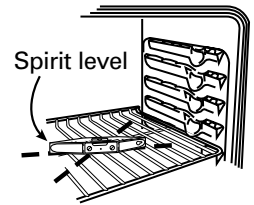

C Remove the storage drawer, broiler drawer or kick panel. The front leveling legs can be adjusted from the bottom and the rear legs can be adjusted from the top.

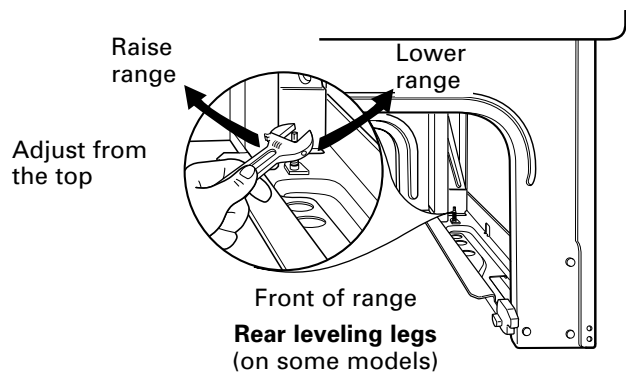
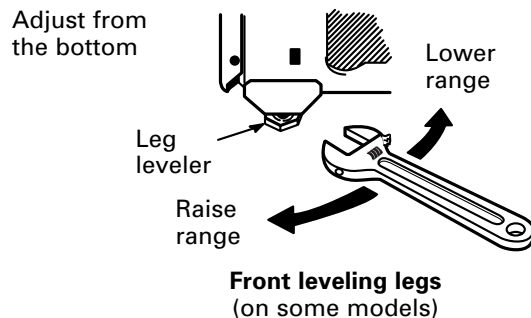

D Use an open-end or adjustable wrench to adjust the leveling legs until the range is level.

E Replace the drawer or panel.

Installation Instructions

4 FINAL INSTALLATION CHECKLIST

- Check to make sure the circuit breaker is closed (RESET) or the circuit fuses are replaced.
- Be sure power is in service to the building.
- **Note (on some models):** If the clock flashes "bAd" and then "LinE" with a loud tone, the neutral connection to the range is miswired. Check the terminal block connections and/or house wiring to correct.
- Check to be sure that all packing materials and tape have been removed. This will include tape on metal panel under control knobs (if applicable), adhesive tape, wire ties, cardboard and protective plastic. Failure to remove these materials could result in damage to the appliance once the appliance has been turned on and surfaces have heated.
- Check to make sure that the rear leveling leg is fully inserted into the Anti-Tip bracket and that the bracket is securely installed.

5 OPERATION CHECKLIST

- Turn on one of the surface units to observe that the element glows within 60 seconds. Turn the unit off when glow is detected. If the glow is not detected within the time limit, recheck the range wiring connections. If change is required, retest again. If no change is required, have building wiring checked for proper connections and voltage.
- Check to make sure the Clock (on models so equipped) display is energized. If a series of horizontal red lines appear in the display, disconnect power immediately. Recheck the range wiring connections. If change is made to connections, retest again. If no change is required, have building wiring checked for proper connections and voltage. It is recommended that the clock be changed if the red lines appear.
- Be sure all range controls are in the OFF position before leaving the range.

Before you call for service...



Troubleshooting Tips

Save time and money! Review the charts on the following pages first and you may not need to call for service.

Problem	Possible Causes	What To Do
Radiant Cooktops		
Surface units will not maintain a rolling boil or cooking is not fast enough	Improper cookware being used.	<ul style="list-style-type: none"> Use pans which are flat and match the diameter of the surface unit selected.
Surface units do not work properly	A fuse in your home may be blown or the circuit breaker tripped.	<ul style="list-style-type: none"> Replace the fuse or reset the circuit breaker.
	Cooktop controls improperly set.	<ul style="list-style-type: none"> Check to see the correct control is set for the surface unit you are using.
Scratches (may appear as cracks) on cooktop glass surface	<p>Incorrect cleaning methods being used.</p> <p>Cookware with rough bottoms being used or coarse particles (salt or sand) were between the cookware and the surface of the cooktop.</p> <p>Cookware has been slid across the cooktop surface.</p>	<ul style="list-style-type: none"> Scratches are not removable. Tiny scratches will become less visible in time as a result of cleaning. To avoid scratches, use the recommended cleaning procedures. Make sure bottoms of cookware are clean before use, and use cookware with smooth bottoms.
Areas of discoloration on the cooktop	Food spillovers not cleaned before next use.	<ul style="list-style-type: none"> See the <i>Cleaning the glass cooktop</i> section.
	Hot surface on a model with a light-colored glass cooktop.	<ul style="list-style-type: none"> This is normal. The surface may appear discolored when it is hot. This is temporary and will disappear as the glass cools.
Plastic melted to the surface	Hot cooktop came into contact with plastic placed on the hot cooktop.	<ul style="list-style-type: none"> See the <i>Glass surface—potential for permanent damage</i> section in the <i>Cleaning the glass cooktop</i> section.
Pitting (or indentation) of the cooktop	Hot sugar mixture spilled on the cooktop.	<ul style="list-style-type: none"> Call a qualified technician for replacement.
Frequent cycling off and on of surface units	Improper cookware being used.	<ul style="list-style-type: none"> Use only flat cookware to minimize cycling.

Before you call for service...



Troubleshooting Tips

Problem	Possible Causes	What To Do
Coil Cooktops		
Surface units not functioning properly	The surface units are not plugged in solidly.	• With the controls off, check to make sure the surface unit is plugged completely into the receptacle.
	The surface unit controls improperly set.	• Check to see the correct control is set for the surface unit you are using.
	The drip pans are not set securely in the cooktop.	• With the controls off, check to make sure the drip pan is in the recess in the cooktop and that the opening in the pan lines up with the receptacle.
Oven—All Models		
Oven light does not work	Light bulb is loose or defective.	• Tighten or replace the bulb.
	Switch operating light is broken.	• Call for service.
Oven will not work	Plug on range is not completely inserted in the electrical outlet.	• Make sure electrical plug is plugged into a live, properly grounded outlet.
	A fuse in your home may be blown or the circuit breaker tripped.	• Replace fuse or reset circuit breaker.
	Oven controls improperly set.	• See the <i>Using the oven</i> section.
	On self-cleaning models, door left in the locked position.	• If necessary, allow the oven to cool then unlock the door.
Food does not bake or roast properly	Oven controls improperly set.	• See the <i>Using the oven</i> section.
	Shelf position is incorrect or the shelf is not level.	• See the <i>Using the oven</i> section.
	Incorrect cookware or cookware of improper size being used.	• See the <i>Using the oven</i> section.
	Oven thermostat needs adjustment.	• See the <i>Adjust the oven thermostat—Easy to do yourself!</i> section.
No power supply from convenience outlet on top of backguard (on some models)	Small appliance plug is not completely inserted in the convenience outlet.	• Make sure the small appliance plug is properly inserted.
	The backguard is too hot and the convenience outlet breaker has tripped.	• Allow the range to cool, then reset the circuit breaker by pressing the switch located near the convenience outlet.

Problem	Possible Causes	What To Do
Food does not broil properly	Oven is not set to BROIL .	<ul style="list-style-type: none"> On models with a temperature knob, make sure you turn it all the way to the BROIL position. On models with a BROIL pad, make sure it is turned on.
	Door not open to the broil stop position as recommended.	<ul style="list-style-type: none"> See the <i>Using the oven</i> section.
	Improper shelf position being used.	<ul style="list-style-type: none"> See the <i>Broiling guide</i>.
	Food being cooked in a hot pan.	<ul style="list-style-type: none"> For best results, use a pan designed for broiling. Make sure it is cool.
	Cookware not suited for broiling.	<ul style="list-style-type: none"> For best results, use a pan designed for broiling.
Control signals after entering cooking time or delay start	In some areas the power (voltage) may be low.	<ul style="list-style-type: none"> Preheat the broil element for 10 minutes. Broil for the longest period of time recommended in the <i>Broiling guide</i>.
	You forgot to enter a bake temperature or cleaning time.	<ul style="list-style-type: none"> Press the BAKE pad and desired temperature or the CLEAN pad and desired clean time.
Display flashes "bAd" then "linE" with a loud tone	The installed connection from the house to the unit is miswired.	<ul style="list-style-type: none"> Contact installer or electrician to correct miswire.

Before you call for service...



Troubleshooting Tips

Problem	Possible Causes	What To Do
Oven temperature too hot or too cold	Oven thermostat needs adjustment.	<ul style="list-style-type: none"> • See the <i>Adjust the oven thermostat—Easy to do yourself!</i> section.
Clock and timer do not work	Plug on range is not completely inserted in the electrical outlet.	<ul style="list-style-type: none"> • Make sure electrical plug is plugged into a live, properly grounded outlet.
	A fuse in your home may be blown or the circuit breaker tripped.	<ul style="list-style-type: none"> • Replace fuse or reset circuit breaker.
	Oven controls improperly set.	<ul style="list-style-type: none"> • See the <i>Using the clock, timer and convenience outlet</i> section.
Display goes blank	A fuse in your home may be blown or the circuit breaker tripped.	<ul style="list-style-type: none"> • Replace the fuse or reset the circuit breaker.
	The clock is turned off from showing in the display.	<ul style="list-style-type: none"> • See the <i>Using the clock, timer and convenience outlet</i> section.
Oven door is crooked	The door is out of position.	<ul style="list-style-type: none"> • Because the oven door is removable, it sometimes gets out of position during installation. To straighten the door, push down on the high corner.
Oven makes clicking noise	This is the sound of the heating element turning off and on during cooking functions.	<ul style="list-style-type: none"> • This is normal.
"F—and a number or letter" flash in the display	You have a function error code.	<ul style="list-style-type: none"> • Press the OFF pad. Put the oven back into operation.
	If the function code repeats:	<ul style="list-style-type: none"> • Disconnect all power to the range for at least 30 seconds and then reconnect power. If the function error code repeats, call for service. • On self-cleaning models, if a function error code appears during the self-cleaning cycle, check the oven door latch. The latch may have been moved, if only slightly, from the locked position. Make sure the latch is moved to the right as far as it will go. Press the OFF pad. Allow the oven to cool for one hour. Put the oven back into operation.
Power outage	Power outage or surge.	<ul style="list-style-type: none"> • Some models will automatically resume their setting once the power is restored. On models with a clock, you must reset the clock. If the oven was in use, you must reset it by pressing the OFF pad, setting the clock and resetting any cooking function.
Display flashes	Power failure.	<ul style="list-style-type: none"> • Reset the clock.
Unable to get the display to show "SF"	Oven control pads were not pressed properly.	<ul style="list-style-type: none"> • The BAKE and BROIL pads must be pressed at the same time and held for 3 seconds.

Problem	Possible Causes	What To Do
"Burning" or "oily" odor emitting from the oven vent	This is normal in a new oven and will disappear in time.	<ul style="list-style-type: none"> To speed the process, set a self-clean cycle for a minimum of 3 hours. See the <i>Using the self-cleaning oven</i> section.
Strong odor	An odor from the insulation around the inside of the oven is normal for the first few times the oven is used.	<ul style="list-style-type: none"> This is temporary.
Self-Cleaning Models		
Oven will not self-clean	The oven temperature is too high to set a self-clean operation.	<ul style="list-style-type: none"> Allow the range to cool to room temperature and reset the controls.
	Oven controls improperly set.	<ul style="list-style-type: none"> See the <i>Using the self-cleaning oven</i> section.
	Oven door is not in the locked position.	<ul style="list-style-type: none"> Make sure you move the door latch handle all the way to the right.
Oven starts a self-clean cycle when you wanted to bake, roast or broil	Oven door locked during cooking.	<ul style="list-style-type: none"> Turn the Oven Temperature knob to OFF. Allow the oven to cool. Never force the door latch handle.
"Crackling" or "popping" sound	This is the sound of the metal heating and cooling during both the cooking and cleaning functions.	<ul style="list-style-type: none"> This is normal.
Excessive smoking during a clean cycle	Excessive soil.	<ul style="list-style-type: none"> Press the OFF pad. Open the windows to rid the room of smoke. Wait until the light on the CLEAN pad goes off. Wipe up the excess soil and reset the clean cycle.
Oven door will not unlock	Oven too hot.	<ul style="list-style-type: none"> Allow the oven to cool below locking temperature.
Oven not clean after a clean cycle	Oven controls not properly set.	<ul style="list-style-type: none"> See <i>Using the self-cleaning oven</i> section.
	Oven was heavily soiled.	<ul style="list-style-type: none"> Clean up heavy spillovers before starting the clean cycle. Heavily soiled ovens may need to self-clean again or for a longer period of time.

Accessories.



Looking For Something More?

To inquire about purchasing a part or an accessory for your appliance, call our National Parts Centre at **1.800.661.1616**.

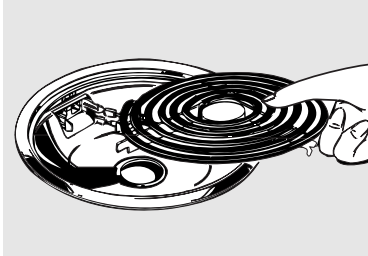

Surface Elements & Drip Pans

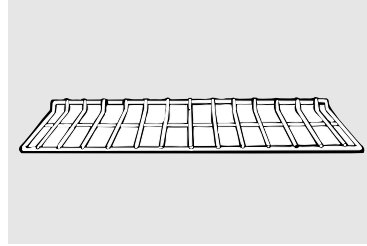

Oven Racks

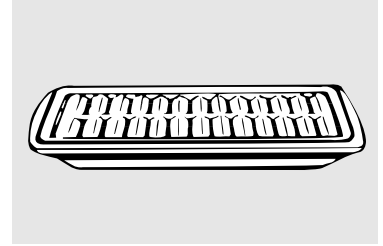

Broiler Pan

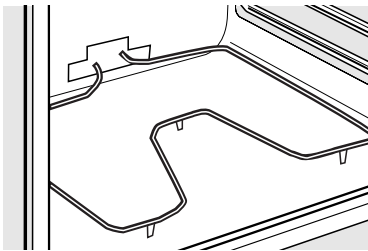

Oven Elements

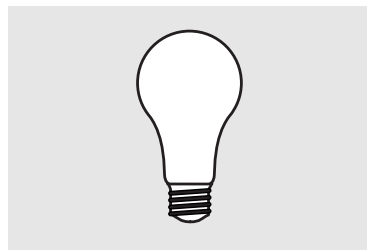

Light Bulbs

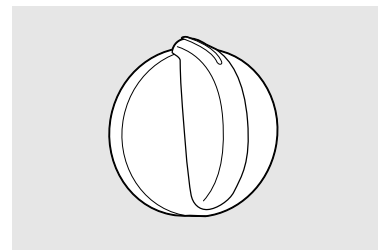

Knobs



Cleaner

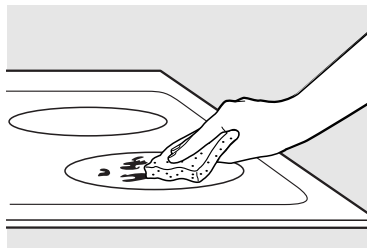

Cleaning Pads

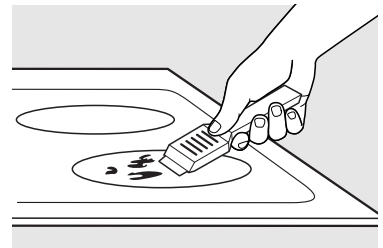

Scraper

Tired of discolored racks? Wishing you had extra-heavy-duty oven racks?

NOW AVAILABLE for your range:

Our innovative, self-cleanable porcelain-coated oven racks!

- Heavy Duty
- Durable
- Able to be cleaned in a self-cleaning oven

Please place in envelope and mail to:
Veuillez mettre dans une enveloppe et envoyez à :

**OWNERSHIP REGISTRATION
P.O. BOX 1780
MISSISSAUGA, ONTARIO
L4Y 4G1**

(FOR CANADIAN CONSUMERS ONLY)



For Canadian
Customers



Pour les
Consommateurs
Canadiens

CUT ALONG THIS LINE AND RETURN CARD—THANKS

OWNERSHIP REGISTRATION CERTIFICATE – FICHE D'INSCRIPTION DU PROPRIÉTAIRE

Please register your product to enable us to contact you in the remote event a safety notice is issued for this product and to allow for efficient communication under the terms of your warranty, should the need arise.

Veuillez enregistrer votre produit afin de nous permettre de communiquer avec vous si jamais un avis de sécurité concernant ce produit était émis et de communiquer facilement avec vous en vertu de votre garantie, si le besoin s'en fait sentir.

REGISTER ON-LINE: www.geappliances.ca		MAIL TO: P.O. BOX 1780, MISSISSAUGA	
ENREGISTREMENT SUR INTERNET À: www.electromenagersge.ca		POSTER À: ONTARIO, L4Y 4G1	
<input type="checkbox"/> MR./M	<input type="checkbox"/> MRS./MME.	FIRST NAME / PRÉNOM	LAST NAME / NOM
<input type="checkbox"/> MISS/Mlle.	<input type="checkbox"/> MS.		
STREET NO / N° RUE	STREET NAME / RUE		APT. NO / APP. / RR#
CITY / VILLE		PROVINCE	POSTAL CODE / POSTAL
AREA CODE / IND. RÉG.	TELEPHONE	E-MAIL	
DID YOU PURCHASE A SERVICE CONTRACT FOR THIS APPLIANCE? AVEZ-VOUS ACHETÉ UN CONTRAT DE SERVICE POUR CET APPAREIL ?		YES / OUI <input type="checkbox"/>	IF YES / SI OUI: EXPIRATION
		NO / NON <input type="checkbox"/>	Y/A M D/J
NAME OF SELLING DEALER / NOM DU MARCHAND		MODEL / MODÈLE	
INSTALLATION DATE / DATE D'INSTALLATION Y/A M D/J		CORRESPONDENCE <input type="checkbox"/> ENGLISH CORRESPONDANCE <input type="checkbox"/> FRANÇAIS	SERIAL / SÉRIE
<input type="checkbox"/> I do not wish to receive any promotional offers regarding this product. <input type="checkbox"/> Je ne désire pas recevoir d'offres promotionnelles concernant ce produit.			

Electric Range Warranty.



All warranty service provided by our Factory Service Centres, or an authorized Customer Care® technician. To schedule service, 24 hours a day, call 1.800.361.3400. Please have serial number and model number available when calling for service.

Staple your receipt here. Proof of the original purchase date is needed to obtain service under the warranty.

For The Period Of:	Mabe Will Provide:
One Year From the date of the original purchase	Any part of the range which fails due to a defect in materials or workmanship. During this limited one-year warranty , Mabe will also provide, free of charge , all labor and related service to replace the defective part.

What Mabe Will Not Cover:

- | | |
|---|--|
| <ul style="list-style-type: none"> ■ Service trips to your home to teach you how to use the product. ■ Improper installation, delivery or maintenance. ■ Failure of the product if it is abused, misused, or used for other than the intended purpose or used commercially. ■ Damage to the glass cooktop caused by use of cleaners other than the recommended cleaning creams and pads. ■ Damage to the glass cooktop caused by hardened spills of sugary materials or melted plastic that are not cleaned according to the directions in the Owner's Manual. | <ul style="list-style-type: none"> ■ Replacement of house fuses or resetting of circuit breakers. ■ Damage to the product caused by accident, fire, floods or acts of God. ■ Incidental or consequential damage caused by possible defects with this appliance. ■ Damage caused after delivery. ■ Product not accessible to provide required service. |
|---|--|

EXCLUSION OF IMPLIED WARRANTIES—Your sole and exclusive remedy is product repair as provided in this Limited Warranty. Any implied warranties, including the implied warranties of merchantability or fitness for a particular purpose, are limited to one year or the shortest period allowed by law.

This warranty is extended to the original purchaser and any succeeding owner for products purchased for ordinary home use within Canada. In-home warranty service will be provided in areas where it is available and deemed reasonable by Mabe to provide.

Some provinces do not allow the exclusion or limitation of incidental or consequential damages, so the above exclusion may not apply to you. This warranty gives you specific legal rights, and you may also have other rights which vary from province to province. To know what your legal rights are in your province, consult your local or provincial consumer affairs office.

**Warrantor: Mabe Canada Inc.,
Burlington, Ontario**

Safety Instructions
Operating Instructions
Care and Cleaning
Installation Instructions
Troubleshooting Tips
Consumer Support

Consumer Support.

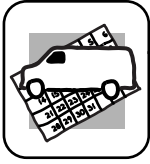

Schedule Service

Expert repair service is only one step away from your door. Call 1.800.361.3400, 24 hours a day, 7 days a week.

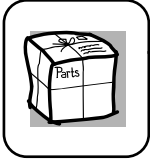

Parts and Accessories

To inquire about purchasing a part or an accessory for your appliance, call our National Parts Centre at 1.800.661.1616.



Contact Us

www.moffatappliances.ca

If you are not satisfied with the service you receive, contact us on our Website with all the details including your phone number, or write to:

Mabe Canada Inc.
1 Factory Lane
Moncton, New Brunswick
E1C 9M3