

# Panasonic®

**Owner's Manual**  
**Countertop Induction Oven**  
**Household Use Only**  
**Model No. NU-HX100S**



**PLEASE READ THESE INSTRUCTIONS CAREFULLY BEFORE USING THIS PRODUCT,  
AND SAVE THIS MANUAL FOR FUTURE USE.**

**To register your product and for all other assistance, please contact us via the web at:**

<http://shop.panasonic.com/support> (U.S.A Only)

**Para obtener instrucciones en español, por favor visite la página web en:**

<http://shop.panasonic.com/support>

F0003BV00AP  
PA0716-0  
Printed in China

© Panasonic Appliances Microwave Oven (Shanghai) Co., Ltd. 2016

# CONTENTS

## Safety Information

IMPORTANT SAFETY INSTRUCTIONS .....	1
IMPORTANT SAFEGUARDS .....	2
SAFEGUARDS .....	3
Safety Precautions.....	4
Grounding Instructions .....	4
Installation .....	5
General Use.....	5-6
Food Preparation.....	6

## Operation

Location of Controls .....	8
Grill Pan .....	9
Control Panel.....	10
Display Window .....	10
Cook Mode.....	11
IH (Induction Heating) Cooking Mechanism .....	11
Operation .....	12-25
Using the Oven for the First Time .....	12
Setup Feature .....	12-13
Demo Mode .....	14
Setting the Child Safety Lock.....	14
Grill Feature.....	15
Keep Warm Feature .....	16
Broil Feature.....	17
Combo Feature .....	18-19
Bake Feature .....	20
Setting the Timer .....	21
Adding Time .....	21
Auto Cook.....	22-25
Cooking Chart.....	26-30
Food Characteristics .....	31

## Maintenance

Care and Cleaning of Your Oven.....	32-33
Before Requesting Service .....	33-34
Shop Accessories .....	34
Limited Warranty (ONLY FOR U.S.A.) .....	35

## General Information

Cookware Guide .....	7
Specifications .....	36
User's Record.....	36



## IMPORTANT SAFETY INSTRUCTIONS

### Your safety and the safety of others are very important.



We have provided important safety messages in this manual and on your appliance. Always read and obey all safety messages.

This is the safety alert symbol. It is used to alert you to potential hazards that can kill or hurt you and others.

All safety messages will follow the safety alert symbol and either the word “DANGER”, “WARNING” or “CAUTION”. These words mean:

#### **DANGER**

You can be killed or seriously injured if you don't immediately follow instructions.

#### **WARNING**

You can be killed or seriously injured if you don't follow instructions.

#### **CAUTION**

You can be exposed to a potentially hazardous situation which, if not avoided, may result in minor or moderate injury.

All safety messages will tell you what the potential hazard is, tell you how to reduce the chance of injury, and tell you what can happen if the instructions are not followed.

## Thank you for purchasing a Panasonic Countertop Induction Oven

Your oven is a cooking appliance and you should use as much care as you use with a stove or any other cooking appliance. When using this electric appliance, basic safety precautions should be followed, including the following:

### **WARNING**

**Inspection for Damage — The oven should only be used if an inspection confirms all of the following conditions:**

1. The grille is not damaged or broken.
2. The oven door fits squarely and securely and opens and closes smoothly.
3. The oven door hinges are in good condition.
4. The metal plates of a metal seal on the oven door are neither buckled nor deformed.
5. The oven door seals are neither covered with food nor have large burn marks.

# IMPORTANT SAFEGUARDS



To reduce the risk of burns, electric shock, fire or injury to persons:

1. Read all instructions before using this appliance.
2. **DO NOT** touch hot surfaces. Use handles or knobs.
3. To protect against electrical shock **DO NOT** immerse cord, plugs in water or other liquid.
4. Close supervision is necessary when any appliance is used by or near children.
5. Unplug from outlet when not in use and before cleaning. Allow to cool before putting on or taking off parts.
6. **DO NOT** operate this appliance if it has a damaged cord or plug, if it is not working properly, or if it has been damaged or dropped. It is dangerous for anyone other than a service technician trained by the manufacturer to perform repair service.
7. The use of accessory attachments not recommended by the appliance manufacturer may cause injuries.
8. **DO NOT** store or use this appliance outdoors. **DO NOT** use this product near water (for example, near a kitchen sink, in a wet basement, or near a swimming pool or similar locations).
9. **DO NOT** let cord hang over edge of a table or counter, or touch hot surfaces.
10. **DO NOT** place this appliance on or near a hot gas or electric burner, or in a heated oven. Install or locate this appliance only in accordance with the installation instructions found on page 5.
11. Extreme caution must be used when moving an appliance containing hot oil or other hot liquids.
12. Use this appliance only for its intended use as described in this manual. **DO NOT** use appliance for other than intended use. **DO NOT** use corrosive chemicals, vapors or non-food products in this appliance. This type of oven is specifically designed to heat or cook food. It is not designed for industrial or laboratory use. The use of corrosive chemicals in heating or cleaning will damage the appliance.
13. Use extreme caution when removing tray or disposing of hot grease.
14. **DO NOT** clean with metal scouring pads. Pieces can break off the pad and touch electrical parts involving a risk of electric shock.
15. Extreme caution should be exercised when using containers constructed of other than metal or glass.
16. To reduce the risk of fire in the oven cavity:
  - (a) **DO NOT** overcook food. Carefully attend appliance when combustible materials are placed inside the oven to facilitate cooking.
  - (b) **If material inside the oven ignites, keep the oven door closed, turn oven off, and disconnect the power cord.**
  - (c) **DO NOT** use the cavity for storage purposes. **DO NOT** store any materials, other than manufacturers recommended accessories, in this oven when not in use.
  - (d) **DO NOT** place any of the following materials in the oven: that is **paper, cardboard, plastic, and the like.**
  - (e) A fire may occur if the oven is covered or touching flammable material, including curtains, draperies, walls, and the like, when in operation. **DO NOT** store any item on top of the appliance when in operation.
  - (f) **DO NOT** cover the Grill Pan or any part of the oven with metal foil. This will cause overheating of the oven.
17. **DO NOT** Cook on Broken oven cavity floor – If oven cavity floor should break, cleaning solutions and spill overs may penetrate the broken oven cavity floor and create a risk of electric shock.
18. Clean oven cavity floor with Caution – If a wet sponge or cloth is used to wipe spills on a hot cooking area, be careful to avoid steam burn, some cleaners can produce noxious fumes if applied to a hot surface.
19. **DO NOT** place metallic objects such as knives, forks, spoons and lids on the oven cavity floor since they can get hot.

## SAVE THESE INSTRUCTIONS

For proper use of your oven, read remaining safety cautions and the Owner's Manual.

# SAFEGUARDS

20. This appliance must be grounded. Connect only to a properly grounded outlet. See "**GROUNDING INSTRUCTIONS**" found on page 4.
21. **DO NOT** cover or block any openings on this appliance.
22. This appliances are not intended to be operated by means of an external timer or separate remote-control system.
23. **DO NOT** cook directly on the oven cavity floor. It can crack, and cause injury or damage to the oven. Always put food directly on the Grill Pan on the centre of Oven Cavity Floor.
24. As with any cooking appliance, **DO NOT** leave oven unattended while in use.
25. Oversize foods must not be inserted in the oven as they may create a fire or risk of electric shock.
26. Take CAUTION when sliding out the Grill Pan from oven, do not let the Grill Pan rest half way on the inside the oven. The inside the oven is not designed with a stop-lock and it can not hold the Grill Pan.
27. When cleaning surfaces of the oven door and oven that come together on closing the oven door, use only mild, non-abrasive soaps or detergents applied with a sponge or soft cloth.
28. The door seals and door seal areas should be cleaned with a damp cloth. The appliance should be inspected for damage to the door seals and door seal areas and if these areas are damaged the appliance should not be operated until it has been repaired by a service technician trained by the manufacturer.
29. Keep cord away from heated surfaces.
30. If the supply cord of this appliance is damaged, it must be replaced with the special cord available from the manufacturer. It is dangerous for anyone other than a service technician trained by the manufacturer to perform repair service.
31. **DO NOT** attempt to tamper with or make any adjustments or repairs to the oven door, the control panel housing, safety interlock switches or any other part of the oven. Repairs should only be done by a qualified service technician.
32. This appliance should be serviced only by qualified service personnel. Contact the nearest authorized service center for examination, repair or adjustment.
33. **DO NOT** allow children to use this appliance, unless closely supervised by an adult. **DO NOT** assume that because a child has mastered one cooking skill he/she can cook everything.
34. This appliance is not intended for use by persons (including children) with reduced physical, sensory or mental capabilities, or lack of experience and knowledge unless they have been given supervision or instruction concerning use of the appliance by a person responsible for their safety. Young children should be supervised to ensure that they do not play with the appliance.
35. Exterior oven surfaces, including air vents on the cabinet and the oven door will get hot during Bake, Grill, Combo, Broil or Auto functions. To prevent burns, take care when opening or closing the oven door and when inserting or removing food and accessories.
36. The oven has heaters situated in the top of the oven. During and after using either the Bake, Combo, Broil or Auto functions, all inside surfaces of the oven will be very hot. To prevent burns, care should be taken to avoid touching the inside surfaces of the oven.
37. **DO NOT** use the Grill Pan in a microwave oven, conventional oven or open flame burner. The Grill Pan is designed for use only with NU-HX100S oven.

**Attention: Hot Surfaces**



# **WARNING**

## Safety Precautions

### TO AVOID THE RISK OF SHOCK:

**DO NOT** remove outer panel from oven. **DO NOT** tamper with, or make any adjustments or repairs to the oven door, the control panel frame, safety interlock switches, or any other part of oven. Repairs must be done only by a qualified service person.

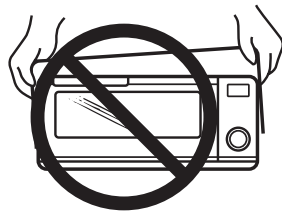

### TO AVOID THE RISK OF FIRE:

1. **DO NOT** store flammable materials next to, on top of, or in the oven.
2. **DO NOT** dry clothes, newspapers or other materials in the oven, or use newspaper or paper bags for cooking.
3. **DO NOT** hit or strike the control panel. Damage to controls may occur.



4. **DO NOT** use recycled paper products unless the paper product is labeled as safe for oven use. Recycled paper products may contain impurities, which may cause fire.

### TO AVOID THE RISK OF SCALDING:

1. OVEN GLOVES should always be used when removing items from the oven. See page 9 for more information. Heat is transferred from the Grill Pan to the cooking food and the Oven Cavity Floor. The Oven Cavity Floor can also be very HOT after removing the Grill Pan or cooking container from the oven.
2. Please use caution when touching accessible parts when oven is operated in Bake, Grill, Combo, Broil or Auto feature, because the accessible parts may become extremely hot.



## Grounding Instructions

### **WARNING: IMPROPER USE OF THE GROUNDING PLUG CAN RESULT IN A RISK OF ELECTRIC SHOCK.**

Consult a qualified electrician or service person if the grounding instructions are not completely understood, or if doubt exists as to whether the appliance is properly grounded. If it is necessary to use an extension cord, use only a three-wire extension cord that has a three-prong polarized grounding plug, and a three-slot receptacle that will accept the plug of the appliance. The marked rating of the extension cord should be equal to or greater than the electrical rating of the appliance.

### Grounding Instructions

#### **THIS APPLIANCE MUST BE GROUNDED.**

In the event of an electrical short circuit, grounding reduces the risk of electric shock by providing an escape wire for the electric current. This appliance is equipped with a cord having a grounding wire with a grounding plug. The plug must be plugged into an outlet that is properly installed and grounded.

- **Plug into properly installed and grounded three-prong outlet.**
- **DO NOT** remove ground prong.
- **DO NOT** use an adapter.

### Power Supply

1. A short power-supply cord (or detachable power-supply cord) is provided to reduce the risk resulting from becoming entangled in or tripping over a longer cord.
2. The cord should be arranged so that it will not drape over the countertop or tabletop where it can be pulled on by children or tripped over unintentionally.
3. The use of extension cords is not recommended.

### Wiring Requirements

1. The oven must be operated on a SEPARATE CIRCUIT. No other appliance should share the circuit with the oven. If it does, the branch circuit fuse may blow or the circuit breaker may trip.
2. The oven must be plugged into a 15 AMP or 20 AMP, 120 VOLT, 60 Hz GROUNDED OUTLET. Where a standard two-prong outlet is encountered, it is the personal responsibility and obligation of the consumer to have it replaced with a properly grounded three-prong outlet.
3. The VOLTAGE used must be the same as specified on this oven (120 V, 60 Hz). Using a higher voltage is dangerous and may result in a fire or oven damage. Using a lower voltage will cause slow cooking. Panasonic is NOT responsible for any damages resulting from the use of the oven with any voltage other than specified.



# Installation

## Examine Your Oven

Unpack oven, remove all packing material and examine the oven for any damage such as dents, broken door latches or cracks in the oven door. Notify dealer immediately if oven is damaged. **DO NOT** install if oven is damaged.

## Placement of Oven

1. The oven must be placed on a flat, stable surface, which is 91.6 cm (36") height from the ground. Place the front surface of the oven door three inches or more from the counter top edge to avoid accidental tipping of the oven during normal use. For proper operation, the oven must have sufficient air flow. **Allow 15 cm (6") of space on the top of the oven, 10 cm (4") on the left and the**

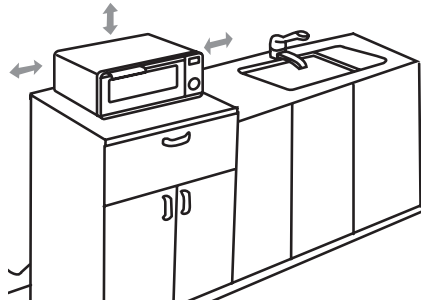

**other side being open. If one side of the oven is placed flush against wall, the other side or the top must not be blocked. Do not remove the bottom feet from the oven.**

- (a) **DO NOT** block air vents. If they are blocked during operation, the oven may overheat and be damaged.
  - (b) **DO NOT** place oven near a hot, damp surface such as a gas or electric range, sink, or dishwasher.
  - (c) **DO NOT** operate oven when room humidity is excessive.
2. This oven is manufactured for household use only. It is not approved or tested for mobile vehicle, marine, or commercial use.

## Installation

**DO NOT** block air vents. If they are blocked during operation, the oven may overheat. If the oven overheats, a thermal safety device will turn the oven off. The oven will remain inoperable until it has cooled.



# General Use

## TV / RADIO / WIRELESS EQUIPMENT INTERFERENCE

1. This product has been tested and found to comply with the limits for the Oven, pursuant to Part 18 of the FCC Rules. This product can radiate radio frequency energy, which could cause interference to such products as radio, TV, baby monitor, cordless phone, Bluetooth, wireless router, hearing aids, etc., which can be confirmed by turning this product off and on. Cards with magnetic strips such as store or bank cards, may be erased or damaged. If present, the user is encouraged to try to correct by taking one or more of the following countermeasures:
  - (a) Increase the spacing distance between the oven and other product receiving the interference.
  - (b) If possible, use a properly installed receiver antenna and/or reorient the receiving antenna of the other product receiving the interference.
  - (c) Plug the oven into a different outlet from the other product receiving the interference.
  - (d) Clean the oven door and sealing surfaces of the oven. (See Care and Cleaning of Your Oven)

## CAUTION:

If you are wearing a medical device (such as a pacemaker), consult your doctor. The operation of the appliance may affect the medical device.

## General Guidelines

1. This oven is specifically designed to heat or cook food. **DO NOT** use this oven to heat chemicals or other non-food products.
2. Before use, check that utensils/containers are suitable for use in oven.
3. **DO NOT** poke an object through a grille or between the oven door and the oven while the oven is operating.
4. Always use the oven with the Grill Pan, don't use any other container directly on the oven cavity floor.
5. In order to maintain high quality, **DO NOT** operate the oven when empty unless specifically allowed in the manufacturer's literature.
6. **DO NOT** attempt to use this oven to dry newspaper, clothing or any other materials. They may catch fire.
7. When the oven is not being used, **DO NOT** store any objects other than oven accessories inside the oven in case it is accidentally turned on.
8. Extreme caution must be used when moving hot liquids.
9. When taking out cooking containers take care not to let the contents spill.
10. Avoid hot steam, serious burns and scalds could result.
11. To prevent injury, Do not allow anyone to lean, hang, sit or place heavy items on the open oven door of the appliance. Severe personal injury could result.
12. Clean the oven cavity, the oven door and the seals with water and a mild detergent at regular intervals. **DO NOT** use any form of abrasive cleaner that may scratch or scour surfaces around the oven door.
13. **DO NOT** use a steam cleaner to clean this appliance. The steam from the cleaning appliance could penetrate live components and permanently damage the oven or cause injury.
14. The use of accessories not recommended by Panasonic may cause injury.



## General Use (continued)

### Fan Motor Operation

After using the oven repeatedly or for long time, the fan may operate to cool the electric components. This is perfectly normal, and you can take out the food from the oven while the fan operates.

It is recommended to keep the oven plugged in until the Fan Motor completely stops operating.

### Before Using Your Oven

Before using the oven for the first time, wipe excessive oil off in the oven cavity and operate the oven without food on Combo 1 for 5 minutes with the Grill Pan on the Oven Cavity Floor. This will allow the oil that is used for rust protection to be burned off. This is the only time the oven is used without food. (with the exception of preheating on Bake and Grill feature)

### Oven Light

Not User Replaceable. When it becomes necessary to replace the oven light, please consult Panasonic for the nearest authorized service centre for examination or repair. Contact information is provided in the warranty page 35.

## Food Preparation

Follow these Safety Precautions when cooking in your oven.

### **IMPORTANT**

Proper cooking depends upon the power, the time setting and quantity of food. If you use a smaller portion than recommended but cook at the time for the recommended portion, fire could result.

#### 1) HOME CANNING / STERILIZING / DRYING FOODS / SMALL QUANTITIES OF FOODS

- **DO NOT** use your oven for home canning. Your oven cannot maintain the food at the proper canning temperature. The food may be contaminated and then spoil.
- **DO NOT** use the oven to sterilize objects (baby bottles, etc.). It is difficult to keep the oven at the high temperature needed for sterilization.
- **DO NOT** dry meats, herbs, fruits or vegetables in your oven. Small quantities of food or foods with low moisture content can dry out, scorch or catch on fire if overheated.

#### 2) DEEP FAT FRYING

- **DO NOT** deep fat fry in your oven. Cooking oils may burst into flames and may cause damage to the oven and may result in burns.

#### 3) OVEN CAVITY FLOOR

- Cooking containers get hot during cooking. Heat is transferred from the HOT food to the container and the Oven Cavity Floor. Use oven gloves when removing containers from the oven or when removing lids from cooking containers, to avoid burns.
- The Oven Cavity Floor will get hot during cooking. It should be allowed to cool before handling.

#### 4) PAPER TOWELS / CLOTHS

- **DO NOT** use paper towels or cloths that contain a synthetic fiber woven into them. The synthetic fiber may cause the towel to ignite. Use paper toweling under supervision.

#### 5) OVEN COOKING BAGS

- **DO NOT** use cooking bags, unless it is heat-proof.

#### 6) THERMOMETERS

- **DO NOT** put thermometers in your oven when cooking. After cooking, verify food by an instant read thermometer.

#### 7) BABY FORMULA / BABY FOOD

- **DO NOT** heat baby formula or baby food in the oven. The glass jar or surface of the food may appear warm while the interior can be so hot as to burn the infant's mouth and esophagus.

#### 8) REHEATING PASTRY PRODUCTS

- When reheating pastry products, check temperatures of any fillings before eating.

#### 9) GENERAL OVEN USAGE GUIDELINES

- **DO NOT** use the oven for any purpose other than the preparation of food.



# Cookware Guide

## Caution:

Place all cookware on the Grill Pan when you are cooking. It is dangerous to use cookware (specifically for metal ware) directly on the oven cavity floor. Do not use commercial IH containers directly on the oven cavity floor.

## Plastic wrap

**NO.** Plastic wrap will melt under a high temperature.



## Wax Paper

**NO.** Note: Wax paper that has undergone heat resistant treatment can be used.



## Non-heat resistant glass containers

**NO.** Glass will be broken under a high temperature.



## Towels & Napkins

**NO.** They may cause a fire in the oven.



## Plastic containers

**NO.** Plastic will melt under a high temperature.



## Frozen Dinner Trays

Metal Tray: **YES.** Use together with the Grill Pan.



Plastic Tray: **NO.**

## Brown Paper Bags

**NO.** They may cause a fire in the oven.



## Aluminum and other metal containers

**YES.** Use together with the Grill Pan. Meal containers with resin handles cannot be used.



## Lacquerware

**NO.**



## Heat-proof silica gel container

**YES.** Only use in Bake mode. Check heat-resistant temperature of silica gel container before baking.



## Oven Cooking Bag

**NO.** Note: Cooking bag that have undergone heat resistant treatment can be used.

## Heat Resistant Oven Glassware/Ceramic

**YES.**



## Wood • bamboo • paper containers

**NO.** Note: Paper containers that have undergone heat resistant treatment can be used.



## Aluminum foil (Household aluminum foil)

**YES.**



## Disposable Polyester Paperboard Dishes

**NO.** They may cause a fire in the oven.



## Thermometers

**ONLY** use instant read thermometer after cooking.



# Location of Controls

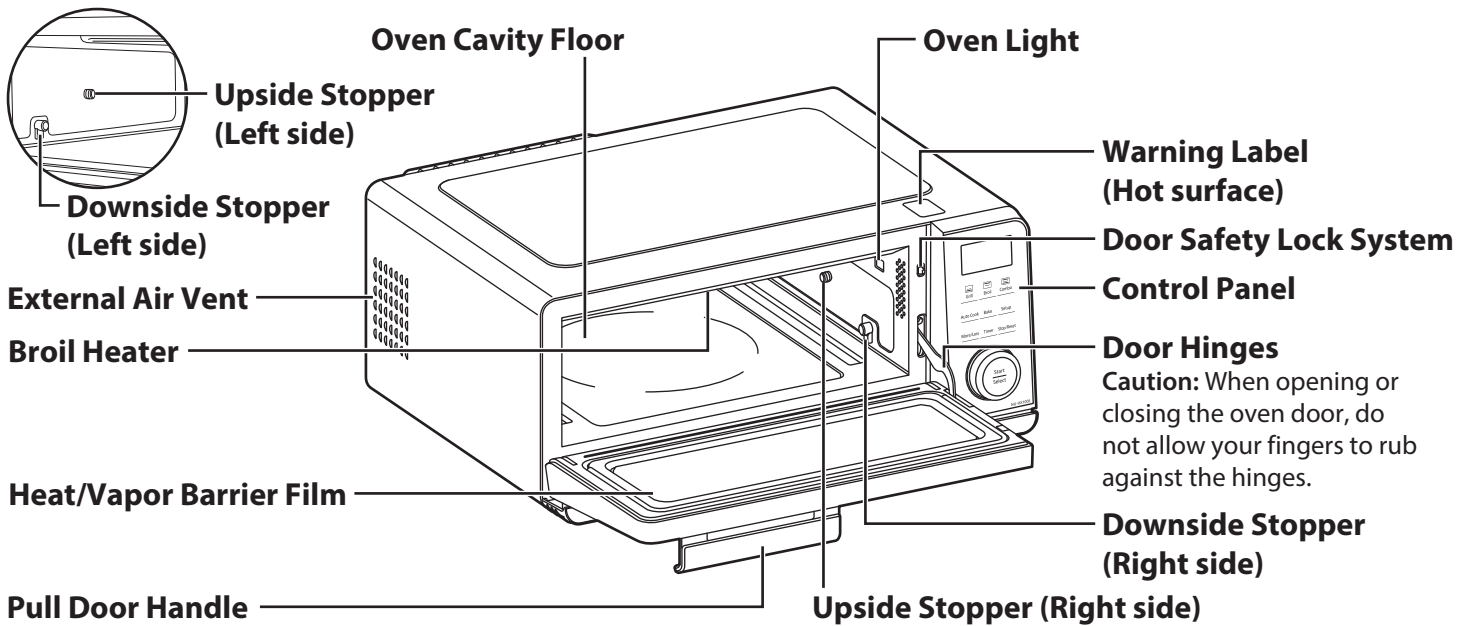

Pull to open the oven door. Opening the oven door during cooking will stop the cooking process without cancelling the program. Cooking resumes as soon as the oven door is closed and **Start/Select Dial** is pressed. It is quite safe to open the oven door at any time during a cooking program.

## NOTE:

The illustration is for reference only.

## Oven Light:

The oven light will turn on during cooking and also when the oven door is opened.

## Caution:

1. There is a heater protector around the broil heater, and it gets very hot. Care should be taken when you remove the food from oven.
2. The weight borne by the oven door cannot exceed 10 lb. Do Not ride or hang on the oven door.

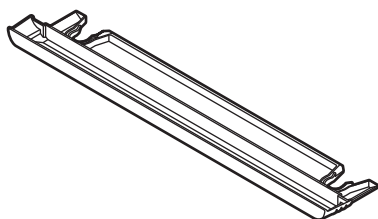
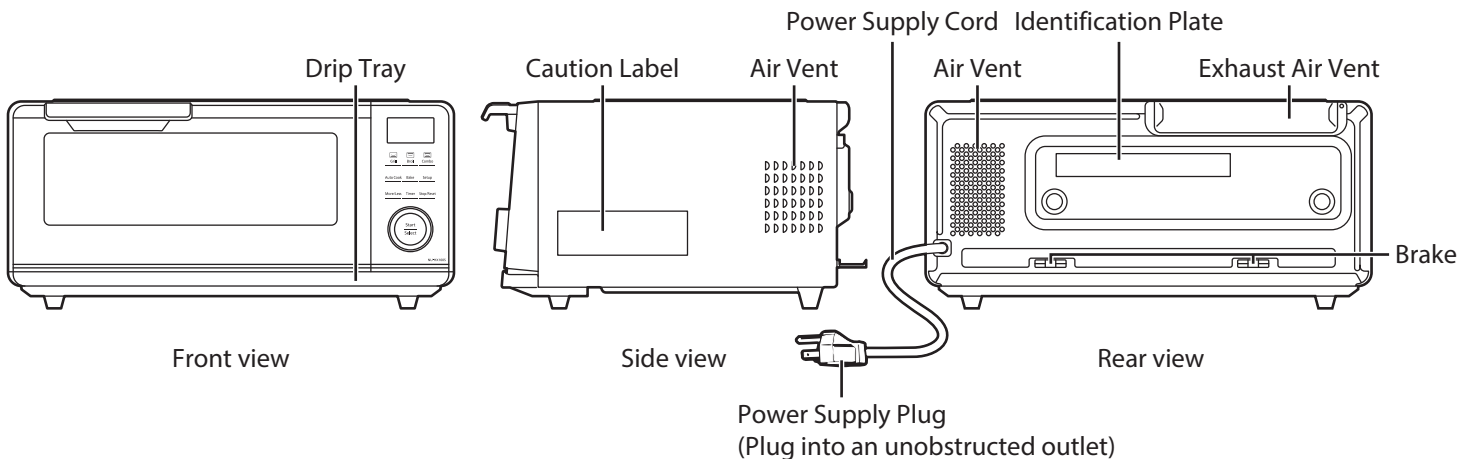

## Drip Tray

1. Before using the oven, the drip tray must be fitted as it collects excess water during cooking. The drip tray should be removed and cleaned on a regular basis.
2. Fit the drip tray by holding with both hands and clicking onto the front legs of the oven.
3. To remove the drip tray, hold with both hands and gently pull or release forward. Wash in warm soapy water. Re-position the drip tray by clicking back onto the legs.
4. DO NOT USE A DISHWASHER TO CLEAN THE DRIP TRAY.

# Grill Pan

When cooking directly on the Grill Pan, please arrange your food by following the illustrations below and illustrations on pages on 23 through 25.

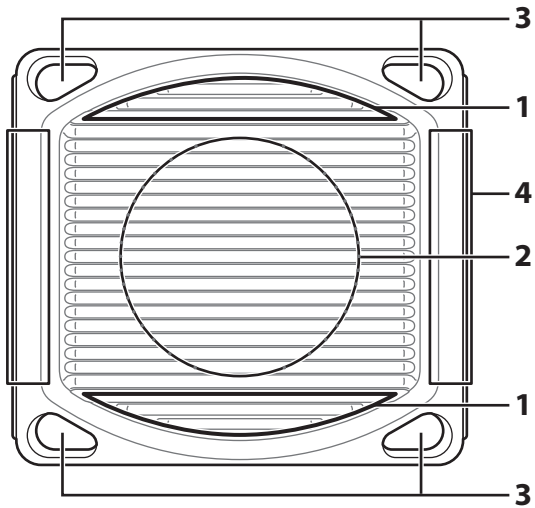

## 1. Water pocket

When cooking toast or bagel, please add the water in this area.

## 2. High power Area

When cooking chicken, fish or meat etc., please put it in this area.

## 3. Handle

## 4. Holder

### Caution:

1. Use oven gloves when removing the Grill Pan as it will be very hot.
2. Do Not put the Grill Pan directly on table after cooking. The high temperature will damage the surface of the table. Always use a heat-proof pot mat.
3. Do Not hook the Grill Pan.
4. Do Not put it on the oven door for a long time.
5. The maximum weight can be used on the Grill Pan is 3.3 lb.
6. DO NOT use the Grill Pan in a microwave oven, conventional oven or open flame burner. The Grill Pan is designed for use only with NU-HX100S oven.

For there are two upside stoppers on the both sides of the oven, care should be taken when you put the Grill Pan into the oven. Please see the guidelines below:

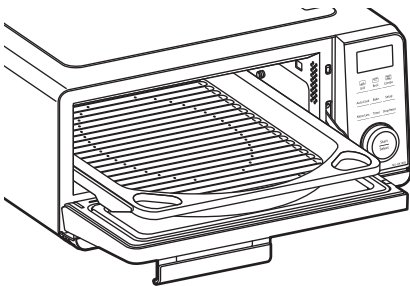

Put the Grill Pan on the oven door.

\* The edge of the Grill Pan can't be over the edge of the oven door.

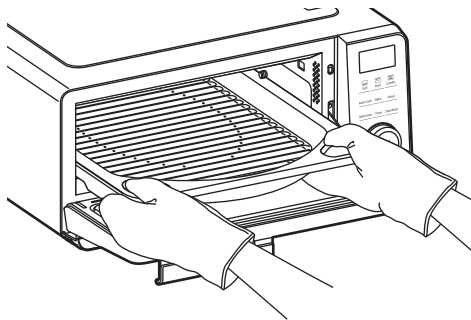

Push the Grill Pan into the oven.

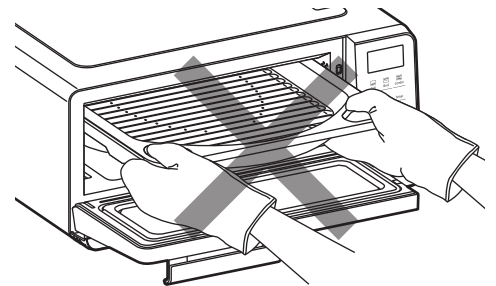

**DO NOT** let the Grill Pan higher than the upside stoppers when you put it into oven.

The Grill Pan is very heavy, so care should be taken when you remove food from the oven. Please see the guidelines below:

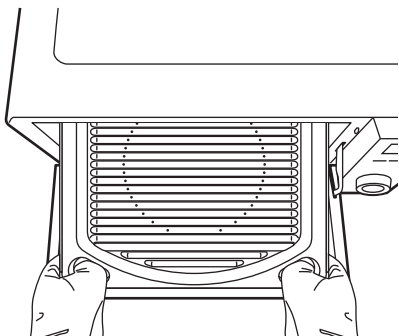

Using your finger to hook the handle on the Grill Pan. Pull forward until caught by the downside stopper.

\*For some menus boiling water may still be in the water pocket, do not put your finger in it.

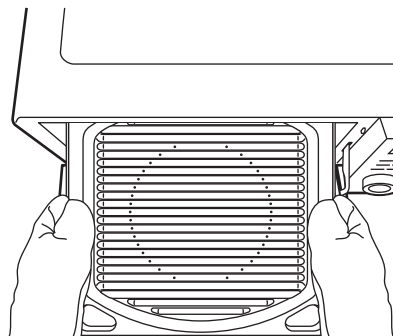

Take out the Grill Pan, using holder with both hands.

## Control Panel

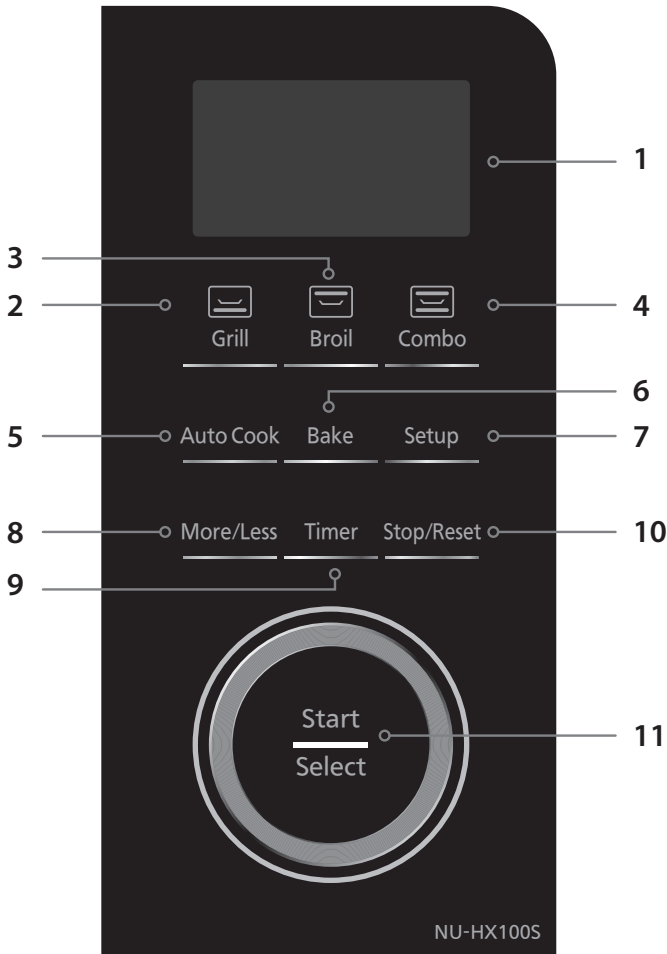

- 1 Display Window (See page 10)
- 2 Grill Pad (See page 15-16)
- 3 Broil Pad (See page 17)
- 4 Combo Pad (See page 18-19)
- 5 Auto Cook Pad (See page 22-25)
- 6 Bake Pad (See page 20)
- 7 Setup Pad (See page 12-13)
- 8 More/Less Pad (See page 22)
- 9 Timer Pad (See page 21)
- 10 Stop/Reset Pad

**Before cooking:** One press clears all your instructions.  
**During cooking:** One press temporarily stops the cooking process. Another press cancels all your instructions, and a "0" will appear in the display window.

### 11 Start/Select Dial

**Rotate Start/Select Dial** to select the power level, temperature, weight, time and auto cook.  
 After cooking program setting, **press** the **Start/Select Dial** to begin operation. If the oven door is opened or **Stop/Reset Pad** is pressed once during cooking, **Start/Select Dial** must be pressed again to restart cooking.  
 The light on the control panel will prompt you to **press** or **rotate Start/Select Dial**.

### Beep Sound:

When a pad is pressed correctly, a beep will be heard. If a pad is pressed and no beep is heard, the unit did not or cannot accept the instruction. At the end of any complete program, the oven will beep 5 times.

### NOTE:

1. If no operation is selected, after the cooking program is set, after 6 minutes the oven will automatically cancel the cooking program.
2. If the last operation has completed with the oven door closed, after about 6 minutes, the oven will enter stand-by mode. When in stand-by mode, nothing appears in the display window.
3. When in stand-by mode, it is necessary to open the oven door before operating the oven.

## Display Window

To help you operate the oven conveniently, the present state will appear in the display window.

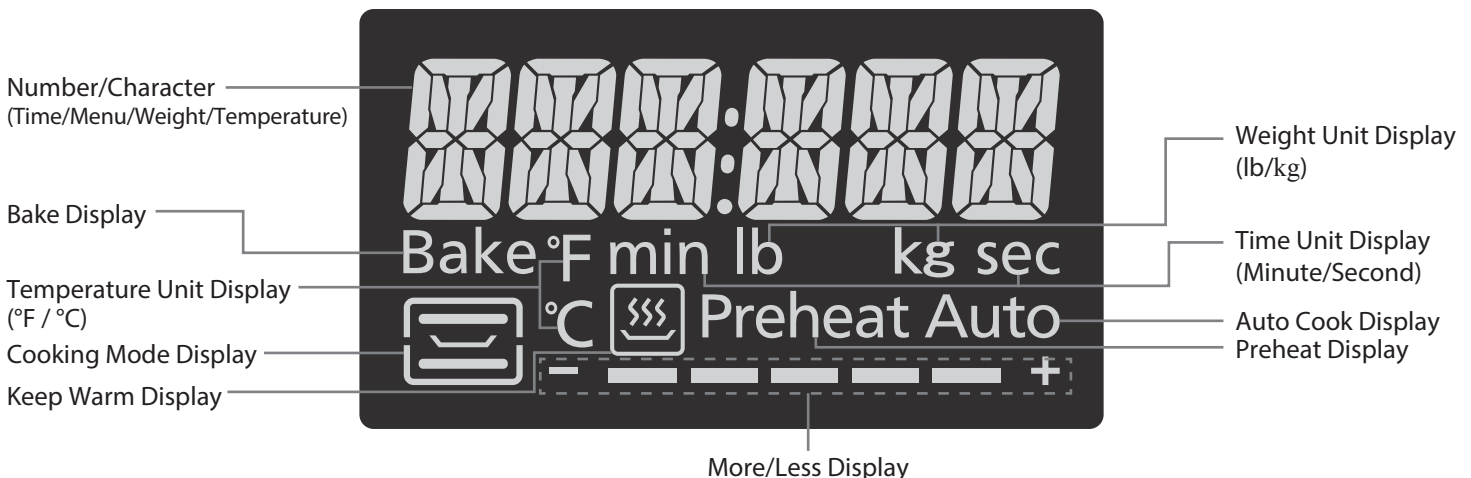

# Cook Mode

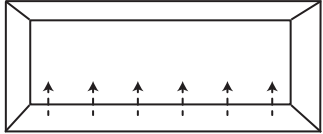
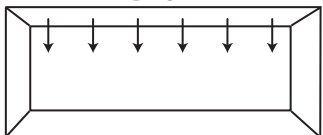
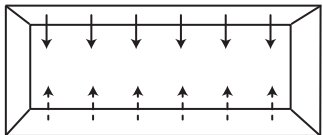
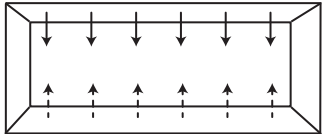
Cooking modes	Uses	Accessory to use	Containers
<p><b>Grill</b></p> 	<ul style="list-style-type: none"> <li>• <b>Grill</b> <ul style="list-style-type: none"> <li>■ Grill beef steak</li> <li>■ Grill lamb steak</li> <li>■ Grill pork steak</li> <li>■ Grill patties</li> </ul> </li> <li>• <b>Preheating is required.</b></li> <li>• <b>Keep Warm</b> <ul style="list-style-type: none"> <li>■ Keep warm cooked food.</li> </ul> </li> <li>• <b>No Preheating</b></li> </ul>	Grill pan.	See page 7.
<p><b>Broil</b></p> 	<ul style="list-style-type: none"> <li>■ Broil bacon.</li> <li>■ Melt cheese.</li> <li>• <b>No Preheating</b></li> </ul>		
<p><b>Combo</b></p> 	<ul style="list-style-type: none"> <li>■ Cook (GRILL+BROIL) poultry and meat.</li> <li>■ Cook (GRILL+BROIL) vegetables.</li> <li>■ Cook (GRILL+BROIL) seafood.</li> <li>• <b>Using Grill to preheat if desired.</b></li> </ul>		
<p><b>Bake</b></p> 	<ul style="list-style-type: none"> <li>■ Bake frozen snacks.</li> <li>■ Bake pie crusts.</li> <li>■ Bake muffins, cookies etc.</li> <li>• <b>Preheating is required and temperature can be selected.</b></li> </ul>		

————— : Broil elements heating  
 - - - - - : IH (Induction heating)

## IH (Induction Heating) Cooking Mechanism

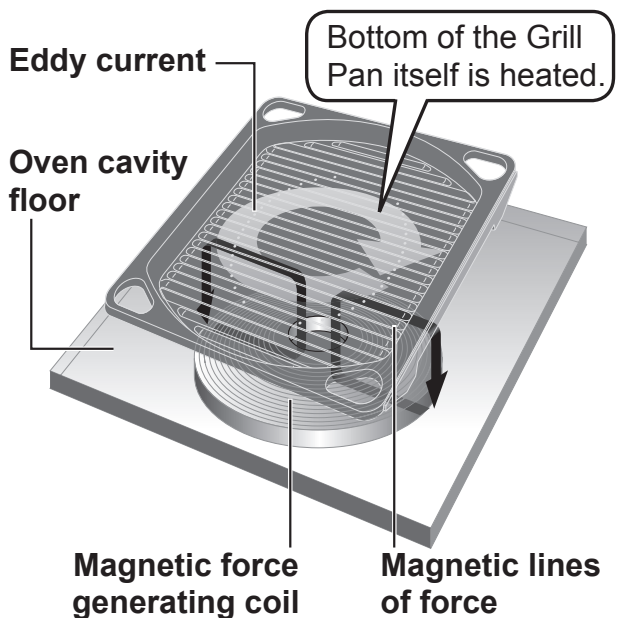

IH (Induction Heating) refers to electromagnetic induction heating. If electricity flows in the magnetic coils underneath the top plate, magnetic lines of force are produced. When the magnetic lines of force pass through the Grill Pan an eddy current is induced, and the heat generated by the electrical resistance of the Grill Pan is used for cooking.

# Operation

## Using the Oven for the First Time

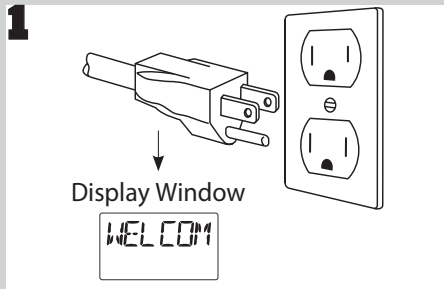

Plug into a properly grounded electrical outlet. "WELCOME TO PANASONIC REFER TO OWNER'S MANUAL BEFORE USE" scrolls across display window.



Press **Stop/Reset** Pad to confirm; a "0" will appear in the display window. Beep will sound.

## Setup Feature



This feature allows you to establish the initial non-cooking features of your oven. Press **Setup** Pad once.

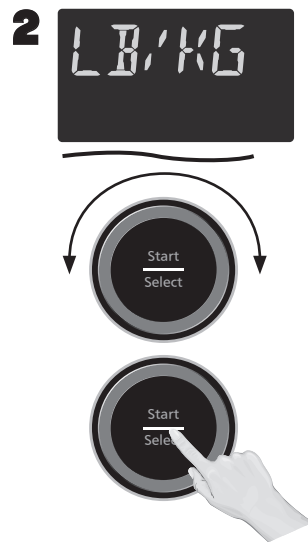

Rotate **Start/Select** Dial to select the desired feature. (LB/KG → TEMPERATURE → LANGUAGE → MENU ACTION ON/OFF → BEEP ON/OFF. See the chart on next page) This example shows WEIGHT CHOICE. Then press **Start/Select** Dial again to confirm.

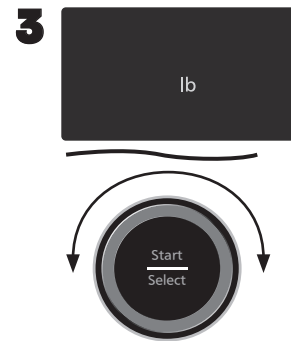

Rotate **Start/Select** Dial clockwise to select metric unit (kg). Rotate **Start/Select** Dial counterclockwise to select Imperial unit (lb).



Press **Start/Select** Dial, then repeat step 2-3 for additional selections.

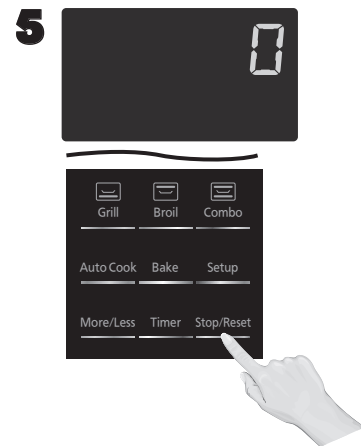

Press **Stop/Reset** Pad to exit; a "0" will appear in the display window.

**Continued on the Next Page**

## Operation (continued)

### Setup Feature (continued)

#### LB/KG CHOICE

The oven has both imperial and metric weight units. The oven displays the weight in imperial when you plug-in.

LB \* Rotate **Start/Select** Dial counterclockwise to select imperial unit (lb).

KG Rotate **Start/Select** Dial clockwise to select metric unit (kg).

#### TEMPERATURE CHOICE

The oven has both imperial and metric temperature units. The oven displays the temperature in imperial when you plug-in.

°F \* Rotate **Start/Select** Dial counterclockwise to select Imperial unit (°F).

°C Rotate **Start/Select** Dial clockwise to select metric unit (°C).

#### LANGUAGE CHOICE

The oven has a choice of English, French or Spanish display. The display appears in English when you plug-in. You can rotate **Start/Select** Dial to select the language choice.

ENGLISH \* Display appears in English.

FRANCAIS Display appears in French.

ESPANOL Display appears in Spanish.

#### MENU ACTION ON/OFF

MENU ACTION SCREEN helps you to program your oven by prompting the next step to be taken. When you become familiar with your oven, the prompt can be turned off. Prompting Guide appears in display window when you plug-in.

ON \* Rotate **Start/Select** Dial clockwise, prompting Guide will appear.

OFF Rotate **Start/Select** Dial counterclockwise, prompting Guide will not appear.

#### BEEP ON/OFF

If you wish to have the oven operate with no beep, it can be eliminated. Beep sound activates when you plug-in.

ON \* Rotate **Start/Select** Dial clockwise, beep sound will reactivate.

OFF Rotate **Start/Select** Dial counterclockwise, beep sound will not be heard.

\* DEFAULT MODE

## Operation (continued)

### Demo Mode



Press **Grill** Pad once, then Press **Start/Select** Dial 4 times, finally Press **Stop/Reset** Pad 4 times to turn ON/OFF the DEMO MODE feature. The oven automatically defaults to the DEMO MODE OFF.

#### NOTES:

1. When "DEMO MODE PRESS ANY KEY" appears in the display window, it means the oven is under demonstration mode, oven is not operational.
2. Demo mode is designed for retail store display. In this mode, the oven can be demonstrated with no power in the oven.

### Setting the Child Safety Lock

To set:



When "0" appears in the display, press **Start/Select** Dial 3 times; "LOCK" will appear in the display. Keypads may be pressed but the oven will not start.

To cancel:



Press **Stop/Reset** Pad 3 times; a "0" will appear in the display window.

#### NOTES:

1. This feature prevents the electronic operation of the oven until cancelled. It does not lock the oven door.
2. To set or cancel child safety lock, **Start/Select** Dial or **Stop/Reset** Pad must be pressed 3 times within 10 seconds.
3. You can set Child Lock feature when the display shows "0".



# Operation—Grill

## Grill Feature (with preheating)

Always put the Grill Pan on the oven cavity floor before preheating.



Press **Grill Pad** to select the Grill feature.



Rotate **Start/Select Dial** to select the desired Power Level.

Power level
HIGH
MED-HIGH
MEDIUM
MED-LOW
LOW
KEEP WARM

If you select the **Keep Warm**, this oven will not be preheated. (See next page for reference)



Press **Start/Select Dial** to preheat the oven. When preheating is completed, 3 beeps sound and "Preheat" icon will flash. Then open the oven door and place the food inside.



Rotate **Start/Select Dial** to set cooking time. Max cooking time is 60 min.



Press **Start/Select Dial**. Cooking begins and the time will count down. At the end of the cooking time, 5 beeps will sound.

## Guidelines for Grill

This feature is an IH (Induction heating) method.

IH (Induction heating) refers to electromagnetic induction heating. If electricity flows in the magnetic coils underneath the top plate, magnetic lines of force are produced. When the magnetic lines of force pass through the Grill Pan an eddy current is induced, and the heat generated by the electrical resistance of the Grill Pan is used for heating.

Grill feature is particularly useful for grilling meat.

When using Grill feature, please follow the guidelines below:

1. After cooking, please clean the oven when it cools down. See "Care and cleaning of your oven" on page 32.
2. After cooking, the accessories and surrounding oven will get very hot. **Use oven gloves.**
3. After pressing **Start/Select Dial**, the selected power can be recalled and changed. Press **Grill Pad** once to indicate the power in the display window. While the power is recalled in the display window, you can change the power (except Keep Warm) by rotating **Start/Select Dial**. Cooking time will display in the display window after 3 seconds, if you don't do any operation after changing the power.
4. When grilling meat, flipping is required during cooking. Please refer chart on page 26 - 30 for reference.
5. After cooking, verify food is done to your liking. Adjust time using Add Time feature. (See page 21)

### Special instructions

After using Grill function for cooking beef (steak, patty)/pork/lamb (including oily fat), clean the oven cavity completely every time. Operate the oven under Broil mode until smoke disappears, then wipe inside except ceiling after it cools down.

# Operation—Keep Warm

## Keep Warm Feature (without preheating)

Always put the Grill Pan on the oven cavity floor before cooking.



Press **Grill** Pad to select the Grill feature.

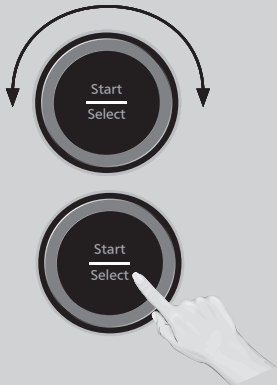
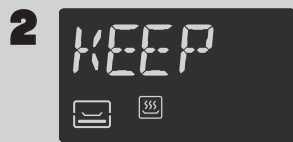

Rotate **Start/Select** Dial to select **Keep Warm**. Then press **Start/Select** Dial again to confirm.

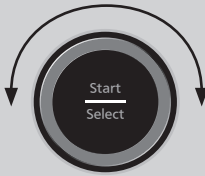

Rotate **Start/Select** Dial to set Keep Warm time. Max Keep Warm time is 60 min.

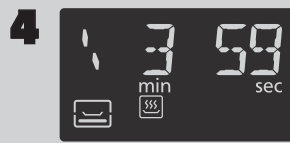

Press **Start/Select** Dial. Keep Warm begins and the time will count down. At the end of the cooking time, 5 beeps will sound.

## Guidelines for Keep Warm

This feature is used to keep warm cooked food. Don't cook raw food using this feature.

When using Keep Warm feature, please follow the guidelines below:

1. After cooking, please clean the oven when it cools down. See "Care and cleaning of your oven" on page 32.
2. After cooking, the accessories and surrounding oven will get very hot. **Use oven gloves.**
3. After finishing, you can add Keep Warm time using Add Time feature. (See page 21)

# Operation—Broil

## Broil Feature (without preheating)

Always put the Grill Pan on the oven cavity floor before cooking.



Press **Broil** Pad to select the Broil feature.

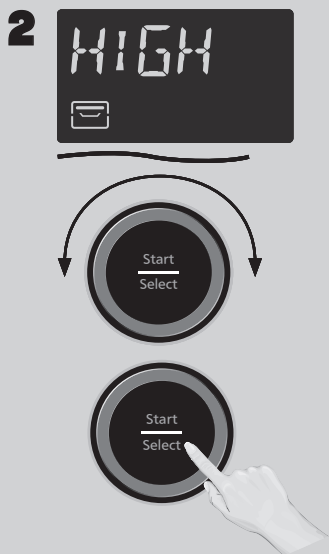

Rotate **Start/Select** Dial to select the desired Power Level. Then press **Start/Select** Dial again to confirm.

Power level
HIGH
MEDIUM
LOW

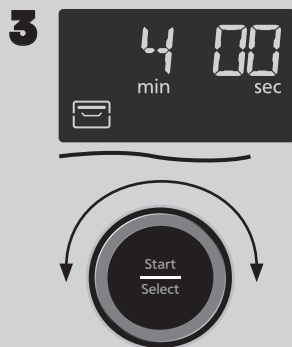

Rotate **Start/Select** Dial to set cooking time. Max cooking time is 60 min.



Press **Start/Select** Dial. Cooking begins and the time will count down. At the end of the cooking time, 5 beeps will sound.

## Guidelines for Broil

This feature is a heating method using the broiling elements.

When broiling, heat is radiated from the two elements at the ceiling of the oven. The broiling elements do not require preheating.

Broil feature is particularly useful for roasting bacon, melting cheese and browning gratin etc.

When using Broil feature, please follow the guidelines below:

1. After cooking, please clean the oven when it cools down. See "Care and cleaning of your oven" on page 32
2. After cooking, the accessories and surrounding oven will get very hot. **Use oven gloves.**
3. After cooking, verify food is done to your liking. Adjust time using Add Time feature. (See page 21)

# Operation—Combo

## Combo Feature (without preheating)

Always put the Grill Pan on the oven cavity floor before cooking.

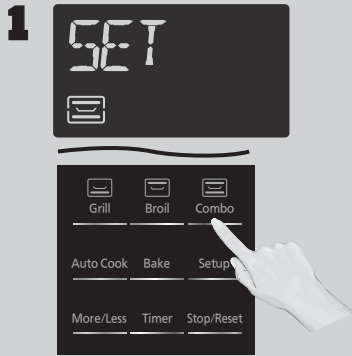

Press **Combo** Pad to select the Combo feature.

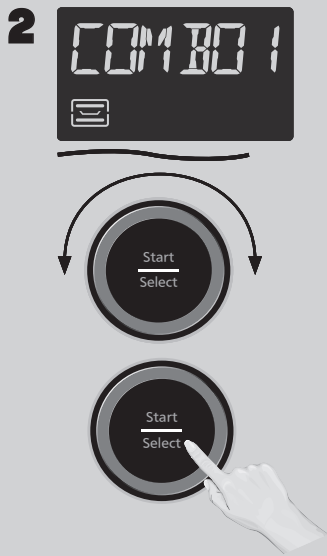

Rotate **Start/Select** Dial to select the desired Power Level. Then press **Start/Select** Dial again to confirm.

Power level	Useful cooking
COMBO 1	poultry, meat, pizza, toast
COMBO 2	vegetables
COMBO 3	seafood

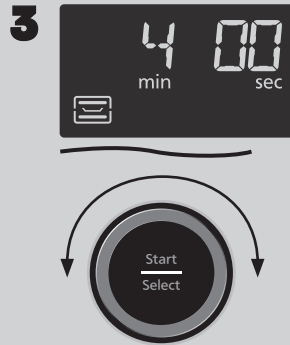

Rotate **Start/Select** Dial to set cooking time. Max cooking time is 60 min.



Press **Start/Select** Dial. Cooking begins and the time will count down. At the end of the cooking time, 5 beeps will sound.

## Guidelines for Combo

This feature combines broil and IH (Induction heating) methods.

Combo feature is particularly useful for cooking vegetables, seafood and poultry.

When using Combo feature, please follow the guidelines below:

1. After cooking, please clean the oven when it cools down. See "Care and cleaning of your oven" on page 32.
2. After cooking, the accessories and surrounding oven will get very hot. **Use oven gloves.**
3. After cooking, verify food is done to your liking. Adjust time using Add Time feature. (See page 21)

### Special instructions

After cooking vegetable, hot water will be on the oven cavity floor. Clean with a dry cloth, after it cools down.

# Operation—Combo (continued)

## Combo Feature (with preheating)

You can use Combo feature after oven preheated by Grill Feature. Always put the Grill Pan on the oven cavity floor before preheating.

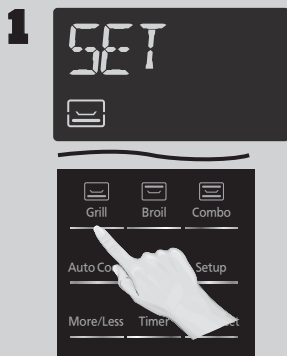

Press **Grill Pad** to select the preheat.



Rotate **Start/Select Dial** to select the preheat Power Level. (see page 15 for reference)



Press **Start/Select Dial** to preheat the oven. When preheating is completed, 3 beeps sound and "Preheat" icon will flash. Then open the oven door and place the food inside.



Press **Combo Pad** to select the Combo feature.

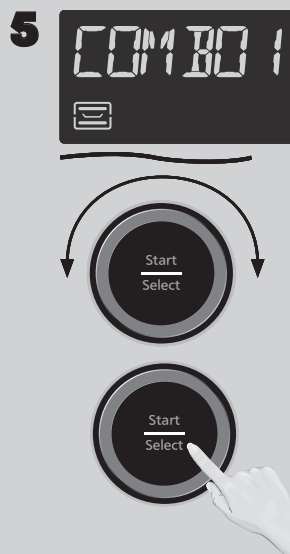

Rotate **Start/Select Dial** to select the desired Power Level. Then press **Start/Select Dial** again to confirm.

Power level	Useful cooking
COMBO 1	poultry, meat, pizza, toast
COMBO 2	vegetables
COMBO 3	seafood



Rotate **Start/Select Dial** to set cooking time. Max cooking time is 60 min.



Press **Start/Select Dial**. Cooking begins and the time will count down. At the end of the cooking time, 5 beeps will sound.

Please refer "Guidelines for Combo" on previous page, when operating.

# Operation—Bake

## Bake Feature (with preheating)

Always put the Grill Pan on the oven cavity floor before preheating.



Press **Bake** Pad to select the Bake feature.



Rotate **Start/Select** Dial to select the desired Temperature.

Temperature
325 °F
350 °F
375 °F
400 °F
425 °F
450 °F

For quick selection of the most commonly used temperatures, the temperatures start at 350 °F.



Press **Start/Select** Dial to preheat the oven. When preheating is completed, 3 beeps will sound and "Preheat" icon will flash. Then, open the oven door and place the food inside.



Rotate **Start/Select** Dial to set cooking time. Max cooking time is 60 min.



Press **Start/Select** Dial. Cooking begins and the time will count down. At the end of the cooking time, 5 beeps will sound.

## Guidelines for Bake

This feature is an adjusted combination of broiling heating and IH (Induction heating). Temperature can be selected in this mode.

Bake feature is particularly useful for baking cake and frozen food.

When using Bake feature, please follow the guidelines below:

1. After cooking, please clean the oven when it cools down. See "Care and cleaning of your oven" on page 32.
2. After cooking, the accessories and surrounding oven will get very hot. **Use oven gloves.**
3. After pressing **Start/Select** Dial, the selected temperature can be recalled and changed. Press **Bake** Pad once to indicate the temperature in the display window. While the temperature is recalled in the display window, you can change the temperature by rotating **Start/Select** Dial. Cooking time will display in the display window after 3 seconds, if you don't do any operation after changing the temperature.
4. For traditional cakes and pastry, with long cooking times, bake on Bake feature. It is recommended covering the food with aluminum foil for better baking results.
5. Reduce standard recipe temperature by 25-50 °F, when using Bake feature. Please refer chart on page 26 - 30 for the temperature and cooking time.
6. After cooking, verify food is done to your liking. Adjust time using Add Time feature. (See page 21)

# Operation—Timer / Add Time

## Setting the Timer



This feature allows you to program the oven as a kitchen timer. Press **Timer** Pad.



Rotate **Start/Select** Dial to set the desired amount of time (up to 60 minutes).



Press **Start/Select** Dial. Time will count down without oven operating.

**Caution:** If the oven light is lit while using the timer feature with the oven door closed, the oven is **NOT** set properly; **STOP OVEN IMMEDIATELY** and re-read instructions.

At the end of program, you can adjust time using Add Time feature. (See right side.)

## Adding Time



After manual cooking, this oven allows you to add cooking time at the end of previous cooking.

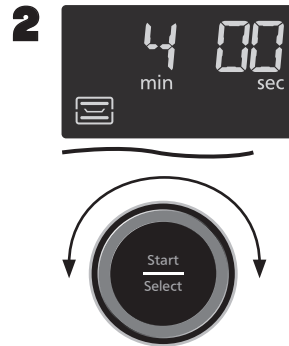

Rotate **Start/Select** Dial to set cooking time. Max added time is 30 min. This example shows the cooking after Combo 1.



Press **Start/Select** Dial. Cooking begins and the time will count down. At the end of the cooking time, 5 beeps will sound.

## NOTES:

1. Press **Stop/Reset** Pad to cancel Add Time feature.
2. The Add Time feature will be cancelled after 2 minutes, if you don't do any operation after cooking.

# Operation—Auto Cook

## Auto Cook (without preheating) (E.g. Set "1. Poultry with vegetables 0.5 lb")

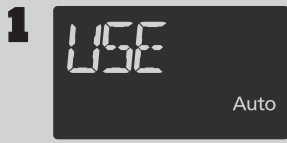

Press **Auto Cook** Pad to select the Auto Cook feature.

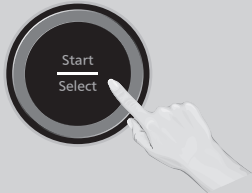

Rotate **Start/Select** Dial to select the desired menu (see the chart on next page). Press **Start/Select** Dial again to confirm.

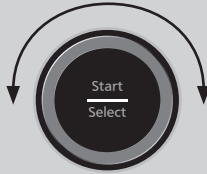

Rotate **Start/Select** Dial to select the desired weight.

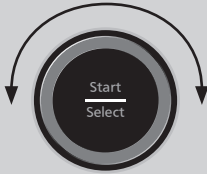
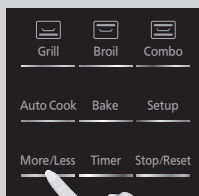

Press **More/Less** Pad to select more/less feature. Then rotate **Start/Select** Dial. (See below chart)

Original setting	- [---] +
More 1	- [---] +
More 2	- [---] +
Less 1	- [---] +
Less 2	- [---] +

See pages 23-25 for further information.

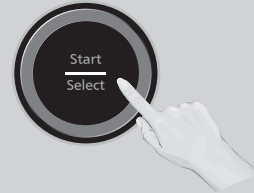

Press **Start/Select** Dial. Cooking begins and the time will count down. At the end of the cooking time, 5 beeps will sound.

### NOTES:

1. After cooking, please clean the oven when it cools down. See "Care and cleaning of your oven" on page 32.
2. When you select an automatic program symbols will appear in the display to show the cooking mode that will be used.
3. To allow for some variations that occur in food, check that food is thoroughly cooked and piping hot before serving.
4. After cooking, verify food is done to your liking. Adjust time using Add Time feature. (See page 21)



# Operation—Auto Cook (continued)

## Auto Cook Chart

See the chart below for Auto Cook categories.

Recipe	Serving/Weight				Accessory
	0.5 lb	1.0 lb	1.5 lb	2.0 lb	
<b>1. Poultry with vegetables</b>	0.5 lb	1.0 lb	1.5 lb	2.0 lb	Grill Pan
<b>2. Fish with vegetables</b>	0.5 lb	1.0 lb	-	-	
<b>3. Fish</b>	0.5 lb	1.0 lb	1.5 lb	-	
<b>4. Frozen pizza</b>	12" (17 - 20 oz.)	9" (13 - 14 oz.)	-	-	
<b>5. Toast</b>	2 slices	4 slices	-	-	
<b>6. Bagel</b>	2 halves	4 halves	-	-	

Operate as the following cooking method.

### 1. Poultry with vegetables

#### Ingredients:

Boneless chicken breast 1 inch thickness with skin	0.5 lb each (1/2/3/4 pieces)
Salt	1 tsp
Vegetables	total 1.2 lb
Red bell pepper	1
Zucchini	½
Potato	½
Onion	½
Mushroom	8
Olive oil	1 tbsp

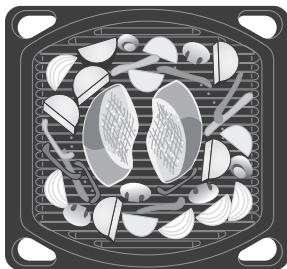

#### Method:

1. Making some cuts on the skinless side of the chicken breast will allow the seasoning to penetrate faster and deeper.
2. Cut red bell pepper into ¾ inch slices; cut zucchini into ¾ inch rounds; cut potato into 0.5 oz. pieces; cut onion into 1 inch pieces.
3. Season chicken breast with ½ tsp salt and season all the vegetables by olive oil and rest of salt for a few minutes. (just before cooking)
4. Place chicken breast on center of the Grill Pan with skin side upwards, then place all vegetables around the chicken breast. See the illustration on left side.
5. Put the Grill Pan on the Oven Cavity Floor, then select auto program and weight, press **Start/Select** Dial to cook. When cooking time is up, verify that chicken breast is done to your liking. Adjust time as needed.

#### Tips:

- \* The weight showed in the display window indicates the total weight of poultry.
- \* This program also can be used to cook poultry without skin.
- \* The amount of vegetables for all servings is the same.
- \* To get better result, always cut vegetables into sizes indicated above.
- \* For **boneless** chicken breast, the max thickness should be 1 inch.
- \* For thinner poultry pieces, such as chicken thigh, duck breast, please select "Less 1" or "Less 2".
- \* After cooking, always clean the oven when it fully cools down. See "Care and cleaning of your oven" on page 32.

#### Cooking by manual:

Prepare as above. Cook on Combo 1 for 22 to 26 minutes.

## Operation—Auto Cook (continued)

### 2. Fish with vegetables

#### Ingredients:

Boneless salmon 1 inch thickness with skin	1 piece (0.5 lb/1.0 lb)
Olive oil	2 tsp
Salt	1 tsp
Vegetables	total 1.2 lb
Red bell pepper	1
Zucchini	½
Potato	½
Onion	½
Mushroom	8
Olive oil	1 tbsp



#### Method:

1. Cut red bell pepper into ¾ inch slices; cut zucchini into ¾ inch rounds; cut potato into 0.5 oz. pieces; cut onion into 1 inch pieces.
2. Season salmon by ½ tsp salt and 2 tsp olive oil just before cooking.
3. Toss all the vegetables using the rest of salt and olive oil for a few minutes.
4. Place salmon on center of the Grill Pan with skin side down, then place all vegetables around. See the illustration on left side.
5. Put the Grill Pan on the Oven Cavity Floor, then select auto program and weight, press **Start/Select** Dial to cook. When cooking time is up, verify that salmon is done to your liking. Adjust time as needed.

#### Tips:

- \* The weight showed in the display window indicates the total weight of salmon.
- \* The amount of vegetables for all servings is the same.
- \* To get better result, always cut vegetables into bite size.
- \* For **boneless** salmon, the max thickness should be 1 inch.
- \* For thinner fish fillets, please select “Less 1” or “Less 2”.
- \* After cooking, always clean the oven when it fully cools down. See “Care and cleaning of your oven” on page 32.

#### Cooking by manual:

Prepare as above. Cook on Combo 3 for 20 to 24 minutes.

### 3. Fish

#### Ingredients:

Boneless salmon 1 inch thickness with skin	1 piece (0.5 lb/1 lb/1.5 lb)
Olive oil	2 tsp
Salt	½ tsp

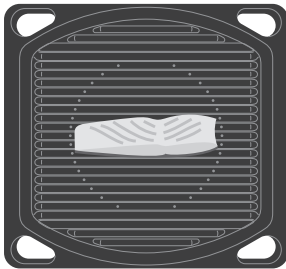

#### Method:

1. Season salmon by salt and olive oil just before cooking.
2. Place salmon on center of the Grill Pan with skin side down. See the illustration on left side.
3. Put the Grill Pan on the Oven Cavity Floor, then select auto program and weight, press **Start/Select** Dial to cook. When cooking time is up, verify that salmon is done to your liking. Adjust time as needed.

#### Tips:

- \* For **boneless** salmon, the max thickness should be 1 inch.
- \* For thinner fish fillets, please select “Less 1” or “Less 2”
- \* After cooking, always clean the oven when it fully cools down. See “Care and cleaning of your oven” on page 32.

#### Cooking by manual:

Prepare as above. Cook on Combo 3 for 24 to 26 minutes.

## Operation—Auto Cook (continued)

### 4. Frozen Pizza

#### Ingredients:

Frozen pizza (thin crust) 1 (12"/9")

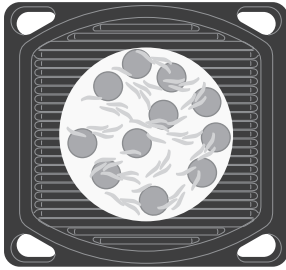

#### Method:

1. Put the frozen pizza on center of the Grill Pan. See the illustration on left side.
2. Put the Grill Pan on the Oven Cavity Floor, then select auto program and size, press **Start/Select** Dial to cook. When cooking time is up, verify that pizza is done to your liking. Adjust time as needed.

#### Tips:

- \* For thicker crust pizza, please select "More 1" or "More 2".
- \* The weight for 12" pizza should be 17 oz. to 20 oz., 9" should be 13 oz. to 14 oz.

#### Cooking by manual:

Prepare as above. Preheat on Bake to 400 °F, then cook for 6 to 10 minutes.

### 5. Toast

#### Ingredients:

White sliced bread 1 oz. each  
(2 slices/4 slices)

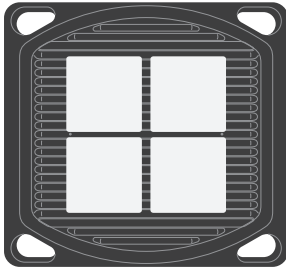
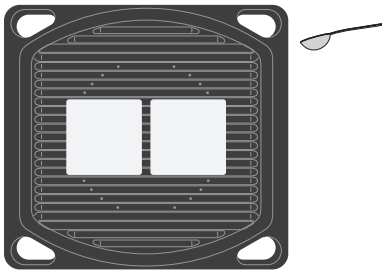

#### Method:

1. Put the bread on center of the Grill Pan, then pour 1 tsp water in each of the water pocket of the Grill Pan. See the illustration on left side.
2. Put the Grill Pan on the Oven Cavity Floor, then select auto program and servings, press **Start/Select** Dial to cook. When cooking time is up, verify that bread is done to your liking. Adjust time as needed.

#### Tips:

- \* Depending on the size, material, thickness, weight or brand of bread, the grill color is quite different. Select "More 1", "More 2", "Less 1" or "Less 2" as you like.

#### Cooking by manual:

Put the Grill Pan on the Oven Cavity Floor. Preheat on Grill Low. After preheating, place bread on the Grill Pan, pour 1 tsp water in each of the water pocket, cook on Combo 1 for 5 to 6 minutes.

### 6. Bagel

#### Ingredients:

Bagel 4 oz. each (2 halves/4 halves)

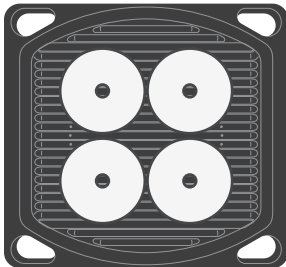
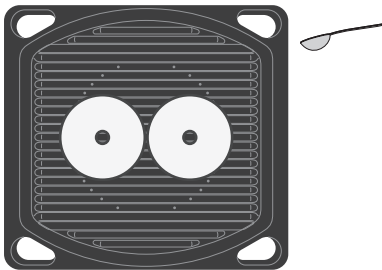

#### Method:

1. Cut the bagel into 2 halves.
2. Put the bagel on center of the Grill Pan with cut side upwards, then pour 1 tsp water in each of the water pocket of the Grill Pan. See the illustration on left side.
3. Put the Grill Pan on the Oven Cavity Floor, then select auto program and servings, press **Start/Select** Dial to cook. When cooking time is up, verify that the bagels are done to your liking. Adjust time as needed.

#### Tips:

- \* Depending on the size, material, thickness, weight or brand of bagel, the grill color is quite different. Select "More 1", "More 2", "Less 1" or "Less 2" as you like.

#### Cooking by manual:

Put the Grill Pan on the Oven Cavity Floor. Preheat on Grill Low. After preheating, place bagels on the Grill Pan, pour 1 tsp water in each of the water pocket, cook on Combo 1 for 7 to 8 minutes.

# Cooking Chart

Food	Weight/ Quantity	Function	Time to Select (approx)	Standing Time	Instructions/Guidelines
<b>Beef</b>					
Steak (1 inch)* - Rare - Medium -Well	0.9 - 1.0 lb	Grill MED-HIGH	4 - 5 min 6 - 7 min 8 - 9 min	5 min	For grilling a steak with a light char on surface and cooking the inside juicy, the starting temperature of the uncooked meat should be 60 °F. (standing at room temperature for 20 to 30 minutes is recommended.) After preheating, cook directly on the Grill Pan, flip at ½ of total time.
Steak (2 inch)* - Rare	1.3 - 1.7 lb	Grill MED-HIGH	11 - 12 min	5 min	For grilling a steak with a light char on surface and cooking the inside juicy, the starting temperature of the uncooked meat should be 60 °F. (standing at room temperature for 20 to 30 minutes is recommended.) After preheating, cook directly on the Grill Pan, flip after 6 minutes.
- Medium			14 - 15 min		For grilling a steak with a light char on surface and cooking the inside juicy, the starting temperature of the uncooked meat should be 60 °F. (standing at room temperature for 20 to 30 minutes is recommended.) After preheating, cook directly on the Grill Pan, flip after 7 minutes.
-Well			18 - 19 min		For grilling a steak with a light char on surface and cooking the inside juicy, the starting temperature of the uncooked meat should be 60 °F. (standing at room temperature for 20 to 30 minutes is recommended.) After preheating, cook directly on the Grill Pan, flip after 10 minutes.
Filet Mignon (1 inch)* - Medium	0.3 lb	Grill MED-HIGH	8 - 9 min	5 min	For grilling a filet mignon with a light char on surface and cooking the inside juicy, the starting temperature of the uncooked meat should be 60 °F. (standing at room temperature for 20 to 30 minutes is recommended.) After preheating, cook directly on the Grill Pan, flip after 3 minutes 30 seconds.
Tenderloin*	1.5 lb	Grill MEDIUM	23 - 24 min	5 min	For grilling a tenderloin with a light char on surface and cooking the inside juicy, the starting temperature of the uncooked meat should be 60 °F. (standing at room temperature for 20 to 30 minutes is recommended.) After preheating, cook directly on the Grill Pan, flip after 10 minutes.

### Special instructions

After using Grill function for cooking beef (steak, patty)/pork/lamb (including oily fat), clean the oven cavity completely every time. Operate the oven under Broil mode until smoke disappears, then wipe inside except ceiling after it cools down.

## Cooking Chart (continued)

Food	Weight/ Quantity	Function	Time to Select (approx)	Standing Time	Instructions/Guidelines
<b>Beef</b>					
Patties*	2 pcs (5 - 6 oz each) 4 pcs (5 - 6 oz each)	Grill MED-HIGH	6 - 7 min  7 - 7 min 30 s	-	For grilling patties with a light char on surface and cooking the inside juicy, the starting temperature of the uncooked meat should be 60 °F. (standing at room temperature for 20 to 30 minutes is recommended.) After preheating, cook directly on the Grill Pan, flip after 2 minutes.
Roast beef* - Medium	2.0 - 2.2 lb	Bake	450 °F 7 min then 350 °F 20 - 22 min	15 - 20 min	Start temperature should be at 50 °F. After preheating, cook directly on the Grill Pan.
Roast beef with vegetables* - Medium	2.0 - 2.2 lb	Bake	450 °F 5 min then 350 °F 20 - 22 min	20 - 30 min	Start temperature should be at 50 °F. After preheating, cook directly on the Grill Pan. After cooking, let it stand in the oven for 20 to 30 minutes.
<b>Pork</b>					
Bone-in - Chops (1 inch)	0.5 - 1.0 lb	Combo 1	20 - 24 min	-	Tenderize meat with a mallet before cooking. Cook directly on the Grill Pan.
Boneless*					
- Loin	1.6 - 1.8 lb	Grill MEDIUM	49 - 53 min	5 min	The max thickness should be 2 inches. After preheating, cook directly on the Grill Pan, flip after 17 minutes.
- Tenderloin	1.0 - 1.2 lb	Grill MEDIUM	23 - 25 min	5 min	The max thickness should be 1 inch. After preheating, cook directly on the Grill Pan, flip after 7 minutes.
- Ham (Ready-cooked)	12 - 13 oz	Grill MED-HIGH	2 min 30 s - 3 min	-	The max thickness should be ½ inch. After preheating, cook directly on the Grill Pan, flip after 1 minute.
- Sausages (precooked)	4 pcs (3 oz each)	Grill MED-HIGH	15 - 16 min	5 min	The max thickness should be 1½ inch. After preheating, cook directly on the Grill Pan, flip after 8 minutes.
- Sausages (raw)	4 pcs (4 oz each)	Grill MED-HIGH	12 - 13 min	5 min	The max thickness should be 1 inch. After preheating, cook directly on the Grill Pan, flip after 8 minutes.

### Special instructions

After using Grill function for cooking beef (steak, patty)/pork/lamb (including oily fat), clean the oven cavity completely every time. Operate the oven under Broil mode until smoke disappears, then wipe inside except ceiling after it cools down.

## Cooking Chart (continued)

Food	Weight/Quantity	Function	Time to Select (approx)	Standing Time	Instructions/Guidelines
<b>Lamb</b>					
Lamb steak Bone-in*	5.0 - 6.0 oz	Grill MED-HIGH	7 - 8 min	5 min	The max thickness should be 1 inch. After preheating, cook directly on the Grill Pan.
- Medium					
- Well	5.0 - 6.0 oz	Grill MED-HIGH	8 - 9 min		
Boneless*	1.2 - 1.3 lb	Bake	450 °F 5 min then 350 °F 13 - 14 min	10 min	Butterfly the lamb to cook evenly. After preheating, cook directly on the Grill Pan. After cooking, let lamb stand in oven.
- Medium					
- Well	1.2 - 1.3 lb		450 °F 5 min then 350 °F 18 - 19 min	20 min	
Chops (¾ inch), Shoulder*	0.4 - 0.5 lb	Grill MED-HIGH	5 - 6 min	2 min	After preheating, cook directly on the Grill Pan.
- Medium					
- Well	0.4 - 0.5 lb	Grill MED-HIGH	6 - 7 min		
<b>Vegetables</b>					
Onion	0.5 - 1.0 lb	Combo 2	12 - 16 min	-	Cut into round pieces, toss with salt, pepper and olive oil. Cook directly on the Grill Pan.
Mushroom	0.5 - 1.0 lb	Combo 2	15 - 17 min	-	Toss with salt, pepper and olive oil. Cook directly on the Grill Pan.
Asparagus	0.5 - 1.0 lb	Combo 2	12 - 17 min	-	Cut into 6-8 inch length, toss with salt, pepper and olive oil. Cook directly on the Grill Pan.
Zucchini	0.5 - 1.0 lb	Combo 2	14 - 17 min	-	Cut into 1 inch thickness bites, toss with salt, pepper and olive oil. Cook directly on the Grill Pan.
Carrots	0.5 - 1.0 lb	Combo 2	14 - 18 min	-	Cut into 1 inch thickness pieces, toss with salt, pepper and olive oil. Cook directly on the Grill Pan.
Green beans	0.5 - 1.0 lb	Combo 2	14 - 16 min	-	Toss with salt, pepper and olive oil. Cook directly on the Grill Pan.
Cabbage	0.5 - 1.0 lb	Combo 2	13 - 15 min	-	Cut into 2 inch pieces, toss with salt, pepper and olive oil. Cook directly on the Grill Pan.
Broccoli	0.5 - 1.0 lb	Combo 2	15 - 18 min	-	Poached before cooking, toss with salt, pepper and olive oil. Cook directly on the Grill Pan.

### Special instructions

1. After using Grill function for cooking beef (steak, patty)/pork/lamb (including oily fat), clean the oven cavity completely every time. Operate the oven under Broil mode until smoke disappears, then wipe inside except ceiling after it cools down.
2. After cooking vegetable, hot water will be on the oven cavity floor. Clean with a dry cloth, after it cools down.

## Cooking Chart (continued)

Food	Weight/ Quantity	Function	Time to Select (approx)	Standing Time	Instructions/Guidelines
<b>Seafood</b>					
Shrimp	0.5 - 1.0 lb	Combo 3	10 - 12 min	-	Toss with salt, pepper and olive oil. Cook directly on the Grill Pan.
Fish fillets 1 inch	0.5 - 1.0 lb	Combo 3	24 - 27 min	-	Toss with salt, pepper and olive oil. Cook directly on the Grill Pan.
Fish steaks - 1 inch - 1.5 inch	0.5 lb 0.8 - 1.0 lb	Combo 3	10 - 12 min 19 - 23 min	-	Toss with salt, pepper and olive oil. Cook directly on the Grill Pan.
Scallops	6 pcs (0.7 - 1.0 lb)	Combo 3	11 - 13 min	-	Toss with salt and pepper. Cook directly on the Grill Pan.
Oyster	8 pcs (1.0 lb)	Combo 3	16 - 17 min	-	Open shells. Cook directly on the Grill Pan.
<b>Poultry</b>					
Chicken breast	0.5 - 1.0 lb	Combo 1	21 - 23 min	-	Make cuts on the skinless side, marinate with salt and pepper. Cook directly on the Grill Pan.
Chicken pieces	0.5 - 1.0 lb	Combo 1	20 - 24 min	-	Pierce on the skin side with a fork. Cook directly on the Grill Pan.
Chicken wings	0.5 - 1.0 lb	Combo 1	18 - 20 min	-	Pierce several times with a fork. Cook directly on the Grill Pan.
Chicken thighs	0.5 - 1.0 lb	Combo 1	18 - 20 min	-	Pierce on the skin side with a fork. Cook directly on the Grill Pan.
Chicken drumstick	0.5 - 1.0 lb	Combo 1	24 - 27 min	-	Pierce several times with a fork. Cook directly on the Grill Pan.
Turkey - breast & tenderloin	6 - 12 oz	Combo 1	11 - 13 min	-	Rub with salt and pepper. Cook directly on the Grill Pan.
Duck - Breast	6 - 12 oz	Combo 1	15 - 17 min	-	Rub with salt and pepper. Cook directly on the Grill Pan.
<b>Frozen snacks</b>					
Chicken nuggets*	1.0 lb (½ oz each)	Bake 425 °F	12 - 13 min	-	After preheating, cook directly on the Grill Pan.
Hot pies etc* - 9" Apple pie - Frozen puff pastry turnover	2.0 lb 7 oz	Bake 325 °F	55 - 60 min 25 - 27 min	5 min	After preheating, put the pie pan directly on the Grill Pan. Cover with aluminum foil from 15 minutes.
Hot pockets*	1 - 2 pcs (5 oz each)	Bake 350 °F	22 - 23 min	-	After preheating, cook directly on the Grill Pan.
Frozen potato patties*	6 pcs (1 oz each)	Bake 450 °F	11 - 12 min	-	After preheating, cook directly on the Grill Pan.
Frozen Chicken wings*	0.5 - 0.6 lb	Bake 400 °F	19 - 20 min	-	After preheating, cook directly on the Grill Pan.
French fries*	0.5 - 1.0 lb	Bake 400 °F	17 - 23 min	-	After preheating, cook directly on the Grill Pan.
Preparing Pie crusts* - Homemade - Frozen - Graham cracker or cookie crust	12 - 13 oz 7 - 8 oz 9 - 10 oz	Bake 400 °F	22 - 23 min 10 - 11 min 7 - 8 min	-	Cover with aluminum foil before cooking. After preheating, cook directly on the Grill Pan.

## Cooking Chart (continued)

Food	Weight/ Quantity	Function	Time to Select (approx)	Standing Time	Instructions/Guidelines
<b>Prepared mix</b>					
Brownie mix*	8" x 8" (1.1 lb mix powder)	Bake 350 °F	30 - 32 min	-	Follow manufacturers' directions to prepare brownie. Cover with aluminum foil before cooking, pierce several holes on the foil. After preheating, put the cake mold directly on the Grill Pan.
Package cake mix (super moist)*	9" (1.2 lb mix powder)	Bake 350 °F	50 - 53 min	-	Follow manufacturers' directions to prepare packaged cake. Cover with aluminum foil before cooking, pierce several holes on the foil. After preheating, put the cake mold directly on the Grill Pan.
Refrigerated cookie dough*	7 pcs (1¼ oz each)	Bake 325 °F	14 - 15 min	-	After preheating, cook directly on the Grill Pan.
Package cookie*	9 pcs (1 oz each)	Bake 350 °F	10 - 11 min	-	After preheating, cook directly on the Grill Pan.
<b>Dessert</b>					
Muffins*	6 pcs (2 oz cake mixture each)	Bake 325 °F	17 - 19 min	-	Follow manufacturers' directions to prepare the muffins. After preheating, put the cake mold directly on the Grill Pan. Cover with foil after 12 minutes.
Quiche*	6" (10 oz)	Bake 350 °F	20 - 22 min	-	After preheating, put the mold directly on the Grill Pan. Cover with foil after 7 minutes.
	9" (2.0 lb)	Bake 325 °F	25 - 30 min	-	
Fresh pizza*	9" (20 oz)	Bake 450 °F	8 - 9 min	-	After preheating, cook directly on the Grill Pan.
	12" (2.0 lb)		9 - 10 min	-	
Chilled pizza*	12" (20 oz each)	Bake 400 °F	6 - 7 min	-	After preheating, cook directly on the Grill Pan.
Corn bread*	8" x 8" (27 oz mixture)	Bake 350 °F	30 - 33 min	-	Cover with aluminum foil, pierce several holes on the foil. After preheating, put the mold directly on the Grill Pan.
Casserole*	1.5 lb	Bake 350 °F	18 - 20 min	-	Using a 7" x 5½" x 2" dish. After preheating, put the container directly on the Grill Pan.
<b>Others</b>					
Bacon	2 slices 4 slices	Broil HIGH	9 - 10 min 14 - 15 min	-	Cook directly on the Grill Pan.
Cheese melt	2 pcs (0.6 - 0.7 oz)	Broil HIGH	3 min 30 s - 4 min	-	Put the cheese on bread. Cook directly on the Grill Pan.

**NOTES:**

1. Put the Grill Pan into oven when you cooking or preheating.
2. After cooking, please clean the oven when it fully cools down.
3. \* Preheat is necessary.



# Food Characteristics

## Food Characteristics

### Density

Porous, airy foods take less time to heat than heavy, dense foods



### Shape

Uniform sizes heat more evenly. To compensate for irregular shapes, place thick pieces toward the centre of the Grill Pan and thinner pieces toward the edge of the Grill Pan.

### Size

Thin pieces cook more quickly than thick pieces.



### Starting Temperature

Foods that are at room temperature take less time to cook than if they are chilled, refrigerated or frozen.



## Cooking Techniques

### Piercing

The skin or membranes on some foods will cause steam to build up during cooking. Foods must be pierced, scored or have the skin peeled off before cooking to allow steam to escape.

Pierce whole potatoes with a fork. Score frankfurters and sausages. Pierce fresh sausage with a fork.

### Browning

To shorten the baking or cooking time and to get a good color effect, apply dark soy sauce or spicy sauce before cooking. For quick breads or muffins, brown sugar can be used in the recipe in place of granulated sugar, or the surface can be sprinkled with dark spices before baking.

## Cooking Time

A range in heating time is given in each recipe. The time range compensates for the uncontrollable differences in food shapes, starting temperature and personal preferences. Always cook food for the minimum cooking time given in the recipe and check for doneness. If the food is under cooked, continue cooking. It is easy to add time to an under cooked product. Once the food is overcooked, nothing can be done!

## Test for Doneness

The same tests for doneness used in conventional cooking may be used. Meat is done when fork-tender or splits at fibers. Chicken is done when juices are clear yellow and drumstick moves freely. Fish is done when it flakes and is opaque. Cake is done when a toothpick or cake tester is inserted and comes out clean.

Check foods to see that they are cooked according to the United States Department of Agriculture's recommended temperatures.

To test for doneness, insert a meat thermometer in a thick or dense area away from fat or bone. NEVER leave the thermometer in the food during cooking, unless it is approved for oven use.

Cook all food to these minimum internal temperatures as measured with a food thermometer before removing food from oven. For reasons of personal preference, you may choose to cook food at higher temperatures.

Product	Minimum Internal Temperature & Rest Time
Beef, Pork, Veal & Lamb Steaks, chops, roasts	145 °F and allow to rest for at least 3 minutes
Ground meats	160 °F
Ham, fresh or smoked (uncooked)	145 °F and allow to rest for at least 3 min.
Fully Cooked Ham (to reheat)	Reheat cooked hams packaged in USDA-inspected plants to 140 °F ; all others to 165 °F.
All Poultry (breasts, whole bird, legs, thighs, and wings, ground poultry, and stuffing)	165 °F
Eggs	160 °F
Fish & Shellfish	145 °F
Leftovers	165 °F
Casseroles	165 °F

# Care and Cleaning of Your Oven

Please see below and the following page for particular cleaning instructions for each section of the oven.

**BEFORE CLEANING:** Unplug oven at the wall outlet.

- 1. Outside Oven Surfaces:** Clean with a damp cloth or paper towel. To prevent damage to the operating parts inside the oven, water should not be allowed to seep into ventilation openings.
- 2. Top of the Oven Cavity:** This area has a self-clean catalytic lining. It is therefore not necessary to clean it. It can be wiped off.
- 3. Inside the Oven:** Wipe with a damp cloth after using. Mild detergent may be used if needed. Do not use harsh detergents or abrasives. Spray cleaner on cloth.
- 4. Oven Door:** Wipe with a soft dry cloth when steam accumulates inside or around the outside of the oven door. During cooking, especially under high humidity conditions, steam is given off from the food. (Some steam will condense on cooler surfaces, such as the oven door. This is normal.) **Do Not remove the vapor barrier on the Oven door. Do not use harsh abrasive cleaners or sharp metal scrapers to clean the oven door glass** since they may scratch the surface, which may result in shattering of the glass.
- 5. Oven Cavity Floor:** Clean the bottom surface of the oven with mild detergent, water or window cleaner, and dry. Simply wipe the bottom surface of the oven with mild detergent and warm water then dry with a clean cloth. Cooking vapours collect during repeated use but in no way affect the bottom surface.
- 6. Control Panel:** The Control Panel is covered with a removable protective film to prevent scratches during shipping. Small bubbles may appear under this film, so if this is the case, remove by applying masking or clear tape to an exposed corner and pull gently. If the Control Panel becomes wet, clean it with a soft dry cloth. Do not use harsh detergents or abrasives. When cleaning the control panel, leave the oven door open to prevent the oven from accidentally turning on. After cleaning touch **Stop/Reset** Pad to clear the display window.
- 7. Grill Pan:** After cooking, put the Grill Pan into cool water immediately, pour mild detergent into it and soak it until the seasoning melts, then wipe with dishcloth. The remaining seasoning will damage to the fluorine coat on the surface of the Grill Pan if you don't clean it right now. Do not use abrasive cleaners to clean it. (Such as steel wool, etc.) Ensure the Grill Pan is kept clean, especially when using GRILL, COMBO, BAKE and AUTO COOK.
- 8. Air Vents:** Keep air vents clear at all times. Check that no dust or other material is blocking any of the air vents on the top, bottom or rear of the oven. If vents become blocked this could cause overheating which would affect the operation of the oven and possibly result in a hazardous situation.
- 9. Drip Tray:** Wash in warm soapy water. See page 8 for more information.

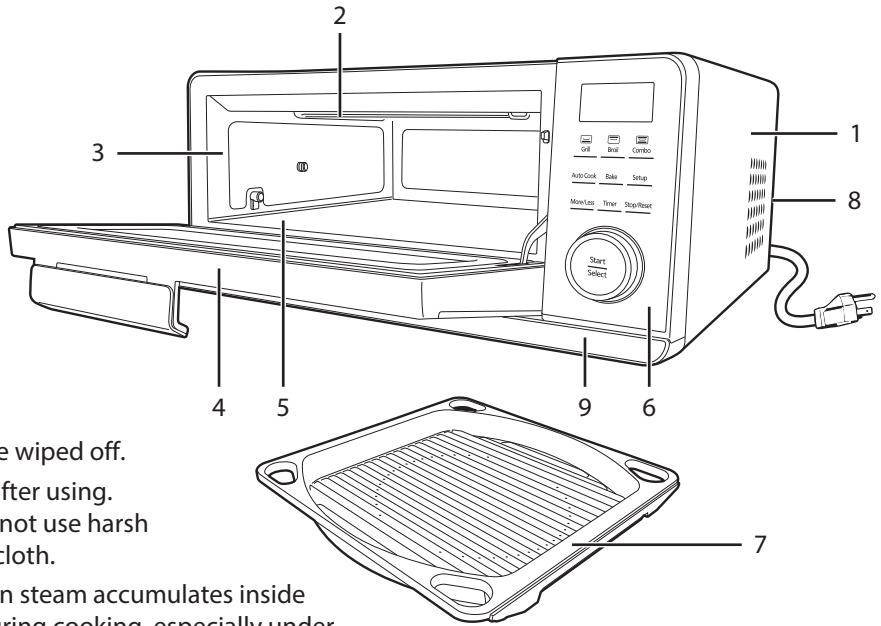

**AFTER CLEANING:** Plug unit in and be sure the oven is clean and dry, and press **Stop/Reset** Pad to clear the Display.

## NOTES:

- After using GRILL, BROIL, COMBO, BAKE and AUTO COOK cooking, the walls of the oven should be cleaned with a soft cloth or paper towel sprayed with a non-abrasive cleanser. Particular care should be taken to keep the window area clean especially after cooking by GRILL, BROIL, COMBO, BAKE and AUTO COOK. Stubborn spots inside the oven can be removed by using a small amount of branded conventional oven-cleaner sprayed onto a soft damp cloth. Wipe onto problem spots, leave for recommended time and then wipe off. **DO NOT SPRAY DIRECTLY INSIDE THE OVEN.**
- When cooking by GRILL, BROIL, COMBO, BAKE and AUTO COOK some foods may splatter grease onto the oven walls. If the oven is not cleaned to eliminate this grease, it can accumulate and cause the oven to 'SMOKE' during use. These marks will be more difficult to clean later. **There is no need to clean the catalytic lining at the top of the oven cavity.**
- Do Not use a steam cleaner for cleaning. Do Not spray conventional oven-cleaner directly inside the oven.**

## Tips:

When oven is dirty, add ½ cup (4 FL oz) water into the Grill Pan. Put the Grill Pan directly on the oven cavity floor. Preheat oven on 450 °F. After preheating, let oven fully cool down. Wipe with a damp cloth.

## Care and Cleaning of Your Oven (continued)

### Special instructions

1. After using Grill function for cooking beef (steak, patty)/pork/lamb (including oily fat), clean the oven cavity completely every time. Operate the oven under Broil mode until smoke disappears, then wipe inside except ceiling after it cools down.
2. After cooking vegetable, hot water will be on the oven cavity floor. Clean with a dry cloth, after it cools down.

**IT IS IMPORTANT TO KEEP THE OVEN CLEAN AND DRY. FOOD RESIDUE AND CONDENSATION MAY CAUSE RUSTING AND DAMAGE TO THE OVEN. AFTER USE, WIPE DRY ALL SURFACES, INCLUDING VENT OPENINGS, AND OVEN SEAMS.**

## Before Requesting Service

See below before calling for service, as most problems can easily be remedied by following these simple solutions:

Problem	Solution
The oven causes TV interference.	Some radio, TV, Wi-Fi, cordless telephone, baby monitor, blue tooth or other wireless equipment interference might occur when you cook with the oven. This interference is similar to the interference caused by small appliances such as mixers, vacuums, blow dryers, etc. It does not indicate a problem with your oven.
Steam accumulates on the oven door and warm air comes from the oven vents.	During cooking, steam and warm air are given off from the food. Most of the steam and warm air are removed from the oven by the air which circulates in the oven cavity. However, some steam will condense on cooler surfaces such as the oven door. This is normal. After use, the oven should be wiped dry (see page 32)
I accidentally operated my oven without any food in it.	Operating the oven empty for a short time will not damage the oven, however, it is not recommended.
There are humming and clicking noises from my oven when cooking.	These noise occur as the oven automatically switches the broil heater. This is normal.
The oven has an odour and generates smoke when using Bake, Broil Combo and Auto feature.	It is essential that your oven is wiped out regularly particularly after cooking Grill. Any fat and grease that builds up on the roof and walls of the oven will begin to smoke if not cleaned. The smoke will disappear after a few minutes. After using Grill function for cooking beef (steak, patty)/pork/lamb (including oily fat), clean the oven cavity completely every time. Operate the oven under Broil mode until smoke disappears, then wipe inside except ceiling after it cools down.
The fan motor continues operating after cooking is over	After using the oven, the fan motor will operate for several minutes to cool the electric components.
Some smoke is given off from the cavity when using Bake, Broil and Combo for the first time	This is caused by the excessive oil in the cavity and oil used for rust protection.
Oven will not turn on.	The oven is not plugged in securely or needs to be reset; remove plug from outlet, wait ten seconds and re-insert. Main circuit breaker or main fuse is tripped; reset main circuit breaker or replace main fuse. There is a problem with the outlet; plug another appliance into the outlet to check if it is working. The oven may be in stand-by mode; Ensure the oven is plugged in and open the door to activate.

## Before Requesting Service (continued)

Problem	Solution
Oven will not start cooking.	<p>The oven door is not completely closed; close the oven door securely.</p> <p><b>Start/Select</b> Dial was not pressed after programming; press <b>Start/Select</b> Dial.</p> <p>Another program is already entered into the oven; press <b>Stop/Reset</b> Pad to cancel the previous program and enter new program.</p> <p>The program is not correct; program again according to the Owner's Manual.</p> <p><b>Stop/Reset</b> Pad has been pressed accidentally; program oven again.</p>
The word " LOCK " appears in the display.	The CHILD SAFETY LOCK was activated by pressing <b>Start/Select</b> Dial 3 times; Deactivate CHILD SAFETY LOCK by pressing <b>Stop/Reset</b> Pad 3 times.
"DEMO MODE PRESS ANY KEY" or "D" appears in the display window.	Demo mode was selected "On"; Deactivate mode by pressing <b>Grill</b> Pad once <b>Start/Select</b> Dial 4 times and <b>Stop/Reset</b> Pad 4 times.

## Shop Accessories

Purchase Parts, Accessories and Instruction Books online for all Panasonic Products by visiting our Web Site at:  
**[shop.panasonic.com/support](http://shop.panasonic.com/support)**

**Parts Available to Order:**

Owner's Manual (this book) ..... F0003BV00AP  
 Grill Pan..... F443SBV00AP

# Limited Warranty (ONLY FOR U.S.A.)

## Panasonic Products Limited Warranty

### Limited Warranty Coverage (For USA Only)

If your product does not work properly because of a defect in materials or workmanship, Panasonic Consumer Electronics Company (referred to as "the warrantor") will, for the length of the period indicated on the chart below, which starts with the date of original purchase ("warranty period"), at its option either (a) repair your product with new or refurbished parts, (b) replace it with a new or a refurbished equivalent value product, or (c) refund your purchase price. The decision to repair, replace or refund will be made by the warrantor.

Product or Part Name	Labor	Parts
Small Appliances	1 yr.	1 yr.
Large Capacity Rice Cookers (SR-42 series)	6 Months	6 Months

During the "Labor" warranty period there will be no charge for labor. During the "Parts" warranty period, there will be no charge for parts.

This warranty only applies to products purchased and serviced in the United States. This warranty is extended only to the original purchaser of a new product which was not sold "as is".

### Mail-In Service – Online or Telephone Repair Request

#### Online Repair Request

To submit a new repair request, and for quick repair status visit our Web Site at: <http://shop.panasonic.com/support>

When shipping the unit, carefully pack and send it prepaid in the original (or supplied) carton. Include a letter detailing the complaint along with the bill of sales and provide a daytime phone number where you can be reached. A valid registered receipt is required under the Limited Warranty.

When shipping Lithium Ion batteries please visit our web site at <http://shop.panasonic.com/support> as Panasonic is committed to providing the most up to date information.

**IF REPAIR IS NEEDED DURING THE WARRANTY PERIOD, THE PURCHASER WILL BE REQUIRED TO FURNISH A SALES RECEIPT/PROOF OF PURCHASE INDICATING DATE OF PURCHASE, AMOUNT PAID AND PLACE OF PURCHASE. CUSTOMER WILL BE CHARGED FOR THE REPAIR OF ANY UNIT RECEIVED WITHOUT SUCH PROOF OF PURCHASE.**

#### Limited Warranty Limits And Exclusions

This warranty ONLY COVERS failures due to defects in materials or workmanship, and DOES NOT COVER glass, plastic parts, temperature probes (if included) and normal wear and tear or cosmetic damage. The warranty ALSO DOES NOT COVER damages which occurred in shipment, or failures which are caused by products not supplied by the warrantor, or failures which result from accidents, misuse, abuse, neglect, bug infestation, mishandling, misapplication, alteration, faulty installation, set-up adjustments, maladjustment of consumer controls, improper maintenance, power line surge, lightning damage, modification, or commercial use (such as in a hotel, office, restaurant, or other business), rental use of the product, service by anyone other than a factory service center or other authorized servicer, or damage that is attributable to acts of God.

**THERE ARE NO EXPRESS WARRANTIES EXCEPT AS LISTED UNDER "LIMITED WARRANTY COVERAGE".**

**THE WARRANTOR IS NOT LIABLE FOR INCIDENTAL OR CONSEQUENTIAL DAMAGES RESULTING FROM THE USE OF THIS PRODUCT, OR ARISING OUT OF ANY BREACH OF THIS WARRANTY.**

(As examples, this excludes damages for lost time, travel to and from the servicer, loss of or damage to media or images, data or other memory or recorded content. The items listed are not exclusive, but for illustration only.)

**ALL EXPRESS AND IMPLIED WARRANTIES, INCLUDING THE WARRANTY OF MERCHANTABILITY, ARE LIMITED TO THE PERIOD OF THE LIMITED WARRANTY.**

Some states do not allow the exclusion or limitation of incidental or consequential damages, or limitations on how long an implied warranty lasts, so the exclusions may not apply to you.

This warranty gives you specific legal rights and you may also have other rights which vary from state to state. If a problem with this product develops during or after the warranty period, you may contact your dealer or Service Center. If the problem is not handled to your satisfaction, then write to:

Consumer Affairs Department  
Panasonic Corporation of North America  
661 Independence Pkwy  
Chesapeake, VA 23320

**PARTS AND SERVICE, WHICH ARE NOT COVERED BY THIS LIMITED WARRANTY, ARE YOUR RESPONSIBILITY.**

## Shop Accessories!

for all your Panasonic gear

Go to

<http://shop.panasonic.com/support>

Get everything you need to get the most out of your Panasonic products  
Accessories & Parts for your Camera, Phone, A/V products, TV, Computers & Networking, Personal Care, Home Appliances, Headphones, Batteries, Backup Chargers & more...

### Customer Services Directory

For Product Information, Operating Assistance, Parts, Owner's Manuals, Dealer and Service info go to <http://shop.panasonic.com/support>

For the hearing or speech impaired TTY: 1-877-833-8855

As of Oct 2015

# Specifications

Power Source.....	120 V, 60 Hz
Power Consumption	
Grill .....	11.7 Amps, 1,400 W
Broil .....	10.7 Amps, 1,280 W
Combo.....	14.1 Amps, 1,710 W
Bake.....	14.1 Amps, 1,710 W
Outside Dimensions (W x H x D) .....	19 <sup>1</sup> / <sub>16</sub> " x 8 <sup>7</sup> / <sub>8</sub> " x 15 <sup>3</sup> / <sub>8</sub> " (500 mm x 225 mm x 390 mm)
Oven Cavity Dimensions (W x H x D).....	14 <sup>3</sup> / <sub>16</sub> " x 4 <sup>5</sup> / <sub>16</sub> " x 12 <sup>15</sup> / <sub>16</sub> " (360 mm x 110 mm x 328 mm)
Net Weight.....	Approx. 29.3 lbs (13.3 kg)

\*IEC Test procedure

Specifications subject to change without notice.

# User's Record

The serial number of this product may be found on the back side of the oven or on the left side of the control panel. You should note the model number and the serial number of this oven in the space provided and retain this book as a permanent record of your purchase for future reference.

Model No. \_\_\_\_\_

Serial No. \_\_\_\_\_

Date of Purchase \_\_\_\_\_

Panasonic Consumer Electronics Company,  
Division of Panasonic Corporation of North America  
Two Riverfront Plaza  
Newark, New Jersey 07102

Panasonic Appliances Microwave Oven (Shanghai) Co., Ltd.  
Website: <http://shop.panasonic.com/support>