

Dishwasher user manual

imagine the possibilities

Thank you for purchasing this Samsung product.
To receive more complete service,
please register your product at
www.samsung.com/global/register



features of your new samsung dishwasher

Your new Samsung Dishwasher will change the way you feel about doing dishes. From its extra large capacity to its energy efficiency, your new Samsung dishwasher has all the features to make your chores much less mundane.

1. Extra large capacity

The upper rack is slanted for larger dishes. The space has been maximized to accommodate a variety of dish sizes.

2. Elegant design with digital touch sensors

Digital touch sensors are used in the control panel for more simple operation, with a touch of elegance.

3. Increased convenience

The smart auto cycle determines the level of soil on the dishes and initiates the optimal cycle using this feature saving water, energy and time.

4. Extremely quiet operation

Efficient noise control technology is used for the quietest possible operation. Your new Samsung dishwasher will be quieter than ever.

5. Self-cleaning filter

Cleaning the filter yourself is a thing of the past! This product keeps food waste internally while operating, then drains it automatically with the water.











This manual contains important information regarding the use and care of your new Samsung dishwasher. Refer to it for descriptions of the control panel, instructions on how to use the dishwasher, and tips for making the most of its state-of-the-art features and technologies. The cycle chart on page 22 offers an overview of the different cycles and the troubleshooting section on page 23 tells you what to do if something goes wrong.

safety information

Throughout this manual, you'll see Warning ⚠ and Caution ⚠ notes. These important safety instructions do not cover all possible situations that might occur. It is your responsibility to use and caution when installing, maintaining, and operating your dishwasher. Samsung will not be liable for damages resulting from improper use.

IMPORTANT SAFETY INSTRUCTIONS

What the icons and signs in this user manual mean :

 WARNING	Hazards or unsafe practices that may result in severe personal injury or death .
 CAUTION	Hazards or unsafe practices that may result in personal injury or property damage .
 CAUTION	To reduce the risk of fire, explosion, electric shock, or personal injury when using your dishwasher, follow these basic safety precautions:
	Do NOT attempt.
	Do NOT disassemble.
	Do NOT touch.
	Follow directions explicitly.
	Unplug the power plug from the wall socket.
	Make sure the machine is grounded to prevent electric shock.
	Call the service center for help.

WARNING - When using the dishwasher, follow basic precautions, including the following:

-  Read all instructions before using the dishwasher.

As with any equipment using electricity, water and moving parts, potential hazards exist.

To safely operate this appliance, familiarize yourself with its operations and exercise care when using it.

Install and level your dishwasher on an uncarpeted floor that can support its weight.

Your dishwasher must be properly grounded. Never connect it to an ungrounded outlet. See page 11 for more information on grounding your dishwasher.

Connect the ground wire to the green ground connector in the terminal box.

Use the dishwasher only for its intended function.

SAVE THESE INSTRUCTIONS

safety information

Use only detergents or rinse agents recommended for use in a dishwasher, and keep them out of the reach of children.

After unpacking the dishwasher, keep the packaging out of the reach of children.

When loading items to be washed:

- Locate sharp items so that they are not likely to damage the door seal.
- Load sharp knives with the handles up to reduce the risk of cut-type injuries.



Do not wash plastic items unless they are marked “dishwasher safe” or the equivalent. For plastic items not so marked, check the manufacturer’s recommendations.



Do not touch the heating element during or immediately after use.

Do not operate the dishwasher unless all enclosure panels are properly in place.

Do not tamper with the controls.

Do not abuse, sit on, or stand on the door, lid, or dish racks of the dishwasher.

Do not push or place pressure on the door when it is open, as this may damage the dishwasher or cause harm.

To reduce the risk of injury, do not allow children to play in or on the dishwasher.

To reduce the risk of fire or explosion:

- Under certain conditions, hydrogen gas may be produced in a hot water system that has not been used for two weeks or more. **HYDROGEN GAS IS EXPLOSIVE.** If the hot water system has not been used for such a period, before using the dishwasher turn on all hot water faucets and let the water flow from each for several minutes. This will release any accumulated hydrogen gas. As the gas is flammable, do not smoke or use an open flame during this time.

Remove the door to the washing compartment when removing an old dishwasher from service or discarding it.



Disconnect the power cable (or disconnect the circuit breaker) before servicing your dishwasher.

Do not allow children to play in or on the dishwasher. They may harm themselves or damage the dishwasher.

Do not repair, replace, or service any part of your dishwasher yourself. Disassembly, repairs and modifications are permitted by authorized service technicians only. Work done by an unauthorized person may void your warranty.

Before disposing of your dishwasher, remove the door of the washing compartment or the door latch so that children or small animals do not get trapped inside.

SAVE THESE INSTRUCTIONS

The dishwasher is extremely heavy. Do not attempt to move or carry the dishwasher by yourself. Two or more people are needed to move a dishwasher and avoid potential injuries.

After the dishwasher is installed, check that the drain hose is properly connected and that there is no leakage from the hose connectors. If the drain hose is loose, it may cause property damage.

The water supply line is susceptible to breakage. As time goes by, it becomes less flexible. Check the line periodically. If it is swollen, torn, cut or there is a water leak, replace it immediately.

Do not put gasoline, solvents, or other flammable materials inside the dishwasher. Do not wash dishes exposed to these materials.

Keep your dishwasher detergent out of the reach of children. Detergent has an adverse effect on human organs. It contains elements for polishing and is corrosive. Avoid letting the detergent come into contact with your skin and eyes.

Do not install the dishwasher near electrical components. Keep the dishwasher away from open flames.

If the dishwasher is left unused for an extended period of time, turn off the water supply.

This dishwasher is intended for residential use only.

BEFORE USING YOUR DISHWASHER



WARNING



Tip-Over Hazard

- Do not use the dishwasher until it is correctly installed.
- Do not push down on an open door.
- Do not place excessive weight on the open door.



Electric Shock Hazard

Failure to follow these instructions can result in death, fire, or electric shock:

- Electrically ground the dishwasher
- Connect the ground wire to the green ground connector in the junction box.
- Do not use an extension cord.

SAVE THESE INSTRUCTIONS

contents

SETTING UP YOUR DISHWASHER

7

- 7 Unpacking your dishwasher
- 7 Checking parts
- 8 Control panel
- 10 Cycle selector
- 10 Display
- 11 Meeting installation requirements

USING YOUR DISHWASHER

12

- 12 Basic guidelines
- 14 Adjusting the angle of the plate supports
- 15 Adjusting the height of the upper rack
- 15 Removing the upper rack
- 16 Loading the lower rack
- 16 Loading the upper rack
- 17 Using the cutlery basket
- 18 Using the dispenser

CLEANING AND MAINTAINING YOUR DISHWASHER

20

- 20 Cleaning the exterior
- 20 Cleaning the interior
- 20 Cleaning the nozzles
- 21 Storing your dishwasher

CYCLES

22

- 22 Cycle chart

TROUBLESHOOTING

23

- 23 Check these points if your dishwasher...
- 25 Information codes

APPENDIX

26

- 26 Helping the environment
- 26 Specifications

setting up your dishwasher

Be sure to have your installer follow these instructions closely so that your new dishwasher works properly and that you're not at risk of injury when washing dishes.

UNPACKING YOUR DISHWASHER

- Once your new dishwasher has been delivered to you, carefully unpack it and check for any damage. If the dishwasher has been damaged, make note of it on the waybill and keep a copy. Do not install the dishwasher, and contact Samsung Customer Service at the number listed below.
- If there is no damage to the product, you can proceed with the installation. If you are going to install it yourself, make sure to read through the installation guide and follow the directions inside.
- After unpacking your dishwasher, keep the packaging out of the reach of children to ensure their safety.

CHECKING PARTS

When your dishwasher has been unpacked, make sure you've received all the parts shown below.

If your dishwasher was damaged during shipping, or if you do not have all the parts, contact **Samsung Customer Service at 1-800-SAMSUNG(726-7864)**

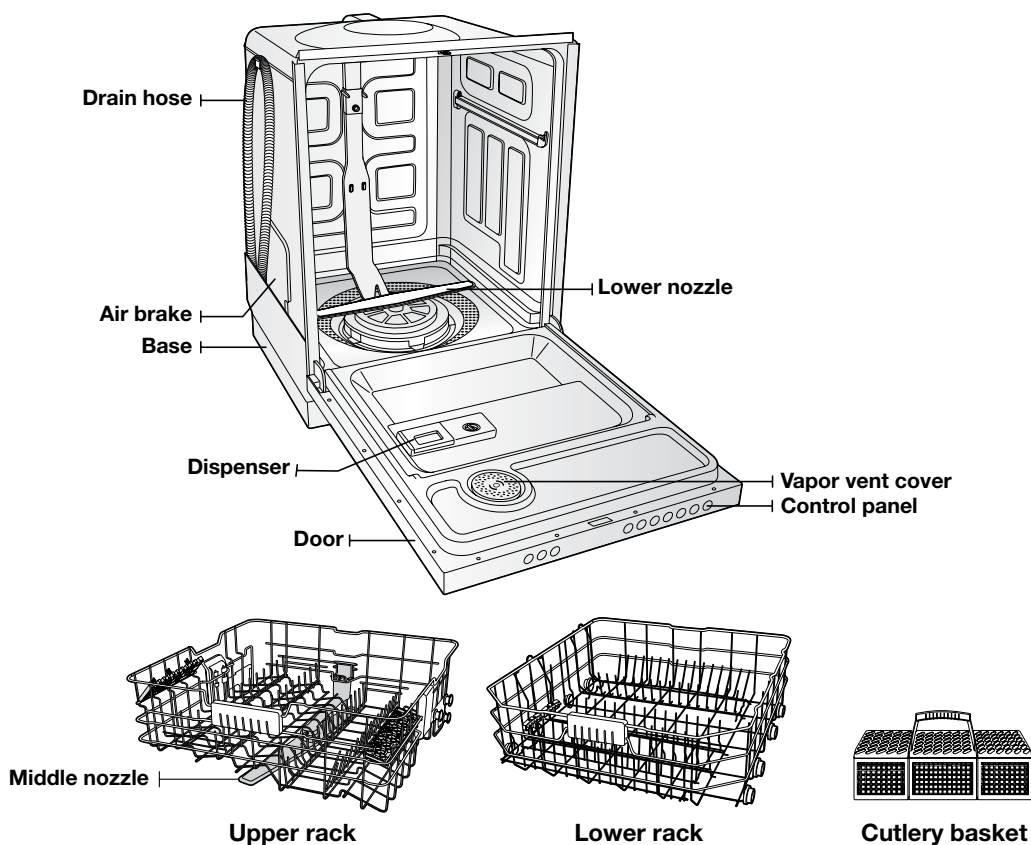



setting up your dishwasher

CONTROL PANEL

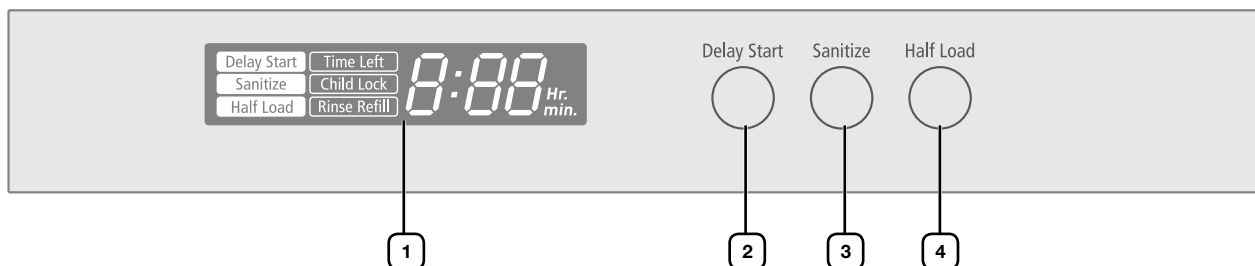
DMR77 Series



1 DISPLAY	<p>Displays the remaining wash time, any wash information (Delay start, Sanitize, Half load, Child lock), and error messages (Rinse refill, error). If an error occurs during an operation, an error message is displayed with a warning sound. Refer to the information codes page.</p>
2 DELAY START	<p>Delay a cycle for up to 24 hours in one-hour increments. The hour displayed indicates the time at which the wash will be started.</p>
3 SANITIZE	<p>The temperature rises to 162 °F (72 °C) in the final rinse cycle for high temperature sanitization. If you select the Sanitize option, the “Sanitize” indicator blinks when the water temperature meets the sanitary temperature (over 155 °F (68 °C)), and then illuminates for 10 minutes at the end of the cycle while it sanitizes.</p> <p> The Sanitize feature is in accordance with NSF/ANSI Standard 184 for Residential Dishwashers. Certified residential dishwashers are not intended for licensed food establishments. Your dishwasher is NSF Certified. The cycle that is NSF certified is the Heavy Cycle with the sanitize option selected.</p>
4 HALF LOAD	<p>Select this option to wash a small load of dishes. It is recommended that dishes are placed in the upper rack for this feature.</p> <p> When Half Load is selected, the dishes placed in the lower rack will not be washed. Only the dishes in the upper rack will be washed.</p> <p>If you select the Half Load option, both water and electricity consumption are reduced.</p>

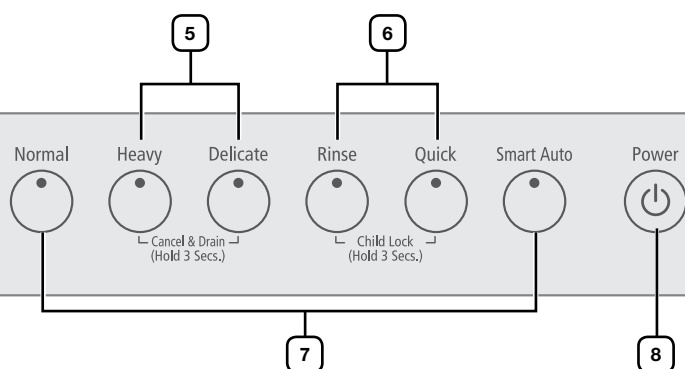

5 CANCEL & DRAIN	To cancel & drain a cycle currently running, hold down both the Heavy and Delicate buttons for three (3) seconds.
6 CHILD LOCK	<p>This option allows you to lock the buttons on the control panel. Children will not be able to accidentally start the dishwasher by pressing the buttons on the control panel when this option is selected. We recommend activating this feature while cleaning or wiping the control panel.</p> <p> When a cycle is running, you cannot operate the Power button. You can only operate it when no cycle is running.</p> <p>Activating/Deactivating - If you want to activate or deactivate this option, hold down the Rinse and Quick buttons simultaneously for three (3) seconds.</p>
7 CYCLE SELECTOR	You can select the appropriate wash cycle depending on the soil level of your dishes. When a cycle is selected, the indicator for that cycle lights up. If you want to cancel the selected cycle, press the selected cycle button again.
8 POWER	<p>When pressed, all indicator lights turn on and off and the most recently finished cycle light lights up.</p> <p>When the dishwasher is running and a selected cycle is finished, 'End' is displayed and the power turns off automatically.</p>

 You can select options (Half Load, Sanitize, or Delay Start) before starting a cycle. If you change the cycle after selecting an option, the original cycle is reset.

setting up your dishwasher

CYCLE SELECTOR

DMR77 Series

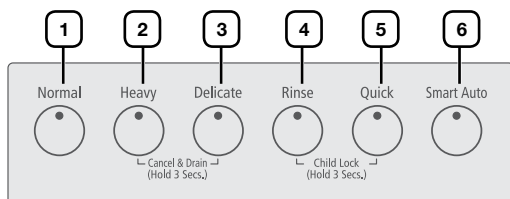

1	NORMAL	Use this cycle for regular dinner dishes.
2	HEAVY	Use this cycle for hard-to-clean, heavily soiled dishes, pots and pans, and dishes with heavy oil.
3	DELICATE	Use this cycle for normally soiled dishes or fragile items such as glasses.
4	RINSE	Use this cycle for pre-cleaned dishes or glasses. No detergent is dispensed and no dry cycle is initiated.
5	QUICK	Use this cycle for lightly soiled dishes. Detergent is dispensed but no dry cycle is initiated.
6	SMART AUTO	This cycle detects the level of soil and automatically initiates the optimal cycle after a few minutes of operation.

DISPLAY

DMR77 Series



Top



Front

1. When the door of the dishwasher is open, the top and front displays (PLURAL) are illuminated. When closed, only the front display is illuminated.
2. When Delay Start, Sanitize, Half Load, or Child Lock are selected, the respective indicators are illuminated.
3. When "Rinse Refill" remains illuminated there is no rinse agent in the dispenser and you should refill the rinse aid.
4. If the door is opened while a cycle is in progress, the remaining time will flash.

MEETING INSTALLATION REQUIREMENTS

Electrical supply and grounding



To prevent unnecessary risk of fire, electrical shock, or personal injury, all wiring and grounding must be done in accordance with the National Electrical Code ANSI/FNPA, No. 70 Latest Revision and local codes and ordinances. It is the personal responsibility of the appliance owner to provide adequate electrical service for this appliance.



Never use an extension cord.

When preparing for installation, ensure that your power supply offers:

- A 120 Volt 60 Hz 15 AMP fuse or circuit breaker
- An individual branch circuit serving only your dishwasher

Your dishwasher must be grounded. If your dishwasher malfunctions or breaks down, grounding will reduce the risk of electric shock by providing a path of least resistance for the electric current.



Never connect the ground wire to plastic plumbing lines, gas lines, or hot water pipes.

GROUNDING INSTRUCTIONS

For a permanently connected appliance:

This appliance must be connected to a grounded metal, permanent wiring system, or an equipment-grounding conductor must be run with the circuit conductors and then connected to the equipment-grounding terminal or lead on the appliance.

Water supply

Your dishwasher will fill properly when your water pressure is 20~120 psi (140~830 kPa). Water pressure less than 20 psi (140 kPa) may cause water supply valve failure, not allowing the water supply valve to shut off completely. Or, it may take the dishwasher longer to fill than what the controls allow, resulting in your dishwasher turning off. (A fill-time limit, designed to prevent overflowing/flooding if an internal line becomes loose, is built into the controls.)



Most plumbing supply stores sell water supply lines of various lengths up to 10 feet (305 cm) long.

You can reduce the risk of leaks and water damage by:

- Making water faucets easily accessible.
- Turning off faucets when the dishwasher is not in use.
- Periodically checking for leaks at water supply line fittings.



Before using your dishwasher for the first time, check all connections at the water supply valve and faucets for leaks.

Flooring

For best performance, your dishwasher must be installed on a solidly constructed floor. Never install your dishwasher on a platform or poorly supported structure.

Your dishwasher must be properly installed in accordance with the **Installation Guide** before it is used. If you did not receive an **Installation Guide** with your dishwasher, you can receive one by visiting our website at www.samsung.com.

using your dishwasher

BASIC GUIDELINES

1. Open the door and load your dishes (see page 16).
 - Place dishes into the upper and lower racks, unless half load is selected.
 - Remove any food remains from the dishes before placing them in the rack(s).
 - After placing the dishes into the racks, rotate the nozzles by hand to check whether any of the dishes will interfere with them.
2. Add detergent to the dispenser (page 18).
 - Make sure to use only automatic dishwasher detergent.
 - Refer to “Using the dispenser” on how to add detergent.
3. Press the **Power** button.
 - When the **Power** button is pressed, the entire display turns on and off and the most recently finished cycle light lights up.
 - If “Rinse Refill” is illuminated, you **should refill the rinse aid** to improve the washing and drying performance.
4. Select a cycle button (see pages 10 and 22).
 - Press the appropriate cycle button depending on the soil level of the dishes.
 - When a cycle is selected, the cycle light is illuminated. If the cycle button is activated again, the light turns off and the cycle is canceled.
 - On selecting a cycle according to the soil level of the dishes, see “Cycle Selector”.
5. Close the door.
 - Push the racks back so that they are in place. Close the door.
 - When the door is closed, the dishwasher will start the selected cycle after a few seconds.
 - The door must be firmly closed. If the door is slightly ajar, the selected cycle will not start automatically.
6. When the wash cycle is completed.
 - “End” is displayed on the display and a chime is played.
 - The power is automatically turned off.



CAUTION

When you want to load more dishes or pause the dishwasher while it is already running, make sure to open the door slowly and carefully as there is a possibility of injury from the hot steam inside the dishwasher.
(If the door is opened while the dishwasher is running, a safety mechanism is activated and stops the cycle.)



You should use rinse aids for better drying performance. You can further increase the drying performance by additionally selecting the Sanitize option and increasing the water temperature.

Touch controls

Allows you to easily operate the dishwasher.

- Convenient operations with a soft touch
- Simple and stylish design
- Easy to clean
- **If you have children or you want to clean the Control Interface, we recommend activating the Child-lock feature to lock the control buttons.**
 - Children will not be able to accidentally start the dishwasher by touching the controls with this option selected.
 - If cycle is running, buttons will not respond.
 - If dishwasher is off, only the **Power** button is responded

Condensing dry technology

- Saves energy by drying the dishes using the remaining heat after the last rinse cycle.
- Clean and safe. No hot steam is emitted during the drying cycle.



WARNING

Do not wash the following items

- **Acrylic, Aluminum:** Dishes with printed gold rim decoration may become discolored.
- **Dishes treated with adhesive:** Treated plastics, wood, ivory, copper and tin may come loose.
- **Plastics with a temperature tolerance less than 194 °F (90 °C) :** Thin plastics wash and dry poorly, and may be damaged due to elevated wash temperatures.
- **Tin:** Tin should be washed by hand and dried immediately as it may rust.
- **Wooden utensils:** Wooden items may crack.



WARNING

When using the dishwasher, try to arrange the dishes properly as described on page 16.

- You should remove food remains such as bones, fruit seeds, etc. and any other kind of waste such as toothpicks, paper, etc. from the dishes as these may cause damage to the dishes, create noise, or even a product malfunction.
- Select the appropriate cycle depending on the level of soil and the type of dishes.
- Use only the proper amount of detergent and rinsing agent.

using your dishwasher

ADJUSTING THE ANGLE OF THE PLATE SUPPORTS

The removable plate supports in the lower and upper racks allow you to adjust the angle of the tines up to five different levels according to the size and shape of the dishes. To adjust the angles, see the illustrations below.

In the lower rack, the plate support can be easily removed or can be folded to make room for large items such as pots and pans. In the upper rack, the plate support can also be removed.

Lift up the handles 'A' to remove the plate support. To refit the plate support, align it so it is in place and then push down the handles 'A'.

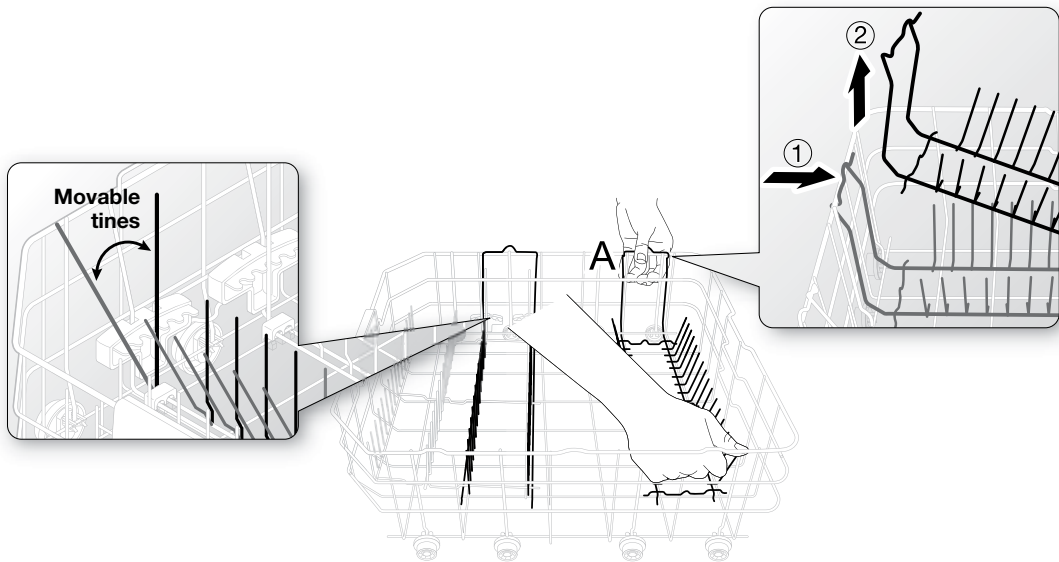

ADJUSTING THE HEIGHT OF THE UPPER RACK

This Samsung dishwasher uses a rack able to accommodate larger sized plates. By adjusting the height of the upper rack, you can make room for different size dishes. You can place dinner plates with a diameter of 14 in. (36 cm) into the lower rack and plates up to 12 in. (30 cm) in diameter into the upper rack.

DMR77 Series

1. To lower the upper rack by 2 in. (5 cm), press the 'A' levers located at the left and right sides of the upper rack and push the upper rack downwards slightly at the same time.
2. To raise the upper rack, just pull the upper rack upwards without operating any levers. The levers will latch and the upper rack will be in the high position.

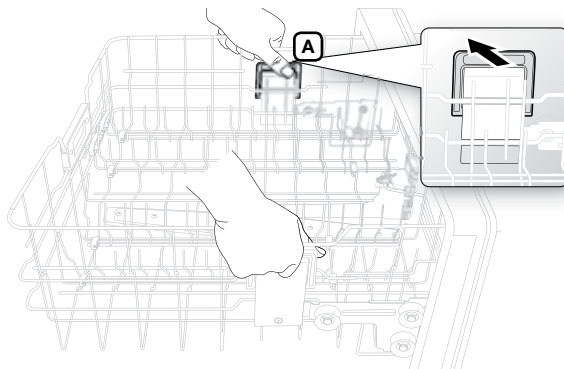

We recommend adjusting the height of the upper rack before loading dishes into the rack, as the dishes may be damaged.

REMOVING THE UPPER RACK

See the illustrations below for removing the upper rack.

Pull the upper rack towards the front and then remove it by lifting it up slightly and pulling it towards the front (as shown in figures below).

When loading dishes, we recommend pulling the upper rack sufficiently to the front and then loading it.



While the upper rack is removable, it must be installed for the dishwasher to operate properly. If you attempt to operate the dishwasher without the rack, noise will occur and the dishwasher will perform poorly.

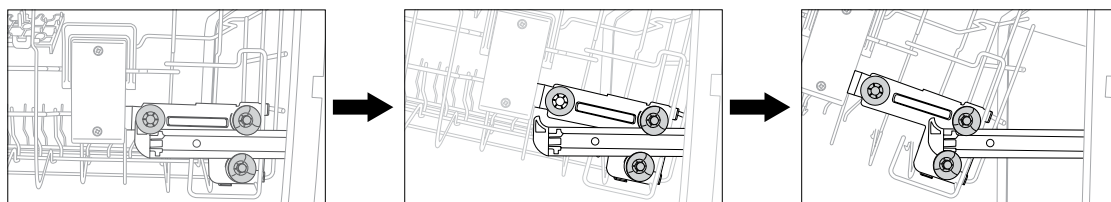

using your dishwasher

LOADING THE LOWER RACK

Load cookware (pots, pans, etc.), up to 14 in. (36 cm) in diameter into the lower rack. The lower rack has been especially designed for dinner dishes, soup bowls, plates, pots, lids, casserole dishes and plates.

Load your plates into the center column of the rack so their open sides face towards the right. Load large items such as pans and pots into the dishwasher so their open sides face downwards. We recommend loading cups, stemware and small plates into the upper rack.

See the recommended loading patterns below.

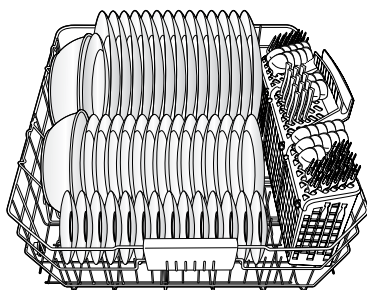

14 place setting

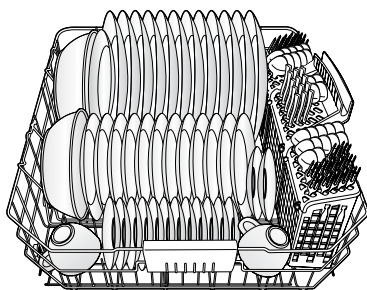

12 place setting

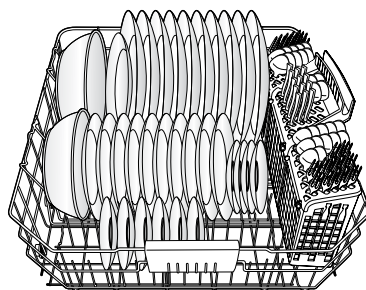

10 place setting

LOADING THE UPPER RACK

The upper rack has been designed for small plates, mugs, glasses and plastic items marked "dishwasher safe". Load your plates into the dishwasher so their open sides face forward. If a number of cups or cookware items need to be washed, you can adjust the angle of the movable tines or remove them to make more room.

Make sure the loaded dishes do not interfere with the rotation of the nozzle which is located at the bottom of the upper rack. (Check this by rotating the nozzle by hand.)

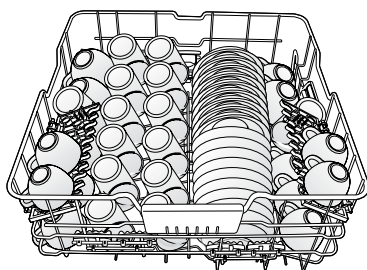

14 place setting

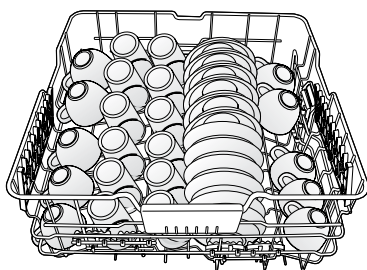

12 place setting

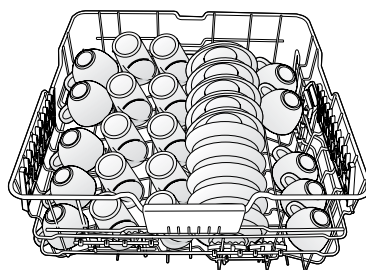

10 place setting

Using the glass support

You can load cups or glasses onto the glass support. This is also very convenient for washing wine glasses. Hang your wine glasses onto the pegs of the glass support.

You can fold the glass support back when it is not being used.

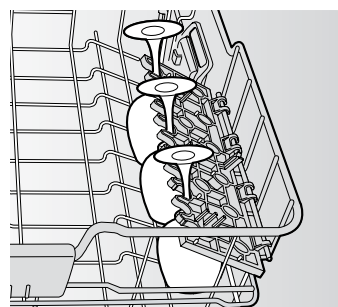

Loading the large items

You can load large items such as pans and pots into the lower rack.

Make sure pot handles and other items do not interfere with rotation of the nozzles.

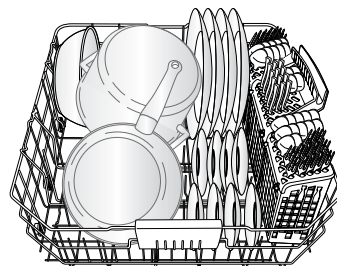

USING THE CUTLERY BASKET

The cutlery basket consists of three compartments. Each knife, spoon, or fork can be placed separately into the spoon stand to prevent chipping and discoloration.

 DO NOT let any item extend through the bottom.

- 1** Small forks
- 2** Spoons
- 3** Knives
- 4** Large spoons and forks
- 5** Medium-sized forks

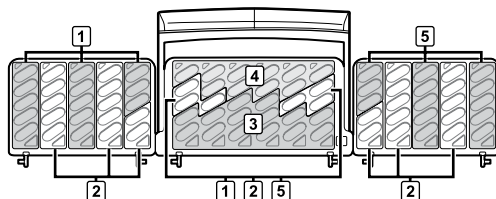
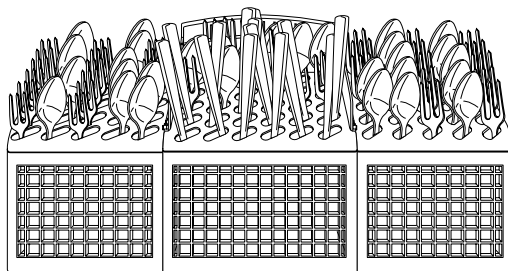

The cutlery basket can be used with the cover either open or removed. Refer to the illustration below to remove the cover. Take care not to break the plastic hinge.

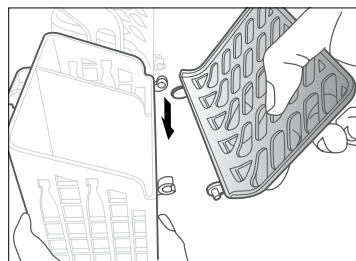
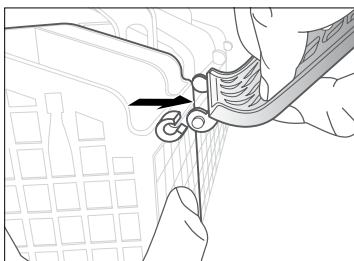
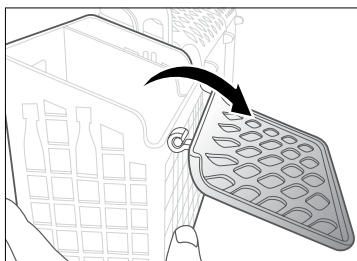

using your dishwasher

USING THE DISPENSER

Filling the detergent dispenser

1. Open the cover by pushing the cover latch downwards.

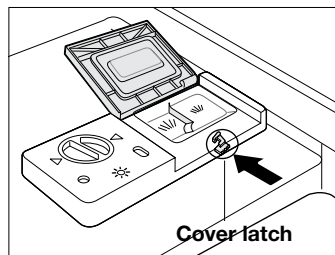

2. Add the recommended amount of detergent to the main wash dispenser using the table below.

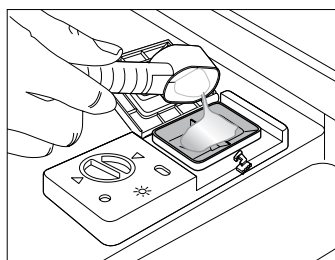

3. Close the dispenser cover. You will hear a 'click' when it is closed correctly.

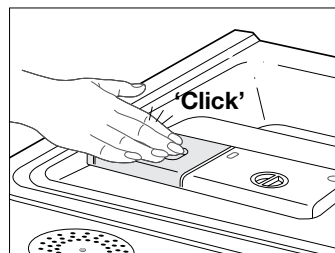

4. When Heavy cycle is selected, add the recommended amount of detergent to the pre-wash dispenser using the table below.

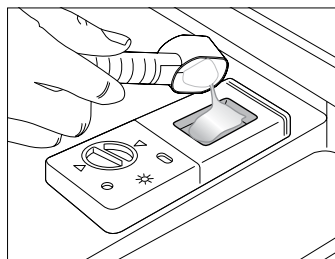

The cover opens automatically to dispense the detergent during the wash.

CYCLE	AMOUNT OF DETERGENT	
	Main wash dispenser	Pre-wash dispenser
Normal, Delicate, Quick, Smart Auto	0.5 oz (15 g)	No detergent
Heavy	0.7 oz (20 g)	0.2 oz (5 g)
Rinse	No detergent	No detergent

 The numbers inside the dispenser refer to grams.

Filling the rinse aid dispenser

Your dishwasher has been designed to use liquid rinse aid.

The use of a rinse aid greatly improves the drying performance after the final rinse.

1. Turn the dispenser knob counterclockwise to open the cover.

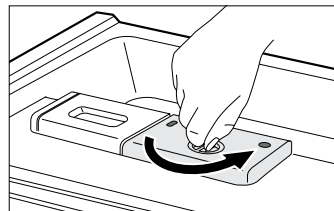

2. Pour rinse aid into the opening until the indicator points to "MAX." Avoid overfilling the dispenser.



3. Adjust the amount of rinse aid released during the rinse operation.

You can adjust the amount over four levels (1~4). The greater the number, the larger the amount of rinse aid released. The factory default is 3.

When the rinse dispenser is filled up, it is good for about 40 washes.

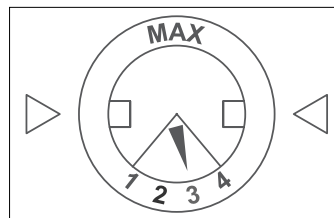

4. Close the cover.
Turn the dispenser knob clockwise.

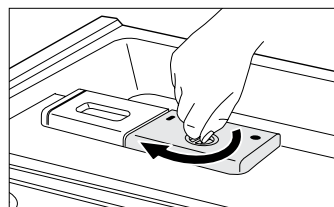

We strongly recommend using only liquid rinse aid.

cleaning and maintaining your dishwasher

Keeping your dishwasher clean improves its performance, reduces unnecessary repairs, and lengthens its life.

CLEANING THE EXTERIOR

It's best to clean spills on the outside of your dishwasher as they occur. Use a soft damp cloth on the control panel to gently wipe away spills and dust. Do not use benzene, wax, thinner, chlorine bleach, or alcohol. These materials may discolor the inner walls and may cause stains. Do not clean the dishwasher by sprinkling water over it and avoid water coming into contact with any of the electrical parts.

 If your dishwasher has a stainless steel door panel, it can be cleaned with a stainless steel cleaner for Home Appliances or similar product using a clean, soft cloth.

CLEANING THE INTERIOR

Clean the interior of your dishwasher periodically to remove any dirt or food particles. Wipe the inside of the dishwasher and the inner part of the door with a wet dishcloth. We recommend running the dishwasher periodically (using a Quick or Delicate cycle with the sanitize option) with an empty load after inserting dishwasher detergent. This will keep your dishwasher clean.

 Do not remove the Seal tub front (the long rubber seal enclosing the opening of the dishwasher).

CLEANING THE NOZZLES

If the cleaning performance of your dishwasher is continually low or the nozzles seem clogged, you can clean each of the nozzles. When removing the nozzles, take care as they may break.

Lower nozzle

1. Check whether the nozzle hole is clogged by food particles.
2. If cleaning is needed, remove the nozzle by pulling it upwards.
3. Clean the nozzle and push it back into place.
4. Check whether the nozzle is engaged correctly by rotating it by hand.

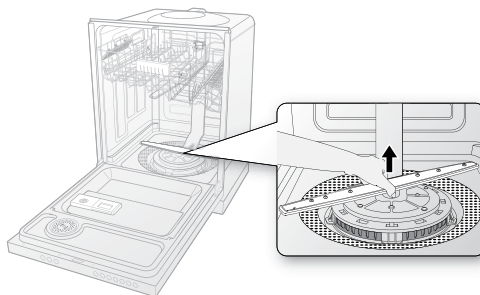

Middle nozzle

1. Pull the upper rack towards the front and remove it.
2. Check whether the nozzle hole is clogged by food particles.
3. If cleaning is needed, remove the nozzle.
4. To remove the nozzle, unfasten and remove the nut, and remove the nozzle.
5. Clean the nozzle, insert it again and fasten the nut.
6. When fastening the nut, rotate it firmly by hand.
7. Check whether the nozzle is engaged correctly by rotating it by hand.

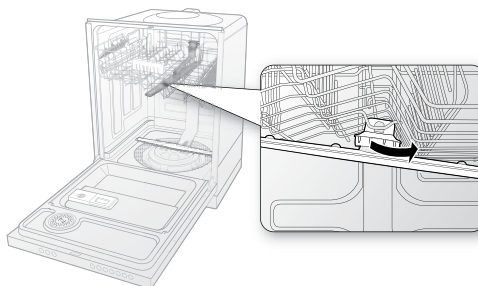

Upper nozzle

1. Check whether the nozzle hole is clogged by food particles.
2. If cleaning is needed, remove the nozzle.
3. To remove the nozzle, pull out the upper rack first, remove the duct connected to the nozzle from the tub bracket, and then remove the nozzle. To remove the bracket, use tools such as a screwdriver.
4. Clean the nozzle and connect it to the duct.
5. Insert the duct into the bracket.
6. Check whether the nozzle is engaged correctly by rotating it by hand.

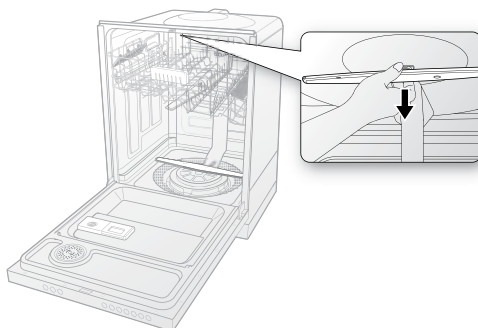

STORING YOUR DISHWASHER

If you need to store your dishwasher for an extended period of time, first drain and disconnect it, as your dishwasher may be damaged if water is left in the hoses and internal components before storage. After draining and disconnecting the dishwasher, be sure to turn off the water supply valve and circuit breaker.

cycles

CYCLE CHART

(●: Basic, ○: Flexible step)

Cycle	Pre-wash1	Pre-wash2	Pre-wash3	Main wash	Rinse1	Rinse2	Last Rinse [Sanitize]	Dry	Water [gal(ℓ)]	Time (min)
Normal	●	○		● 120 °F (49 °C)	●	○	● 140 °F (60 °C) [162 °F (72 °C)]	●	5.2-7.7 (19.6-29)	110-134
Heavy	●	●	●	● 149 °F (65 °C)	●	●	● 158 °F (70 °C) [162 °F (72 °C)]	●	9.0 (34)	182
Delicate	●			● 113 °F (45 °C)	●		● 140 °F (60 °C) [162 °F (72 °C)]	●	5.2 (19.6)	115
Rinse					●				1.3 (4.9)	11
Quick	●			● 113 °F (45 °C)	●		● 140 °F (60 °C) [162 °F (72 °C)]		5.2 (19.6)	38
Smart Auto	●	○	○	● 113 °F-149 °F (45-65 °C)	●	○	● 140-158 °F (60-70 °C) [162 °F (72 °C)]	●	5.2-9.0 (19.6-34)	58-182

- The numbers in parentheses in the Last Rinse column represent the temperature when Sanitize is selected. The wash time is the same.
- When Smart Auto or Normal cycle is selected, the ○ (flexible) steps can be eliminated depending on the level of soil of the dishes.
- The wash time varies depending on the added steps.
- Even though Half Load is selected, the cycle sequence remains the same.
- The wash time may vary depending on the water pressure, drain conditions, and temperature of the supplied water.

troubleshooting

CHECK THESE POINTS IF YOUR DISHWASHER...











PROBLEM	POSSIBLE CAUSE	SOLUTION
Will not start.	The door is not closed completely.	Check that the door is latched and closed completely.
	No cycle is selected.	Select a cycle.
	The power cable is not connected.	Connect the power cable.
	The water supply does not work.	Check that the water supply valve is open.
	A circuit is tripped or a fuse is open.	Reset the circuit breaker or replace the fuse.
Is taking too long with an operation (maybe cycle).	Cold water is being supplied.	Check that the water supply line is connected to a hot water supply. (Additional time is required to heat cold water.)
Has a bad odor.	There is water left over from the last cycle.	Insert detergent without loading dishes, and run the Quick cycle to clean the dishwasher.
Has water remaining after the cycle has finished.	The drain hose is folded or clogged.	Straighten the hose.
Has food particles remaining on dishes.	An inappropriate cycle has been selected.	Select a cycle according to the number and soil level of the dishes, as directed in this manual.
	The water temperature is low.	Connect the water supply line to a hot water supply.
	No dishwashing detergent is being used.	Use a automatic dishwasher detergent.
	The pressure of the supplied water is low.	The proper pressure of the supplied water should be 20~120 psi (140~830 kPa).
	A nozzle is clogged.	Clean the nozzle.
	The dishes are improperly loaded.	Rearrange the dishes so they do not interfere with the nozzle rotation and the dispenser operation.
Does not dry dishes well.	There is no rinse aid in the dispenser.	Check the dispenser and add rinse aid.
	The temperature of the water is low when the dishwasher is running.	Use rinse aid with the Sanitize option.

troubleshooting

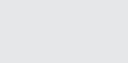
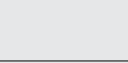
PROBLEM	POSSIBLE CAUSE	SOLUTION
Has spots and film left on dishes.	The water temperature is low.	For best performance, the temperature of the supplied water should be 120 °F (49 °C).
	The detergent amount is inappropriate.	Supply the appropriate amount of automatic dishwasher detergent.
	Too many dishes have been loaded.	Load only an appropriate number of dishes.
	Dishes are loaded incorrectly.	Load your dishes as recommended. (See page 16.)
	The pressure of the supplied water is insufficient.	The proper pressure of the supplied water is 20~120 psi (140~830 kPa).
	Improper detergent is being used.	Use a automatic dishwasher detergent.
	There is no rinse aid.	Check the dispenser and add the rinse aid.
	The water is too hard.	Add a water softener.
Is too noisy.	Sound is generated when the dispenser cover is open. Sound is generated when the drain pump is operating in an early stage.	This is normal operation.
	The dishwasher is not level.	Ensure the dishwasher is level.
	There is a 'chopping' sound because a nozzle is bumping against the dishes.	Rearrange the dishes.
Leaves glasses with a dim polish.	The supplied water is soft and too much detergent is being supplied.	Underload the dishwasher and use a rinse aid to minimize this.
Leaves black or gray marks on the dishes.	Aluminum dishes have been loaded.	Remove the marks on the dishes using a low sensitivity cleaner.
Leaves a yellow or brown film on the inside of the dishwasher.	This occurs from coffee and tea soils.	Remove the soils using a spot cleaner.
Does not have any lamps lit up.	The power is not connected.	Connect the power cable.
	The fuse is broken or the circuit breaker is out of order.	Replace the fuse or repair the circuit breaker.
Does not have a smoothly rotating nozzle.	The nozzle hole is clogged with food particles.	Clean the nozzle hole.
Has a bent upper rack after loading dishes.	The dishes are not loaded properly.	Load your dishes as recommended. (See page 16.)

INFORMATION CODES

Information codes are displayed to help you better understand what is occurring with your dishwasher.

CODE SYMBOL	MEANING	SOLUTION
	Thermistor error	Functional error. Disconnect the circuit breaker and contact a service center.
	Heater error	Functional error. Disconnect the circuit breaker and contact a service center.
	Heater error	Functional error. Disconnect the circuit breaker and contact a service center.
	Water supply error	Check whether the water supply line is connected correctly. Check whether the water supply valve is closed, the water supply is suspended or the water supply valve or line is frozen or clogged. If the problem continues, disconnect the circuit breaker and contact a service center.
	The temperature of the supplied water is too high	Check the temperature of the supplied water. If it is higher than 176 °F (80 °C), a functional error may occur with the dishwasher.
	Drain error	Check whether the drain hose is clogged or folded. If the problem continues, disconnect the circuit breaker and contact a service center.
	Water level error (over-level)	Functional error. Disconnect the circuit breaker and contact a service center.
	Low water level error	Functional error. Disconnect the circuit breaker and contact a service center.
	Leakage	Functional error. Close the water supply valve and disconnect the circuit breaker and contact a service center.
	Key pressed	Functional error. Disconnect the circuit breaker and contact a service center.
	Half load function error	Functional error. Disconnect the circuit breaker and contact a service center.

For any codes not listed above, call 1-800-SAMSUNG(726-7864)

appendix

HELPING THE ENVIRONMENT

- Your dishwasher is manufactured from recyclable materials. If you decide to dispose of it, please observe local waste disposal regulations. Cut off the power cable so that the appliance cannot be connected to a power source.
- Remove the door so that animals and small children cannot get trapped inside the appliance.
- Do not exceed the detergent quantities recommended in the detergent manufacturers' instructions.

SPECIFICATIONS

Model	DMR77LHS, DMR77LHB, DMR77LHW		
Type	Dishwasher	Wash capacity	14 place setting
Power	120 V/60 Hz AC only, 15 A circuit breaker	Wash temperature	Normal 120 °F (49 °C)
Wash type	Rotating nozzle spray	Rinse temperature	Normal 140 °F (60 °C)
Dry type	Condensed dry system	Standard amount of used water	Normal 7.7 gal (29 ℓ)
Used water pressure	20 ~ 120 psi (140 ~ 830 kPa)	Number of wash cycles	Standard 6 cycles
Dimensions (Width×Depth×Height)	Built-in	23.8 x 24.7 x 33.9 in. (605 x 627 x 860 mm)	
Rated power usage	Wash motor	170 W	
	Heater	1100 W	
Weight	Unpacked 115 lb (52 kg)		

warranty

SAMSUNG DISHWASHER

LIMITED WARRANTY TO ORIGINAL PURCHASER

This SAMSUNG brand product, as supplied and distributed by USA: SAMSUNG ELECTRONICS AMERICA, INC./CANADA: SAMSUNG ELECTRONICS CANADA, INC. (SAMSUNG) and delivered new, in the original carton to the original consumer purchaser, is warranted by SAMSUNG against manufacturing defects in materials and workmanship for a limited warranty period of:

One (1) Year All Parts and Labor, Five (5) Years Printed Circuit Board, Racking (Labor Charges for in-home service starting from the 2nd year is customer's responsibility), and Lifetime Stainless Door Liner & Tub for leakage. Samsung will replace your unit with same or current model (that is better or equivalent in functionality) (Labor related to replacement is customer's responsibility).

This limited warranty begins on the original date of purchase, and is valid only on products purchased and used in the United States/Canada. To receive warranty service, the purchaser must contact SAMSUNG for problem determination and service procedures. Warranty service can only be performed by a SAMSUNG authorized service center. The original dated bill of sale must be presented upon request as proof of purchase to SAMSUNG or SAMSUNG's authorized service center. SAMSUNG will provide in-home service during the warranty period at no charge, subject to availability within the contiguous United States/Canada. In home service is not available in all areas.

To receive in-home service, product must be unobstructed and accessible to the service agent. If service is not available, SAMSUNG may elect to provide transportation of the product to and from an authorized service center.

SAMSUNG will repair, replace, or refund this product at our option and at no charge as stipulated herein, with new or reconditioned parts or products if found to be defective during the limited warranty period specified above. All replaced parts and products become the property of SAMSUNG and must be returned to SAMSUNG. Replacement parts and products assume the remaining original warranty, or ninety (90) days, whichever is longer.

This limited warranty covers manufacturing defects in materials and workmanship encountered in normal, noncommercial use of this product and shall not apply to the following: damage that occurs in shipment; delivery and installation; applications and uses for which this product was not intended; altered product or serial numbers; cosmetic damage or exterior finish; accidents, abuse, neglect, fire, water, lightning, or other acts of nature or God; use of products, equipment, systems, utilities, services, parts, supplies, accessories, applications, installations, repairs, external wiring or connectors not supplied or authorized by SAMSUNG that damage this product or result in service problems; incorrect electrical line voltage, fluctuations and surges; customer adjustments and failure to follow operating instructions, maintenance and environmental instructions that are covered and prescribed in the instruction book; product removal and reinstallation; problems caused by pest infestations. This limited warranty does not cover problems resulting from incorrect electric current, voltage or supply, light bulbs, house fuses, house wiring, cost of a service call for instructions, or fixing installation errors. SAMSUNG does not warrant uninterrupted or error-free operation of the product.

warranty

EXCEPT AS SET FORTH HEREIN, THERE ARE NO WARRANTIES ON THIS PRODUCT EITHER EXPRESS OR IMPLIED, AND SAMSUNG DISCLAIMS ALL WARRANTIES INCLUDING, BUT NOT LIMITED TO, ANY IMPLIED WARRANTIES OF MERCHANTABILITY, INFRINGEMENT OR FITNESS FOR A PARTICULAR PURPOSE. NO WARRANTY OR GUARANTEE GIVEN BY ANY PERSON, FIRM, OR CORPORATION WITH RESPECT TO THIS PRODUCT SHALL BE BINDING ON SAMSUNG. SAMSUNG SHALL NOT BE LIABLE FOR LOSS OF REVENUE OR PROFITS, FAILURE TO REALIZE SAVINGS OR OTHER BENEFITS, OR ANY OTHER SPECIAL, INCIDENTAL OR CONSEQUENTIAL DAMAGES CAUSED BY THE USE, MISUSE, OR INABILITY TO USE THIS PRODUCT, REGARDLESS OF THE LEGAL THEORY ON WHICH THE CLAIM IS BASED, AND EVEN IF SAMSUNG HAS BEEN ADVISED OF THE POSSIBILITY OF SUCH DAMAGES.

NOR SHALL RECOVERY OF ANY KIND AGAINST SAMSUNG BE GREATER IN AMOUNT THAN THE PURCHASE PRICE OF THE PRODUCT SOLD BY SAMSUNG AND CAUSING THE ALLEGED DAMAGE.

WITHOUT LIMITING THE FOREGOING, PURCHASER ASSUMES ALL RISK AND LIABILITY FOR LOSS, DAMAGE, OR INJURY TO PURCHASER AND PURCHASER'S PROPERTY AND TO OTHERS AND THEIR PROPERTY ARISING OUT OF THE USE, MISUSE, OR INABILITY TO USE THIS PRODUCT. THIS LIMITED WARRANTY SHALL NOT EXTEND TO ANYONE OTHER THAN THE ORIGINAL PURCHASER OF THIS PRODUCT, IS NONTRANSFERABLE AND STATES YOUR EXCLUSIVE REMEDY.

Some states do not allow limitations on how long an implied warranty lasts, or the exclusion or limitation of incidental or consequential damages, so the above limitations or exclusions may not apply to you. This warranty gives you specific rights, and you may also have other rights, which vary from state to state.

To obtain warranty service, please contact SAMSUNG at:

In USA

SAMSUNG ELECTRONICS AMERICA, INC. – CONSUMER ELECTRONICS CUSTOMER SERVICE

400 Valley Road, Suite 201, Mt. Arlington, NJ 07856

1-800-SAMSUNG(726-7864)

www.samsung.com/us

In CANADA

SAMSUNG ELECTRONICS CANADA, INC. – CONSUMER ELECTRONICS CUSTOMER SERVICE

55 Standish Court, Mississauga, Ontario L5R 4B2 Canada

1-800-SAMSUNG(726-7864)

www.samsung.com/ca

memo



Questions or Comments?

Country	CALL	OR VISIT US ONLINE AT
USA	1-800-SAMSUNG(726-7864)	www.samsung.com/us
CANADA	1-800-SAMSUNG(726-7864)	www.samsung.com/ca

Code No. DD68-00018A_EN