

SAMSUNG

Instruction Manual

DVD-R155



www.samsung.com

AK68-01317A-01



Getting Started

Warning

TO REDUCE THE RISK OF ELECTRIC SHOCK, DO NOT REMOVE THE COVER(OR BACK). NO USER-SERVICEABLE PARTS ARE INSIDE. REFER SERVICING TO QUALIFIED SERVICE PERSONNEL.

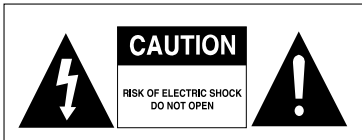

This symbol indicates that dangerous voltage consisting a risk of electric shock is present within this unit.



This symbol indicates that there are important operating and maintenance instructions in the literature accompanying this unit.

Do not install this equipment in a confined space such as a bookcase or similar unit.

WARNING : To prevent damage which may result in fire or electric shock hazard, do not expose this appliance to rain or moisture.

CAUTION : DVD RECORDERS USE AN INVISIBLE LASER BEAM WHICH CAN CAUSE HAZARDOUS RADIATION EXPOSURE IF DIRECTED. BE SURE TO OPERATE THE RECORDER CORRECTLY AS INSTRUCTED.

CAUTION

THIS PRODUCT UTILIZES A LASER. USE OF CONTROLS OR ADJUSTMENTS OR PERFORMANCE OF PROCEDURES OTHER THAN THOSE SPECIFIED HEREIN MAY RESULT IN HAZARDOUS RADIATION EXPOSURE. DO NOT OPEN COVERS AND DO NOT REPAIR YOURSELF. REFER SERVICING TO QUALIFIED PERSONNEL.

CAUTIONS

Caution: To prevent electric shock, match wide blade of plug to wide slot, fully insert.

Attention: Pour éviter les chocs électriques, introduire la lame la plus large de la fiche dans la borne correspondante de la prise et pousser jusqu'au fond.

This product satisfies FCC regulations when shielded cables and connectors are used to connect the unit to other equipment. To prevent electromagnetic interference with electric appliances, such as radios and televisions, use shielded cables and connectors for connections.

FCC NOTE (for U.S.A):

This equipment has been tested and found to comply with the limits for a Class B digital device, pursuant to Part 15 of the FCC Rules. These limits are designed to provide reasonable protection against harmful interference in a residential installation.

This equipment generates, uses and can radiate radio frequency energy and, if not installed and used in accordance with the instructions, may cause harmful interference to radio communications. However, there is no guarantee that interference will not occur in a particular installation.

If this equipment does cause harmful interference to radio or television reception, which can be determined by turning the equipment off and on, the user is encouraged to try to correct the interference by one or more of the following measures:

- Reposition or relocate the receiving antenna.
- Increase the separation between the equipment and receiver.
- Connect the equipment into an outlet on a circuit different from that to which the receiver is connected.
- Consult the dealer or an experienced radio/TV technician for help.

Caution: FCC regulations state that any unauthorized changes or modifications to this equipment may void the user's authority to operate it.



- This unit can be used only where the power supply is AC 120V, 60Hz. It cannot be used elsewhere.
- This DVD Recorder is designed and manufactured to respond to the Region Management Information. If the Region number of a DVD disc does not correspond to the Region number of this DVD Recorder, the DVD Recorder cannot play the disc.
- This device is protected by U.S. Patent Nos. 4,631,603; 4,577,216; 4,819,098; 4,907,093; and 6,516,132. This product incorporates copyright protection technology that is protected by U.S. patents and other intellectual property rights. Use of this copyright protection technology must be authorized by Macrovision, and is intended for home and other limited viewing uses only unless otherwise authorized by Macrovision. Reverse engineering or disassembly is prohibited.
- This product is covered by one or more of the following U.S. patents:
5,060,220 5,457,669 5,561,649 5,705,762 5,987,417
6,043,912 6,222,983 6,272,096 6,377,524 6,377,531
6,385,587 6,389,570 6,408,408 6,466,532 6,473,736
6,477,501 6,480,829 6,556,520 6,556,521 6,556,522
6,578,163 6,594,208 6,631,110 6,658,588 6,674,697
6,674,957 6,687,455 6,697,307 6,707,985 6,721,243
6,721,493 6,728,474 6,741,535 6,744,713 6,744,972
6,765,853 6,765,853 6,771,890 6,771,891 6,775,465
6,778,755 6,788,629 6,788,630 6,795,637 6,810,201
6,862,256 6,868,054 6,894,963 6,937,552

| | |
|-----------|--|
| DANGER | - VISIBLE AND INVISIBLE LASER RADIATION WHEN OPEN. AVOID DIRECT EXPOSURE TO BEAM. |
| CAUTION | - VISIBLE AND INVISIBLE LASER RADIATION WHEN OPEN. AVOID EXPOSURE TO BEAM. |
| ATTENTION | - RAYONNEMENT LASER VISIBLE ET INVISIBLE EN CAS D'OUVERTURE. EXPOSITION DANGEREUSE AU FAISCEAU. |
| ADVARSEL | - SYNLIG OG USYNLIG LASERSTRÅLING VED ÅBNING. UNDGÅ UDSÆTTELSE FOR STRÅLING. |
| VARO! | - AVATTAESSA OLET ALTIHINA NÄKYVÄÄ JA NÄKYMÄTÖN LASERSÄTEILYLLÄ. ÄLÄ KATSO SÄTEESEEN. |
| VARNING | - SYNLIG OCH OSYNLIG LASERSTRÅLNING NÄR DENNA DEL ÄR ÖPPNAD. BETRAKTA EJ STRÅLEN. |
| ADVARSEL | - SYNLIG OG USYNLIG LASERSTRÅLING NÄR DEKSEL ÅPNES. UNNGÅ EKSPONERING FOR STRÅLEN. |
| VORSICHT | - SICHTBARE UND UNSICHTBARE LASERSTRAHLUNG, WENN ABDECKUNG GEÖFFNET. NICHT DEM STRAHL AUSSETZEN. |
| 注意 | - 打开时有可见及不可见激光辐射。避免激光束照射。 |
| 注意 | - ここを開くと可視及び不可視のレーザー光が出ます。ビームを直接見たり、触れたりしないでください。 |

Precaution

Important Safety Instructions

Read these operating instructions carefully before using the unit. Follow all the safety instructions listed below. Keep these operating instructions handy for future reference.

- 1) Read these instructions.
- 2) Keep these instructions.
- 3) Heed all warnings.
- 4) Follow all instructions.
- 5) Do not use this apparatus near water.
- 6) Clean only with a dry cloth.
- 7) Do not block any ventilation openings, Install in accordance with the manufacturer's instructions.
- 8) Do not install near any heat sources such as radiators, heat registers, stoves, or other apparatus (including amplifiers) that produce heat.
- 9) Do not defeat the safety purpose of the polarized or grounding-type plug. A polarized plug has two blades with one wider than the other. A groundingtype plug has two blades and a third grounding prong. The wide blade or the third prong is provided for your safety. If the provided plug does not fit into your outlet, consult an electrician for replacement of the obsolete outlet.
- 10) Protect the power cord from being walked on or pinched particularly at plugs, convenience receptacles, and the point where they exit from the apparatus.
- 11) Only use attachments/accessories specified by the manufacturer.
- 12) Use only with the cart, stand, tripod, bracket, or table specified by the manufacturer, or sold with the apparatus. When a cart is used, use caution when moving the cart/ apparatus combination to avoid injury from tip-over. 
- 13) Unplug this apparatus during lightning storms or when unused for long periods of time.
- 14) Refer all servicing to qualified service personnel. Service is required when the apparatus has been damaged in any way, such as the power-supply cord or plug is damaged, liquid has been spilled or objects have fallen into the apparatus. Service is also required if the apparatus has been exposed to rain or moisture, does not operate normally, or has been dropped.

Handling Cautions

- Before connecting other components to this recorder, be sure to turn them all off.
- Do not move the recorder while a disc is being played, or the disc may be scratched or broken, and the recorder's internal parts may be damaged.
- Do not put a flower vase filled with water or any small metal objects on the recorder.
- Be careful not to put your hand into the disc tray.
- Do not place anything other than the disc in the disc tray.

- Exterior interference such as lightning and static electricity can affect normal operation of this recorder. If this occurs, turn the recorder off and on again with the POWER button, or disconnect and then reconnect the AC power cord to the AC power outlet. The recorder will operate normally.
- Be sure to remove the disc and turn off the recorder after use.
- Disconnect the AC power cord from the AC outlet when you don't intend to use the recorder for long periods of time.
- Clean the disc by wiping in a straight line from the inside to the outside of the disc.
- Apparatus shall not be exposed to dripping or splashing and no objects filled with liquids, such as vases, shall be placed on the apparatus.
- The Mains plug is used as a disconnect device and shall stay readily operable at any time.

Maintenance of Cabinet

For safety reasons, be sure to disconnect the AC power cord from the AC outlet.

- Do not use benzene, thinner, or other solvents for cleaning.
- Wipe the cabinet with a soft cloth.

Disc Handling

- Use discs with regular shapes. If an irregular disc (a disc with a special shape) is used, this DVD Recorder may be damaged.

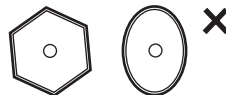

Holding discs

- Avoid touching the surface of a disc where recording is performed.



DVD-RAM, DVD-RW and DVD-R

- Clean with an optional DVD-RAM/PD disc cleaner. Do not use cleaners or cloths for CDs to clean DVDRAM/ DVD-RW/DVD-R discs.



DVD-Video, Audio CD

- Wipe off dirt or contamination on the disc with a soft cloth.

Cautions on handling discs

- Do not write on the printed side with a ball-point pen or pencil.
- Do not use record cleaning sprays or antistatic. Also, do not use volatile chemicals, such as benzene or thinner.
- Do not apply labels or stickers to discs. (Do not use discs fixed with exposed tape adhesive or leftover peeled-off stickers.)
- Do not use scratch-proof protectors or covers.
- Do not use discs printed with label printers available on the market.
- Do not load warped or cracked discs.

Disc Storage

Be careful not to damage the disc because the data on these discs are highly vulnerable to the environment.

- Do not keep under direct sunlight.
- Keep in a cool ventilated area.
- Store vertically.
- Keep in a clean protection jacket.
- If you move your DVD Recorder suddenly from a cold place to a warm place, condensation may generate on the operating parts including the lens and cause abnormal disc playback. When this occurs, do not connect the plug to the power outlet. Wait for two hours, then insert the disc and try to playback again. It will work properly when condensation has evaporated.

Disc Specifications

DVD-Video

- A digital versatile disc (DVD) can contain up to 135-minutes of images, 8-language audio and 32 subtitle languages. It is equipped with MPEG-2 picture compression and Dolby 3D surround sound, allowing you to enjoy vivid and clear theater quality images in the comfort of your own home.
- When switching from the first layer to the second layer of a double-layered DVD Video disc, there may be momentary distortion in the image and sound. This is not a malfunction of the unit.
- Once a DVD-R/DVD-RW(V) recorded is finalized, it is playable in a standard DVD player.

Audio CD

- An audio disc on which 44.1kHz PCM Audio is recorded
- Plays CD-DA format audio CD-R and CD-RW discs. The unit may not be able to play some CD-R or CD-RW discs due to the condition of the recording.

CD-R/-RW

◆ MP3 CD-R/-RW

- Only CD-R discs with MP3 files recorded with ISO9660 or JOLIET format can be played back
- Only MP3 files with the ".mp3", ".MP3" extension can be used.
- For MP3 files recorded with a VBR(Variable Bit Rates), from 32 Kbps to 320 Kbps, the sound may cut in out.
- Playable bitrate range is from 56Kbps to 320Kbps.
- The unit can handle a maximum of 1000 files and folders.
- DVD-RAM/DVD±RW/±R disc recorded with MP3 files can be played back.

◆ JPEG CD-R/-RW

- Only JPEG files with the ".jpg", ".JPG" extension can be used.
- The unit can handle a maximum of 1000 files and folders.
- Maximum size of progressive JPEG is 3M pixels.
- MOTION JPEG is not supported.
- DVD-RAM/±RW/±R discs that contain JPEG files can be played back.

◆ Using CD-R/-RW

- Use a 700MB(80 minutes) CD-R/-RW disc. If possible, do not use a 800MB(90 minutes) or above disc, as the disc may not play back.
- If the CD-R/-RW disc was not recorded as a closed session, you may experience a delay in the early playback time, and all recorded files may not play.
- Some CD-R/-RW discs may not be playable with this unit, depending on the device which was used to burn them.
- When recording from CDs for your personal use to CD-R/-RW discs, playability may vary depending on the contents and discs.

DVD-R Disc Playback and Recording

- Once a DVD-R recorded is finalized, it is playable in a standard DVD player. You can record onto the available space on the disc and perform editing functions such as giving titles to discs and programs and erasing programs before finalizing.
- When programming is erased from a DVD-R, that space does not become available. Once an area on a DVD-R is recorded on, that area is no longer available for recording, whether the recording is erased or not.
- It takes about 30 seconds for the unit to complete recording management information after recording finishes.
- This product optimizes the DVD-R for each recording. Optimization occurs when you start recording after inserting the disc or turning on the unit. Recording onto the disc may become impossible if optimization is carried out too many times.
- Playback may be impossible in some cases due to the condition of recording.
- This unit can play back DVD-R discs recorded and finalized with a Samsung DVD video recorder. It may not be able to play some DVD-R discs depending on the disc and the condition of the recording.

DVD-RW Disc Playback and Recording

- Recording and playback can be performed on DVD-RW discs in both the Video and VR Modes.
- Once a DVD-RW is recorded in VR or Video mode is finalized, you cannot perform additional recording.
- Once a DVD-RW is recorded in Video Mode and finalized, it becomes a DVD-Video.
- In both modes, playback can be performed before and after finalization, but additional recording, deleting and editing can not be performed after finalization.
- If you want to record the disc in VR Mode and then record in V Mode, be sure to first reformat the disc. Please be aware that formatting will erase all of the discs content.
- When inserting an unused disc, a message will appear asking whether to initialize the disc or not. If you select "YES", the disc will be formatted in VR mode.
- **DVD-RW (VR mode)**
 - This is a format that is used for recording data on a DVD-RW disc. You can record multiple titles, edit, delete, partial delete, create a playlist, etc.
 - A disc that is recorded in this mode will not play in standard DVD players.

- **DVD-RW (Video mode)**

- This is a format that is used for recording data on a DVD-RW or DVD-R disc. The disc can be played by an existing DVD player once it has been finalized.
- If a disc that has been recorded in Video Mode by a different manufacturer's recorder but has not been finalized, it cannot be played or recorded by this recorder.

DVD-RAM Disc Playback and Recording

- For cartridge type DVD-RAM discs, remove the cartridge and use only the disc
- Ensure that the recording mode is set to VR mode. Otherwise, this product will not be able to play the recording.
- You cannot play a DVD-RAM in most DVD players due to compatibility issues.
- Only DVD-RAM standard Version 2.0 discs can be played in this unit.
- DVD-RAM discs recorded on this unit may not work with other DVD Players. To determine compatibility with these DVD-RAM discs, refer to the user's manual for the player.

Do not use the following discs!

- LD, CD-G, CD-I, CD-ROM and DVD-ROM discs should not be used in this product.
- Some commercial discs and DVD discs purchased outside your region may not be playable with this product. When these discs are played, either "No Disc." or "The disc cannot be played. Please check the regional code of the disc." will be displayed.
- If your DVD-RAM/DVD-RW/DVD-R disc is an illegal copy or is not in DVD video format, it may also not be playable.

◆ Disc Compatibility

- Not all brands of discs will be compatible with this unit.
- The latest firmware upgrade to improve recording & playback quality can be downloaded from our web site. (Download Center at www.samsung.com)
- If disc compatibility problems continue, or there is an issue upgrading your recorder, contact the Call Center at 1-800-SAMSUNG.

COPY PROTECTION

- Many DVD discs are encoded with copy protection. Because of this, you should only connect your DVD Recorder directly to your TV, not to a VCR. Connecting your DVD recorder to a VCR results in a distorted picture from copy-protected DVD discs.
- This product incorporates copyright protection technology that is protected by methods claims of certain U.S. patents and other intellectual property rights owned by Macrovision Corporation and other rights owners. Use of this copyright protection technology must be authorized by Macrovision Corporation, and is intended for home and other limited viewing uses only unless otherwise authorized by Macrovision Corporation. Reverse engineering or disassembly is prohibited.

Protection

This DVD Recorder can allow you to protect the contents of your discs, as described below.

- Program-protection: See page 58 "Locking a Title"
- Disc-protection: See page 65 "Disc Protection"
- * DVD-RAM/DVD-RW/DVD-R discs that are incompatible with the DVD-VIDEO format cannot be played with this product.
- * For more information on DVD recording compatibility, consult your DVD-RAM/DVD-RW/DVD-R manufacturer.
- * Use of poor quality DVD-RAM/DVD-RW/DVD-R discs may cause the following unexpected problems including, recording failure, loss of recorded or edited materials or damage to the recorder.

Contents

Getting Started

| | |
|---|----|
| ■ Warning | 2 |
| ■ Precaution | 3 |
| Important Safety Instructions | 3 |
| Handling Cautions | 3 |
| Maintenance of Cabinet | 3 |
| Disc Handling | 3 |
| Disc Storage..... | 4 |
| Disc Specifications | 4 |
| ■ Contents | 6 |
| ■ General Features | 8 |
| ■ Before Reading the Instruction Manual | 9 |
| ■ How to use the DVD Recorder | 9 |
| ■ Unpacking | 10 |
| Accessories..... | 10 |
| Preparing the Remote Control | 10 |
| Tour of the Remote Control | 12 |
| ■ Description | 13 |
| Front Panel..... | 13 |
| Front Panel Display..... | 13 |
| Rear Panel | 14 |

Connecting & Setting Up

| | |
|--|----|
| ■ Step 1 : Connecting HDMI/DVI to a TV | 15 |
| Connecting to a TV with an HDMI Jack | 15 |
| Connecting to a TV with a DVI Jack..... | 16 |
| ■ Step 2 : Connecting the Video Cable | 17 |
| Connecting to Component Video Input Jacks (Y,P _B ,P _R)..... | 17 |
| Connecting to an S-Video Input Jack..... | 18 |
| Connecting to a Video Input Jack | 19 |
| ■ Step 3 : Connecting the Audio Cable | 20 |
| Connecting to your TV | 20 |
| Connecting to a Stereo Amplifier with Analog Input Jacks | 21 |
| Connecting to an AV Amplifier with a Digital Input Jack..... | 22 |
| ■ Step 4 : Connecting External Devices..... | 23 |
| Connecting a VCR, Set Top Box(STB) or DVD Player to the AV 1 IN or S-VIDEO IN jacks | 23 |
| Connecting a Camcorder | 24 |

System Setup

| | |
|---------------------------------------|----|
| ■ Initial Setup..... | 25 |
| OSD Language Setup | 25 |
| ■ Using the Setup Menu..... | 25 |
| ■ Setting Up the System Options | 26 |
| CM Skip Time Setting..... | 26 |
| EP Mode Time Setting | 27 |
| Automatic Chapter Creation..... | 27 |
| Quick Recording Setting | 28 |
| Anynet+(HDMI-CEC)..... | 28 |
| ■ Clock Set..... | 29 |
| ■ Language Setting | 29 |
| ■ Setting Up the Audio Options | 30 |
| ■ Video(Display) Setting..... | 31 |
| TV Aspect..... | 31 |
| Input Level..... | 31 |
| Black Level..... | 31 |
| 3D Noise Reduction | 31 |
| HDMI/DVI Resolution..... | 32 |
| ■ Parental Control | 32 |
| Setting the Rating Level | 33 |
| Changing the Password | 33 |

Recording

| | |
|--|----|
| ■ Recordable discs..... | 34 |
| Compatibility between Samsung and Other manufacturer's Recorders..... | 34 |
| ■ Recording Formats..... | 35 |
| DVD-RW(Video mode)/-R | 35 |
| DVD-RAM/-RW(VR mode)..... | 35 |
| ■ Recording Mode | 35 |
| ■ Unrecordable Video..... | 36 |
| About the INFO Button..... | 37 |
| ■ Recording from External Equipment | 38 |
| ■ Copying from a Camcorder | 39 |
| ■ Making a One Touch Recording (OTR) | 40 |
| ■ Setting a Timer Recording..... | 41 |
| ■ Flexible Recording (for Timer Recording only)..... | 42 |
| ■ Editing the Scheduled Record List | 42 |
| ■ Deleting the Scheduled Record List..... | 43 |
| ■ Recording the Scheduled Record List..... | 43 |
| ■ EZ REC MODE | 44 |

Playback

| | |
|---|----|
| ■ Region code (DVD-Video only) | 45 |
| ■ Logos of Discs that can be played | 45 |
| ■ Disc types that can be played | 45 |
| Discs That Cannot be Played..... | 46 |
| ■ Playing a Disc..... | 46 |
| Using the Disc Menu & Title Menu | 47 |
| Using the Playback Related Buttons..... | 47 |
| Slow Motion Play..... | 48 |
| Step Motion Play | 48 |
| Using the ANYKEY Button | 49 |
| ■ Playing an Audio CD/MP3 | 53 |
| Playing an Audio CD(CD-DA) | 53 |
| Playing an MP3 Disc..... | 54 |
| Playing Repeatedly | 54 |
| ■ Playing a Picture CD | 55 |
| ■ Playing the Title List | 56 |

Additional Information

| | |
|---------------------------------|----|
| ■ Troubleshooting..... | 68 |
| ■ Error Message Solutions | 70 |
| ■ Specifications | 72 |
| ■ Warranty | 73 |

Editing

| | |
|--|----|
| ■ Basic Editing (Title List)..... | 57 |
| Renaming (Labeling) a Title | 57 |
| Locking (Protecting) a Title..... | 58 |
| Deleting a Title | 58 |
| Deleting a Section of a Title | 59 |
| ■ Advanced Editing (Playlist)..... | 60 |
| Creating a Playlist | 60 |
| Playing Entries in the Playlist | 60 |
| Renaming a Playlist Entry | 61 |
| Editing a Scene for the Playlist | 61 |
| Copying a Playlist Entry to the Playlist..... | 64 |
| Deleting a Playlist Entry from the Playlist..... | 64 |
| ■ Disc Manager | 64 |
| Editing the Disc Name..... | 64 |
| Disc Protection | 65 |
| Formatting a Disc | 65 |
| Finalizing a Disc | 66 |
| Unfinalizing a Disc (V/VR mode)..... | 66 |
| Delete All Title Lists | 67 |

General Features

The DVD-R155 allows you to record and play high quality digital video on DVD-RAM/DVD-RW/DVD-R discs.

High quality digital audio and video recording and playback

You can record up to approximately 16-hours of video on a double side 9.4 GB DVD-RAM disc, up to 15-hours on a dual-layer 8.5GB DVD-R disc, and up to 8-hours on a 4.7 GB DVD-RAM/DVD-RW/DVD-R disc, depending on the recording mode.

Selectable Record Mode

You can set your recorder to one of five different recording speeds, each varying in recording quality and length. EP mode yields the most recording time, LP & SP modes provide less recording time with higher quality recording, and XP mode gives you the highest quality recording. There's also the FR (Flexible Recording) mode that lets you record with the best picture quality possible for the recording time and remaining space on the disc in timer recording.

Automated Quality Adjustment for Timer Recording

If FR mode is selected, the video quality is adjusted automatically so that all video for the scheduled time can be recorded onto the free disc space. (See pages 41-42)

Create a DVD video title using a DVD-RW/DVD-R disc

With the DVD-R155, you can create your own DVD video title on 4.7 GB DVD-RW/DVD-R or 8.5GB DVD-R discs.

Copying data from a digital camcorder using a DV input jack

Record digital camcorder video onto DVD-RAM, DVD-RW or DVD-R discs using the DV input jack (IEEE 1394-4pin). (See page 39.)

High quality progressive scan

Progressive scanning provides high resolution and flicker free video.

The 10-bit 54-MHz DAC and 2D Y/C Separating Circuitry provides the highest video playback and recording quality. (See page 17.)

A variety of functions with an easy-to-use user interface

The integrated menu system and the messaging function allows you to perform desired operations both easily and conveniently. With a DVD-RAM or DVD-RW (VR mode) disc, you can edit recorded images, create a playlist, and edit videos in a specific sequence according to your requirements.

HDMI (High Definition Multimedia Interface)

HDMI reduces picture noise by allowing a pure digital video/audio signal path from the DVD Recorder to your TV.



Tunerless DVD Recorder

The DVD-R155 does not have a TV tuner. Recording TV broadcasts is possible via Connection to Cable/Satellite boxes and Multi Channel Video Services.













EZ REC MODE

This function allows you Initialize and Finalize a disc automatically. (See page 44.)

Before Reading the Instruction Manual

Make sure to check the following before reading the user's manual.

Icons that will be used in manual

| Icon | Term | Definition |
|---|------------------|---|
|  | DVD | This involves a function available with DVD or DVD-R/DVD-RW(V) discs that have been recorded and finalized. |
|  | RAM | This involves a function available with DVD-RAM discs. |
|  | -RW | This involves a function available with DVD-RW discs. |
|  | -R | This involves a function available with DVD-R discs. |
|  | +RW | This involves a function available with DVD+RW discs. |
|  | +R | This involves a function available with DVD+R discs. |
|  | CD | This involves a function available with a data CD (CD-R or CD-RW). |
|  | JPEG | This involves a function available with CD-R/-RW or DVD-RAM/DVD±RW/DVD±R discs. |
|  | MP3 | This involves a function available with CD-R/-RW or DVD-RAM/DVD±RW/DVD±R discs. |
|  | Caution | This involves a case where a function does not operate or settings may be cancelled. |
|  | NOTE | This involves tips or instructions on the page that help each function operate. |
|  | One-Touch button | A function that can be operated by using only one button. |
|  | ANYKEY button | A function that can be operated by using the ANYKEY button. |

About the use of this Instruction Manual

- 1) Be sure to familiarize yourself with the Safety Instructions before using this product. (See pages 2 ~ 5)
- 2) If a problem occurs, check the Troubleshooting section. (See pages 68 ~69)

Copyright

©2007 Samsung Electronics Co.
All rights reserved; No part or whole of this user's manual may be reproduced or copied without the prior written permission of Samsung Electronics Co.

How to use the DVD Recorder

Step 1 : Select the disc type

This unit can record on the following types of discs. If you want to repeatedly record on the same disc or you want to edit the disc after recording, select a rewritable DVD-RW or DVD-RAM type disc. If you want to save the recording without making any changes, choose a non-rewritable DVD-R.



Step 2 : Format the disc to start recording

The recorder automatically starts formatting when an unused disc is inserted. This is required for the preparation of disc recording.

Using a DVD-RAM

This type of disc can be formatted in DVD-Video Recording format (VR mode). You can edit recorded video, create a playlist or edit video in a specific sequence according to your requirements.

Using a DVD-RW

- When an unused DVD-RW disc is first inserted, the message "Uninitialized Disc. Do you want to initialize this disc?" will be displayed. If you select Yes, initializing will begin. A DVD-RW disc can be formatted in either DVD-Video format (Video mode) or DVD-Video Recording format (VR mode)

Using a DVD-R

When using a DVD-R disc, only V mode recording is possible and no initialization is needed to play it on this recorder. However, finalization is necessary to play this disc on other DVD players.



- You can only use either the VR or Video mode on a DVD-RW, but not both at the same time.
- You can format a DVD-RW to V or VR mode using disc manager. It should be noted that the disc's data will be lost when changing formats.

Step 3 : Recording

There are two different recording methods. Direct Recording (recording a program you are currently watching) and Timer Recording. Timer recording is determined as a Date : MM/DD, MON-FRI, Every SAT, etc.. There are 5 recording modes : XP(high quality mode), SP(standard quality mode), LP(long recording mode), EP(extended mode) and FR mode. When using FR mode to record, the picture quality is determined by the remaining time on the disc.

Step 4 : Playing

To start playback select the title you want to play from the Title list.

A DVD consists of sections called titles, and sub sections called chapters.

During recording, a title is created between two points where you start and stop recording. Chapters will be created automatically when you finalize recording on DVD-R/DVD-RW discs in Video mode.

Step 5 : Editing a recorded disc

Editing a DVD disc is easier than editing on conventional video tapes. The recorder supports many different editing functions, possible only with DVDs.

With a simple and easy edit menu, you can perform various editing functions, such as delete, copy, rename, lock, etc., on a recorded title.

With this recorder, you can create playlists using a DVD-RAM/DVD-RW in VR mode. Once a playlist is created you can create/edit a new playlist on the same disc without changing the original recording.

Step 6 : Finalizing & Playing on other DVD components

To play your DVD on other DVD components, finalizing may be necessary. First, finish all editing and recording operations, then finalize the disc.

When using a DVD-RW disc in VR Mode

Although finalizing is generally unnecessary when playing the disc on a VR Mode compatible component, a finalized disc should be used for playback.

When using a DVD-RW disc in Video Mode

The disc should be finalized first to enable playback on other DVD players. No more editing or recording can be made on the disc once it has been finalized.

When using a DVD-R disc

The disc should be finalized first to enable playback on other DVD players. No more editing or recording can be made on the disc once it has been finalized.



- You can finalize automatically using the EZ REC MODE. (See page 44)

Unpacking

Accessories

Check for the supplied accessories below.

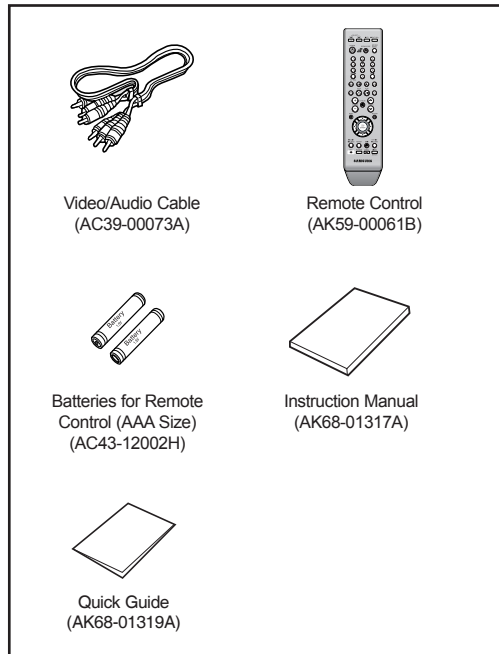

Preparing the Remote Control

Install Batteries in the Remote Control

- Open the battery cover on the back of the remote.
- Insert two AAA batteries. Make sure that the polarities (+ and -) are aligned correctly.
- Replace the battery cover.

If the remote control does not operate properly:

- Check the polarity + - of the batteries.
- Check if the batteries are drained.
- Check if the remote sensor is blocked by obstacles.
- Check if there is any fluorescent lighting nearby.

Dispose of the batteries according to local environmental regulations. Do not put them in the household trash.

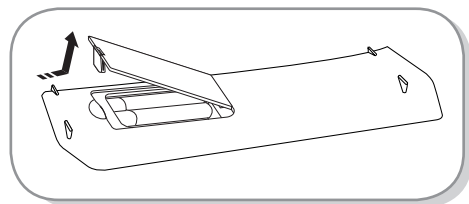

To determine whether your television is compatible, follow the instructions below.

1. Switch your television on.
2. Point the remote control towards the television.
3. Press and hold the **POWER** button and enter the two-figure code simultaneously corresponding to the brand of your television by pressing the appropriate number buttons.

| Brand | BUTTON |
|--------------------|--|
| AIWA | 82 |
| ANAM | 10, 11, 12, 13, 14, 15, 16, 17, 18 |
| BANG & OLUFSEN | 57 |
| BLAUPUNKT | 71 |
| BRANDT | 73 |
| BRIONVEGA | 57 |
| CGE | 52 |
| CONTINENTAL EDISON | 75 |
| DAEWOO | 19, 20, 23, 24, 25, 26, 27, 28, 29, 30, 31, 32, 33, 34 |
| EMERSON | 64 |
| FERGUSON | 73 |
| FINLUX | 06, 49, 57 |
| FORMENTI | 57 |
| FUJITSU | 84 |
| GRADIENTE | 70 |
| GRUNDIG | 49, 52, 71 |
| HITACHI | 60, 72, 73, 75 |
| IMPERIAL | 52 |
| JVC | 61, 79 |
| LG | 06, 19, 20, 21, 22, 78 |
| LOEWE | 06, 69 |
| LOEWE OPTA | 06, 57 |
| MAGNAVOX | 40 |
| METZ | 57 |
| MITSUBISHI | 06, 48, 62, 65 |
| MIVAR | 52, 77 |
| NEC | 83 |
| NEWSAN | 68 |
| NOBLEX | 66 |
| NOKIA | 74 |
| NORDMENDE | 72, 73, 75 |
| PANASONIC | 53, 54, 74, 75 |
| PHILIPS | 06, 55, 56, 57 |
| PHONOLA | 06, 56, 57 |
| PIONEER | 58, 59, 73, 74 |
| RADIOLA | 06, 56 |
| RADIOMARELLI | 57 |
| RCA | 45, 46 |
| REX | 74 |

| BRAND | BUTTON |
|--------------|----------------------------|
| SABA | 57, 72, 73, 74, 75 |
| SALORA | 74 |
| SAMSUNG | 01,02,03,04,05,06,07,08,09 |
| SANYO | 41, 42, 43, 44, 48 |
| SCHNEIDER | 06 |
| SELECO | 74 |
| SHARP | 36, 37, 38, 39, 48 |
| SIEMENS | 71 |
| SINGER | 57 |
| SINUDYNE | 57 |
| SONY | 35, 48 |
| TELEAVA | 73 |
| TELEFUNKEN | 67, 73, 75, 76 |
| THOMSON | 72, 73, 75 |
| THOMSON ASIA | 80, 81 |
| TOSHIBA | 47, 48, 49, 50, 51, 52 |
| WEGA | 57 |
| YOKO | 06 |
| ZENITH | 63 |

Result: If your television is compatible with the remote control, it will switch off.
It is now programmed to operate with the remote control.



- If several codes are indicated for your television brand, try each one in turn until you find one that works. If you replace the remote control's batteries, you must set the brand code again.

You can then control the television using the following buttons.

| Button | Function |
|------------|--|
| POWER | Used to switch the television on and off. |
| INPUT SEL. | Used to select an external source. |
| TV VOL +/- | Used to adjust the volume of the television. |
| TV CH | Used to select the desired channel. |
| TV MUTE | Used to toggle the sound on and off. |
| 0~9 | Used to input number directly. |
| TV 100+ | Used to select channels over 100. |



- The various functions may be able to be controlled on all televisions. If you encounter problems, operate the television directly.

Tour of the Remote Control

You can control part of another manufacturer's TV functions with this remote control.

• Buttons that can be controlled on your TV : POWER, INPUT SEL., TV VOL (+/-), TV CH (^/∨), TV MUTE, 0~9, TV 100+.

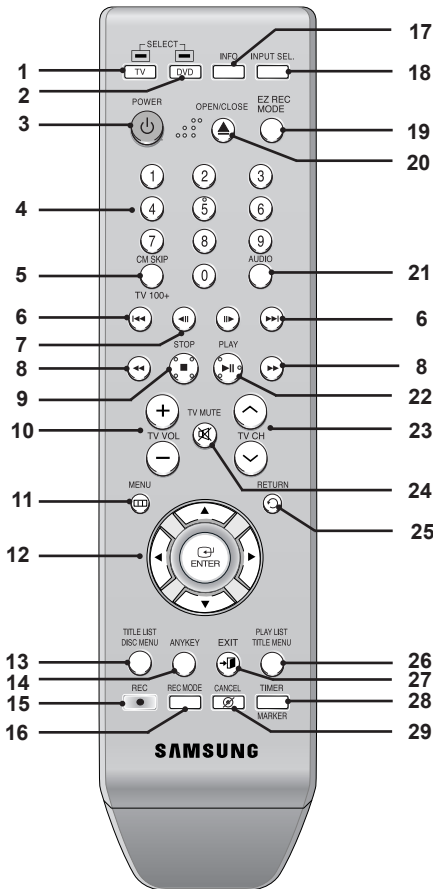

1. **TV Button**
Press this to operate your TV.
2. **DVD Button**
Press this to operate your DVD Recorder.
3. **POWER Button**
Press to power the DVD Recorder on and off.
4. **NUMBER Buttons**
5. **TV 100+/CM SKIP Button**
Press this to select channel 100 or higher.
Press this to skip a portion of the program automatically during playback of a DVD disc.
6. **REVERSE/FORWARD SKIP Buttons**
Press to skip a disc backwards or forwards.
7. **REVERSE/FORWARD STEP Buttons**
Press to play frame by frame.
8. **REVERSE/FORWARD SEARCH Buttons**
Press to search a disc backwards or forwards.

9. **STOP Button**
Press to stop a disc or to stop the recording.
10. **TV VOL Buttons**
Volume adjustment.
11. **MENU Button**
Brings up the DVD recorder's setup menu.
12. **ENTER/DIRECTION Buttons**
(UP/DOWN and LEFT/RIGHT Buttons)
This button functions as a toggle switch.
13. **TITLE LIST/DISC MENU Button**
Use this to enter the View Recording list/Disc menu.
14. **ANYKEY Button**
Use this to view the status of the disc that is being played.
15. **REC Button**
Use to make a recording on writable/rewritable discs.
16. **REC MODE Button**
Use this to set the desired Recording time and picture quality. (XP/SP/LP/EP)
17. **INFO Button**
This will display current setting or disc status.
18. **INPUT SEL. Button**
Selects line input signal in external input mode. (AV1, AV2 or DV)
19. **EZ REC MODE Button**
Use this to set the EZ REC MODE.
20. **OPEN/CLOSE Button**
To open and close the disc tray.
21. **AUDIO Button**
Use this to access various audio functions on a disc. (DVD mode)
22. **PLAY/PAUSE Button**
Press to play/pause a disc.
23. **TV CH Buttons**
Use this to select a TV channel.
24. **TV MUTE Button**
This operates as Sound Mute. (TV mode)
25. **RETURN Button**
Returns to the previous menu.
26. **PLAY LIST/TITLE MENU Button**
Use this to return to the Title menu, or to view the recorded Playlist.
27. **EXIT Button**
Exit the current menu.
28. **TIMER/MARKER Button**
Press to directly enter the Timer Recording Mode menu.
Use this to Bookmark or mark a position while playing a disc.
29. **CANCEL Button**

* This is a special remote control for the visually impaired, and has Braille points on the POWER(Ⓜ), STOP(Ⓢ) and PLAY(Ⓜ) buttons.

Description

Front Panel

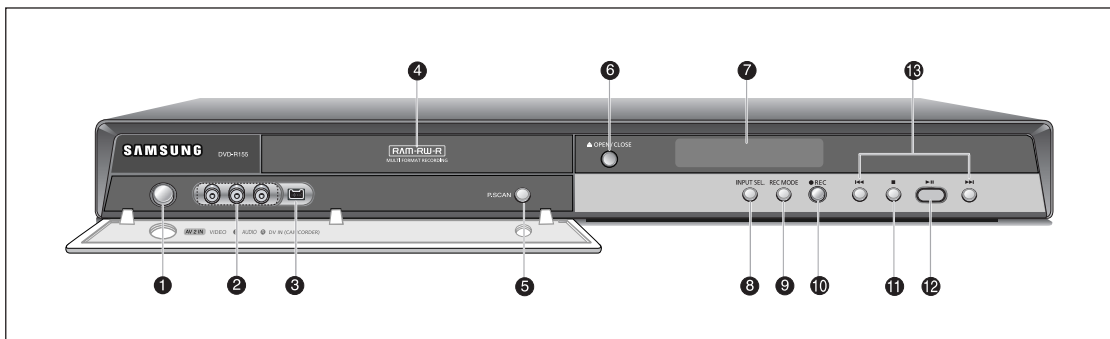

1. **POWER Button**
Turns the recorder on and off.
2. **AV 2 IN**
Connects external equipment.
3. **DV-IN**
Connects external digital equipment with a DV jack. (such as a camcorder)
4. **DISC TRAY**
Opens a disc.
5. **P.SCAN Button**
Selects the progressive scan mode.
6. **OPEN/CLOSE Button**
Opens and closes the disc tray.
7. **DISPLAY**
Displays the playing status, time, etc.
8. **INPUT SEL. Button**
Selects line input signal in external mode. (AV1, AV2, or DV)
9. **REC MODE Button**
Uses this to set the desired Recording time and picture quality. (XP/SP/LP/EP)
10. **REC Button**
Starts recording.
11. **STOP Button**
Stops disc playback.
12. **PLAY/PAUSE Button**
Plays a disc or pauses playback.
13. **SKIP Buttons**
Goes to the next title/chapter/track, or go back to the previous title/chapter/track.

Front Panel Display

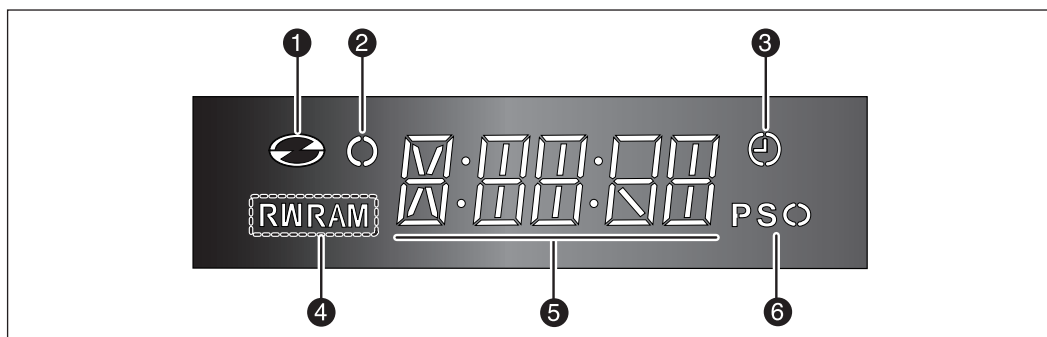

1. Lights when a disc is loaded.
2. Lights in the record mode.
3. Lights to indicate the timer record mode.
4. Lights when a DVD-RAM/DVD±RW/DVD±R disc is loaded.
5. Alpha/Numeric display.
6. Lights in the progressive scan mode.

Rear Panel

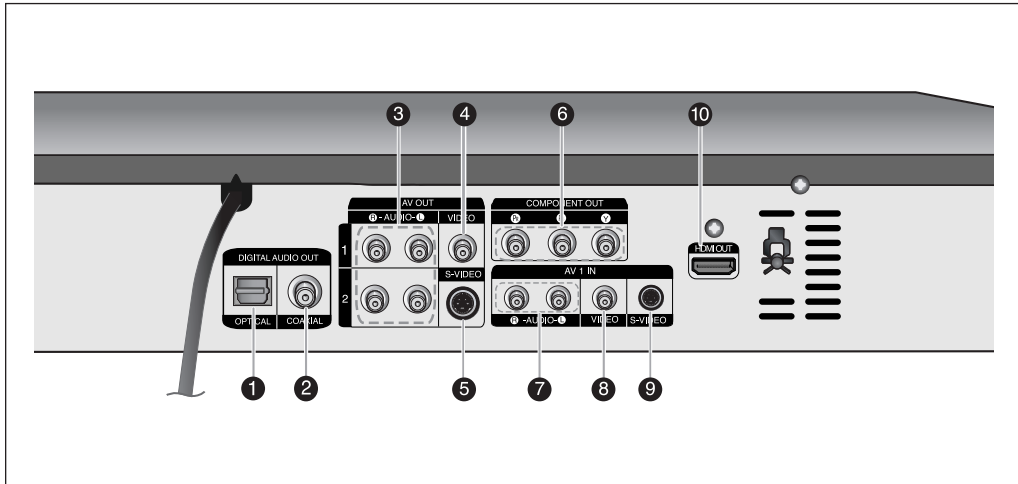

1. **DIGITAL AUDIO OUT (OPTICAL)**
Connects to an amplifier having a digital optical audio input jack.
2. **DIGITAL AUDIO OUT (COAXIAL)**
Connects to an amplifier having a digital coaxial audio input jack.
3. **AV AUDIO OUT**
Connects to the audio input of external equipment using audio cables.
4. **AV VIDEO OUT (good video quality)**
Connects the input of external equipment using a Video cable.
5. **AV S-VIDEO OUT (better video quality)**
Connects the input of external equipment using an S-Video cable.
6. **COMPONENT VIDEO OUT (excellent video quality)**
Connects to equipment having Component video input jacks.
7. **AV 1 AUDIO IN**
Connects the output of external equipment using audio cables
8. **AV 1 VIDEO IN**
Connects the output of external equipment using a video cable.
9. **AV 1 S-VIDEO IN**
Connects the output of external equipment using an S-Video cable.
10. **HDMI OUT (best video quality)**
Connects the input of external equipment using a HDMI cable.



Connecting & Setting Up

Step 1 : Connecting HDMI/DVI to a TV

If your TV has a HDMI/DVI input, connect an HDMI/DVI cable to your TV. You will enjoy the best quality image and sound.

Connecting to a TV with an HDMI Jack

Using an HDMI- HDMI cable (not included) connect the HDMI OUT jack on the rear of the DVD Recorder to the HDMI IN jack of your TV. Press the input selector on your TV remote control until the HDMI signal from the DVD Recorder appears on your TV screen.

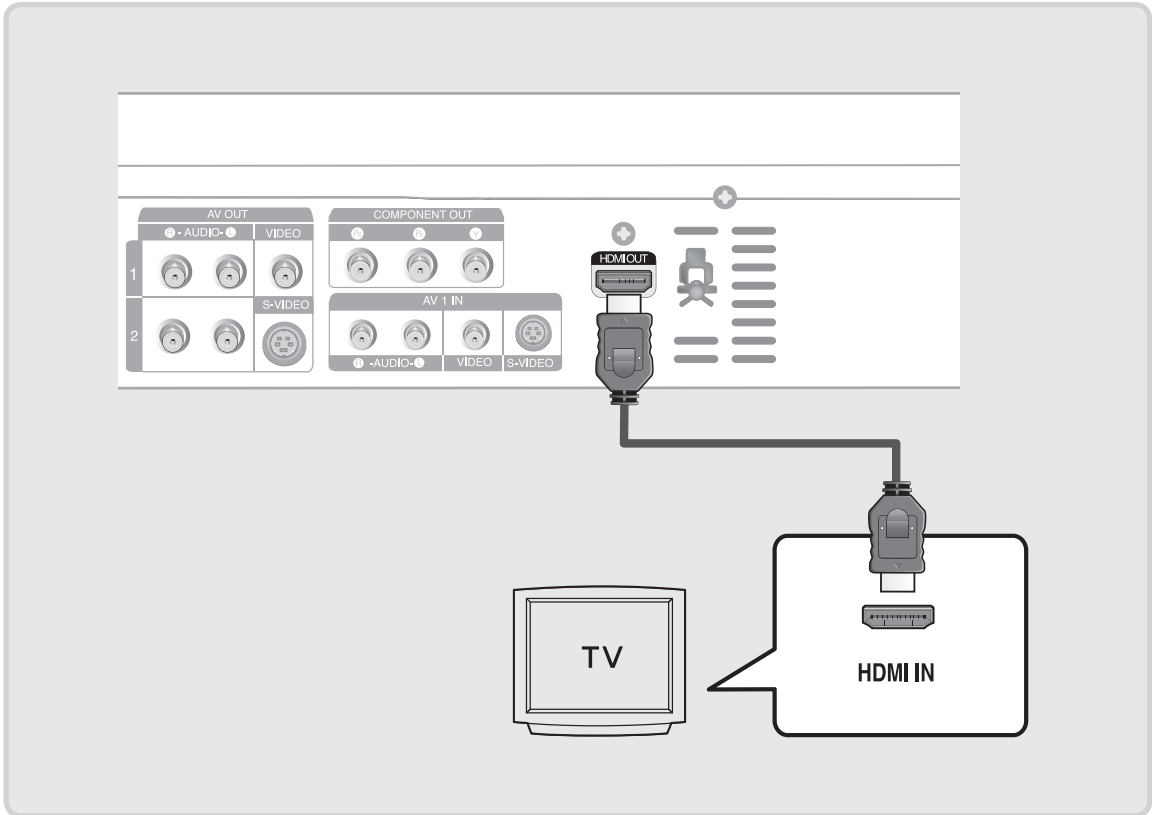

- To watch through the HDMI output, set the digital audio output to PCM.(See page 30)
- Depending on the HDMI device(TV/HDMI Receiver) you use, audio may not be supported. If your TV does not support Dolby digital/DTS, Audio output is not available when you set the Digital output to Bitstream or select DTS On in the Audio setup menu. In this case, set the digital audio output to PCM or DTS Off.
- If you use an HDMI cable to connect a Samsung TV to the DVD recorder, you can operate the recorder using the TV's remote control. (This is only available with SAMSUNG TVs that support Anynet+(HDMI-CEC).) (See page 28)
- Please check the *Anynet+* logo (If your TV has an *Anynet+* logo, then it supports Anynet+ function.)

Connecting to a TV with a DVI Jack

Using an HDMI-DVI cable (not included), connect the HDMI OUT terminal on the rear of the DVD Recorder to the DVI IN terminal of your TV.

An HDMI to DVI connection requires a separate audio connection. Using the audio cables, connect the AUDIO (red and white) OUT terminals on the rear of the DVD Recorder to the AUDIO (red and white) IN terminals of your TV. Turn on the DVD Recorder and TV.

Press the input selector on your TV remote control until the DVI signal from the DVD Recorder appears on your TV screen.

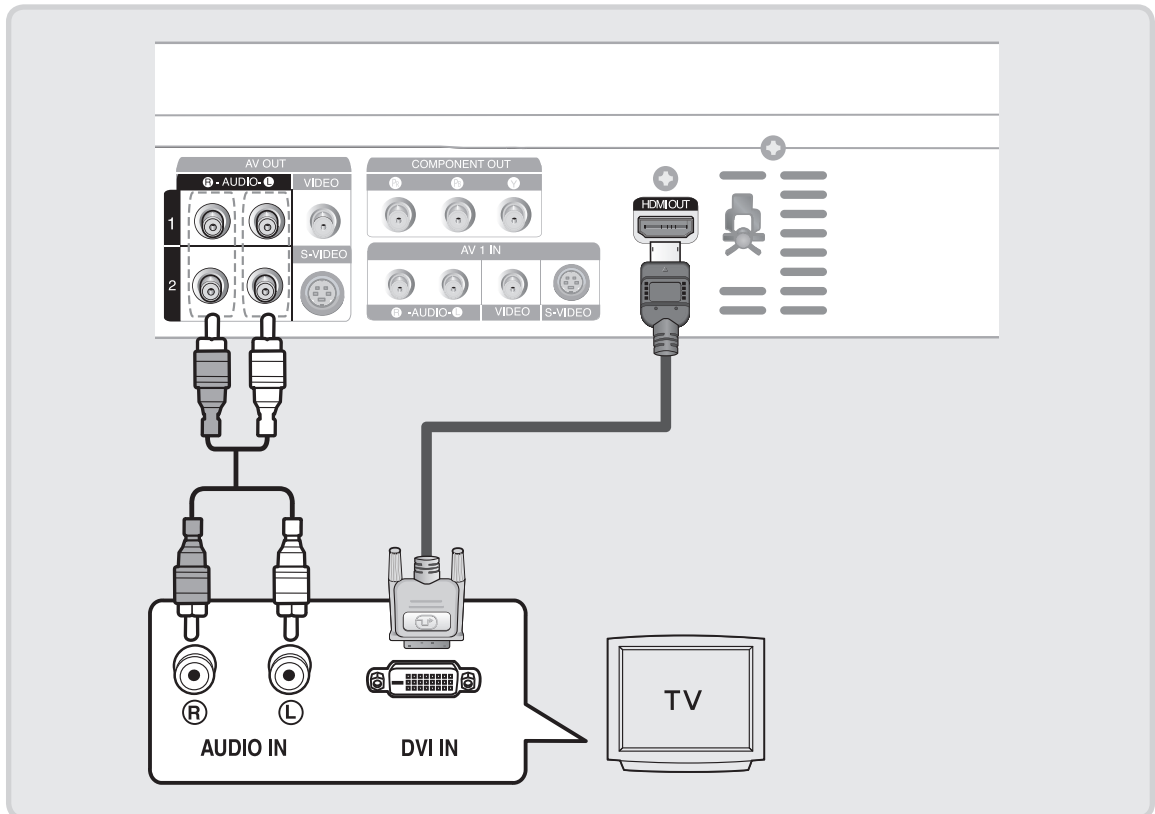

- To set the HDMI output resolution(480p/720p/1080i), see page 32.

- **HDMI (High Definition Multimedia Interface)**

HDMI enables you to make a digital video and audio connection with a single cable. Using HDMI, the DVD player transmits a digital video and audio signal and displays a vivid picture on a TV having an HDMI input jack.

- HDMI is completely compatible with DVI. The only difference between HDMI and DVI is that HDMI supports multi-channel audio.

- **HDMI connection description**

HDMI connector - Both uncompressed video data and digital audio data (LPCM or Bit Stream data).
 - The DVD recorder outputs a pure digital signal to the TV.

- If your TV does not support HDCP (Highbandwidth Digital Content Protection), snow noise appears on the screen.

- **Why does Samsung use HDMI?**

Analog TVs require an analog video/audio signal. However, when playing a DVD, the data transmitted to a TV is digital. Therefore either a digital-to-analog converter (in the DVD Recorder) or an analog-to-digital converter (in the TV) is required. During this conversion, the picture quality is degraded due to noise and signal loss. HDMI technology is superior because it requires no D/A conversion and is a pure digital signal from the DVD recorder to your TV.

- **What is the HDCP?**

HDCP (High-bandwidth Digital Content Protection) is a system for protecting DVD content output via HDMI from being copied. It provides a secure digital link between a video source (PC, DVD, etc) and a display device (TV, projector, etc). Content is encrypted at the source device to prevent unauthorized copies from being made.

Step 2 : Connecting the Video Cable

There are several ways to connect your DVD Recorder. Select one of the video connections on the following pages.

You must use one of the following audio/video connections on this unit.

Connecting to Component Video Input Jacks (Y,P_B,P_R)

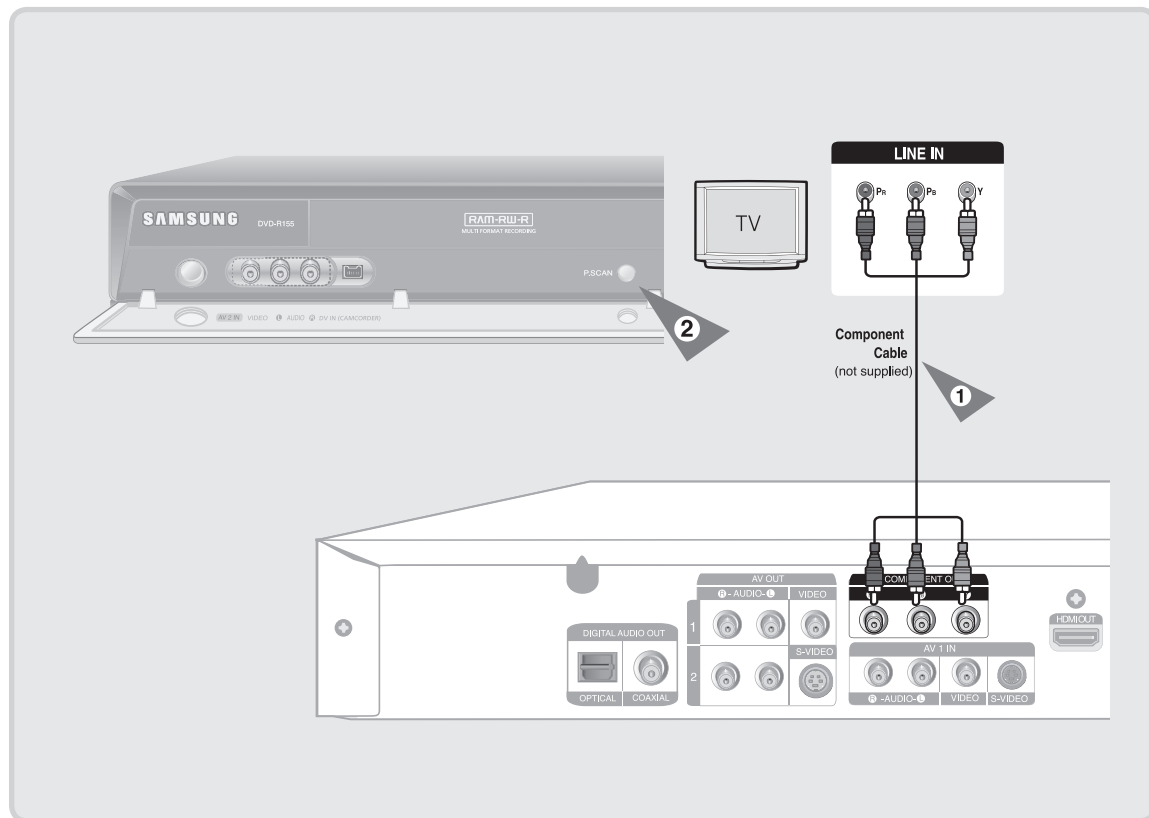

1. Connect the Component video cables(not supplied) between the COMPONENT OUT(Y,P_B,P_R) jacks on the DVD Recorder and COMPONENT IN(Y,P_B,P_R) jacks on your TV (or AV amplifier).
This connection outputs the 480i or 480p resolution to your TV.
 2. If the connected TV supports Progressive Scan, press the P.SCAN button on the front of the DVD Recorder to enjoy best quality video. Pressing the **P.SCAN** button alternately switches the Progressive(480p) or Interlace(480i) scan mode on.
- You will enjoy the best quality accurate color reproduction images. Component video separates the picture element into black and white(Y), blue(P_B) and red(P_R) signals to present clear and clean images.
 - Connect the audio cables(white and red) between the AUDIO OUT jacks on the DVD Recorder and AUDIO IN jacks on your TV(or AV amplifier). (See pages 20~22)



- Compared to standard interlaced video, progressive scan doubles the amount of video lines fed to your TV, resulting in a clearer, more stable, and flicker free image than interlaced video. The component output jack of the DVD player can be used for progressive output mode, which is only available with TVs that support progressive scan.
- Progressive Scan Output (480p).
Not all high definition television sets are fully compatible with this product. If the 480p progressive scan picture is not satisfactory, press the **P.SCAN** button on the unit to switch to the Interlace mode.
If there are questions regarding TV set compatibility with this model, please contact our customer service center at 1-800-SAMSUNG.
- The Component jacks will not output video resolutions above 480p. To view 720p and 1080i, connect the DVD-R155 to your TV with an HDMI-HDMI cable. With HDMI connected, press the **P.SCAN** button to alternate between all available resolutions. (See page 32)

Connecting to an S-Video Input Jack

Connect an S-Video cable(not supplied) between the S-VIDEO OUT jack on DVD Recorder and S-VIDEO IN jack on your TV (or AV amplifier).

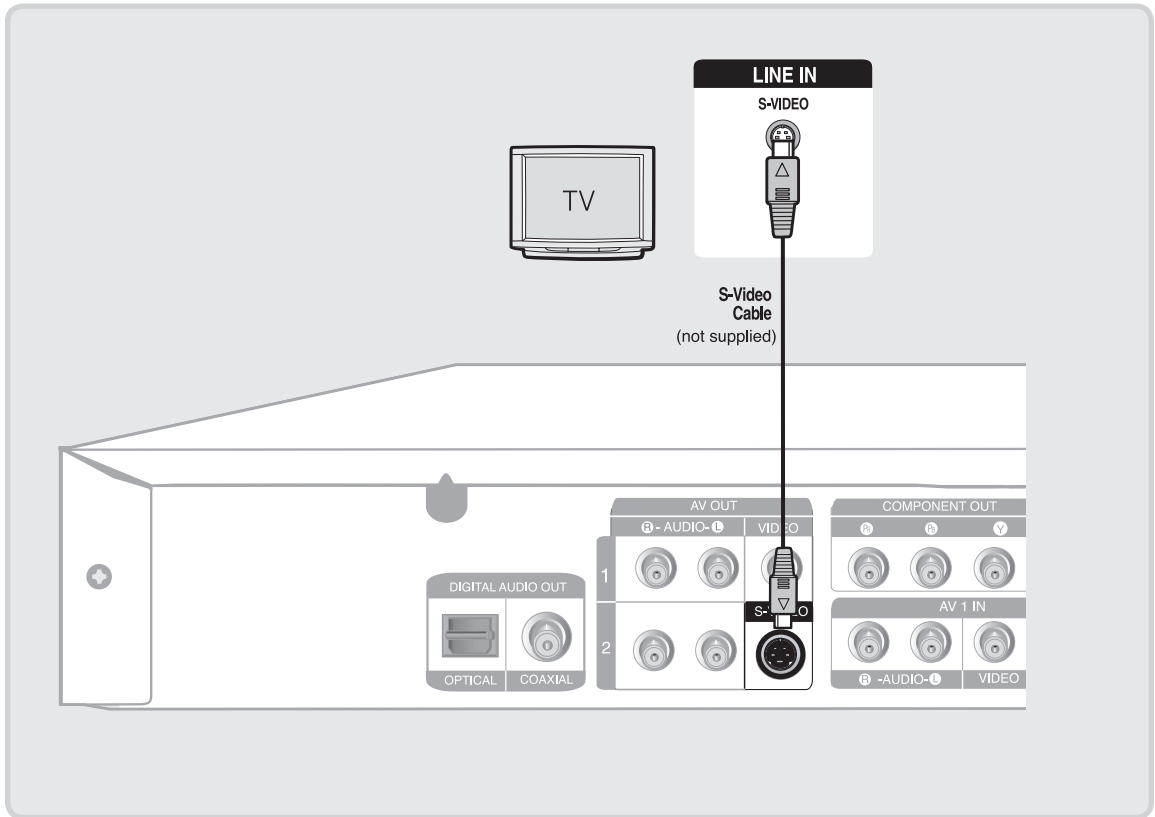

- You will enjoy high quality images. S-Video separates the picture element into black and white (Y) and color (C) signals to present clearer images than regular video input mode. This connection outputs the 480i resolution to your TV.
- Connect the audio cables(white and red) between the AUDIO OUT jacks on the DVD Recorder and AUDIO IN jacks on your TV(or AV amplifier). (See pages 20~22)



- S-Video or Component video outputs are available only if your TV supports S-Video input or Component video input, respectively. If S-Video or Component video output does not work, check your TV connections and the TV input selection settings.

Connecting to a Video Input Jack

Connect a video(yellow) cable between the VIDEO(yellow) OUT jack on DVD Recorder and VIDEO(yellow) IN jack on the TV (or AV amplifier).

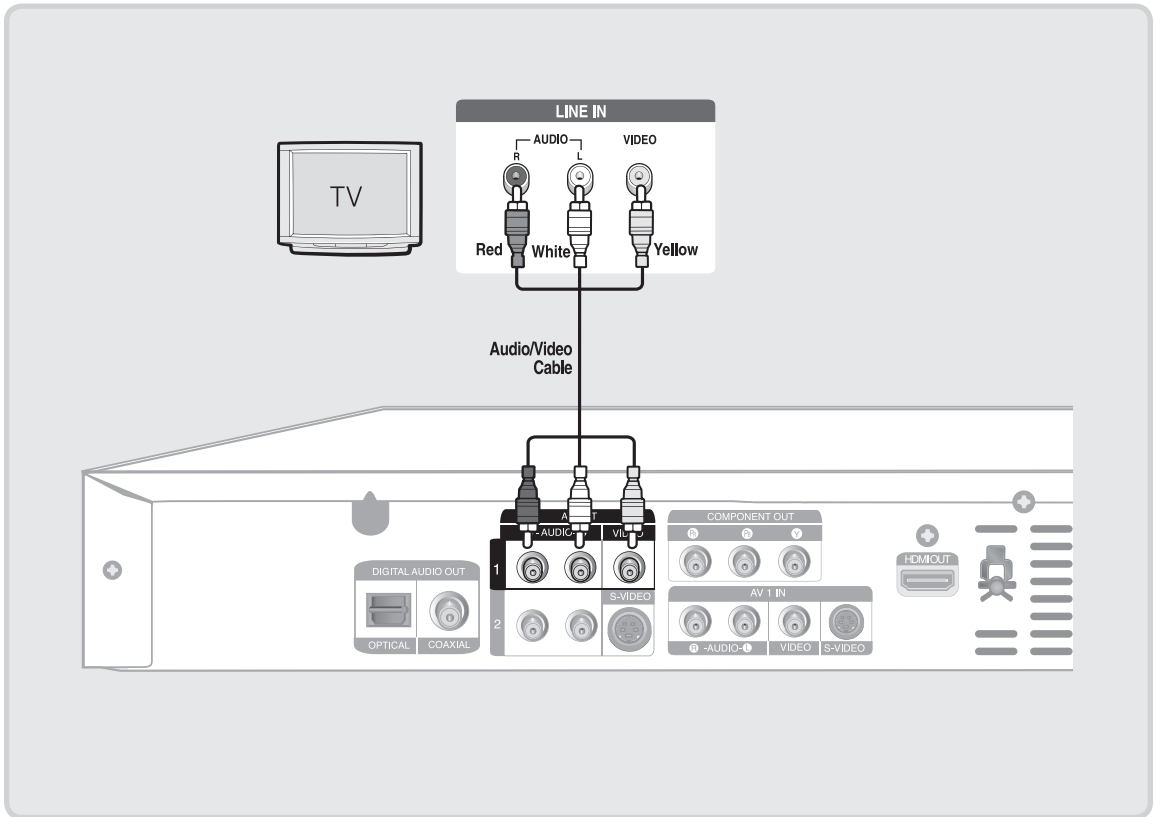

- You will enjoy normal quality images. This connection outputs the 480i resolution to your TV.
- Connect the audio cables(white and red) between the AUDIO OUT jacks on the DVD Recorder and AUDIO IN jacks on your TV(or AV amplifier). (See pages 20~22)

Step 3 : Connecting the Audio Cable

Select one of the Audio connections on the following pages.

Connecting to your TV

This connection will use your TV's speakers.

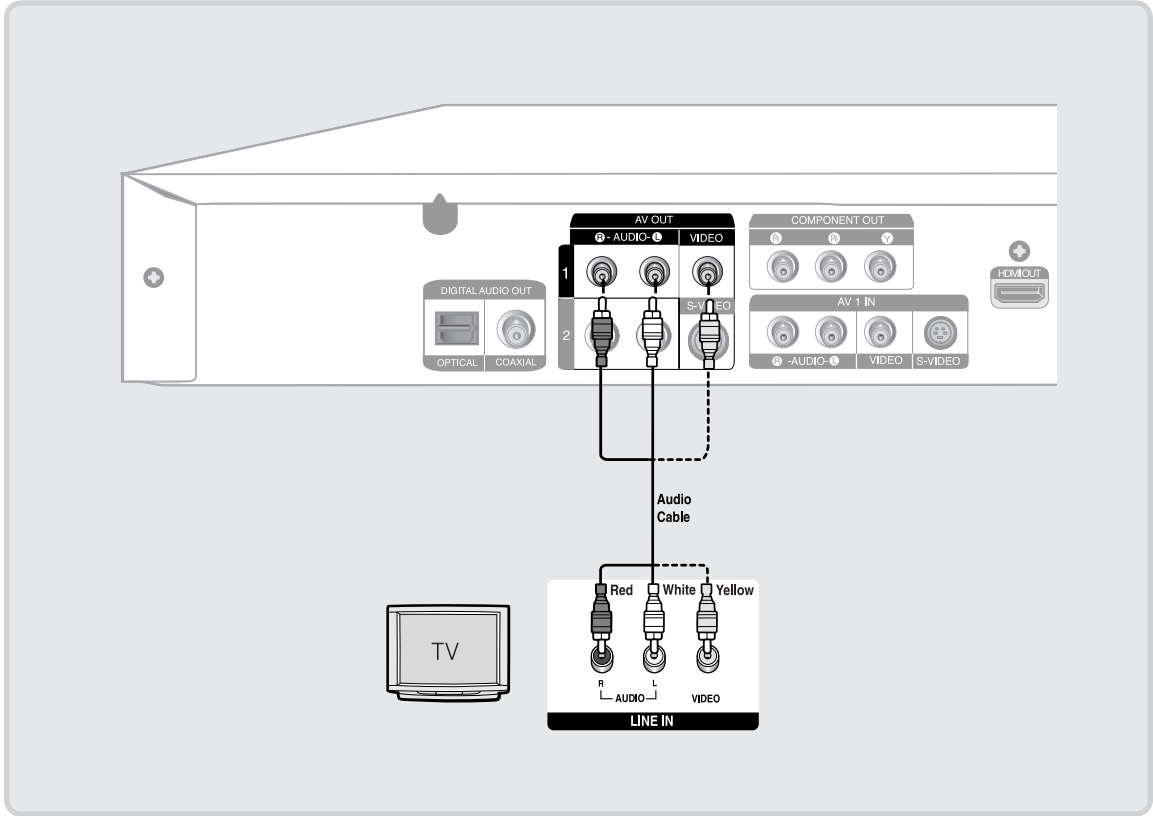

Connecting to a Stereo Amplifier with Analog Input Jacks

If your stereo amplifier only has AUDIO INPUT jacks(L and R), use the AUDIO OUT jacks.

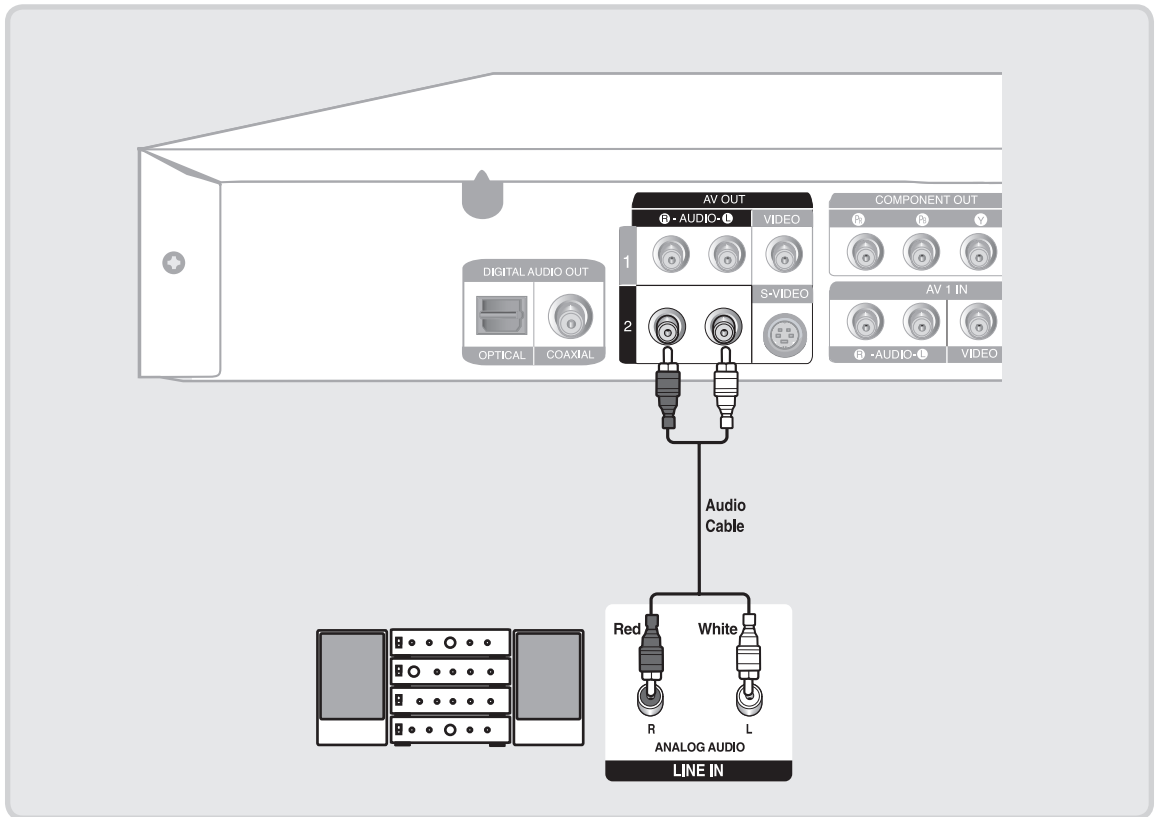

Connecting to an AV Amplifier with a Digital Input Jack

If your AV amplifier has a Dolby Digital or DTS decoder and a digital input jack, use this connection. To enjoy Dolby Digital or DTS sound, you will need to set up the audio settings. (See page 30)

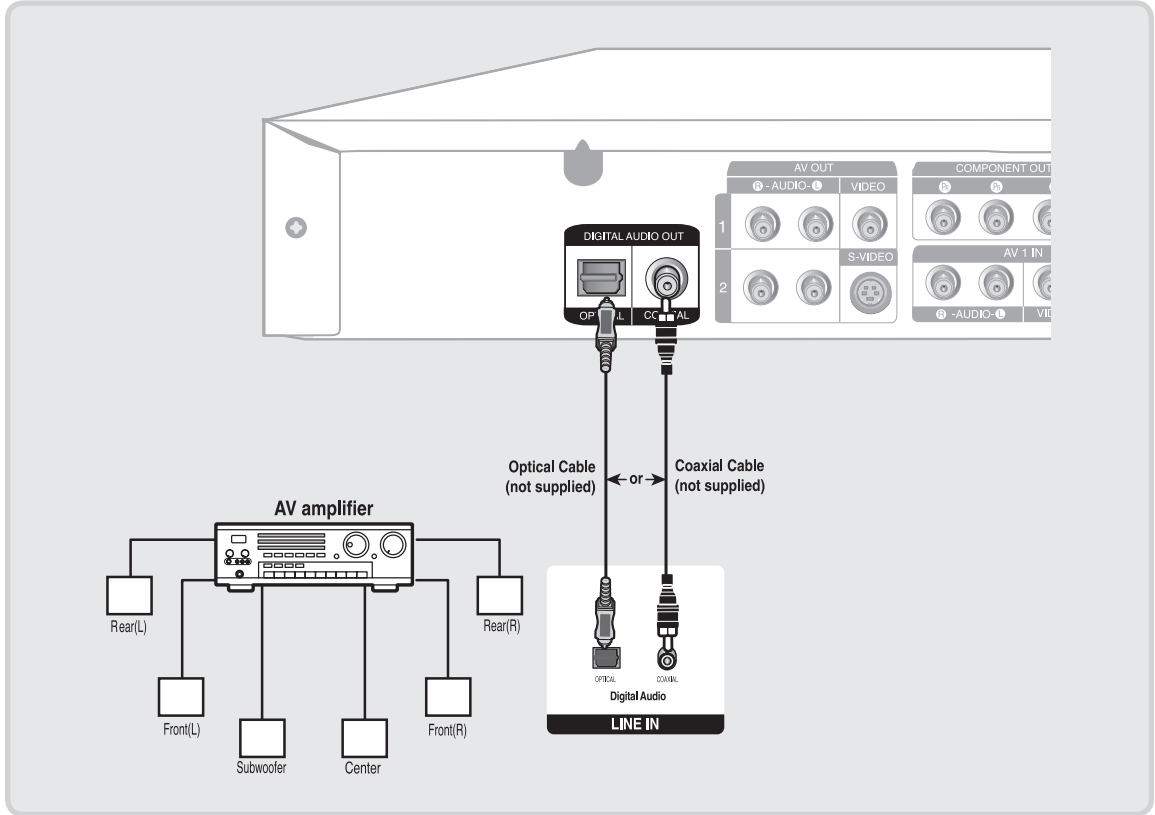

Manufactured under license from Dolby Laboratories. "Dolby" and the double-D symbol are trademarks of Dolby Laboratories.

"DTS" and "DTS Digital Out" are trademarks of DTS, Inc.

Step 4 : Connecting External Devices

This allows you to connect your DVD Recorder to other external devices and view or record their outputs.

Connecting a VCR, Set Top Box(STB) or DVD Player to the AV 1 IN or S-VIDEO IN jacks

Connect the VCR or external device to the AV 1 IN jacks of the DVD Recorder.
You can record from the connected equipment (VCR, STB or DVD Player).

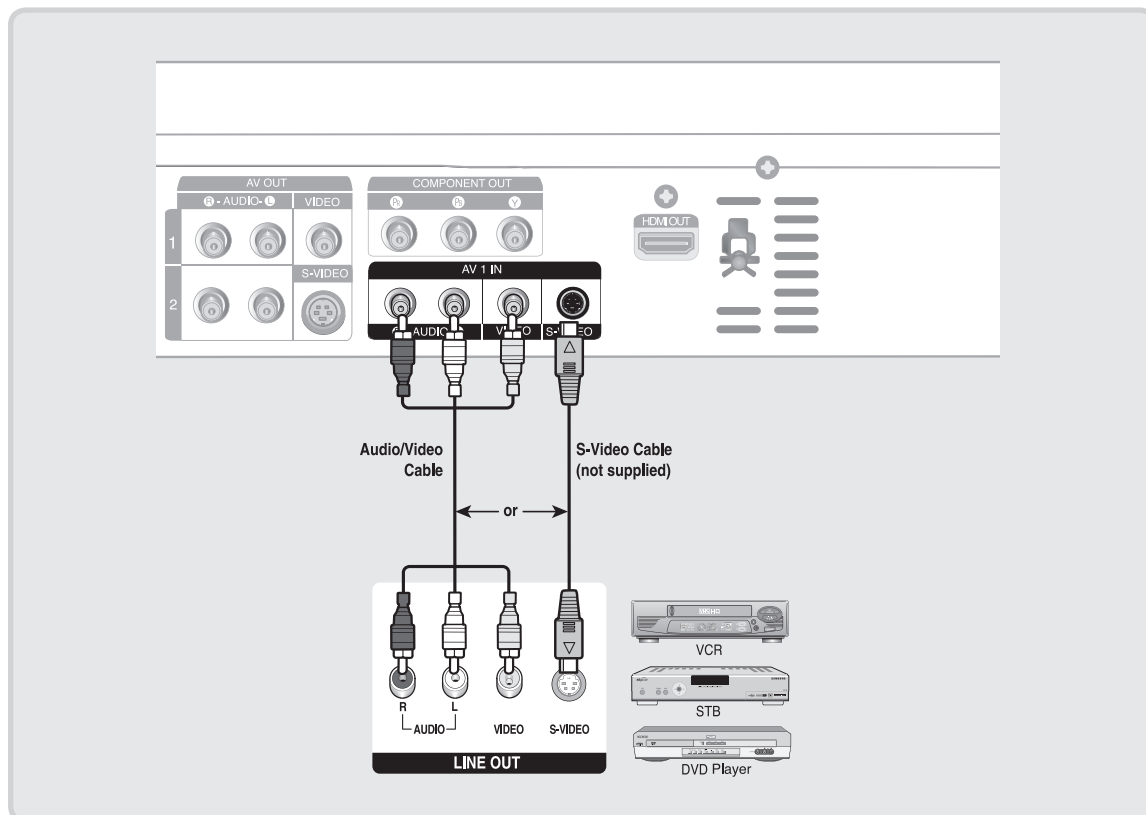

- The DVD-R155 does not have a TV tuner. Recording TV broadcasts is possible via Connection to Cable/Satellite boxes and Multi Channel Video Services.

Connecting a Camcorder

You can record from connected equipment, such as a camcorder by using the AV 2 IN or DV IN jacks on front of the DVD Recorder.

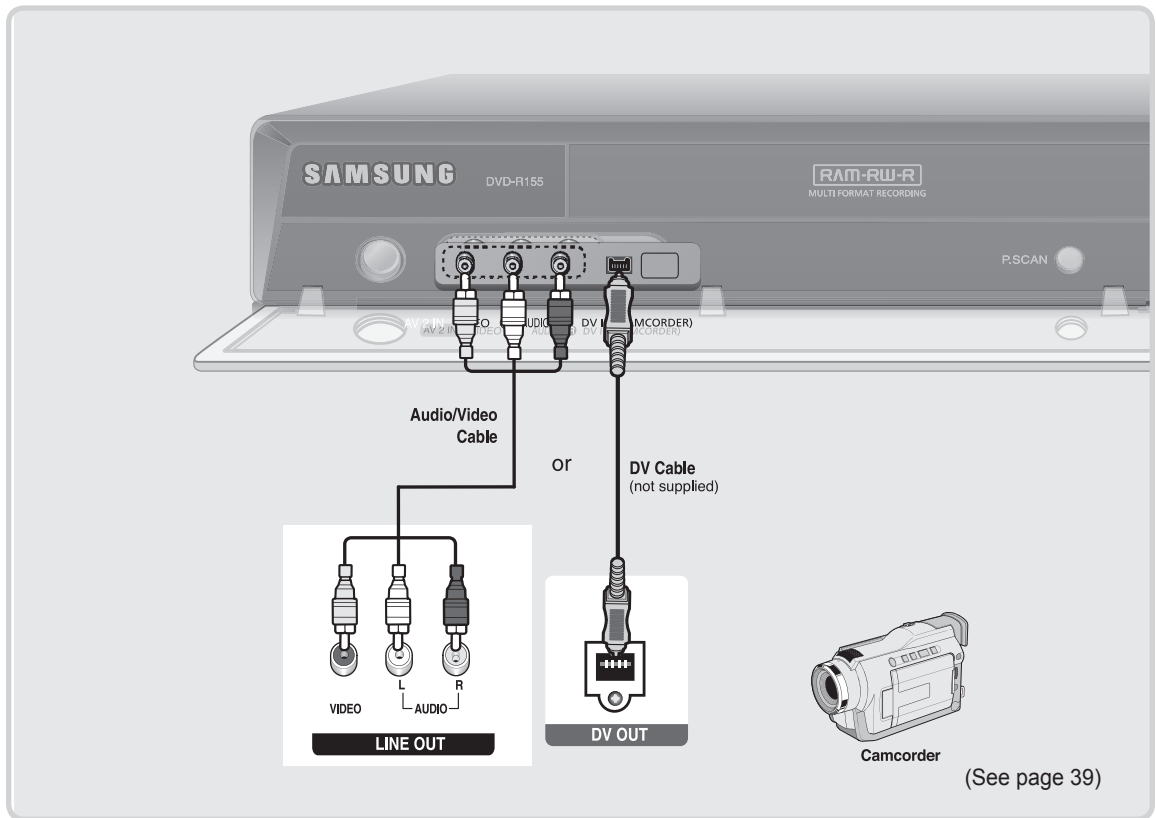

- When an Input source is inserted into AV 2 while watching TV, the Input will be switched to AV 2 automatically.
- If the Input is not selected automatically, press the **INPUT SEL.** button on the remote control to select the DV Input.
- Check your camcorder's owner's manual to see how to use the camcorder in this mode.



System Setup

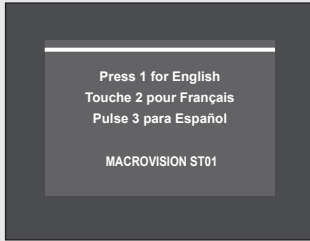

Initial Setup

If you connected an external Audio System, turn on your Audio System and select **AUX, CD or DVD**.
The OSD (On-Screen Display) displayed on the screen may vary depending on conditions such as the disc type and whether the disc has been inserted or not.

OSD Language Setup

After plugging in the recorder, the first time you press the **POWER** button, the screen shown to the left appears.

1. Press the **POWER** button.
2. Press a number button to select the language.



■ If the language for the startup screen is not set, the settings may change whenever you turn the power on or off. Therefore, make sure that you select the language you want to use.

Using the Setup Menu

For ease of use, we recommend that you perform the initial setup before using the product.

1. With the unit in Stop mode/No Disc mode, press the **MENU** button on the remote control.
Menu items differ depending on the disc type.
2. Select Setup using the **▲ ▼** buttons, then press the **ENTER** or **▶** button.
Setup menu will be displayed.

• System

Setup of the General Options.

- CM Skip Time, EP Mode Time, Chapter Creator, Quick Recording, Anynet+(HDMI-CEC)

• Clock Set

- Manual Clock Set

• Language

Setup of the Language Options.

- Audio, Subtitle, Disc Menu, On-Screen Menu

• Audio

Setup of the Audio Options

- Digital Output , DTS, Dynamic Compression

• Video

Setup of the Display Options.

- TV Aspect, Input Level, Black Level, 3D Noise Reduction, HDMI/DVI Resolution

• Parental Control

Setup of the Parental Level

- Allows users to set the level necessary to prevent children from viewing unsuitable movies such as those with violence, adult subject matter, etc.
- Password, Rating Level, Change Password



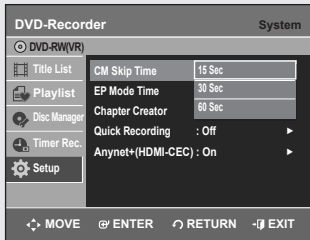

Setting Up the System Options

CM Skip Time Setting

When a program recorded on a DVD-RAM, a DVD-RW, DVD-VIDEO or a DVD-R is played, the unit can be set to automatically skip a portion of the program corresponding to a CM(commercial) Skip Time set by the user.

1. With a disc inserted and the unit in Stop mode, press the **MENU** button on the remote control.
2. Select **Setup** using the **▲▼** buttons, then press the **ENTER** or **▶** button.
You can't use the Setup functions while playing a disc.
3. Select **System** using the **▲▼** buttons, then press the **ENTER** or **▶** button.
System menu will be displayed.
4. Select **CM Skip Time** using the **▲▼** buttons, then press the **ENTER** or **▶** button.
CM Skip Time will be displayed.
5. Select the desired time using the **▲▼** buttons, then press the **ENTER** or **▶** button.
6. If you press the **CM SKIP** button during playback, the section corresponding to the set time is skipped, and then the next section is played.



- CM Skip can be performed only during normal playback.
- When the time set is less than the remaining time of a current title: The next title is played from the beginning.
- When the time set is less than the remaining time of a playlist, the next scene is played.
- CM Skip does not work in still picture mode.
- When a set time is less than the remaining time of a scene, last title, or last track that is currently displayed, a prohibition mark appears.
- CM Skip releases Repeat (including Repeat A-B, Chapter, and Title).
- CM Skip may not operate with some DVD-Video discs.
- DVD+R/DVD+RW discs do not support this function.

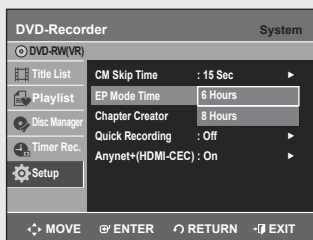

EP Mode Time Setting

You can set the EP (Extended Play) mode's time to 6 or 8 hours.

1. With a disc inserted and the unit in Stop mode, press the **MENU** button on the remote control.
2. Select **Setup** using the **▲ ▼** buttons, then press the **ENTER** or **▶** button.
You can't use the Setup functions while playing a disc.
3. Select **System** using the **▲ ▼** buttons, then press the **ENTER** or **▶** button.
4. Select **desired option** using the **▲ ▼** buttons, then press the **ENTER** or **▶** button.
EP Mode Time will be displayed.
5. Select the desired menu using the **▲ ▼** buttons, then press the **ENTER** or **▶** button.

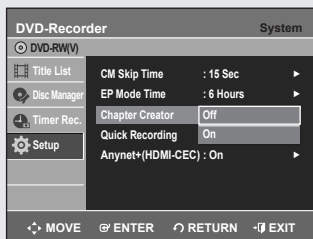

Automatic Chapter Creation

This function works for DVD-RW (Video) and DVD-R discs only.

1. With a disc inserted and the unit in Stop mode, press the **MENU** button on the remote control.
2. Select **Setup** using the **▲ ▼** buttons, then press the **ENTER** or **▶** button.
You can't use the Setup functions while playing a disc.
3. Select **System** using the **▲ ▼** buttons, then press the **ENTER** or **▶** button.
System menu will be displayed.
4. Select **Chapter Creator** using the **▲ ▼** buttons, then press the **ENTER** or **▶** button.
Chapter Creator items will be displayed.
5. Select **On** using the **▲ ▼** buttons, then press the **ENTER** button.
 - **Off** : Select this option when you do not want to create chapters.
 - **On** : Select this option when you want to create chapters.



- Set the chapter creator to on and then start recording. Stopping the recording will automatically create a chapter menu.
- This function only works for normal recording.
 - After the recording has begun, the "Do you want to create the chapter menu after this recording?" message appears for 10 seconds. Select **Yes** or **No**.
 - Selecting **Yes** will create a new chapter menu while selecting **No** will not.
 - A new chapter is created according to the selected recording mode. A chapter will be about 5 minutes long in XP and SP, and about 15 minutes long in LP and EP mode.
- To display the created chapters and finalize the disc, press the **DISC MENU** button. The chapters menu appears.



- The Automatic Chapter Creation function does not work during Timer Recording or when you turn the power off.



Quick Recording Setting

It takes about 10 seconds for a disc to load (initialize) every time you turn on the unit. To bypass this initialization process, you can set the Quick Recording feature to On. This enables you to record immediately without having to wait for the disc to load.

1. With a disc inserted and the unit in Stop mode, press the **MENU** button on the remote control.
2. Select **Setup** using the **▲▼** buttons, then press the **ENTER** or **▶** button.
You can't use the Setup functions while playing a disc.
3. Select **System** using the **▲▼** buttons, then press the **ENTER** or **▶** button.
System menu will be displayed.
4. Select **Quick Recording** using the **▲▼** buttons, then press the **ENTER** or **▶** button.
Quick Recording menu will be displayed.
5. Select **On** using the **▲▼** buttons, then press the **ENTER** or **▶** button.



- The Quick Recording is set to Off as default.

Anynet+(HDMI-CEC)

Anynet+ is a function that can be used to operate the recorder using a Samsung TV remote control, by connecting the DVD Recorder to a SAMSUNG TV using an HDMI Cable. (see page 15) (This is only available with SAMSUNG TVs that support Anynet+.)

1. With the unit in Stop mode/No Disc mode, press the **MENU** button on the remote control.
2. Select **Setup** using the **▲▼** buttons, then press the **ENTER** or **▶** button.
3. Select **System** using the **▲▼** buttons, then press the **ENTER** or **▶** button. The system menu will be displayed.
4. Select **Anynet+(HDMI-CEC)** using the **▲▼** buttons, then press the **ENTER** or **▶** button.
Anynet+(HDMI-CEC) items will be displayed.
5. Select **On** using the **▲▼** buttons, then press the **ENTER** or **▶** button.

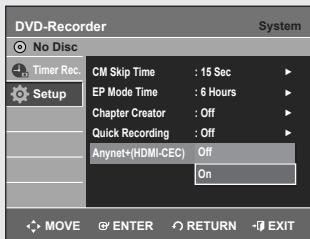

Using Anynet+(HDMI-CEC)

1. Connect the recorder to a Samsung TV with an HDMI cable. (See page 15)
2. Set the Anynet+(HDMI-CEC) to "On" on your DVD Recorder. (see above)
3. Set the Anynet+ function on your TV. (See the TV instruction manual for more information.)
 - You can operate the DVD Recorder by using the TV remote control. (Available TV buttons: **◀▶**, **⏪**, **⏩**, **⏮**, **⏭**, **⏯** and **⏶** buttons, **⓪**~**⓪** button)
 - When you press the **Anynet+** button on the TV's remote control, the OSD to the left will appear.
 - **DVDR Operation** : Same as **ANYKEY** button (**⓪**) on the DVD Recorder remote control.
 - **DVDR Menu** : Same as **MENU** button (**⓪**) on the DVD Recorder remote control.



TV Menu

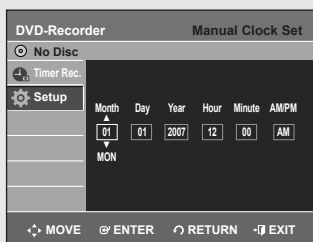

- By pressing the **Play** button of the recorder while watching TV, the TV screen will change to the play screen.
- If you play a DVD when the TV power is off, the TV will power On.
- If you turn the TV off, the DVD Recorder will power off automatically. (When the DVD recorder is recording, it can't be powered off.)
- If you change HDMI to other sources (Composite, Component, RF... etc) on your TV while playing a DVD disc, the DVD Recorder will stop playing. The DVD Recorder may keep playing certain discs based on their content.

Clock Set

This menu is used to set the current time. You must set the time first to use timer recording.

Select the current date and time (**Month, Day, Year, Hour, Minute** and **AM/PM**) using the **▲▼◀▶** or number buttons and then press the **ENTER** button.

When the current time is stored in memory and the set is powered off, the current time will appear in the front panel display.

▲▼ : Sets the value

You can set the value using the number (0~9) buttons.

◀▶ : Moves to items



- The Menus are slightly different depending on whether a disc is inserted or not. The menus described on the next few pages are with no disc in the unit.
- The menus are not available during playback or recording.

Language Setting

If you set the language options in advance, they will come up automatically every time you watch a movie.

1. With the unit in Stop mode/No Disc mode, press the **MENU** button on the remote control.
2. Select **Setup** using the **▲▼** buttons, then press the **ENTER** or **▶** button.
3. Select **Language** using the **▲▼** buttons, then press the **ENTER** or **▶** button.
The language setup menu will be displayed.
4. Select the sub menu (**Audio, Subtitle, Disc Menu, On-Screen Menu**) and press the **ENTER** or **▶** button using the **▲▼** buttons.
 - **Audio** : For the disc audio language.
 - **Subtitle** : For the disc subtitles.
 - **Disc Menu** : For the disc menu contained on the disc.
 - **On-Screen Menu** : For the unit menu of your DVD recorder.
5. Select the desired language using the **▲▼** buttons, then press the **ENTER** or **▶** button.



- If the selected language is not recorded on the disc, the original pre-recorded language is selected.
- The selected language will only appear if it is supported on the disc.

Setting Up the Audio Options

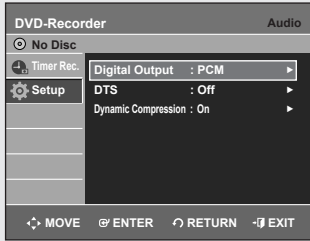

You can connect the DVD-R155 to an external audio amplifier or a Home Theater system.

This allows you to setup the audio device and sound status settings depending on the audio system in use.

1. With the unit in Stop mode/No Disc mode, press the **MENU** button on the remote control.
2. Select **Setup** using the **▲▼** buttons, then press the **ENTER** or **▶** button.
3. Select **Audio** using the **▲▼** buttons, then press the **ENTER** or **▶** button.
4. Select the sub menu(**Digital Output**, **DTS**, **Dynamic Compression**) using the **▲▼** buttons, then press the **ENTER** or **▶** button.

Select the item that matches the audio connection you've selected on pages 20~22.

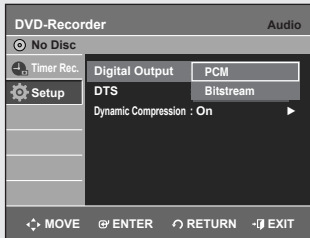

Digital Output

- **PCM** : Converts to PCM(2CH) 48kHz audio. Select PCM if your amplifier system supports stereo and/or Dolby Prologic.
- **Bitstream** : Outputs Bitstream. Select Bitstream if your amplifier system supports multi channel digital audio surround decoding such as Dolby Digital and/or DTS.

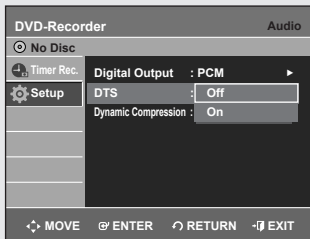

DTS

- **On** : Outputs DTS bitstream. (via Digital Audio Output) Select DTS when connecting to a digital amp with a DTS decoder.
- **Off** : Doesn't output DTS bitstream.
- When a DTS soundtrack is played, sound is not output from the Analog Audio Output.

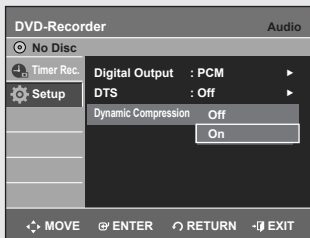

Dynamic Compression

This is only active when a Dolby Digital signal is detected.

- **On** : When movie soundtracks are played at low volume or from small speakers, the system can apply appropriate compression to make low-level content more intelligible and prevent dramatic passages from getting too loud.
 - **Off** : You can enjoy the movie with standard Dynamic Range.
5. Select the desired item(**PCM**, **Bitstream**, **DTS-Off**, **DTS-On**, **Dynamic Compression-Off** or **Dynamic Compression-On**) using the **▲▼** buttons
Then press the **ENTER** or **▶** button.

Video(Display) Setting

This allows you to set up the TV screen settings.

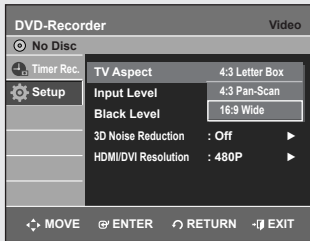

TV Aspect

1. With the unit in Stop mode/No Disc mode, press the **MENU** button.
2. Select **Setup** using the **▲▼** buttons, then press the **ENTER** or **▶** button.
3. Select **Video** using the **▲▼** buttons, then press the **ENTER** or **▶** button.
4. Select **TV Aspect** using the **▲▼** buttons, then press the **ENTER** or **▶** button.
5. Select the desired item (**4:3 Letter Box**, **4:3 Pan-Scan** or **16:9 Wide**) using the **▲▼** buttons.
Then press the **ENTER** or **▶** button.

If you have a 4:3 standard TV

- **4:3 Letter Box** : Select when you want to see the total 16:9 ratio screen DVD supplies, even though you have a TV with a 4:3 ratio screen. Black bars will appear at the top and bottom of the screen.
- **4:3 Pan-Scan** : Select this for a conventional size TV when you want to see the central portion of the 16:9 screen. (Extreme left and right side of movie picture will be cut off.)

If you have a wide screen TV or 4:3 standard TV with a wide-screen mode

- **16:9 Wide** : You can view the full 16:9 picture on your widescreen TV.



Input Level

Adjusts the level of the input signal.

- **Darker** : If you feel the screen is too light and you want to make the screen darker.
- **Lighter** : If you feel the screen is too dark and you want to make the screen lighter.

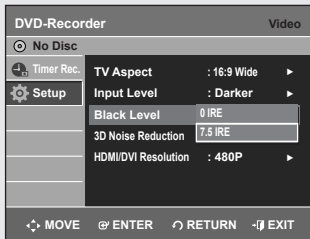

Black Level

Adjusts the black level of the screen.

- **0 IRE** : Select this when you want a darker screen.
- **7.5 IRE** : Select this when you want a lighter screen.



- Black level function is not available in the progressive scan mode.

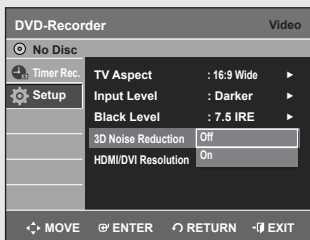

3D Noise Reduction

- **On** : Provides a cleaner picture through noise reduction (for recording).
- **Off** : Normal

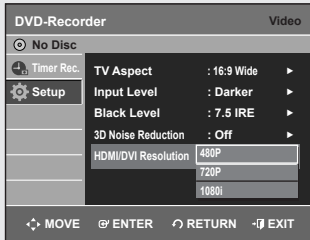

HDMI/DVI Resolution

This setting is used when the unit is connected by HDMI or DVI to Display devices (TV, projector, etc).

- **480p** : 720 x 480
- **720p** : 1280 x 720
- **1080i** : 1920 x 1080
- Connect the DVD-R155 to your TV via HDMI or DVI. Set your TV's input to HDMI or DVI.
- Press the **P.SCAN** button while the unit is in stop mode to select the output resolution.
 - If your TV is connected the HDMI or DVI cable, the output resolution mode changes in the following sequence each time you press the **P.SCAN** button:

→480p → 720p → 1080i. □

- If the DVD Recorder is connected to your TV with Component cables(no HDMI/DVI cable connected), the output resolution mode toggles between 480p/480i.

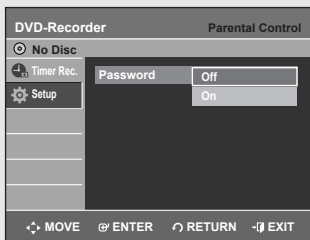

Parental Control



The Parental Control function works in conjunction with DVDs that have been assigned a rating - which helps you control the types of DVDs that your family watches. There are up to 8 rating levels on a disc.

1. With the unit in Stop mode/No Disc mode, press the **MENU** button on the remote control.
2. Select **Setup** using the **▲▼** buttons, then press the **ENTER** or **▶** button.
3. Select **Parental Control** using the **▲▼** buttons, then press the **ENTER** or **▶** button.
4. The first time the Parental Control is accessed, the 'Create the Password' message will be displayed.
Create a 4-digit password using the 0 to 9 buttons on the remote control.
5. The Re-enter Password screen appears to confirm the password.
Enter your password again.
6. Press the **ENTER** or **▶** button, and then select **On** using the **▲▼** buttons.
The Parental Control screen appears.

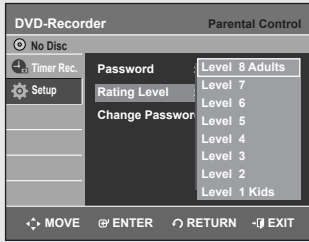

Setting the Rating Level

1. Select **Rating Level** using the ▲ ▼ buttons.
2. Press the **ENTER** or ► button.
3. Select the desired Level you want using the ▲ ▼ buttons, then press the **ENTER** or ► button.
For example, if you select up to Level 6, discs that contain Level 7, 8 will not play. A higher number indicates that the program is intended for adult use only.

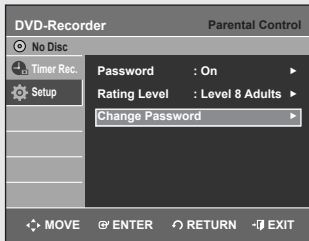

Changing the Password

1. Select **Change Password** using the ▲ ▼ buttons.
2. Press the **ENTER** or ► button.
The "Enter the password" message will be displayed.
3. Enter the 4-digit password using the 0 to 9 buttons on the remote control.
4. The "Confirm the password" message will be displayed.
Enter your password again using the 0 to 9 buttons on the remote control.



- If you forgot your password, remove the disc. Press the **INPUT SEL.** and **REC MODE** buttons on the front panel of the DVD Recorder simultaneously for 5 seconds or more when the power is on. All settings including the password will revert to the factory settings.



Recording

This section explains various DVD recording methods.

This unit can record on various types of discs. Before recording, read the following instructions and select the disc type according to your preference.

Recordable discs

This recorder can record on the following discs.

| | | |
|---|---|---|
| DVD-RAM | DVD-RW | DVD-R |
|  |  |  |

- DVD-RWs and DVD-RAMs are rewritable.
- DVD-Rs are non-rewritable

Compatibility between Samsung and Other manufacturer's Recorders

| Disc Types | Recording format | Recording Device | Finalizing | Additional Recording in Samsung Recorder |
|---------------|------------------|------------------|----------------|--|
| DVD-RAM | VR Mode | Samsung | X | Recordable |
| | | Other Company | X | Recordable |
| DVD-RW | VR Mode | Samsung | finalized | Not recordable |
| | | | not finalized | Recordable |
| | | Other Company | finalized | Not recordable |
| | | | not finalized | Recordable |
| | V Mode | Samsung | finalized | Not recordable |
| | | | not finalized | Recordable |
| Other Company | V Mode | finalized | Not recordable | |
| | | not finalized | Not recordable | |
| DVD-R | V Mode | Samsung | finalized | Not recordable |
| | | | not finalized | Recordable |
| | | Other Company | finalized | Not recordable |
| | | | not finalized | Not recordable |

- 
 - Finalize
 - This closes the DVD-R/-RW and no additional recording can be done.
 - Unfinalize
 - This allows additional recording on a DVD-RW disc originally recorded on the DVD-R155.
 - A DVD-RW disc that has been recorded by DAO(Disc At once) in a PC cannot be unfinalized.
 - A DVD-RW disc that has been recorded in Video Mode of another manufacturer's recorder cannot be unfinalized.
 - A DVD-R disc cannot be unfinalized.

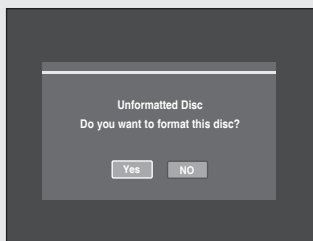
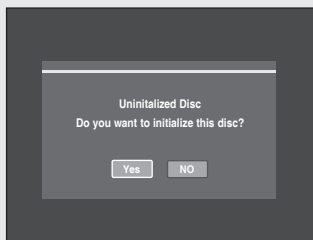
DVD-RAM**DVD-RW**

Recording Formats

Since available functions differ depending on the disc type, select a disc that best fits your preferences.

When you insert an unused disc, the following message appears.

- DVD-RAM : Use after formatting the disc.
- DVD-RW : Use after initializing the disc.
You can change the mode of DVD-RW disc. Refer to Formatting a Disc on page 65.
- DVD-R : Formatting disc is unnecessary.

DVD-RW(Video mode)/-R

- Chapters will be created automatically when you finalize recording on DVD-R/DVD-RW discs in Video mode.
- Simple editing (erasing titles/changing title name).

DVD-RAM/-RW(VR mode)

- This mode involves multiple editing functions (such as deletion of the whole title, partial deletion of a title, etc.).
- Various editing options using a created Playlist.



- You can initialize discs automatically using EZ REC MODE. (See page 44)

Recording Mode

Select one of four record modes by pressing the REC MODE button repeatedly for the desired recording time and picture quality while the unit is in Stop mode.

In general, picture quality improves as the recording time decreases. In FR mode, the most suitable record mode is selected automatically according to the remaining time on the disc and the length of the timer recording set.

You can select only one mode from XP, SP, LP and EP for timer recording.

| Mode | Characteristic | Recording Times Data Rates |
|-------------------------------|--|--|
| XP (high quality mode) | Select when the video quality is important. | Approx. 1 hour about 8 Mbps |
| SP (standard quality mode) | Select to record in standard quality. | Approx. 2 hours about 4 Mbps |
| LP (long recording mode) | Select when a long recording time is required. | Approx. 4 hours about 2 Mbps |
| EP (extended mode) | Select when a longer recording time is required. | Approx. 6 hours/ about 1.2 Mbps Approx. 8 hours/ about 0.8 Mbps |
| FR (Flexible Recording) | For timer recording only see page 42. | Approx 1 to 8 hours Approx 0.8 to 8Mbps |

- The dual layer DVD-Rs have approximately double the capacity of single layer DVD-Rs. (See page 45.)

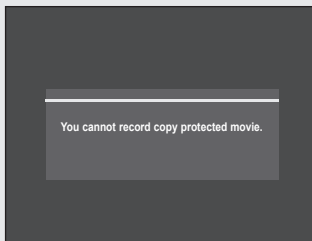

Unrecordable Video

Videos with copy protection cannot be recorded on this DVD Recorder. When the DVD Recorder receives a copy guard signal while recording, recording stops and the following message appears on the screen.

Concerning Copy Control Signals

TV broadcasts that contain copy control signals may have one of the following three signal types, COPY-Free, Copy-Once and Copy-Never. If you want to record a copy-once type program, use a DVD-RW disc with CPRM in VR Mode. You can also use DVD-RAM discs.
('O' : supported, '-' : not supported)

| Signal type Media | Copy-Free | Copy-Once | Copy-Never |
|--|-----------|-----------|------------|
| DVD-RAM (Ver.2.0) | O | O* | - |
| DVD-RW (Ver.1.1) | O | - | - |
| DVD-RW (Ver.1.1) with CPRM VR mode | O | O* | - |
| DVD-R | O | - | - |

When a "Copy Once" recording has been made, recording cannot be done anymore.

*compatible with CPRM.

◆ Content Protection for Recordable Media (CPRM)

CPRM is a mechanism that ties a recording to the media on which it is recorded. It is supported by some DVD recorders, but not by many DVD players. Each blank recordable DVD has a unique 64-bit media ID etched in the BCA(Burst Cutting Area). When protected content is recorded onto the disc, it can be encrypted with a 56-bit C2 (Cryptomeria) cipher derived from the media ID.

During playback, the ID is read from the BCA and used to generate a key to decrypt the contents of the disc. If the contents of the disc are copied to other media, the ID will be absent or wrong and the data will not be decryptable.

About the INFO Button

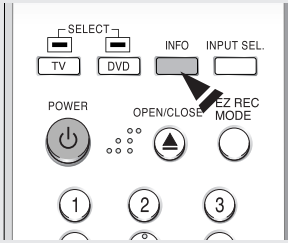

- ◆ *The INFO function allows you to view the current status and progress of playback and recording. When recording on a used disc, make sure that there is enough disc space for recording.*

| DVD-RW(VR) | | Disc Info |
|-----------------|---------------|-----------|
| Disc Name | Disc | |
| Total Title | 15 | |
| Total Playlist | 1 | |
| Recordable Time | 02: 12 SP | |
| Protection | Not Protected | |
| Screen | AV1 | |
| JAN 01 2007 MON | | 12:00 AM |

- ◆ **Press the INFO button.**

The disc information display window appears.

1. Disc Type
2. Current information display status
3. Disc Name
4. Total Title : Total number of titles
5. Total Playlist : Total number of Playlists
6. Recordable Time : The longest continuous recording time in each of the record modes(approximate)
7. Date : Current date
8. Time : Current time



- Items in the display differ depending on the disc type or the recording format.
- With DVD-RAMs or DVD-RWs, you can free up disc space by erasing titles.
- Press the **INFO** button again with the unit in playback or recording, then you can check the current status.



Recording from External Equipment



Before you start

◆ Check that the disc has enough available space for the recording. Adjust the recording mode.

1. Press the **OPEN/CLOSE** button and place a recordable disc on the disc tray.
2. Press the **OPEN/CLOSE** button to close disc tray. Wait until "LOAD" disappears from the front panel display
3. Press the **INPUT SEL.** button to select the input source according to the connection you made. The front panel display changes in the following sequence:

→ AV1 → AV2 → DV

4. Press the **REC MODE** button repeatedly, to select the recording speed(quality).

→ SP → LP → EP → XP

5. Press the **REC** button.

To pause recording

Press the **PLAY/PAUSE** (⏮) button to pause recording in progress. Press the **PLAY/PAUSE** (⏭) button again to resume recording.

To stop recording

Press the **STOP** (⏹) button to stop or finish recording in progress.

- When using DVD-RAM/DVD-RW/DVD-R discs, the message 'Updating the information of disc. Please wait for a moment.' is displayed.



- You can not change the recording mode and input source during recording.
- Recording will stop automatically if there is no free space left for recording.
- Up to 99 titles can be recorded onto a DVD-RAM/-RW/-R disc.
- Recording will stop automatically if a copy protected image is selected.
- If you are using a Cable Box(no antenna), you cannot watch a different cable TV program from the one you're recording.
- DVD-RAM/DVD-RW discs must be formatted before starting to record. Most new discs are sold unformatted.
- Do not use DVD-R authoring discs with this unit.

Copying from a Camcorder

You may control a Digital Camcorder using the IEEE1394 (DV) interface.



Before you start

Check that the disc has enough available space for the recording. Adjust the record mode. See page 24 to see how to connect the camcorder to your DVD recorder.

1. Press the **OPEN/CLOSE** button, and place a recordable disc on the disc tray.
2. Press the **OPEN/CLOSE** button to close the disc tray. Wait until "LOAD" disappears from the front panel display.
3. Press the **REC MODE** button repeatedly to select the recording speed(quality).
→ SP → LP → EP → XP
4. Press the **INPUT SEL.** button to select **DV**.
If the input is set to **DV**, a playback/record menu that enables control of the digital camcorder appears on the top of the screen.
5. Select the **PLAY** (▶) icon on the upper part of the screen to playback the camcorder and find the starting position to copy.
6. To start recording, select **REC** (●) icon in the top side of the screen using the ◀ ▶ buttons, then press the **ENTER** button.

To stop recording

Press the **STOP** (⊖) button to stop or finish recording in progress.

- When using DVD-RAM/DVD-RW/DVD-R discs, the message 'Updating the information of disc. Please wait for a moment' is displayed.



- You can not change the record mode and input source while recording.
- Recording will stop automatically if there is no free space left for recording.
- Up to 99 titles can be recorded onto a DVD-RAM/-RW/-R disc.
- DVD-RAM/DVD-RW discs must be formatted before starting to record.
Most new discs are sold unformatted.
- Do not use DVD-R authoring discs with this unit.
- To access on-screen controls during recording, press the ◀ or ▶ buttons.
- When copying from a camcorder and the end of the tape is reached (no Video), the screen may turn blue or purple.

Making a One Touch Recording (OTR)



You can set the DVD Recorder to record in preset increments by pressing the REC button repeatedly.

1. If you want to record from a connected external component, press the **INPUT SEL.** button to select an appropriate external input(AV1, AV 2 or DV).
2. Press the **REC** button to start recording.
3. Press the **REC** button to adjust the recording time.

→ 0:30 → 1:00 → 1:30 → 2:00 → 3:00 → 4:00 → off



- The timer counter decreases to 0:00, then the DVD Recorder stops recording.
After finishing recording, the DVD Recorder will turn off automatically.

To stop recording

Press the **STOP** (⏻) button. The message "Press STOP button once more to cancel Timer Record." is displayed.

Press the **STOP** (⏻) button again to stop recording.

Setting a Timer Recording

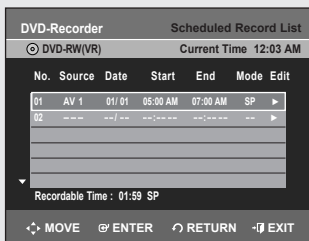
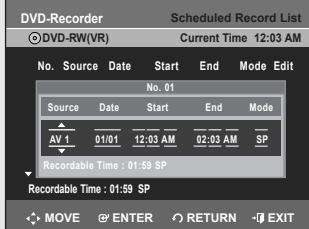
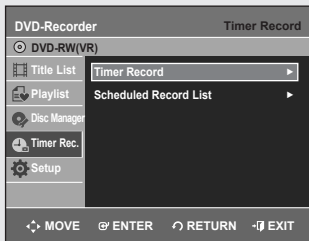

You need to set the Clock (Setup – Clock Set) before proceeding with a timer recording. (See page 29)

1. Press the **OPEN/CLOSE** button, and place a recordable disc on the disc tray.
 2. Press the **OPEN/CLOSE** button to close the disc tray. Wait until “LOAD” disappears from the front panel display. If an unused DVD-RW disc is inserted, a message asking whether to initialize the disc or not will appear. (See page 35)
 3. Press the **MENU** button in Stop mode. You can also set a timer recording via the **TIMER** button.
 4. Press the **▲▼** buttons to select **Timer Rec.**, and then press the **ENTER** or **▶** button.
 5. Press the **▲▼** buttons to select **Timer Record**, and then press the **ENTER** or **▶** button. The Timer Record Input items are displayed.
 6. Fill in the items using the **▲▼◀▶** buttons.
 - ◀▶ : Moves to the previous/next item,
 - ▲▼ or 0~9 : To set or change items in the Scheduled Record List Menu.
 - **Source**: Select the video input source (AV 1, AV 2) you want to make a timer recording of.
 - **Date**: Date that the timer recording starts
 - There are three options when setting the date. see below:
 - ① To make a recording on a specific date, press the **▲▼** or number buttons until the date you want appears.
 - ② To make a recording at the same time every day (MON-FRI), press the **▲▼** buttons until MON-FRI appears.
 - ③ To make a recording on a specific day of the week (Every SUN - Every SAT), press the **▲▼** buttons until Sun's...Sat's appears.
 - **Start/End Time**: Start and end time of the timer recording
 - **Mode (Record mode)**
 - XP : Approx. 1 hour
 - SP : Approx. 2 hours
 - LP : Approx. 4 hours
 - EP : Approx. 6 hours or 8 hours
 - FR : See page 42.
- When you are recording at EP mode on a DVD-RW(V)-R disc, it may not record the full 6 or 8 hours because the unit uses the VBR(Variable Bit Rate) ENCODING system. For example, if you record a Program with a lot of action, it uses a higher bit rate which in turn consumes more disc memory.
7. Press the **ENTER** button.
 - (⊖) and Timer Set will appear on the front panel display. This means that a timer recording is set.
 - Recording is automatically performed when the set time is reached.

**■ If the timer settings overlap**

The first program has priority. After recording of the first program is complete, the second program starts being recorded.

- The timer recording may be different from the actual set time depending on the disc and the timer recording status (for example, recording times overlapping, or if the previous recording ends within 3 minutes of the start of the next recording.).
-  will start blinking if Timer Recording is not ready to start.

Flexible Recording (for Timer Recording only)



In FR mode, the most suitable recording mode is selected automatically, according to the remaining time on the disc and the length of the timer recording set.

The FR mode recording setup is the same as the Timer Recording setup. When setting the Rec mode in step 6, select FR Mode. (See page 41)

Editing the Scheduled Record List



You can change timer record settings using the scheduled record list menu.

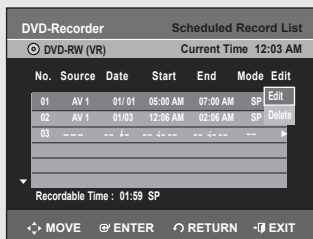

1. Press the **MENU** button in **STOP** mode.
2. Press the **▲▼** buttons to select **Timer Rec.**, and then press the **ENTER** or **▶** button.
3. Press the **▲▼** buttons to select **Scheduled Record List**, and then press the **ENTER** or **▶** button.
4. Press the **▲▼** buttons to select the number of the Scheduled Record List you want to edit, and then press the **ENTER** or **▶** button. The Edit and Delete items are displayed.
5. Press the **▲▼** buttons to select **Edit**, and then press the **ENTER** or **▶** button. The Timer Record Input item is displayed. Edit the items you want to modify. See the Timer Record section for more information on Timer Record Input items. (See page 41)
6. Move through the items with the **◀▶** buttons and change the settings with **▲▼** or number buttons and press the **ENTER** button.
7. Press the **MENU** button after the operation is finished. The menu screen will disappear.

Deleting the Scheduled Record List

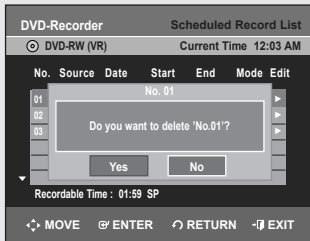

You can delete the timer record list using the scheduled record list menu.

1. Press the **MENU** button in Stop mode.
2. Press the **▲▼** buttons to select **Timer Rec.**, and then press the **ENTER** or **▶** button.
3. Press the **▲▼** buttons to select **Scheduled Record List**, and then press the **ENTER** or **▶** button.
4. Press the **▲▼** buttons to select the number of the timer recording you want to delete, and then press the **ENTER** or **▶** button. The Edit and Delete items are displayed.
5. Press the **▲▼** buttons to select **Delete**, and then press the **ENTER** or **▶** button.
6. Press the **◀▶** buttons to select **Yes**, and then press the **ENTER** button. The selected entry will be deleted from the list.



- You can not delete programs that are currently being recorded.

Recording the Scheduled Record List

When the start time in the Scheduled Record List is reached while the unit is powered off, the unit will automatically power on and start recording.

1. When the scheduled recording is operating, the program being recorded will not display on TV.
 - Power on the TV using the TV remote control.
 - Power off the TV using the TV remote control if you don't want to see the program being recorded.

To stop recording

Press the **STOP** (⏏) button. The message "Press STOP button once more to cancel Timer Record." is displayed.

Press the **STOP** (⏏) button again to stop recording.



- If a copy protection signal is received during recording, recording will stop.
- If there is no free disc space or the disc is not recordable, recording will not operate. (You can record after replacing the disc.)

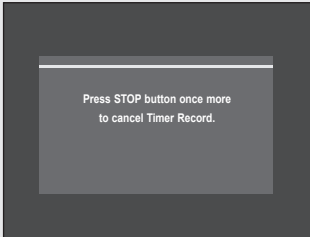

Press STOP button once more
to cancel Timer Record.

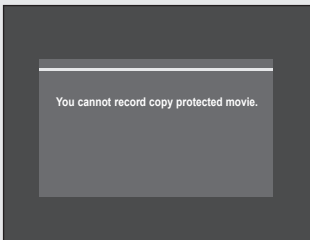

You cannot record copy protected movie.

EZ REC MODE

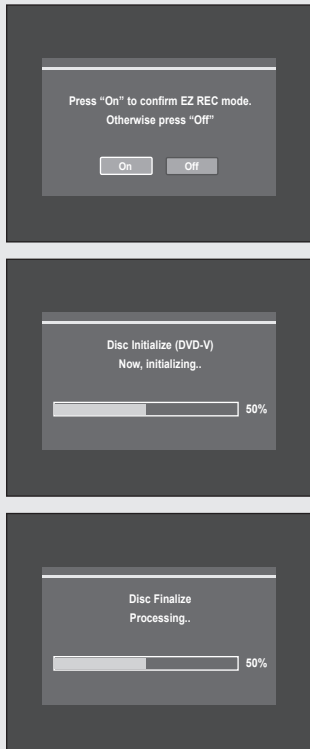

This function allows you Initialize and Finalize a disc automatically.

1. With the unit in Stop/No Disc mode, press the **EZ REC MODE** button on the remote control.
2. Press the ◀ ▶ buttons to select **On**, and then press the **ENTER** button.
The EZ REC MODE is set up.
3. Insert a disc.
If the disc is new, it will initialize automatically.
4. Press the **REC** button.
5. EZ REC MODE will Automatically Finalize the disc under the following conditions.

- When you press the **OPEN/CLOSE** button on your DVD Recorder after recording on at least 30% of the disc. The tray will open after the disc has been finalized.
- When the disc is full, it will finalize automatically and the Recorder will remain in stop mode.
- When you make a timer recording and it occupies at least 30% of the disc, the disc will finalize automatically and the Recorder will power off. Please note that auto finalization will not work if the Recorder has more than one Timer Recording set in the Scheduled Record List.



- If you insert a new DVD-RW disc, it will be formatted in V mode after auto initializing.
- If you select off, you must initialize (see page 35) and finalize the disc manually in the Disc Manager menu.(see page 66)
- The length of the Recording is different according to recording mode. (see page 35)



Playback

This section introduces basic playback functions and playback by disc type.

Read the following information before playing a disc.

Region code (DVD-Video only)



Both the DVD recorder and the discs are coded by region. These regional codes must match in order for the disc to play. If the codes do not match, the disc will not play. The Region Number for this recorder is described on the rear panel of the recorder.

Logos of Discs that can be played

| | |
|---|--------------------------------------|
| DOLBY DIGITAL Dolby Digital | dts Digital Out DTS |
| DIGITAL SOUND Digital Audio | STEREO Stereo |
| NTSC NTSC broadcast system in U.S.A, Canada, Korea, Japan, etc. | MP3 MP3 |

Disc types that can be played

| Disc Types | Disc Logo | Recorded content | Disc Shape | Max. Playing Time |
|------------|-----------|------------------|--------------------------|--|
| DVD-VIDEO | | VIDEO AUDIO | Single sided(5") | 240min |
| | | | Double sided(5") | 480min |
| | | | Single sided(3.5") | 80min |
| | | | Double sided(3.5") | 160min |
| AUDIO-CD | | AUDIO | Single sided(5") | 74min |
| | | | Single sided(3.5") | 20min |
| JPEG | | JPEG Images | Single sided(5") | - |
| | | | Single sided(3.5") | - |
| MP3 | | MP3 Audio | Single sided(5") | - |
| | | | Single sided(3.5") | - |
| DVD-RAM | | VIDEO AUDIO | Single sided(5") (4.7GB) | 1hr (XP: Excellent Quality) 2hrs (SP: Standard Quality) 4hrs (LP: Long Playback) 6 or 8hrs (EP: Extended) |
| | | | Double sided(5") (9.4GB) | 2hr (XP: Excellent Quality) 4hrs (SP: Standard Quality) 8hrs (LP: Long Playback) 12 or 16hrs (EP: Extended) |
| DVD-RW | | VIDEO AUDIO | 5" (4.7GB) | 1hr (XP: Excellent Quality) 2hrs (SP: Standard Quality) 4hrs (LP: Long Playback) 6 or 8hrs (EP: Extended) |
| DVD-R | | VIDEO AUDIO | Single Layer(5") (4.7GB) | 1hr (XP: Excellent Quality) 2hrs (SP: Standard Quality) 4hrs (LP: Long Playback) 6 or 8hrs (EP: Extended) |
| | | | Dual Layer(5") (8.5GB) | 2hr (XP: Excellent Quality) 4hrs (SP: Standard Quality) 8hrs (LP: Long Playback) 11 or 15hrs (EP: Extended) |
| DVD+RW | | VIDEO AUDIO | 5" (4.7GB) | 1hr (XP: Excellent Quality) 2hrs (SP: Standard Quality) 4hrs (LP: Long Playback) 6 or 8hrs (EP: Extended) |
| DVD+R | | VIDEO AUDIO | Single Layer(5") (4.7GB) | 1hr (XP: Excellent Quality) 2hrs (SP: Standard Quality) 4hrs (LP: Long Playback) 6 or 8hrs (EP: Extended) |
| | | | Dual Layer(5") (8.5GB) | 2hr (XP: Excellent Quality) 4hrs (SP: Standard Quality) 8hrs (LP: Long Playback) 11 or 15hrs (EP: Extended) |

Discs That Cannot be Played

- DVD-Video with a region number other than “1” or “ALL”
- 5” 2.6 GB and 5.2 GB DVD-RAM
- 3.9 GB DVD-R Disc for Authoring.
- A DVD±R/DVD-RW(V) disc which has been recorded and not finalized in a different manufacturer’s recorder.
- PALdiscs
- DVD-ROM/PD/MV-Disc, etc.
- Video CD/CVD/SVCD/CD-ROM/CDV/CD-G/CD-I
- MPEG4 Discs.



- This DVD recorder can only operate with discs that are compatible with DVD-RAM Standard Version 2.0.
 - Playback and/or recording may not work for some types of discs, or when specific operations, such as angle change and aspect ratio adjustment, are being performed. Information about the discs is written in detail on the box. Please refer to this if necessary.
 - Do not allow the disc to become dirty or scratched. Fingerprints, dirt, dust, scratches or deposits of cigarette smoke on the recording surface may make it impossible to use the disc for recording.
 - DVD-RAM/±RW/±R discs may not be able to play on some DVD players, depending on the player, disc and the condition of the recording.
 - Discs with PAL programs recorded on them can not be recorded on using this product.

Playing a Disc

1. Press the **OPEN/CLOSE** button.
The tray opens.
2. Place a disc gently into the tray with the disc’s label facing up.
For DVD-RAM discs, insert the printed side facing up.
3. Press the **OPEN/CLOSE** button to close the disc tray.
 - Your DVD Recorder closes the disc tray and loads the disc automatically.
 - When the recorder is powered on and a disc is in the tray, the unit will be activated and wait in Stop mode.
 - Press the **PLAY** (▶) button to start playback.
 - When the unit is powered off and there is a disc in the unit, pressing the **PLAY** (▶) button will power on the unit and play the disc automatically.
4. Press the **STOP** (⏏) button to stop playback.



- When you stop playing the disc, the recorder remembers where you stopped. When you press the PLAY button again, it will pick up where you left off. (Unless the disc is removed, the recorder is unplugged, or if you do not press the STOP button twice.) This function is only applicable to DVD-VIDEO, DVD-RAM, DVD±RW, DVD±R or audio CDs (CD-DA).



- Do not move your DVD recorder while playing, as this may cause damage to the disc.
 - Make sure to press the OPEN/CLOSE button to open or close the disc tray.
 - Do not push the disc tray while it is being opened or closed, as this may cause a product malfunction.
 - Do not place foreign materials on or in the disc tray.
 - Some functions may perform differently or be disabled depending on the disc type. If this occurs, refer to the instructions written on the disc case.
 - Be especially careful that children’s fingers are not caught between the disc tray and the tray chassis when it closes.
 - You must only insert one DVD disc at a time. Inserting two or more discs will not allow playback and may cause damage to the DVD player.

Using the Disc Menu & Title Menu

Some discs contain a dedicated menu system that allow you to select special functions for the title, such as chapters, audio track, subtitles, film previews, information on characters, etc.

For DVD-VIDEO Discs



Disc Menu : Press the **DISC MENU** button to enter the disc's menu.

- Move to the setup menu related to the playback operation.
- You can select the audio language and the subtitles provided by the disc.

Title Menu : Press the **TITLE MENU** button to move to the title menu of the disc.

- Use this button if the disc contains more than one title. Some types of discs may not support the title menu function.

For DVD-RAM/DVD±RW/±R Discs



Title List : Press the **TITLE LIST** button. The Title List is simply a list of titles on a disc. If a title is deleted, that title cannot be played again.

PLAY LIST : Press the **PLAY LIST** button. A playlist is a custom-made list of titles. When one playlist is played, only the titles within the playlist will play and then stop. Even if that playlist is deleted, the original recording will not be deleted. (only VR mode)

Using the Playback Related Buttons

Searching through a Chapter or Track



| | |
|--|---|
| DVD-VIDEO/ DVD-RAM/ DVD±RW/DVD±R | ▶▶ Fast 1(X 2) → ▶▶ Fast 2(X 4) → ▶▶ Fast 3(X 8) → ▶▶ Fast 4(X16) → ▶▶ Fast 5(X 32) → ▶▶ Fast 6(X128) → ▶▶ Fast 1(X 2) |
| AUDIO CD (CDDA) | ▶▶ Fast ×2 → ▶▶ Fast ×4 → ▶▶ Fast ×8 → ▶▶ Fast ×2 |

During playback, press the **SEARCH**(⏮ ⏭) button on the remote control.

- You can scan the program in reverse.
- Press and hold the **SEARCH**(⏮ ⏭) button, playback is done at the default speed of fast 2.
- If you release the **SEARCH**(⏮ ⏭) button, playback is performed at a normal speed.(Except CD-DA)
- To return to normal playback speed, press the **PLAY**(⏪) button.





- No sound is heard during Scan(Search) mode except fast playback (1.7X speed) mode.
- For CD(CD-DA), You can hear sound during Scan mode.
- The speed marked while scanning may be different from the actual playback speed.

Searching Chapters or Tracks

During playback, press the **SKIP**(⏮ ⏭) button on the remote control.

- If you press the **SKIP**(⏮) button, it moves to the beginning of the chapter or track or marker (DVD-RAM,DVD-RW(VR mode).) Pressing the button once again within 3 seconds returns to the beginning of the previous chapter or track or marker (DVD-RAM, DVD-RW(VR mode).)
- If you press the **SKIP**(⏭) button, it moves to the next chapter or title or marker (DVD-RAM,DVD-RW (VR mode).)

Slow Motion Play



In Pause mode, press the **SEARCH**(🔍) button on the remote control.

- If you press the **SEARCH**(🔍) button,

▶▶ Slow 1 → ▶▶ Slow 2 → ▶▶ Slow 3 ◀

- If you press the **SEARCH**(🔍) button,

◀◀ Slow 1 → ◀◀ Slow 2 → ◀◀ Slow 3 ▶

- Press and hold the **SEARCH**(🔍) button during pause, and the disc will play slowly at a 1/2 speed. If the button is released, the pause operation will resume.
- To return to normal speed playback, press the **PLAY**(⏪) button.



- The speed marked in this function may be different from the actual playback speed.

Step Motion Play



Press the **STEP**(⏮ ⏭) button on the remote control in still mode.

- Each time the button is pressed, a new frame will appear.
If you press the STEP(⏮) **button**, the previous frame will be activated.
If you press the STEP(⏭) **button**, the next frame will be activated.
- To return to normal speed playback, press the **PLAY**(⏪) button.

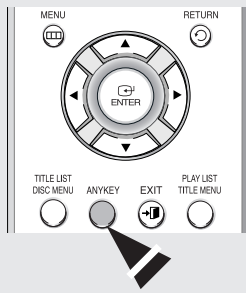

Using the ANYKEY Button

The **ANYKEY** function allows you to easily search for a desired scene by accessing title, chapter, track, and time. You can also change the subtitle and audio settings and set some features including Repeat, Angle, and Zoom.

Moving to a Desired Scene Directly



If you want to move to a certain title, chapter or time use this function.

1. Press the **ANYKEY** button during playback.
2. Press the **▲▼** buttons to select the Title, Chapter or Time.
3. Press the **◀▶** buttons or number (0~9) buttons to select the desired scene and then press the **ENTER** button.
In case of searching a time, Enter the time in the sequence of hours, minutes, seconds using the number buttons. **◀▶** are not available.



- The Time Search function does not operate with some discs.
- To make the screen disappear, press the **ANYKEY** again.

Playing Repeatedly

1. Press the **ANYKEY** button during playback.
2. Press the **▲▼** buttons to select **Repeat** and press the **◀▶** buttons to select the **Title** or **Chapter** you want to play repeatedly.
3. Press the **ENTER** button.



- DVD-RAM, DVD-RW(VR mode), unfinalized DVD±R and unfinalized DVD-RW (Video mode) discs do not repeat a chapter.

Playing a Certain Section Repeatedly



1. Press the **ANYKEY** button during playback.
2. Press the **▲▼** buttons to select **Repeat** and press the **▶** button to select **A-B**.
3. Press the **ENTER** button.
4. Press the **ENTER** button at the point where you want the repeat play to start (A) and press it again at the point where you want the repeat play to stop (B).
Repeat playback of the A-B section starts.



- If you set point (B) before five seconds has elapsed, the prohibition mark (⊘) will appear.
- You can also activate Normal Playback by pressing the **CANCEL** button.
- Audio CDs(CD-DA) and MP3 discs do not support the Repeat A-B function.



Selecting the Subtitle



(VR mode)

Subtitle languages may not work depending on the disc type. This is only available during playback.

1. Press the **ANYKEY** button during playback.
2. Press the **▲▼** buttons to select **Subtitle** and press the **◀▶** buttons to select the desired subtitle language.



- If the subtitles overlap, disable the caption function on your TV.
- Some discs allow you to select the language for the disc menu only.
- To make the screen disappear, press the **ANYKEY** again.

Selecting the Audio language



(VR mode)

Audio languages may not work depending on the disc type. This is only available during playback.

1. Press the **ANYKEY** button during playback.
2. Press the **▲▼** buttons to select **Audio** and press the **◀▶** buttons to select the desired audio language.



- Audio languages may be different because they are disc-specific.
- Some discs allow you to select the audio language for the disc menu only.
- To make the screen disappear, press the **ANYKEY** again.



Using One Touch button

By pressing the audio button, you can access the Audio function directly.

Changing the Camera Angle



When a DVD-VIDEO contains multiple angles of a particular scene, you can select the Angle function.

This is only available during playback.

If the disc contains multiple angles, the ANGLE mark appears on the screen.

1. Press the **ANYKEY** button during playback.
2. Press the **▲▼** buttons to select **Angle** and press the **◀▶** buttons or number(0~9) buttons to select the desired angle.



- This function is disc-dependent, and may not work all DVDs.
- This function does not work when a DVD has not been recorded with a multicamera angle system.
- To make the screen disappear, press the **ANYKEY** again.



Zooming-In



1. Press the **ANYKEY** button during playback or pause.
2. Press the **▲▼** buttons to select **Zoom**, and then press the **ENTER** button.
(**Ⓚ**) will be displayed.
3. Press the **▲▼◀▶** buttons to move to the area you want to enlarge.
4. Press the **ENTER** button.
normal size → 2X → 4X → 2X → normal size

Using Bookmarks

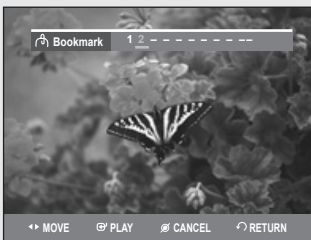

This feature lets you bookmark sections of a DVD or DVD-R/-RW (V mode), so you can quickly find them.

◆ Setting Bookmarks

1. Press the **MARKER** button during playback.
2. Press the **MARKER** button during playback. Press the **ENTER** button when the desired scene appears.
The number 1 is displayed and the scene is memorized.
3. Press the **◀▶** button to move to the next position.
4. Press the **ENTER** button when the desired scene appears.
The number 2 is displayed and the scene is memorized.
 - Repeat above to bookmark other positions.
 - You can bookmark up to 10 scenes.



- When the disc tray is opened and then closed, bookmarks will disappear.
- The Bookmark display may differ depending on the disc type.

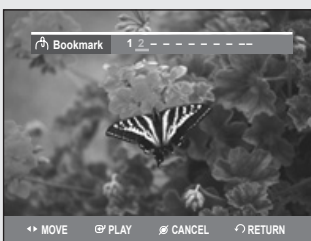

◆ Playing Back a Bookmark

1. Press the **MARKER** button during playback.
2. Press the **◀▶** buttons to select a bookmarked scene.
3. Press the **ENTER** or **PLAY**(**⏪**) button to start playing from the selected scene.

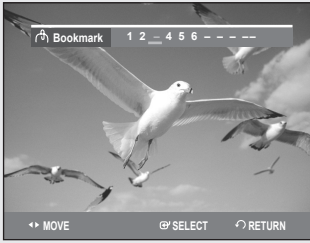

◆ Clearing a bookmark

1. Press the **MARKER** button during playback
2. Press the ◀ ▶ buttons to select a bookmarked scene.
3. Press the **CANCEL** button to delete the selected bookmark.

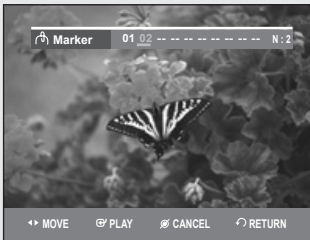

Using Markers

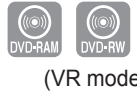

◆ Setting Markers

1. Press the **MARKER** button during playback.
2. Press the **ENTER** button when the desired scene appears.
The number 01 is displayed and the scene is memorized.
3. Press the ◀ ▶ button to move to the next position.
4. Press the **ENTER** button when the desired scene appears.
The number 02 is displayed and the scene is memorized.
 - DVD-RAM or DVD-RW (VR Mode) discs have the Marker function instead of the Bookmark function.
The Marker function allows you to mark up to 99 scenes. Since the scenes may be displayed as many different pages, numbering is necessary.
If a disc in use is encoded with Disc Protect, Markers cannot be set or deleted. Only playback is available.

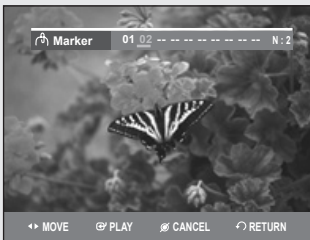

◆ Playing Back a Marker

1. Press the **MARKER** button during playback.
2. Press the ◀ ▶ buttons to select a bookmarked scene.
3. Press the **ENTER** or **PLAY** (▶) button to start playing from the selected scene.
 - If you press the **SKIP** (⊖) button, it moves to the beginning of the marker. Pressing the button once again within 3 seconds returns to the beginning of the previous marker.
 - If you press the **SKIP** (⊖) button, it moves to the next marker.



◆ Clearing a Marker



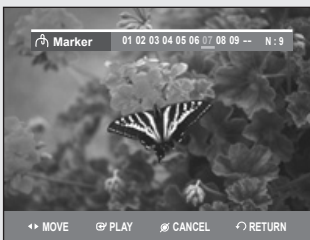



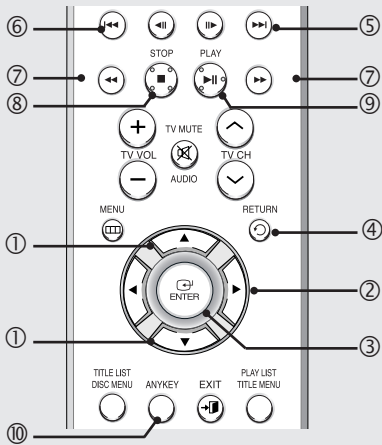

1. Press the **MARKER** button during playback.
2. Press the ◀ ▶ buttons to select a bookmarked scene.
Press the **CANCEL** button to delete the selected bookmark.
 - When a marker is cleared while a DVD-RAM/DVD-RW(VR mode) is playing, marker numbers will change. For example, if the 7th marker is cleared after ten markers are registered, the marker numbers after the eighth will automatically move ahead by one and the 8th marker becomes the 7th.



Playing an Audio CD/MP3

Buttons on the Remote Control Used for CD Playback



1. ▲ ▼ : Selects a track (song).
2. ► : Plays the selected track (song).
3. **ENTER**() button : Plays the selected track (song).
4. **RETURN**() button: Moves to the folder to which the current song belongs.
5. **SKIP**() button : Plays the next track.
6. **SKIP**() button : Returns to the beginning of the current track when pressed during playback. If pressed again, your DVD recorder moves to and plays the previous track. If you press this button within three seconds after playback starts, the previous track will be played. If you press this button after three seconds, the current track will be replayed from the beginning.
7. **SEARCH**() / () button : Fast Play (X2, X4, X8)
8. **STOP**() : Stops a track(song).
9. **PLAY/PAUSE**() : Plays a track(song) or pauses playback.
10. **ANYKEY** : To select the sub menu on screen display (Repeat or Play Option).

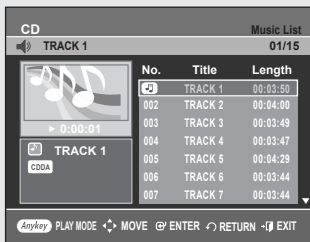

Playing an Audio CD(CD-DA)

1. Insert an audio CD (CD-DA) into the disc tray.
The audio CD menu appears and the tracks (songs) are played automatically.
2. Press the ▲ ▼ buttons to select the track you want to hear, and then press the **ENTER** button or ► button.

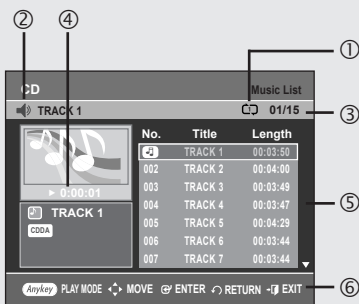

◆ Audio CD(CD-DA) Screen Elements

1. **PLAY MODE icon**
2. **Current track (song)** : Displays the number of the track currently being played.
3. Displays the current play index and total track number.
4. Shows the operating state of a disc and the current playback time.
5. Displays the track list (song list) and the playing time of each track.
6. Button display.

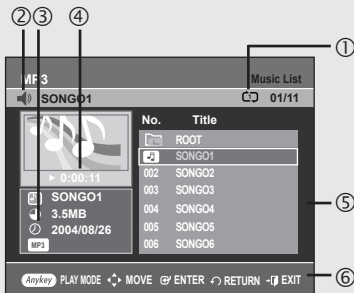
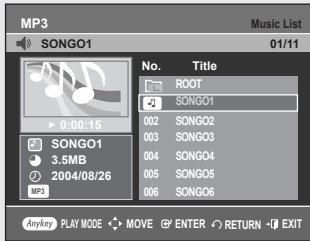

Playing an MP3 Disc

1. Insert an MP3 disc into the disc tray.
And press the ▲ ▼ buttons to select **Disc Navigation**, and then press the **ENTER** or ► button.
2. Press the ▲ ▼ buttons to select **Music**, and then press the **ENTER** or ► button.
The MP3 menu appears and the tracks(songs) are played automatically.
3. Press the ▲ ▼ buttons to select the track (song) you want to hear, and then press the **ENTER** button or ► button.

◆ MP3 Screen Elements

1. **PLAY MODE** icon
2. **Current track (song)** : Displays the name of the track being played.
3. MP3 file information.
4. Shows the operating state of a disc and the current playback time.
5. Displays the information for the folder and its tracks.
6. Button display.

Playing Repeatedly



1. Press the **ANYKEY** button during playback. The play mode window appears.
2. Select the desired repeat mode using the ◀ ▶ buttons, and then press the **ENTER** button.
 - **Track** : Selected track is played repeatedly.
 - **Disc** : Inserted disc is played repeatedly.
 - **Folder(mp3 only)** : Tracks in the current folder are played repeatedly.

To return to normal playback

3. Select **Off** in play mode window using the ◀ ▶ buttons, and then press the **ENTER** button.



Play Option Mode

1. During Stop, Press the **ANYKEY** button. The Play option will be highlighted.
 - During Playback, Repeat Mode will be highlighted.
2. Select a desired play option (Normal, Random, Intro or Playlist) using the ◀ ▶ buttons. Press the **ENTER** button.
 - **Normal** : Tracks on a disc are played in the order in which they were recorded on the disc.
 - **Random[R]** : The Random option plays the disc's tracks in random order. After a random list is generated and played completely, another random list is generated and played. Random Play is continued until the play option is changed.
 - **Intro[I]** : The first 10 seconds of each track will be played. If you want to listen to the music that you have selected, press the **ENTER** button or **PLAY** (⏮) button. The play option will be changed to Normal Play. When Intro Play is completed, Normal Play is performed.
 - **Playlist** : The Playlist playback option allows you to select the order in which you want tracks to play.

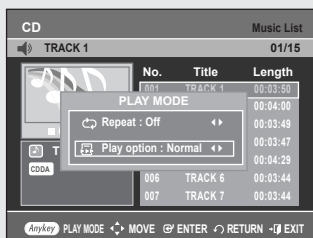

To Program Tracks

You can register a maximum of 30 tracks in the playlist.

1. Press the **ANYKEY** button during playback, then select **Play option** using ▲ ▼ buttons.
2. Select **Playlist** using the ◀ ▶ buttons, and then press the **ENTER** button.
The Playlist screen will appear.
Select tracks in the order in which you want them to play using the ▲ ▼ buttons.
Press the **ENTER** button.
If there is a track on your playlist you wish to remove. Press the ▶ button, then press the ▲ ▼ buttons to select the track you wish to remove, then press the **CANCEL** button. The selected track will be removed.
3. Press the **PLAY** (⏮) button to playback the playlist.

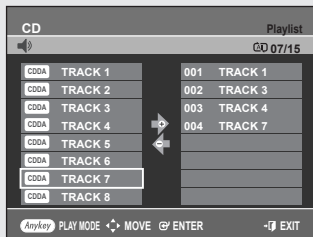

Playing a Picture CD

1. Insert an JPEG disc into the disc tray.
2. Press the ▲ ▼ buttons to select **Disc Navigation**, and then press the **ENTER** or ▶ button.
3. Press the ▲ ▼ buttons to select **Photo**, and then press the **ENTER** or ▶ button.
4. Press the ▲ ▼ ◀ ▶ buttons to select a picture.
 - To see the next 8 pictures, press the **SKIP** (⏭) button.
 - To see the previous 8 pictures, press the **SKIP** (⏮) button.

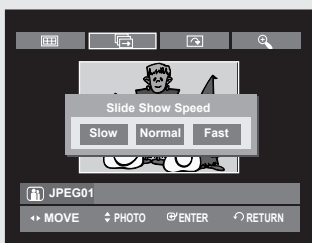

5-1. If you press the **PLAY** (▶) button, the Slide show screen will appear. The picture interval (Slide show speed) must be set.

5-2. Press the **ENTER** button with a picture selected in the Album screen and select a display mode (**Album screen** (🗃), **Slide show** (▶), **Rotation** (🔄) or **Zoom** (🔍)) using the ◀▶ buttons, then press the **ENTER** button.

🗃 : Returns to the Album screen.

▶ : The unit enters slide show mode.

Before the slide show can begin, the picture interval (Slide show speed) must be set.

🔄 : Each time the **ENTER** button is pressed, the picture rotates 90 degrees clockwise.

🔍 : Each time the **ENTER** button is pressed, the picture is enlarged up to 4X. (**Normal** → **2X** → **4X** → **2X** → **Normal**)

• Press the **ANYKEY** button to display or clear menus.

Playing the Title List

Follow these instructions to play back a scene from the Title List.

1. Press the **TITLE LIST** button. The Title List screen is displayed. Or use the **MENU** button.

- Press the **MENU** button.
- Press the ▲▼ buttons to select Title List, and then press the **ENTER** or ▶ button twice.

2. Press the ▲▼ buttons to select **Title**.

- Press the **PLAY** button. The selected entry (title) will be played back.
- Press the **ENTER** or ▶ button. The Edit menu is displayed on the right. (**Rename**, **Delete**, **Edit**, **Protection** : See pages 57~59)

3. To stop playing the title, press the **STOP** (⏹) button.

To return to the title list screen, press the **TITLE LIST** button.

Title List Screen Elements

① Playback screen for recorded entries

② Information window for the selected entry : Title name, recording date, lock status, record mode

③ Recorded entry No.

④ Recorded entry title

⑤ Recording length (i.e., the playing time)

⑥ Title list edit items

Play : Plays the selected entry.

Rename : Renames the title of a selected entry.

Delete : Deletes the selected entry from the list.

Edit : Deletes a section.

Protection : Locks or unlocks the selected entry.

⑦ Button display

■ By pressing the **ANYKEY** button, you can play the desired title.

■ This may depend on the the disc type.

■ DVD-R/DVD-RW(Video) discs have limited editing function. (See page 36)

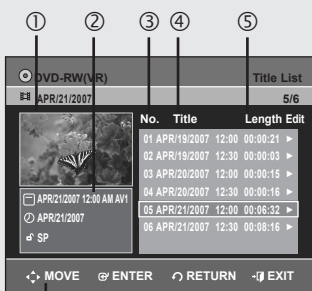



This section introduces basic functions of DVD editing.

• **Title List**

A title is a section of recorded video and audio.

The Title List shows a list to help you select a title.

If one title is deleted from the title list, that title cannot be played again.

• **Playlist**

This refers to a unit of playback, which is made by selecting a desired scene in the entire Title List.

When one playlist is played, only the scene selected by the user will play and then stop. Even if a playlist is deleted, the original recorded title will not be deleted.

Recording or editing might not be completed if a problem such as a sudden power failure occurs.

Please be aware that material that has been damaged cannot be retrieved.

Basic Editing (Title List)

Renaming (Labeling) a Title



Follow these instructions to rename a title list entry, i.e., to edit the title of a recorded program.

1. Press the **TITLE LIST** button. The Title List screen is displayed.
Or use the **MENU** button.
 - Press the **MENU** button.
 - Press the **▲ ▼** buttons to select Title List, and then press the **ENTER** or **▶** button twice.
2. Press the **▲ ▼** buttons to select an entry you want to rename from the **Title List**, and then press the **ENTER** or **▶** button.
3. Press the **▲ ▼** buttons to select **Rename**, and then press the **ENTER** or **▶** button.
The Rename screen is displayed.
4. Select the desired characters using the **▲ ▼ ◀ ▶** buttons, press the **ENTER** button.
 - **Back Space** : Deletes the character before the cursor.
 - **Space** : Enters a blank and moves the cursor one forward (to the right).
 - **Delete** : Deletes the character at the cursor position.
 - **Clear** : Deletes all the character inputs.
 - **Save** : Registers the character inputs.
 - The maximum number of characters that can be entered is 31. All 31 characters can be displayed by pressing the **INFO** button twice.
5. Press the **▲ ▼ ◀ ▶** buttons to select **Save**, and then press the **ENTER** button.
The changed title name is displayed on the title item of the selected Title list entry.

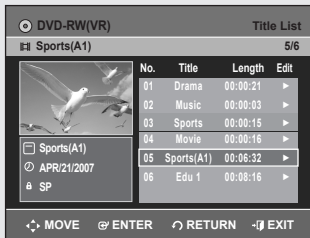
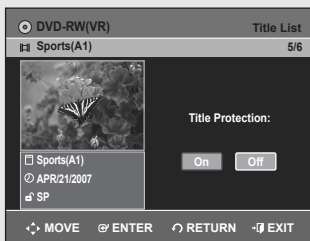

Locking (Protecting) a Title



Follow these instructions to lock an entry to protect it from accidental deletion.

1. Press the **TITLE LIST** button. The Title List screen is displayed.
Or use the **MENU** button.
 - Press the **MENU** button.
 - Press the **▲▼** buttons to select Title List, and then press the **ENTER** or **▶** button twice.
2. Press the **▲▼** buttons to select an entry you want to protect from the **Title List**, and then press the **ENTER** or **▶** button.
3. Press the **▲▼** buttons to select **Protection**, and then press the **ENTER** or **▶** button.
4. Press the **◀▶** buttons to select **On**, and then press the **ENTER** button. The lock icon on the information window for the selected entry changes to the locked status. (🔒 → 🔒)
If you want to unlock the title entry, select the protected title and set the Protection function to **Off**.

Deleting a Title



Follow these instructions to delete an entry from the Title List.

1. Press the **TITLE LIST** button. The Title List screen is displayed.
Or use the **MENU** button.
 - Press the **MENU** button.
 - Press the **▲▼** buttons to select Title List, and then press the **ENTER** or **▶** button twice.
2. Press the **▲▼** buttons to select an entry you want to delete from the Title List, and then press the **ENTER** or **▶** button.
3. Press the **▲▼** buttons to select **Delete**, and then press the **ENTER** or **▶** button.
You will be prompted with the confirmation message.
DVD-RAM, DVD-RW(VR mode): Since there is a Playlist present, the message "Do you want to delete?(Related playlists may be deleted.)" is displayed.
DVD-RW(Video mode), DVD-R: Since there is a Playlist not present, the message "Do you want to delete?" is displayed.
 - The message may be different depending on the type of disc.
4. Press the **◀▶** buttons to select **Yes**, and then press the **ENTER** button.



- You cannot delete a protected entry. If you want to delete a protected entry, select "Off" in the Title Protection menu.
- Once an entry is deleted from the Title List, it cannot be recovered.
- Once a DVD-R or DVD-RW is finalized, it cannot be deleted.
- With DVD-R discs, titles are only deleted from the menu, however, the Title remains physically on the disc.

Deleting a Section of a Title

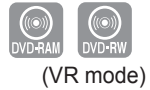

Follow these instructions to delete a section of a Title List entry.

1. Press the **TITLE LIST** button. The Title List screen is displayed.
Or use the **MENU** button.
 - Press the **MENU** button.
 - Press the **▲▼** buttons to select Title List, and then press the **ENTER** or **▶** button twice.
2. Press the **▲▼** buttons to select an entry you want to edit from the Title List, and then press the **ENTER** or **▶** button.
3. Press the **▲▼** buttons to select **Edit**, and then press the **ENTER** or **▶** button.
4. Press the **ENTER** button at the starting point.
The image and starting point time are displayed on the section deletion starting point window.
5. Press the **ENTER** button at the end point.
The image and end point time are displayed in the Section deletion ending point window.
6. Press the **◀▶** buttons to select **Delete**, and then press the **ENTER** button.
The message "Do you want to delete?(Deleted part will not be restored)" is displayed.
7. Press **◀▶** buttons to select **Yes**, and then press the **ENTER** button.
The selected section is deleted.
To return to the Title List screen, press the **◀▶** buttons to select **Return**.

◆ Edit Title List Screen Elements

- 1 Playback bar
- 2 Title List No.
- 3 Section deletion starting point window and time
- 4 Section deletion end point window and time
 - Select the start and end points of the section you want to delete using the playback related buttons.
 - Playback related buttons (**◀** , **▶** , **⏪** , **⏩** , **⏮** , **⏭**).

- The length of the section to be deleted must be at least 5 seconds long.
- If the length of the section to be deleted is less than 5 seconds, you will be prompted with the message "The range is too short."
- If the end time precedes the starting point, you will be prompted with the message "End point cannot be marked earlier than start point".
- The section cannot be deleted when it includes a still picture.

Advanced Editing (Playlist)

Creating a Playlist



(VR mode)

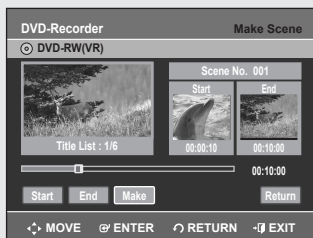

Follow these instructions to create a new playlist entry from a recorded title.

1. With the unit in Stop mode, press the **MENU** button on the remote control.
2. Press the **▲▼** buttons to select **Playlist**, and then press the **ENTER** or **▶** button.
3. Press the **▲▼** buttons to select **New Playlist**, and then press the **ENTER** or **▶** button.
The Make Scene screen is displayed.
4. Press the **ENTER** button at the start point.
 - The image and starting point time are displayed on the Start window.
 - The yellow-colored selection bar moves to the **End** item.
 - Select the starting point of the section from which you want to create a new scene using the playback related buttons (**◀**, **⏪**, **⏩**, **▶**, **⏹**, **⏸**, **⏮**, **⏭**).
5. Press the **ENTER** button at the end point.
 - The image and end point time are displayed on the **End** window.
 - The yellow-colored selection bar moves to the **Make** button.

- To make a new playlist -

6. Press the **◀▶** buttons to select **Make**, and then press the **ENTER** button.
A new Scene will be added to the current Playlist.
A new Make Scene screen is displayed.
Repeat the above steps 4~6 to create further scenes.



- If you want to make a new playlist, go to **MENU** → new playlist.
- You can check and see all the scenes on the Edit Playlist screen.

- To return to the Edit Playlist menu -

7. Press the **◀▶** buttons to select **Return**, and then press the **ENTER** button.
The Edit Playlist screen is displayed.



- You can create up to 99 playlist entries.
- Depending on the disc type, the displayed screen may look slightly different.

Playing Entries in the Playlist



(VR mode)

Follow these instructions to play the playlist entries.

1. With the unit in stop mode, press the **PLAYLIST** button.
The Edit Playlist screen is displayed.
2. Press the **▲▼** buttons to select the title you want to edit from the Playlist, and then press the **ENTER** or **▶** button.
3. Press the **▲▼** buttons to select **Play**, and then select the **ENTER** button.
The playlist entries will be played.
4. Press the **STOP** (**⏹**) button to stop playing.
The screen returns to the Edit Playlist screen.

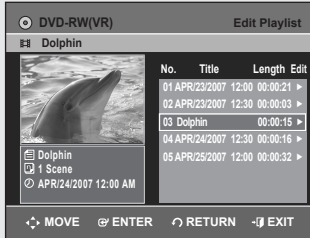
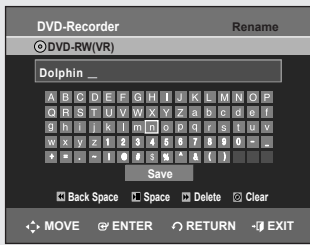

Renaming a Playlist Entry



(VR mode)

Follow these instructions to rename a playlist entry, i.e. to edit the title of a playlist entry.

1. With the unit in stop mode, press the **PLAY LIST** button.
The Edit Playlist screen is displayed.
2. Press the **▲▼** buttons to select the title you want to edit from the Playlist, and then press the **ENTER** or **▶** button.
3. Press the **▲▼** buttons to select **Rename**, and then press the **ENTER** button.
4. Enter the desired characters using the **▲▼◀▶** buttons.
 - **Back Space**: Deletes the character before the cursor.
 - **Space**: Enters a blank and moves the cursor one forward (to the right).
 - **Delete**: Deletes the character at the cursor position.
 - **Clear**: Deletes all the character inputs.
 - **Save**: Registers the character inputs.
 - The maximum number of characters that can be entered is 31. All 31 characters can be displayed by pressing the **INFO** button twice.
5. Press the **▲▼◀▶** buttons to select **Save**, and then press the **ENTER** button.
The changed title name is displayed on the title item of the selected playlist entry.

Editing a Scene for the Playlist

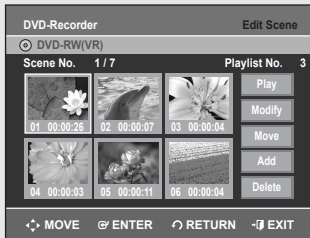

(VR mode)

Follow these instructions to edit scenes for a playlist

1. With the unit in stop mode, press the **PLAY LIST** button.
The Edit Playlist screen is displayed.
2. Press the **▲▼** buttons to select the title you want to edit from the Playlist, and then press the **ENTER** or **▶** button.
3. Press the **▲▼** buttons to select **Edit Scene**, and then press the **ENTER** button.
The Edit Scene screen is displayed.

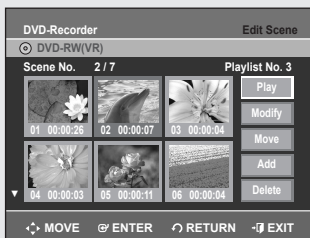

Playing a Selected Scene

4. Press the **▲▼◀▶** buttons to select the scene you want to play, and then press the **ENTER** button.
The playlist entry to be played is selected.
5. Press the **ENTER** button.
The selected scene is played.
 - To stop playback of a selected scene, press the **STOP(⊙)** button.

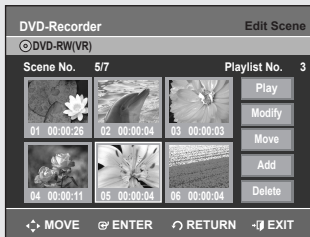
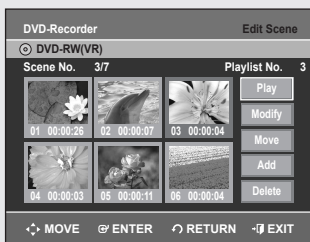
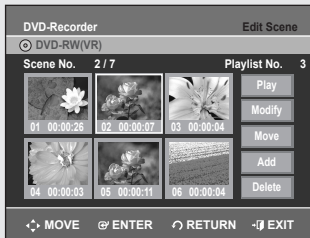
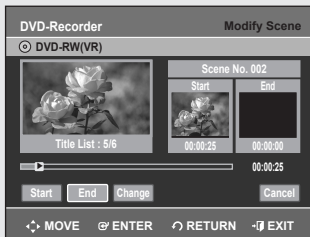
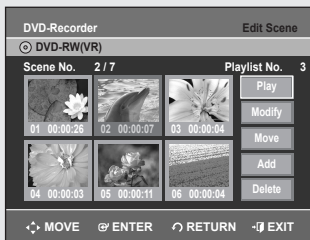

Modifying a Scene (Replacing a Scene)

Follow steps 1 to 3 of *Editing a Scene for the Playlist* on page 61.

- Press the ▲▼◀▶ buttons to select the scene you want to modify, and then press the **ENTER** button.
- Press the ▲▼ buttons to select **Modify**, and then press the **ENTER** button.
 - The image and starting point time are displayed on the Start window.
 - Select the starting or ending point of the section you want to modify using the playback related buttons (⏪, ⏩, ⏴, ⏵, ⏶, ⏷, ⏸, ⏹).
- Press the **ENTER** button at the end point of the scene.
 - The image and ending point time are displayed on the End window.
- Press the ◀▶ buttons to select **Change**, and then press the **ENTER** button.
 - The scene you want to modify is changed with the selected section.

Moving a Scene (Changing the Position of a Scene)

Follow steps 1 to 3 of *Editing a Scene for the Playlist* on page 61.

- Press the ▲▼◀▶ buttons to select the scene you want to move (change the position), and then press the **ENTER** button.
- Press the ▲▼ buttons to select **Move**, then press the **ENTER** button.
 - A yellow selection window is displayed on the scene to be moved.
- Press the ▲▼◀▶ buttons to select the position to which you want to move the selected scene, and then select the **ENTER** button.
 - The selected scene is moved to the selected position.



- Depending on the disc type, the displayed screen may look different.

Adding a Scene

Follow steps 1 to 3 of *Editing a Scene for the Playlist on page 61*.

- Press the **▲▼◀▶** buttons to select the scene that will have a new scene inserted before it, and then press the **ENTER** button.
A yellow selection window is displayed on the scene to be added as the new scene.
- Press the **▲▼** buttons to select **Add**, then press the **ENTER** button.
- Press the **ENTER** button at the starting point of the scene.
 - The image and starting point time are displayed on the **Start** window.
 - Select the end point of the section where you want to add the new scene using the playback related buttons (**▶**, **⏪**, **⏩**, **⏴**, **⏵**, **⏮**, **⏭**).
- Press the **ENTER** button at the end point of the scene.
 - The image and end point time are displayed in the **End** window.
 - To cancel, press the **◀▶** buttons to select **Cancel** and then press the **ENTER** button.
- Press the **◀▶** buttons to select **Add**, and then press the **ENTER** button.
 - The section you want to add is inserted prior to the scene selected in step 4.

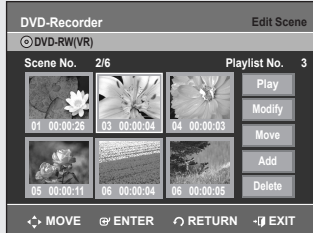
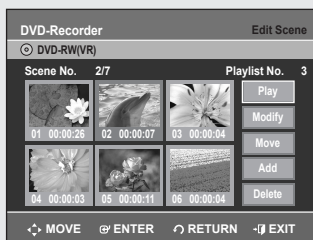
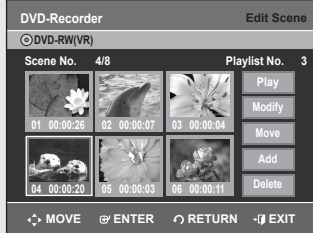
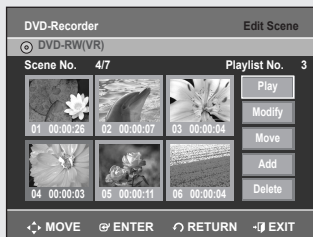

Deleting a Scene

Follow steps 1 to 3 of *Editing a Scene for the Playlist on page 61*.

- Press the **▲▼◀▶** buttons to select the scene you want to delete, and then press the **ENTER** button.
- Press the **▲▼** buttons to select **Delete**, and then press the **ENTER** button.

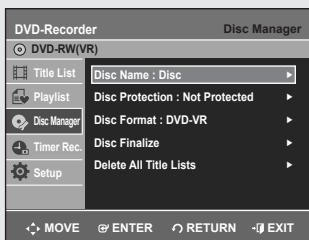
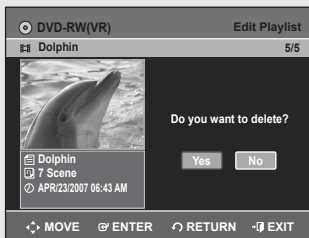
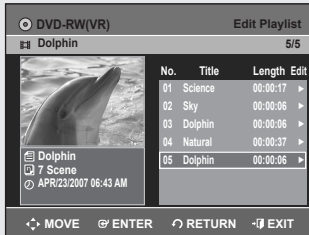
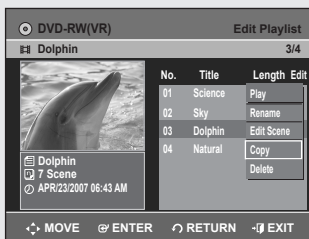

Copying a Playlist Entry to the Playlist

1. Press the **PLAY LIST** button.
The Edit Playlist screen is displayed.
2. Press the **▲ ▼** buttons to select the title you want to copy to the Playlist, and then press the **ENTER** or **▶** button.
3. Press the **▲ ▼** buttons to select **Copy**, and then press the **ENTER** button.
Playlist that has been selected will be copied.

■ The playlist can contain up to 99 playlist entries (titles).

Deleting a Playlist Entry from the Playlist

1. With the unit in Stop mode, press the **PLAY LIST** button.
The Edit Playlist screen is displayed.
2. Press the **▲ ▼** buttons to select the title you want to edit from the Playlist, and then press the **ENTER** or **▶** button.
3. Press the **▲ ▼** buttons to select **Delete**, and then press the **ENTER** button.
4. Press the **◀ ▶** buttons to select **Yes**, and then press the **ENTER** button.
After the delete operation is complete, it will automatically return to the Edit Playlist screen.

Disc Manager

Editing the Disc Name



Follow these instructions to give a name to a disc.

1. With the unit in Stop mode, press the **MENU** button on the remote control.
2. Press the **▲ ▼** buttons to select **Disc Manager**, then press the **ENTER** or **▶** button.
3. Press the **▲ ▼** buttons to select **Disc Name**, then press the **ENTER** or **▶** button.
The Rename screen is displayed.
4. Enter the desired characters using the **▲ ▼◀ ▶** buttons.
 - **Back Space** : Deletes the character before the cursor.
 - **Space** : Enters a blank and moves the cursor one forward (to the right).
 - **Delete** : Deletes the character at the cursor position.
 - **Clear** : Deletes all the character inputs.
 - **Save** : Registers the character inputs.
 - The maximum number of characters that can be entered is 31. All 31 characters can be displayed by pressing the **INFO** button twice.
5. Press the **▲ ▼◀ ▶** buttons to select **Save**, and then press the **ENTER** button.
A disc name is given to the disc.

■ You may need to disable disc protection before beginning editing. (see page 65.)

■ Depending on the kind of disc, the displayed screen may be different.

Disc Protection



Disc Protection allows you to protect your discs from being formatted or deleted due to unintended operations

1. With the unit in Stop mode, press the **MENU** button on the remote control.
2. Press the **▲▼** buttons to select **Disc Manager**, and then press the **ENTER** or **▶** button.
3. Press the **▲▼** buttons to select **Disc Protection**, then press the **ENTER** or **▶** button.
4. Press the **▲▼** buttons to select **Protected**, then press the **ENTER** button.

Formatting a Disc



Use these instructions to format a disc. Disable disc protection before formatting.

1. With the unit in Stop mode, press the **MENU** button on the remote control.
2. Press the **▲▼** buttons to select **Disc Manager**, and then press the **ENTER** or **▶** button.
3. Press the **▲▼** buttons to select **Disc Format**, and then press the **ENTER** or **▶** button.

DVD-RAM

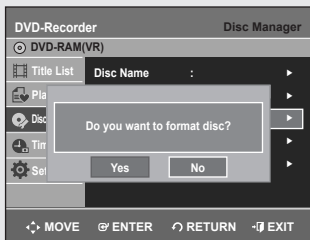

DVD-RAM

- You will be prompted with the confirmation message “Do you want to format disc?”.
- If you select **Yes** using the **◀▶** buttons and press the **ENTER** button, you will be prompted with the confirmation message “All data will be deleted. Do you want to continue?”.

DVD-RW

- You will be prompted with the confirmation message “Choose the recording format for DVD-RW”
4. Press the **◀▶** buttons to select desired mode, then press the **ENTER** button.
 - You will be prompted again with the message “All data will be deleted. Do you want to continue?”
 5. Press the **◀▶** buttons to select **Yes**, and then press the **ENTER** button.
The disc is formatted.

DVD-RW



DVD-VR and DVD-V modes are compatible with the following disc types.

| | | |
|------|---------|--------|
| DISC | DVD-VR | DVD-V |
| | DVD-RAM | DVD-RW |
| | DVD-RW | DVD-R |



- Menu items may differ depending on the disc type.

Finalizing a Disc



After you record titles onto a DVD-RW/DVD-R disc with your DVD recorder, it needs to be finalized before it can be played back on external devices.

1. With the unit in Stop mode, press the **MENU** button on the remote control.
2. Press the **▲▼** buttons to select **Disc Manager**, and then press the **ENTER** or **▶** button.
3. Press the **▲▼** buttons to select **Disc Finalize**, and then press the **ENTER** or **▶** button.
4. Press the **◀▶** buttons to select **Yes**, then press the **ENTER** button. You will be prompted again with the message "Disc will be finalized. Do you want to continue?".
5. Press the **◀▶** buttons to select **Yes**, and then press the **ENTER** button. The disc is finalized.



- Once a disc is finalized, you cannot delete entries from the record list.
- Once a DVD-R/DVD-RW(video mode) disc is finalized, it is playable in a standard DVD player.
- Depending on disc type, the displayed screen may appear slightly different.
- Finalizing time may be different depending on the amount of data recorded on the disc.
- Data on the disc will be damaged if the recorder is powered off during finalizing process.
- You can finalize automatically using EZ REC MODE. (See page 44)

Unfinalizing a Disc (V/VR mode)



1. With the unit in Stop mode, press the **MENU** button on the remote control.
2. Press the **▲▼** buttons to select **Disc Manager**, and then press the **ENTER** or **▶** button.
3. Press the **▲▼** button to select **Disc Unfinalize**, and then press the **ENTER** or **▶** button. You will be prompted with the message "Do you want to unfinalize disc?".
4. Press the **◀▶** buttons to select **Yes**, then press the **ENTER** button. You will be prompted again with the message "Disc will be unfinalized. Do you want to continue?".
5. Press the **◀▶** buttons to select **Yes**, and then press the **ENTER** button. The disc is unfinalized.



- A DVD-RW can be finalized or unfinalized in Video mode.

| | Finalize | Unfinalize |
|-----------|-------------------|---|
| Mark | DVD-Video(RW) | DVD-RW(V) |
| Operation | Same as DVD-Video | Additional recording, protection and deletion are possible. |

- A DVD-RW can be finalized or unfinalized in VR mode.

| | Finalize | Unfinalize |
|-----------|---|---|
| Mark | DVD-RW(VR:F) | DVD-RW(VR) |
| Operation | Additional recording, deletion, editing, and protection are impossible. | Additional recording, deletion, editing, and protection are possible. |



Delete All Title Lists



The disc protection should be disabled first.

1. With the unit in Stop mode, press the **MENU** button on the remote control.
2. Press the **▲ ▼** buttons to select **Disc Manager**, and then press the **ENTER** or **▶** button.
3. Press the **▲ ▼** buttons to select **Delete All Title Lists**, and then press the **ENTER** or **▶** button.
 - When Protected Entry exists: The Delete All Title List function will not operate. If you want to delete a protected title, disable Protection for it on the Lock item. (See page 58)
4. Press the **◀ ▶** buttons to select **Yes**, and then press the **ENTER** button.
All title lists are deleted.



Additional Information

Troubleshooting

If your product malfunctions, go through the checkpoints below before contacting a Samsung authorized service center.

Power

The input is displayed for a while when the power is turned on.

- Checkpoint 1** The DVD recorder requires some time to initialize and the input will be displayed for approx. 10 seconds after it is turned on.

Recording

Cannot record TV programs.

- Checkpoint 1** Check whether the power cord is securely plugged into the power outlet.
- Checkpoint 2** Check the free space on your DVD-RAM/DVD-RW/DVD-R discs.

I pressed the REC button but there is no response.

- Checkpoint 1** Recording is possible for DVD-RAM/DVD-RW/DVD-R discs only. If a program is copy protected, it cannot be recorded.

Playback

Cannot play the disc.

- Checkpoint 1** Check whether the disc is inserted correctly with the label facing up.
- Checkpoint 2** Check the regional code of the DVD disc.
- Checkpoint 3** This DVD recorder cannot play some types of discs. (See pages 5, 46.)

⊗ icon appears on the screen.

- Checkpoint 1** You cannot use this operation or function due to one of the following reasons:
 - (1) Your DVD disc restricts it.
 - (2) Your DVD disc does not support this feature (for example: angles)
 - (3) The feature is not available at the moment.
 - (4) You've requested a title, chapter, or scan time that is out of range.

Play mode settings are different from the settings configured in the Settings menu.

- Checkpoint 1** The disc does not support all selected functions. In this case, some settings configured in the settings menu may not work properly.

Cannot change the aspect ratio.

- Checkpoint 1** The aspect ratio is fixed for DVD discs. (See page 31.)

The angle operation does not work while playing a DVD disc.

- Checkpoint 1** The angle operation is available only when the disc contains images captured from different angles.

The selected audio and/or subtitle language is not played.

- Checkpoint 1** Audio and subtitle languages are disc specific. Only the sound and subtitle languages contained on the DVD disc are available and displayed in the disc menu.

Video

The disc revolves, but no image or bad quality images are displayed.

- Checkpoint 1** Check whether there is damage to or any foreign material on your disc.
- Checkpoint 2** Some low quality discs may not play properly.
- Checkpoint 3** If scenes change from dark to bright suddenly, the screen may shake vertically temporarily. This does not mean that the unit is defective.

Sound

No sound.

- Checkpoint 1** Are you watching a program in scan mode?
If you are playing a program at a speed other than normal and fast1 speed, the sound will not be heard.
- Checkpoint 2** Check the connections and settings.
- Checkpoint 3** Check whether the disc is damaged.
Clean the disc, if necessary.
- Checkpoint 4** Check whether the disc is inserted correctly with the label facing up.

No audio output.

- Checkpoint 1** Check whether you have selected the correct digital output options in the Audio Output Options menu.
(See page 30.)

Timer Recording

Timer lamp flickers.

- Checkpoint 1** Check if there is enough space in the disc for recording.
- Checkpoint 2** Check whether the current disc is recordable or not.
Make sure to check before the start time of recording.

Timer recording does not work properly.

- Checkpoint 1** Re-check the recording time and the end time settings again.
- Checkpoint 2** Recording will be cancelled, if the power is disconnected due to a power failure or other similar reason, while recording.

HDMI

No HDMI output.

- Checkpoint 1** Check to see that the Video output is HDMI enabled.
- Checkpoint 2** Check the connection between the TV and the HDMI jack of the DVD Recorder.
- Checkpoint 3** See if your TV supports this 480p/720p/1080i DVD Recorder.

Abnormal HDMI output screen.

- Checkpoint 1** If snow noise appears on the screen, it means that the TV does not support HDCP (High-bandwidth Digital Content Protection).

HDMI output Jitter

- Checkpoint 1** Check if your TV system is setup correctly.
- Checkpoint 2** Screen Jitter may occur when the frame rate is converted from 50Hz to 60Hz for 720p/1080i HDMI (High Definition Multimedia Interface) Output.
- Checkpoint 3** Please refer to the user's manual of your TV.

Remote Control Unit

The remote control doesn't work.

- Checkpoint 1** Point the remote control at the remote control sensor on your DVD recorder.
Allow for proper distance. Remove obstacles between your DVD recorder and the remote control.
- Checkpoint 2** Check whether the batteries are empty.

Other

I forgot my password for parental supervision.

- Checkpoint 1** Remove the disc. Press the **INPUT SEL.** and **REC MODE** buttons on the front panel of the DVD Recorder simultaneously for 5 seconds or more when the power is on. All settings including the password will revert to the factory settings. Do not use this unless absolutely necessary.
(Note that this function is possible only when no disc is inserted.)

Is it possible to change a subtitle and an audio signal on a recorded disc?

- Checkpoint 1** A recorded disc is played with only the subtitle and the audio signal which were selected during recording.

Other problems.

- Checkpoint 1** Read the table of contents and then find and read the section describing your problem, and follow the instructions given.
- Checkpoint 2** Turn your DVD recorder off and on.
- Checkpoint 3** If the problem still persists, contact a nearby Samsung service center.

Error Message Solutions

Before contacting a Samsung authorized service center, perform the following simple checks.

| Error Message | Solution / Explanation |
|---|---|
| You cannot record a copy protected movie. | ◆ You can't record the video since it is protected by copyright. |
| You cannot record. This disc is protected. | ◆ The disc you are using is protected. To record on this disc or use this function, disable the disc protection function. Refer to page 65. |
| This disc cannot be formatted (the disc is protected). | |
| This disc cannot be renamed (the disc is protected). | |
| The disc cannot be finalized (the disc is protected). | |
| This [Menu] is not available (the disc is protected). | |
| The disc cannot be played, Please check the regional code of the disc. | ◆ The disc does not match the regional code for your area and cannot be played on this device. |
| This disc cannot be formatted. Please check the disc. | ◆ Make sure there are no scratches or dirt on the disc. |
| You could not format the disc because of error detection. | |
| You could not finalize the disc because of error detection. | |
| You could not unfinalize the disc because of error detection. | |
| The disc cannot be played, Please check the TV system. | ◆ PAL format discs cannot be played on this unit. |
| The disc can be neither played nor recorded. | ◆ Make sure there are no scratches or dirt on the disc. |
| The disc cannot be played, Please check the disc. | |
| If the disc has invalid information, no more titles can be recorded. Please format the disc beforehand. | ◆ You can't use the disc because it contains errors from previous recordings. Use the disc after formatting. |

Error Message Solutions

| Error Message | Solution / Explanation |
|--|---|
| Error is detected on the disc. | <ul style="list-style-type: none"> ◆ You can't use the disc because it contains errors from previous recordings. Use the disc after formatting. |
| System error is found. Please try it again after turning off the power. | <ul style="list-style-type: none"> ◆ When operating, errors happen. Turn off the device. (To turn off, press and hold the power button on the front of the device for 10 seconds.) After turning off, press the Open button and remove the disc from the device. |
| The DV device is not connected. | <ul style="list-style-type: none"> ◆ Make sure the DV device is connected properly to the DV connection Jack. If it is connected properly, turn it off and on once again. |

If you are unable to solve the problem after reading the above instructions, note:

- ◆ The model and serial number on the rear of your DVD Recorder
- ◆ The warranty information
- ◆ A clear description of the problem

Then contact your nearest SAMSUNG authorized service center. Call 1-800-SAMSUNG for a center near you.

Specifications

| | | |
|---------------------------------|----------------------------|--|
| General | Power requirements | 120V AC, 60Hz |
| | Power consumption | 19 Watts |
| | Weight | 5.1 lb |
| | Dimensions | 16.9 in(W) x 8.5 in(D) x 1.9 in(H) |
| | Operating temp. | +41°F to +95°F |
| | Other conditions | Keep level when operating. Less than 75% operating humidity |
| Input | Video (1,2) | 1.0 V p-p at 75Ω load, sync negative |
| | | S-Video input (Y: 1.0Vp-p, C: 0.286Vp-p at 75Ω load) |
| | Audio(1,2) | Max.Audio Input Level : 2Vrms |
| | DV Input | IEEE 1394(4p) compatible jack |
| Output | Audio | Analog output jacks 1, 2 |
| | | Optical/Coaxial digital audio output |
| | | Full scale Analog output level : 2Vrms |
| | Video | Video output jack |
| | | S-Video output (Y : 1.0Vp-p, C:0.286Vp-p at 75Ω load) |
| | | Component output (Y : 1.0Vp-p, Pb: 0.70Vp-p, Pr: 0.70Vp-p at 75Ω load) |
| HDMI output (480p, 720p, 1080i) | | |
| Recording | Picture Compression format | MPEG-II |
| | Audio Compression format | Dolby Digital 2ch/256kbps |
| | Recording Quality | XP (about 8 Mbps), SP (about 4 Mbps), LP (about 2 Mbps), EP (about 1.2 Mbps or about 0.8 Mbps) |
| | Audio Frequency Response | 20 Hz ~ 20 kHz |

For DVD discs, audio signals recorded at 96kHz sampling frequency are converted and output at 48kHz.

Audio Output

| Disc Type | DVD | AUDIO CD(CDDA) |
|----------------------|------------|----------------|
| Analog Audio Output | 48 / 96kHz | 44.1kHz |
| Digital Audio Output | 48kHz | 44.1kHz |

Warranty

LIMITED WARRANTY TO ORIGINAL PURCHASER

This SAMSUNG brand product, as supplied and distributed by Samsung Electronics America, Inc. (SAMSUNG) and delivered new, in the original carton to the original consumer purchaser, is warranted by SAMSUNG against manufacturing defects in materials and workmanship for a limited warranty period of:

One (1) Year Parts / Ninety (90) days Labor (90 days Parts and Labor for Commercial Use)

This limited warranty begins on the original date of purchase, and is valid only on products purchased and used in the United States. To receive warranty service, the purchaser must contact SAMSUNG for problem determination and service procedures. Warranty service can only be performed by a SAMSUNG authorized service center. The original dated bill of sale must be presented upon request as proof of purchase to SAMSUNG or SAMSUNG's authorized service center. Transportation of the product to and from the service center is the responsibility of the purchaser.

SAMSUNG will repair or replace this product, at our option and at no charge as stipulated herein, with new or reconditioned parts or products if found to be defective during the limited warranty period specified above. All replaced parts and products become the property of SAMSUNG and must be returned to SAMSUNG. Replacement parts and products assume the remaining original warranty, or ninety (90) days, whichever is longer.

SAMSUNG's obligations with respect to software products distributed by SAMSUNG under the SAMSUNG brand name are set forth in the applicable end user license agreement. Non-SAMSUNG hardware and software products, if provided, are on an "AS IS" basis. Non-SAMSUNG manufacturers, suppliers, publishers, and service providers may provide their own warranties.

This limited warranty covers manufacturing defects in materials and workmanship encountered in normal, and except to the extent otherwise expressly provided for in this statement, noncommercial use of this product, and shall not apply to the following, including, but not limited to: damage which occurs in shipment; delivery and installation; applications and uses for which this product was not intended; altered product or serial numbers; cosmetic damage or exterior finish; accidents, abuse, neglect, fire, water, lightning or other acts of nature; use of products, equipment, systems, utilities, services, parts, supplies, accessories, applications, installations, repairs, external wiring or connectors not supplied and authorized by SAMSUNG, or which damage this product or result in service problems; incorrect electrical line voltage, fluctuations and surges; customer adjustments and failure to follow operating instructions, cleaning, maintenance and environmental instructions that are covered and prescribed in the instruction book; product removal or reinstallation; reception problems and distortion related to noise, echo, interference or other signal transmission and delivery problems. SAMSUNG does not warrant uninterrupted or error-free operation of the product.

THERE ARE NO EXPRESS WARRANTIES OTHER THAN THOSE LISTED AND DESCRIBED ABOVE, AND NO WARRANTIES WHETHER EXPRESS OR IMPLIED, INCLUDING, BUT NOT LIMITED TO, ANY IMPLIED WARRANTIES OF MERCHANTABILITY OR FITNESS FOR A PARTICULAR PURPOSE, SHALL APPLY AFTER THE EXPRESS WARRANTY PERIODS STATED ABOVE, AND NO OTHER EXPRESS WARRANTY OR GUARANTY GIVEN BY ANY PERSON, FIRM OR CORPORATION WITH RESPECT TO THIS PRODUCT SHALL BE BINDING ON SAMSUNG. SAMSUNG SHALL NOT BE LIABLE FOR LOSS OF REVENUE OR PROFITS, FAILURE TO REALIZE SAVINGS OR OTHER BENEFITS, OR ANY OTHER SPECIAL, INCIDENTAL OR CONSEQUENTIAL DAMAGES CAUSED BY THE USE, MISUSE OR INABILITY TO USE THIS PRODUCT, REGARDLESS OF THE LEGAL THEORY ON WHICH THE CLAIM IS BASED, AND EVEN IF SAMSUNG HAS BEEN ADVISED OF THE POSSIBILITY OF SUCH DAMAGES. NOR SHALL RECOVERY OF ANY KIND AGAINST SAMSUNG BE GREATER IN AMOUNT THAN THE PURCHASE PRICE OF THE PRODUCT SOLD BY SAMSUNG AND CAUSING THE ALLEGED DAMAGE. WITHOUT LIMITING THE FOREGOING, PURCHASER ASSUMES ALL RISK AND LIABILITY FOR LOSS, DAMAGE OR INJURY TO PURCHASER AND PURCHASER'S PROPERTY AND TO OTHERS AND THEIR PROPERTY ARISING OUT OF THE USE, MISUSE OR INABILITY TO USE THIS PRODUCT SOLD BY SAMSUNG NOT CAUSED DIRECTLY BY THE NEGLIGENCE OF SAMSUNG. THIS LIMITED WARRANTY SHALL NOT EXTEND TO ANYONE OTHER THAN THE ORIGINAL PURCHASER OF THIS PRODUCT, IS NONTRANSFERABLE AND STATES YOUR EXCLUSIVE REMEDY.

Some states do not allow limitations on how long an implied warranty lasts, or the exclusion or limitation of incidental or consequential damages, so the above limitations or exclusions may not apply to you. This warranty gives you specific legal rights, and you may also have other rights which vary from state to state.

To obtain warranty hardware service, please contact SAMSUNG at:

Samsung Electronics America, Inc.
105 Challenger Road Ridgefield Park, NJ 07660-0511
1-800-SAMSUNG (726-7864) and www.samsung.com

Contact SAMSUNG WORLD WIDE

If you have any questions or comments relating to Samsung products, please contact the SAMSUNG customer care center.

| Region | Country | Customer Care Center ☎ | Web Site |
|----------------------|-------------------|------------------------------|-----------------------|
| North America | CANADA | 1-800-SAMSUNG (7267864) | www.samsung.com/ca |
| | MEXICO | 01-800-SAMSUNG (7267864) | www.samsung.com/mx |
| | U.S.A | 1-800-SAMSUNG (7267864) | www.samsung.com |
| Latin America | ARGENTINE | 0800-333-3733 | www.samsung.com/ar |
| | BRAZIL | 0800-124-421 | www.samsung.com/br |
| | CHILE | 800-726-7864(SAMSUNG) | www.samsung.com/cl |
| | COSTA RICA | 0-800-507-7267 | www.samsung.com/latin |
| | ECUADOR | 1-800-10-7267 | www.samsung.com/latin |
| | EL SALVADOR | 800-6225 | www.samsung.com/latin |
| | GUATEMALA | 1-800-299-0013 | www.samsung.com/latin |
| | JAMAICA | 1-800-234-7267 | www.samsung.com/latin |
| | PANAMA | 800-7267 | www.samsung.com/latin |
| | PUERTO RICO | 1-800-682-3180 | www.samsung.com/latin |
| | REP. DOMINICA | 1-800-751-2676 | www.samsung.com/latin |
| | TRINIDAD & TOBAGO | 1-800-7267-864 | www.samsung.com/latin |
| | VENEZUELA | 1-800-100-5303 | www.samsung.com/latin |
| Europe | BELGIUM | 02 201 2418 | www.samsung.com/be |
| | CZECH REPUBLIC | 844 000 844 | www.samsung.com/cz |
| | DENMARK | 38 322 887 | www.samsung.com/dk |
| | FINLAND | 09 693 79 554 | www.samsung.com/fi |
| | FRANCE | 08 25 08 65 65 (€ 0,15/Min) | www.samsung.com/fr |
| | GERMANY | 01805 - 121213 (€ 0,14/Min) | www.samsung.de |
| | HUNGARY | 06 40 985 985 | www.samsung.com/hu |
| | ITALIA | 199 153 153 | www.samsung.com/it |
| | LUXEBURG | 02 261 03 710 | www.samsung.lu |
| | NETHERLANDS | 0900 20 200 88 (€ 0.10/Min) | www.samsung.com/nl |
| | NORWAY | 231 627 22 | www.samsung.com/no |
| | POLAND | 0 801 801 881 | www.samsung.com/pl |
| | PORTUGAL | 80 8 200 128 | www.samsung.com/pt |
| | SLOVAKIA | 0850 123 989 | www.samsung.com/sk |
| | SPAIN | 902 10 11 30 | www.samsung.com/es |
| | SWEDEN | 08 585 367 87 | www.samsung.com/se |
| | U.K | 0870 SAMSUNG (7267864) | www.samsung.com/uk |
| | REP. Ireland | 0818 717 100 | www.samsung.com/uk |
| CIS | RUSSIA | 8-800-200-0400 | www.samsung.ru |
| | UKRAINE | 8-800-502-0000 | www.samsung.com/ur |
| Asia Pacific | AUSTRALIA | 1300 362 603 | www.samsung.com/au |
| | CHINA | 800-810-5858, 010- 6475 1880 | www.samsung.com.cn |
| | HONG KONG | 2862 6001 | www.samsung.com/hk |
| | INDIA | 3030 8282 1600 1100 11 | www.samsung.com/in |
| | INDONESIA | 0800-112-8888 | www.samsung.com/id |
| | JAPAN | 0120-327-527 | www.samsung.com/jp |
| | MALAYSIA | 1800-88-9999 | www.samsung.com/my |
| | PHILIPPINES | 1800-10-SAMSUNG (7267864) | www.samsung.com/ph |
| | SINGAPORE | 1800-SAMSUNG (7267864) | www.samsung.com/sg |
| | THAILAND | 1800-29-3232 02-689-3232 | www.samsung.com/th |
| | | TAIWAN | 0800-329-999 |
| | VIETNAM | 1 800 588 889 | www.samsung.com/vn |
| Middle East & Africa | SOUTH AFRICA | 0860 7267864 (SAMSUNG) | www.samsung.com/za |
| | U.A.E | 800SAMSUNG (7267864) | www.samsung.com/mea |



HEADQUARTERS
105 Challenger Road, Ridgefield Park,
N.J.07660-0511
TEL: 1-800-SAMSUNG

SERVICE DIVISION
400 Valley Road, Suite 201
Mount Arlington, NJ 07856

1-800-SAMSUNG (726-7864)
www.samsung.com