





## QUESTIONS OR COMMENTS?

| COUNTRY   | CALL                       | OR VISIT US ONLINE AT                                      | WRITE  |
|-----------|----------------------------|--|--|
| IN THE US | 1-800-SAMSUNG<br>(7267864) | <a href="http://www.samsung.com/us">www.samsung.com/us</a> | Samsung Electronics America, Inc.<br>105 Challenger Road Ridgefield Park,<br>NJ 07660-0511 |

HT-Z310  
HT-TZ312

# Digital Home Theater System user manual

imagine the possibilities

Thank you for purchasing this Samsung product.  
To receive more complete service,  
please register your product at  
[www.samsung.com/global/register](http://www.samsung.com/global/register)



# features

---

## Multi-Disc Playback & FM Tuner

The HT-Z310/HT-TZ312 combines the convenience of multi-disc playback capability, including DVD-AUDIO, DVD-VIDEO, CD, MP3-CD, WMA-CD, DivX, CD-R/RW, and DVD±R/RW, with a sophisticated FM tuner, all in a single player.

## DVD-Audio compatible

Experience the super high-quality audio performance of DVD-Audio. The on-board 24-bit/192kHz DAC enables this player to deliver exceptional sound quality in terms of dynamic range, low-level resolution and high-frequency detail.

## USB Host support

You can enjoy media files such as pictures, movies and music saved on an MP3 player, digital camera or USB memory stick by connecting the storage device to the USB port of the Home Theater.

## Dolby Pro Logic II

Dolby Pro Logic II is a form of multi-channel audio signal decoding technology that improves upon existing Dolby Pro Logic.

## DTS (Digital Theater Systems)

DTS is an audio compression format developed by Digital Theater Systems Inc. It delivers full-frequency 5.1 channel sound.

## TV Screen Saver Function

If the main unit remains in Stop mode for 3 minutes, the Samsung logo appears on the TV screen.

The HT-Z310/HT-TZ312 will automatically switch to the Power Saving mode after 20 minutes in the Screen Saver mode.

## Power Saving Function

The HT-Z310/HT-TZ312 will automatically shut off after 20 minutes in Stop mode.

## Customized TV Screen Display

The HT-Z310/HT-TZ312 allows you to select your favorite image during JPEG or DVD playback and set it as your background wallpaper.

## Anynet+ (HDMI-CEC) Function

Anynet+ is a function that can be used to operate the main unit using a Samsung TV remote control, by connecting the Home Theater to a SAMSUNG TV using an HDMI Cable. (This is only available with SAMSUNG TV's that support Anynet+.)

## iPod support

You can enjoy music files by your connecting iPod to the home theater with the supplied iPod dock.

## AV SYNC Function

Video may lag behind the audio if the unit is connected to a digital TV.

To compensate for this, you can adjust the audio delay time to sync up with the video.

## WHAT'S INCLUDED

---

Check for the supplied accessories below.

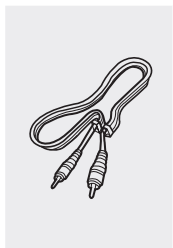

Video Cable  
(AH39-40001V)

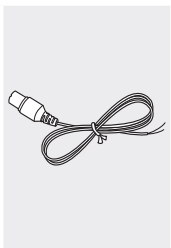

FM Antenna  
(AH42-00017A)

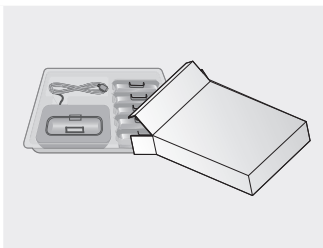

iPod Dock Package  
(AH97-02650A)

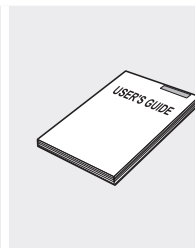

User's Manual  
(AH68-02055R)

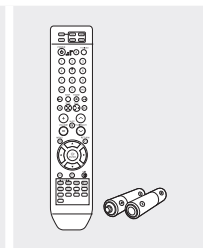



Remote Control  
(AH59-01907B)  
/ Batteries (AAA size)  
(4301-000116)

# safety information

## SAFETY WARNINGS

TO REDUCE THE RISK OF ELECTRIC SHOCK, DO NOT REMOVE THE COVER(OR BACK). NO USER-SERVICEABLE PARTS ARE INSIDE. REFER SERVICING TO QUALIFIED SERVICE PERSONNEL.

|   |   |   |
|---|---|---|
|    | <p style="text-align: center;"><b>CAUTION</b></p> <p style="text-align: center;">RISK OF ELECTRIC SHOCK<br/>DO NOT OPEN</p>   |    |
| <p>The lightning flash and Arrowhead within Triangle is a warning sign alerting you of dangerous voltage inside the product</p> | <p>CAUTION: TO REDUCE THE RISK OF ELECTRIC SHOCK, DO NOT REMOVE COVER (OR BACK) NO USER SERVICEABLE PARTS INSIDE. REFER SERVICING TO QUALIFIED SERVICE PERSONNEL.</p> | <p>The explanation point within the triangle is a warning sign alerting you of important instructions accompanying the product.</p> |

**CLASS 1 LASER PRODUCT**  
**KLASSE 1 LASER PRODUKT**  
**LUOKAN 1 LASER LAITE**  
**KLASS 1 LASER APPARAT**  
**PRODUCTO LASER CLASE 1**

### CLASS 1 LASER PRODUCT

This Compact Disc player is classified as a CLASS 1 LASER product. Use of controls, adjustments or performance of procedures other than those specified herein may result in hazardous radiation exposure.

**CAUTION :** INVISIBLE LASER RADIATION WHEN OPEN AND INTERLOCKS DEFEATED, AVOID EXPOSURE TO BEAM.

### WARNING

- To reduce the risk of fire or electric shock, do not expose this appliance to rain or moisture.
- To prevent injury, this apparatus must be securely attached to the floor/wall in accordance with the installation instructions.
- If this power supply is used at 240V ac, a suitable plug adapter should be used.

### CAUTION

- Apparatus shall not be exposed to dripping or splashing and no objects filled with liquids, such as vases, shall be placed on the apparatus.
- The Mains plug is used as a disconnect device and shall stay readily operable at any time.

This product satisfies FCC regulations when shielded cables and connectors are used to connect the unit to other equipment. To prevent electromagnetic interference with electric appliances, such as radios and televisions, use shielded cables and connectors for connections.

### FCC NOTE (for U.S.A):

This equipment has been tested and found to comply with the limits for a Class B digital device, pursuant to Part 15 of the FCC Rules. These limits are designed to provide reasonable protection against harmful interference in a residential installation.

This equipment generates, uses and can radiate radio frequency energy and, if not installed and used in accordance with the instructions, may cause harmful interference to radio communications. However, there is no guarantee that interference will not occur in a particular installation.

If this equipment does cause harmful interference to radio or television reception, which can be determined by turning the equipment off and on, the user is encouraged to try to correct the interference by one or more of the following measures:

- Reorient or relocate the receiving antenna.
- Increase the separation between the equipment and receiver.
- Connect the equipment into an outlet on a circuit different from that to which the receiver is connected.
- Consult the dealer or an experienced radio/TV technician for help.

**Caution :** FCC regulations state that any unauthorized changes or modifications to this equipment may void the user's authority to operate it.

# safety information

---

## IMPORTANT SAFETY INSTRUCTIONS

---

Read these operating instructions carefully before using the unit. Follow all the safety instructions listed below. Keep these operating instructions handy for future reference.

- 1) Read these instructions.
- 2) Keep these Instructions.
- 3) Heed all warnings.
- 4) Follow all instructions.
- 5) Do not use this apparatus near water.
- 6) Clean only with dry cloth.
- 7) Do not block any ventilation openings. Install in accordance with the manufacturer's instructions.
- 8) Do not install near any heat sources such as radiators, heat registers, stoves, or other apparatus (including amplifiers) that produce heat.
- 9) Do not defeat the safety purpose of the polarized or grounding-type plug. A polarized plug has two blades with one wider than the other. A grounding type plug has two blades and a third grounding prong. The wide blade or the third prong are provided for your safety. If the provided plug does not fit into your outlet, consult an electrician for replacement of the obsolete outlet.
- 10) Protect the power cord from being walked on or pinched particularly at plugs, convenience receptacles, and the point where they exit from the apparatus.
- 11) Only use attachment/accessories specified by the manufacturer.
- 12) Use only with the cart, stand, tripod, bracket, or table specified by the manufacturer, or sold with the apparatus. When a cart is used, use caution when moving the cart/apparatus combination to avoid injury from tip-over.
- 13) Unplug this apparatus during lightning storms or when unused for long periods of time.
- 14) Refer all servicing to qualified service personnel. Servicing is required when the apparatus has been damaged in any way, such as power-supply cord or plug is damaged, liquid has been spilled or objects have fallen into the apparatus, the apparatus has been exposed to rain or moisture, does not operate normally, or has been dropped.



# PRECAUTIONS

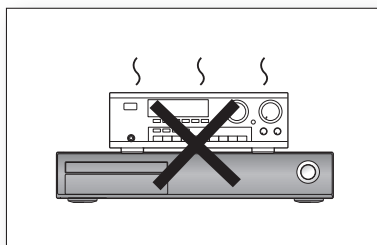
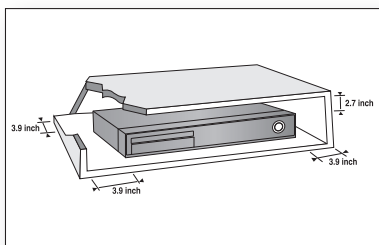

Ensure that the AC power supply in your house complies with the identification sticker located on the back of your player. Install your player horizontally, on a suitable base (furniture), with enough space around it for ventilation (3~4 inches). Make sure the ventilation slots are not covered. Do not stack anything on top of the player. Do not place the player on amplifiers or other equipment which may become hot. Before moving the player, ensure the disc tray is empty. This player is designed for continuous use. Switching off the DVD player to the stand-by mode does not disconnect the electrical supply. In order to disconnect the player completely from the power supply, remove the main plug from the wall outlet, especially when left unused for a long period of time.

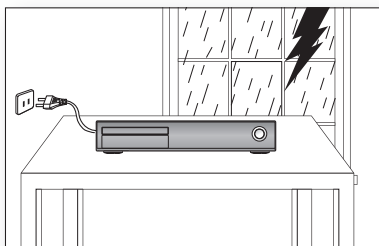

During thunderstorms, disconnect the AC main plug from the wall outlet. Voltage peaks due to lightning could damage the unit.

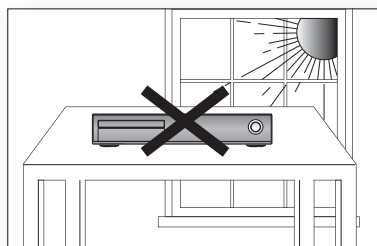

Do not expose the unit to direct sunlight or other heat sources. This could lead to overheating and malfunction of the unit.

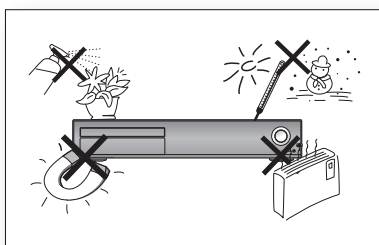

Protect the player from moisture (i.e. vases), and excess heat (e.g. fireplace) or equipment creating strong magnetic or electric fields (i.e. speakers...). Disconnect the power cable from the AC supply if the player malfunctions. Your player is not intended for industrial use. Use of this product is for personal use only.

Condensation may occur if your player or disc has been stored in cold temperatures. If transporting the player during the winter, wait approximately 2 hours until the unit has reached room temperature before using.

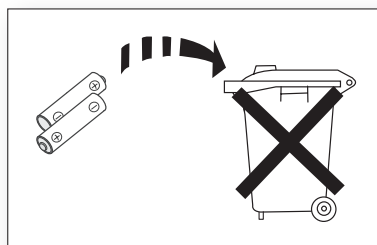

The batteries used with this product contain chemicals that are harmful to the environment. Do not dispose of batteries in the general household trash.

## This product is covered by one or more of the following U.S. patents:

|           |           |           |           |           |           |           |           |           |           |           |
|-----------|-----------|-----------|-----------|-----------|-----------|-----------|-----------|-----------|-----------|-----------|
| 5,060,220 | 5,457,669 | 5,561,649 | 5,705,762 | 5,987,417 | 6,043,912 | 6,222,983 | 6,272,096 | 6,377,524 | 6,377,531 | 6,385,587 |
| 6,389,570 | 6,408,408 | 6,466,532 | 6,473,736 | 6,477,501 | 6,480,829 | 6,556,520 | 6,556,521 | 6,556,522 | 6,578,163 | 6,594,208 |
| 6,631,110 | 6,658,588 | 6,674,697 | 6,674,957 | 6,687,455 | 6,697,307 | 6,707,985 | 6,721,243 | 6,721,493 | 6,728,474 | 6,741,535 |
| 6,744,713 | 6,744,972 | 6,765,853 | 6,765,853 | 6,771,890 | 6,771,891 | 6,775,465 | 6,778,755 | 6,788,629 | 6,788,630 | 6,795,637 |
| 6,810,201 | 6,862,256 | 6,868,054 | 6,894,963 | 6,937,552 |           |           |           |           |           |           |

## This product is covered by the following U.S. patents:

US4,930,158 US4,930,160

# contents

---

|                                       |    |  |
|---------------------------------------|----|--|
| <b>FEATURES</b>                       | 2  | What's included                                      |
| <b>SAFETY INFORMATION</b>             | 3  | Safety Warnings                                      |
|                                       | 4  | Important Safety Instructions                        |
|                                       | 5  | Precautions  |
| <b>GETTING STARTED</b>                | 8  | Before Reading the User's Manual                     |
|                                       | 9  | Playable Discs                                       |
|                                       | 9  | Do not use the following types of disc!              |
|                                       | 9  | Copy Protection                                      |
|                                       | 10 | Disc Type and Characteristics                        |
| <b>DESCRIPTION</b>                    | 11 | Front Panel  |
|                                       | 12 | Display  |
|                                       | 13 | Rear Panel   |
| <b>REMOTE CONTROL</b>                 | 14 | Tour of the Remote Control                           |
|                                       | 16 | Setting the Remote Control                           |
| <b>CONNECTIONS</b>                    | 18 | Connecting the Speakers                              |
|                                       | 23 | Connecting the Optional Wireless Receiving Amplifier |
|                                       | 25 | Connecting the Video Out to your TV                  |
|                                       | 27 | HDMI Function  |
|                                       | 28 | Connecting an iPod                                   |
|                                       | 30 | Connecting Audio from External Components            |
|                                       | 32 | Connecting the FM Antenna                            |
| <b>BEFORE USING YOUR HOME THEATER</b> | 33 | Before using your home theater                       |
| <b>PLAYBACK</b>                       | 34 | Disc Playback  |
|                                       | 35 | MP3/WMA-CD playback                                  |
|                                       | 36 | Jpeg File Playback                                   |
|                                       | 37 | Divx Playback  |
|                                       | 39 | Using The Playback Function                          |
|                                       | 48 | Using the iPod                                       |
|                                       | 49 | Playing Media Files Using The Usb Host Feature       |



**SYSTEM SETUP**

51

- 51 Setting the Language
- 52 Setting TV Screen Type
- 53 Setting Parental Controls (Rating Level)
- 53 Setting the Password
- 54 Setting The Wallpaper
- 54 To Select one of the 3 Wallpaper Settings you've made
- 55 DVD Playback Mode
- 55 Setting the Speaker Mode
- 56 Setting the Delay Time
- 57 Setting the Test Tone
- 57 Setting the Audio
- 58 Setting the DRC (Dynamic Range Compression)
- 59 Setting the AV SYNC
- 59 Setting the HDMI Audio
- 60 Sound field (DSP)/EQ Function
- 60 Dolby Pro Logic II Mode
- 61 Dolby Pro Logic II Effect
- 61 P.BASS

**RADIO**

62

- 62 Listening To Radio
- 62 Presetting Stations

**CONVENIENT FUNCTION**

63

- 63 Sleep Timer Function
- 63 Adjusting Display Brightness
- 63 Mute Function

**TROUBLESHOOTING**

64

- 64 Troubleshooting

**USB HOST FEATURE SUPPORTED PRODUCTS**

66

- 66 Digital Camera
- 66 USB Flash Disc
- 66 MP3 Player

**APPENDIX**

67

- 67 Cautions on Handling and Storing Discs
- 68 Specifications
- 69 Warranty

# getting started

---







## BEFORE READING THE USER'S MANUAL

---

Make sure to check the following terms before reading the user manual.

### Icons that will be used in manual

---

| Icon  | Term    | Definition   |
|---|---------|--|
|  | DVD     | This involves a function available with DVD or DVD-R/DVD-RW discs that have been recorded and finalized in Video Mode. |
|  | CD      | This involves a function available with a data CD (CD-R or CD-RW).   |
|  | MP3     | This involves a function available with CD-R/-RW discs.  |
|  | JPEG    | This involves a function available with CD-R/-RW discs.  |
|  | DivX    | This involves a function available with MPEG4 discs. (DVD±R/RW, CD-R or CD-RW)   |
|  | Caution | This involves a case where a function does not operate or settings may be cancelled.                                   |
|  | Note    | This involves tips or instructions on the page that help each function operate.  |



- In this manual, the instructions marked with "DVD (  )" are applicable to DVD-VIDEO, DVD-AUDIO and DVD-R/-RW discs that have been recorded in Video Mode and then finalized. Where a particular DVD type is mentioned, it is indicated separately.
- If a DVD-R/-RW disc has not been recorded properly in DVD Video format, it will not be playable.

### About the use of this user's manual

---

- 1) Be sure to be familiar with Safety Instructions before using this product. (See pages 3~5)
- 2) If a problem occurs, check the Troubleshooting. (See pages 64~65)

### Copyright

---

©2008 Samsung Electronics Co.,Ltd.

All rights reserved; No part or whole of this user's manual may be reproduced or copied without the prior written permission of Samsung Electronics Co.,Ltd.



**DVD (Digital Versatile Disc)** offers fantastic audio and video, thanks to Dolby Digital surround sound and MPEG-2 video compression technology. Now you can enjoy these realistic effects in the home, as if you were in a movie theater or concert hall.



DVD players and the discs are coded by region. These regional codes must match in order for the disc to play. If the codes do not match, the disc will not play.

The Region Number for this player is given on the rear panel of the player.

(Your DVD player will only play DVDs that are labeled with identical region codes.)

## PLAYABLE DISCS

| Disc Type              | Mark (Logo) | Recorded Signals | Disc Size    | Max. Playing Time               |
|------------------------|-------------|------------------|--------------|---------------------------------|
| DVD-AUDIO<br>DVD-VIDEO |             | AUDIO + VIDEO    | 5 inches     | Approx. 240 min. (single-sided) |
|                        |             |                  |              | Approx. 480 min. (double-sided) |
|                        |             |                  | 3 1/2 inches | Approx. 80 min. (single-sided)  |
|                        |             |                  |              | Approx. 160 min. (double-sided) |
| AUDIO-CD               |             | AUDIO            | 5 inches     | 74 min.                         |
|                        |             |                  | 3 1/2 inches | 20 min.                         |
| DivX                   |             | AUDIO + VIDEO    | 5 inches     | —                               |
|                        |             |                  | 3 1/2 inches | —                               |

## DO NOT USE THE FOLLOWING TYPES OF DISC!

- LD, CD-G, CD-I, CD-ROM, DVD-ROM and DVD-RAM discs cannot be played on this player. If such discs are played, a <WRONG DISC FORMAT> message appears on the TV screen.
- DVD discs purchased abroad may not play on this player. If such discs are played, a <CAN'T PLAY THIS DISC PLEASE, CHECK REGION CODE> message appears on the TV screen.

## COPY PROTECTION

- Many DVD discs are encoded with copy protection. Because of this, you should only connect your DVD player directly to your TV, not to a VCR. Connecting to a VCR results in a distorted picture from copy-protected DVD discs.
- This product incorporates copyright protection technology that is protected by methods claims of certain U.S. patents and other intellectual property rights owned by Macrovision Corporation and other rights owners. Use of this copyright protection technology must be authorized by Macrovision Corporation, and is intended for home and other limited viewing uses only unless otherwise authorized by Macrovision Corporation. Reverse engineering or disassembly is prohibited.

# getting started

---

## DISC TYPE AND CHARACTERISTICS

---

This product does not support Secure (DRM) Media files.

### ❖ CD-R Discs

- Some CD-R discs may not be playable depending on the disc recording device (CD-Recorder or PC) and the condition of the disc.
- Use a 650MB/74 minute CD-R disc.  
Do not use CD-R discs over 700MB/80 minutes as they may not be played back.
- Some CD-RW (Rewritable) media, may not be playable.
- Only CD-Rs that are properly "closed" can be fully played. If the session is closed but the disc is left open, you may not be able to fully play the disc.

### ❖ CD-R MP3 Discs

- Only CD-R discs with MP3 files in ISO 9660 or Joliet format can be played.
- MP3 file names should be 8 characters or less in length and contain no blank spaces or special characters (. / = +).
- Use discs recorded with a compression/decompression data rate greater than 128Kbps.
- Only files with the "mp3" and extensions can be played.
- Only a consecutively written multisession disc can be played. If there is a blank segment in the Multisession disc, the disc can be played only up to the blank segment.
- If the disc is not closed, it will take longer to begin playback and not all of the recorded files may be played.
- For files encoded in Variable Bit Rate (VBR) format, i.e. files encoded in both low bit rate and high bit rate (e.g., 32Kbps ~ 320Kbps), the sound may skip during playback.
- A maximum of 500 tracks can be played per CD.
- A maximum of 300 folders can be played per CD.

### ❖ CD-R JPEG Discs

- Only files with the "jpg" extensions can be played.
- If the disc is not closed, it will take longer to start playing and not all of the recorded files may be played.
- Only CD-R discs with JPEG files in ISO 9660 or Joliet format can be played.
- JPEG file names should be 8 characters or less in length and contain no blank spaces or special characters (. / = +).
- Only a consecutively written multisession disc can be played. If there is a blank segment in the multisession disc, the disc can be played only up to the blank segment.
- A maximum of 9,999 images can be stored on a single CD.
- When playing a Kodak/Fuji Picture CD, only the JPEG files in the picture folder can be played.
- Picture discs other than Kodak/Fuji Picture CDs may take longer to start playing or may not play at all.

### ❖ DVD±R/RW, CD-R/RW DivX Discs

- Since this product only provides encoding formats authorized by DivX Networks, Inc., a DivX file created by the user might not play.
- Software updates for incompatible formats are not supported.  
(Example : QPEL, GMC, resolution higher than 800 x 600 pixels, etc.)
- Sections with a high frame rate might not be played while playing a DivX file.
- For more information about the formats authorized by DivX Networks, Inc., please visit "[www.divxnetworks.net](http://www.divxnetworks.net)".

# description

## FRONT PANEL

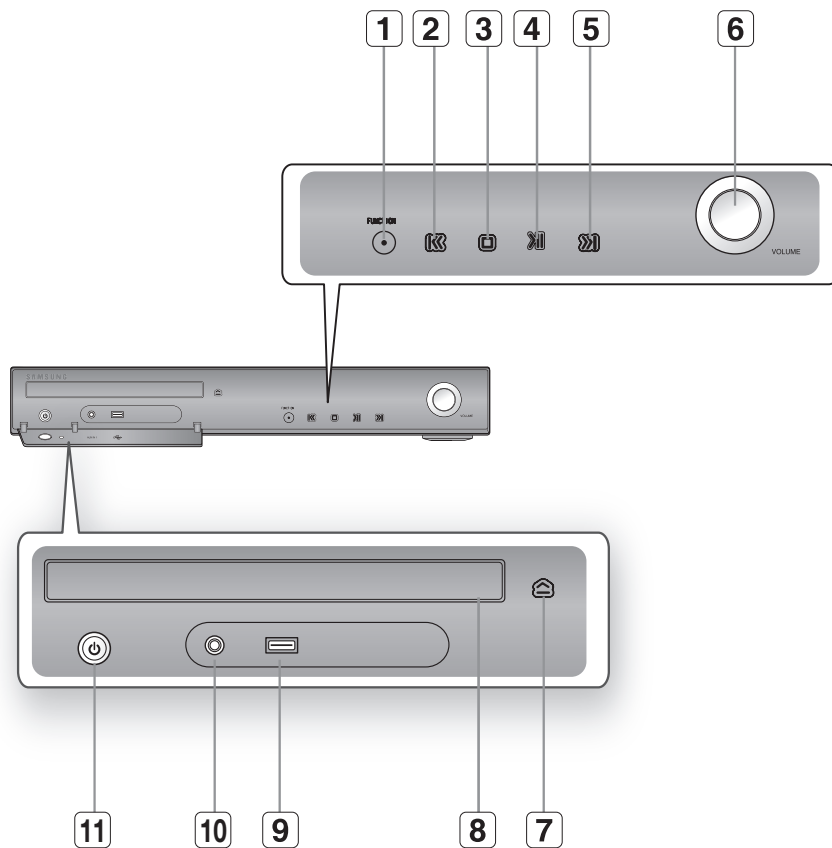

|  |                                      |                              |
|--|--------------------------------------|------------------------------|
| <b>1</b> FUNCTION BUTTON               | <b>5</b> TUNING UP & SKIP (⏭) BUTTON | <b>9</b> USB CONNECTOR       |
| <b>2</b> TUNING DOWN & SKIP (⏮) BUTTON | <b>6</b> VOLUME CONTROL              | <b>10</b> AUX IN 1 CONNECTOR |
| <b>3</b> STOP (■) BUTTON               | <b>7</b> OPEN/CLOSE BUTTON           | <b>11</b> POWER (⏻) BUTTON   |
| <b>4</b> PLAY/PAUSE (⏯) BUTTON         | <b>8</b> DISC TRAY                   |                              |

# description

## DISPLAY

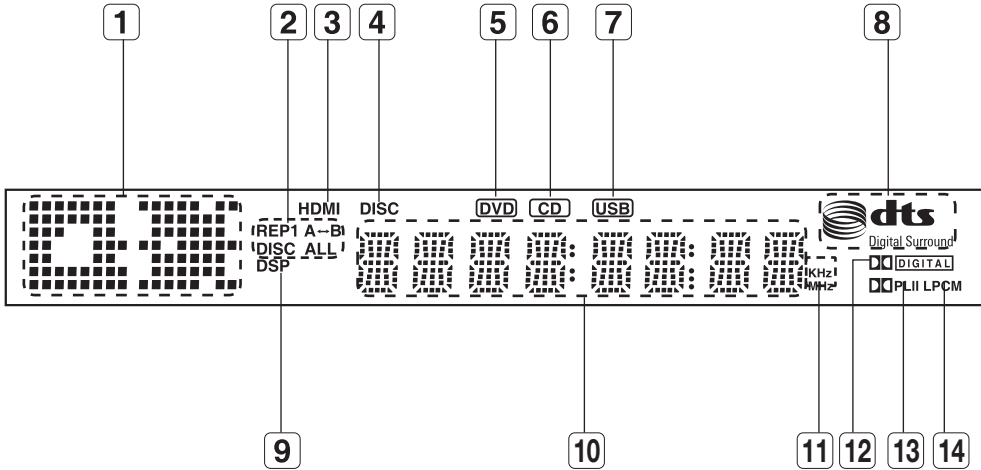

|          |                  |           |                       |           |                           |
|----------|------------------|-----------|-----------------------|-----------|---------------------------|
| <b>1</b> | FUNCTION DISPLAY | <b>6</b>  | CD INDICATOR          | <b>11</b> | RADIO FREQUENCY INDICATOR |
| <b>2</b> | REPEAT INDICATOR | <b>7</b>  | USB INDICATOR         | <b>12</b> | DOLBY DIGITAL INDICATOR   |
| <b>3</b> | HDMI INDICATOR   | <b>8</b>  | DTS DISC INDICATOR    | <b>13</b> | PRO LOGIC INDICATOR       |
| <b>4</b> | DISC INDICATOR   | <b>9</b>  | DSP INDICATOR         | <b>14</b> | LPCM INDICATOR            |
| <b>5</b> | DVD INDICATOR    | <b>10</b> | SYSTEM STATUS DISPLAY |           |                           |

## REAR PANEL

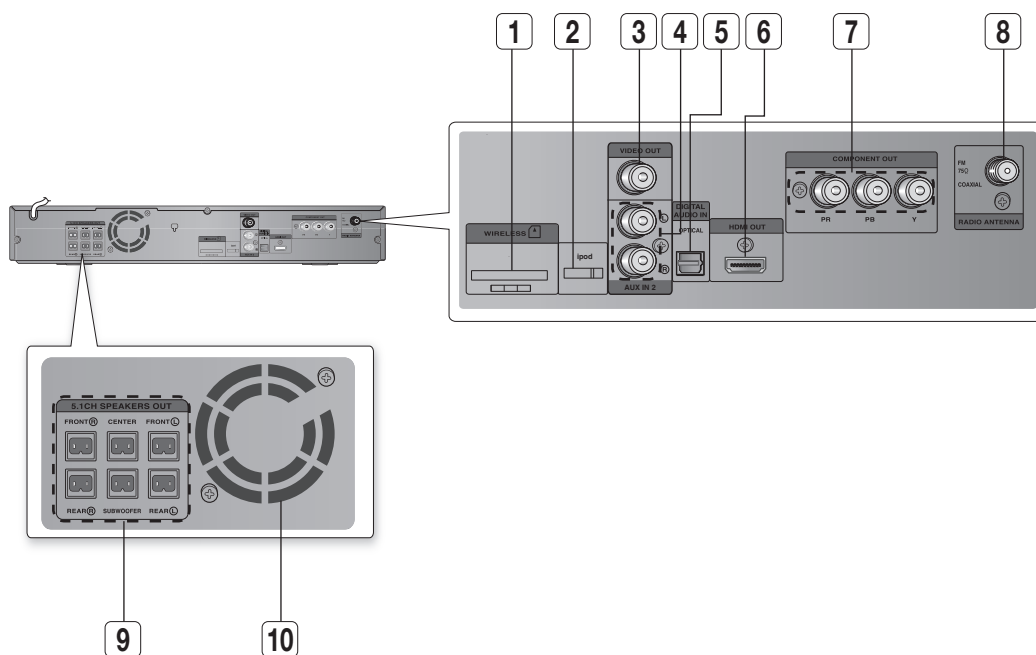



|           |  |  |
|-----------|--|--|
| <b>1</b>  | <b>TX CARD CONNECTION (WIRELESS)</b>       | The TX card enables communication between the main unit and the optional wireless receiver amplifier.  |
| <b>2</b>  | <b>iPod JACK</b>                           | Connect the iPod dock connector here.  |
| <b>3</b>  | <b>VIDEO OUTPUT JACK</b>                   | Connect the TV's Video Input jack (VIDEO IN) to the VIDEO OUT jack.  |
| <b>4</b>  | <b>AUX IN 2 JACKS</b>                      | Connect to the 2CH analog output of an external device (such as a VCR)   |
| <b>5</b>  | <b>External Digital Optical Input Jack</b> | Use this to connect external equipment capable of digital output.  |
| <b>6</b>  | <b>HDMI OUT JACK</b>                       | Use the HDMI cable, connect this HDMI output terminal to the HDMI input terminal on your TV for the best quality picture.                      |
| <b>7</b>  | <b>COMPONENT VIDEO OUTPUT JACKS</b>        | Connect a TV with Component video inputs to these jacks.   |
| <b>8</b>  | <b>FM 75Ω COAXIAL JACK</b>                 | Connect the FM antenna.  |
| <b>9</b>  | <b>SPEAKER OUTPUT CONNECTORS</b>           | Connect the front, center, rear speakers and subwoofer.  |
| <b>10</b> | <b>COOLING FAN</b>                         | The fan always revolves when the power is on. Ensure a minimum of 4 inches of clear space on all sides of the fan when installing the product. |

# remote control

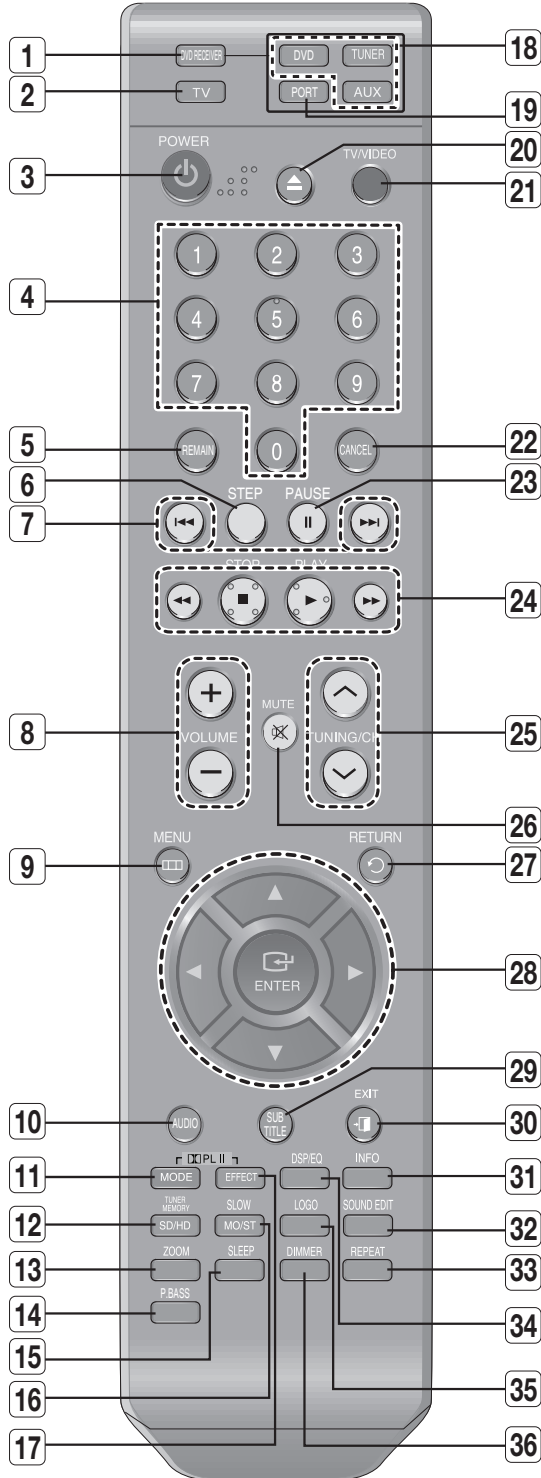
## TOUR OF THE REMOTE CONTROL





|           |  |           |                     |
|-----------|--|-----------|---------------------|
| <b>1</b>  | DVD RECEIVER button  | <b>19</b> | PORT button         |
| <b>2</b>  | TV button  | <b>20</b> | ⏏ OPEN/CLOSE button |
| <b>3</b>  | POWER button   | <b>21</b> | TV/VIDEO button     |
| <b>4</b>  | Number (0-9) buttons   | <b>22</b> | CANCEL button       |
| <b>5</b>  | REMAIN button  | <b>23</b> | PAUSE button        |
| <b>6</b>  | STEP button  |           | ▶ PLAY button       |
| <b>7</b>  | Tuning Preset/CD Skip buttons  | <b>24</b> | ■ STOP button       |
| <b>8</b>  | VOLUME button  |           | ◀▶ SEARCH buttons   |
| <b>9</b>  | MENU button  | <b>25</b> | TUNING/CH button    |
| <b>10</b> | AUDIO button   | <b>26</b> | MUTE button         |
| <b>11</b> | ⏏ PL II MODE button  | <b>27</b> | RETURN button       |
| <b>12</b> | TUNER MEMORY, SD(Standard Definition)/HD(High Definition) button                                 | <b>28</b> | Cursor/ENTER button |
| <b>13</b> | ZOOM button  | <b>29</b> | SUBTITLE button     |
| <b>14</b> | P.BASS button  | <b>30</b> | EXIT button         |
| <b>15</b> | SLEEP button   | <b>31</b> | INFO button         |
| <b>16</b> | SLOW, MO/ST button   | <b>32</b> | SOUND EDIT button   |
| <b>17</b> | ⏏ PL II EFFECT button  | <b>33</b> | REPEAT button       |
| <b>18</b> |  DVD button   | <b>34</b> | DSP/EQ button       |
|           |  TUNER button | <b>35</b> | LOGO button         |
|           |  AUX button   | <b>36</b> | DIMMER button       |

## Insert Remote Batteries

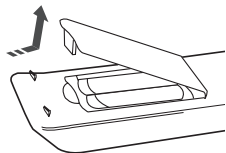

**1. Remove the battery cover in the direction of the arrow.**

**2. Insert two 1.5V AAA batteries, paying attention to the correct polarities (+ and -).**

**3. Replace the battery cover.**



### Follow these precautions to avoid leaking or cracking cells:

- Place batteries in the remote control so they match the polarity : (+) to (+) and (-) to (-).
- Use the correct type of batteries. Batteries that look similar may differ in voltage.
- Always replace both batteries at the same time.
- Do not expose the batteries to heat or a flame.

# remote control

## SETTING THE REMOTE CONTROL

You can control certain functions of your TV with this remote control.

### When operating a TV with the remote control

1. Press the **TV** button to set the remote to TV mode.
2. Press the **POWER** button to turn on the TV.
3. While holding down the **POWER** button, enter the code corresponding to your brand of TV.
  - If there is more than one code listed for your TV in the table, enter one at a time to determine which code works.

#### Example : For a Samsung TV

While holding down the **POWER** button, use the **number** buttons to enter 00, 15, 16, 17 or 40.

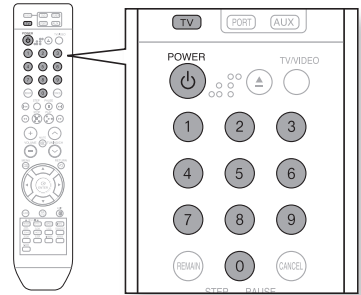

4. If the TV turns off, the setting is complete.
  - You can use the TV POWER, VOLUME, CHANNEL, and Numeric buttons (0~9).



- The remote control may not work on some brands of TVs. Also, some operations may not be possible depending on your brand of TV.
- If you do not set the remote control with the code for your brand of TV, the remote control will work on a Samsung TV by default.

### Operation Range of the Remote Control

The remote control can be used up to approximately 23 feet (7 meters) in a straight line. It can also be operated at a horizontal angle of up to 30° from the remote control sensor.

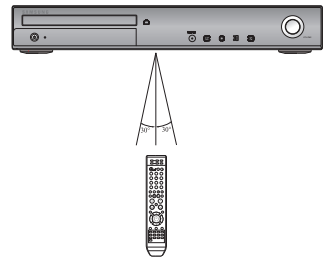

## TV Brand Code List

| No. | Brand                   | Code  | No. | Brand                    | Code                                    |
|-----|-------------------------|---|-----|--------------------------|---|
| 1   | Admiral (M.Wards)       | 56, 57, 58  | 44  | MTC                      | 18                                      |
| 2   | A Mark                  | 01, 15  | 45  | NEC                      | 18, 19, 20, 40, 59, 60                  |
| 3   | Anam                    | 01, 02, 03, 04, 05, 06, 07, 08, 09, 10, 11,         | 46  | Nikei                    | 03                                      |
|     |                         | 12, 13, 14  | 47  | Onking                   | 03                                      |
| 4   | AOC                     | 01, 18, 40, 48                                      | 48  | Onwa                     | 03                                      |
| 5   | Bell & Howell (M.Wards) | 57, 58, 81  | 49  | Panasonic                | 06, 07, 08, 09, 54, 66, 67, 73, 74      |
| 6   | Brocsonic               | 59, 60  | 50  | Penney                   | 18                                      |
| 7   | Candle                  | 18  | 51  | Philco                   | 03, 15, 17, 18, 48, 54, 59, 62, 69, 90  |
| 8   | Cetronic                | 03  | 52  | Philips                  | 15, 17, 18, 40, 48, 54, 62, 72          |
| 9   | Citizen                 | 03, 18, 25  | 53  | Pioneer                  | 63, 66, 80, 91                          |
| 10  | Cinema                  | 97  | 54  | Portland                 | 15, 18, 59                              |
| 11  | Classic                 | 03  | 55  | Proton                   | 40                                      |
| 12  | Concerto                | 18  | 56  | Quasar                   | 06, 66, 67                              |
| 13  | Contec                  | 46  | 57  | Radio Shack              | 17, 48, 56, 60, 61, 75                  |
| 14  | Coronado                | 15  | 58  | RCA/Proscan              | 18, 59, 67, 76, 77, 78, 92, 93, 94      |
| 15  | Craig                   | 03, 05, 61, 82, 83, 84                              | 59  | Realistic                | 03, 19                                  |
| 16  | Croslex                 | 62  | 60  | Sampo                    | 40                                      |
| 17  | Crown                   | 03  | 61  | Samsung                  | 00, 15, 16, 17, 40, 43, 46, 47, 48, 49, |
| 18  | Curtis Mates            | 59, 61, 63  |     |                          | 59, 60, 98                              |
| 19  | CXC                     | 03  | 62  | Sanyo                    | 19, 61, 65                              |
| 20  | Daewoo                  | 02, 03, 04, 15, 16, 17, 18, 19, 20, 21, 22, 23, 24, | 63  | Scott                    | 03, 40, 60, 61                          |
|     |                         | 25, 26, 27, 28, 29, 30, 32, 34, 35, 36, 48, 59, 90  | 64  | Sears                    | 15, 18, 19                              |
| 21  | Daytron                 | 40  | 65  | Sharp                    | 15, 57, 64                              |
| 22  | Dynasty                 | 03  | 66  | Signature 2000 (M.Wards) | 57, 58                                  |
| 23  | Emerson                 | 03, 15, 40, 46, 59, 61, 64, 82, 83, 84, 85          | 67  | Sony                     | 50, 51, 52, 53, 55                      |
| 24  | Fisher                  | 19, 65  | 68  | Soundesign               | 03, 40                                  |
| 25  | Funai                   | 03  | 69  | Spectricon               | 01                                      |
| 26  | Futuretech              | 03  | 70  | SSS                      | 18                                      |
| 27  | General Electric (GE)   | 06, 40, 56, 59, 66, 67, 68                          | 71  | Sylvania                 | 18, 40, 48, 54, 59, 60, 62              |
| 28  | Hall Mark               | 40  | 72  | Symphonic                | 61, 95, 96                              |
| 29  | Hitachi                 | 15, 18, 50, 59, 69                                  | 73  | Tatung                   | 06                                      |
| 30  | Inkel                   | 45  | 74  | Techwood                 | 18                                      |
| 31  | JC Penny                | 56, 59, 67, 86                                      | 75  | Teknika                  | 03, 15, 18, 25                          |
| 32  | JVC                     | 70  | 76  | TMK                      | 18, 40                                  |
| 33  | KTV                     | 59, 61, 87, 88                                      | 77  | Toshiba                  | 19, 57, 63, 71                          |
| 34  | KEC                     | 03, 15, 40  | 78  | Vidtech                  | 18                                      |
| 35  | KMC                     | 15  | 79  | Videch                   | 59, 60, 69                              |
| 36  | LG (Goldstar)           | 01, 15, 16, 17, 37, 38, 39, 40, 41, 42, 43, 44      | 80  | Wards                    | 15, 17, 18, 40, 48, 54, 60, 64          |
| 37  | Luxman                  | 18  | 81  | Yamaha                   | 18                                      |
| 38  | LXI (Sears)             | 19, 54, 56, 59, 60, 62, 63, 65, 71                  | 82  | York                     | 40                                      |
| 39  | Magnavox                | 15, 17, 18, 48, 54, 59, 60, 62, 72, 89              | 83  | Yupiteru                 | 03                                      |
| 40  | Marantz                 | 40, 54  | 84  | Zenith                   | 58, 79                                  |
| 41  | Matsui                  | 54  | 85  | Zonda                    | 01                                      |
| 42  | MGA                     | 18, 40  | 86  | Dongyang                 | 03, 54                                  |
| 43  | Mitsubishi/MGA          | 18, 40, 59, 60, 75                                  |     |                          |   |

# connections

---

This section involves various methods of connecting the Digital Home Theater to other external components. Before moving or installing the product, be sure to turn off the power and disconnect the power cord.

## CONNECTING THE SPEAKERS

---

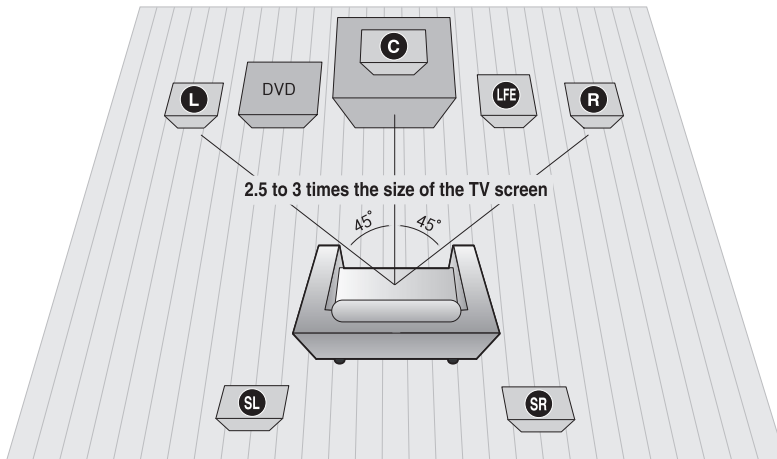

### Position of the DVD Player

Place it on a stand or cabinet shelf, or under the TV stand.

### Selecting the Listening Position

The listening position should be located about 2.5 to 3 times the distance of the TV's screen size away from the TV.

Example : For 32" TVs 2~2.4m (6~8feet)

For 55" TVs 3.5~4m (11~13feet)

### Front Speakers **L** **R**

Place these speakers in front of your listening position, facing inwards (about 45°) toward you.

Place the speakers so that their tweeters will be at the same height as your ear.

Align the front face of the front speakers with the front face of the center speaker or place them slightly in front of the center speakers.

### Center Speaker **C**

It is best to install it at the same height as the front speakers. You can also install it directly over or under the TV.

### Rear Speakers **SL** **SR**

Place these speakers behind your listening position. If there isn't enough room, place these speakers so they face each other. Place them about 60 to 90cm (2 to 3feet) above your ear, facing slightly downward.

★ Unlike the front and center speakers, the rear speakers are used to handle mainly sound effects and sound will not come from them all the time.

### Subwoofer **LFE**

The position of the subwoofer is not so critical. Place it anywhere you like.

Speaker Components

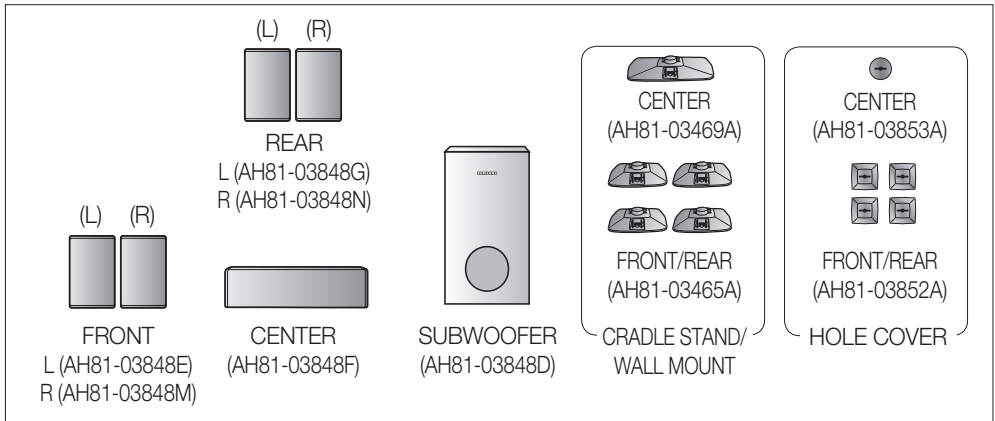

Installing the Cradle Stand

1. Insert the stand so that it fits into the hole as described in the figure.

<Front/Rear>

<Center>

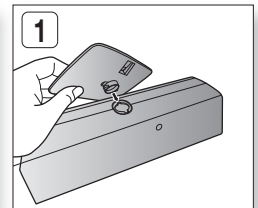
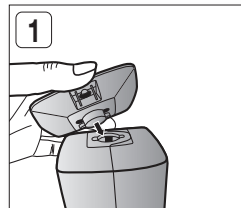

2. Turn the stand clockwise to lock it. (Turning it counter-clockwise will loosen from the hole.)

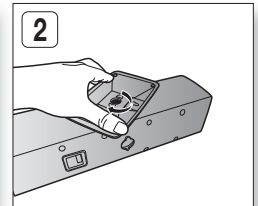
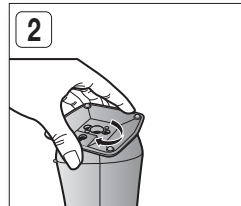

3. This is the completion of the stand installation.

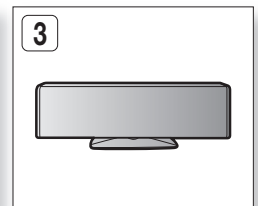
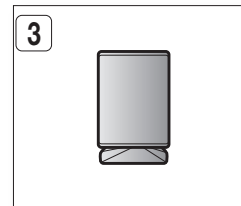

# connections

## CONNECTING THE SPEAKERS (CON'T)

### Installing the Wall Mount

1. Insert the wall mount so that it fits into the rear hole of the speaker as in the figure.

<Front/Rear>

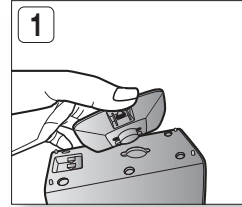

<Center>

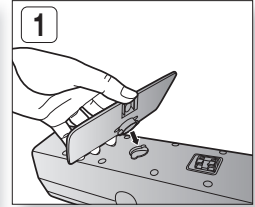

2. Turn the wall mount counter clockwise to fix it. (This is the reverse direction to the cradle stand.)

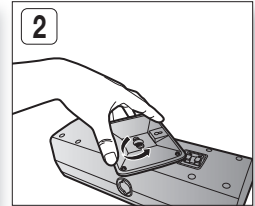
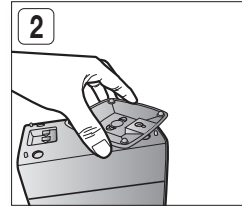

3. Put the hole cover on the hole of the speaker.

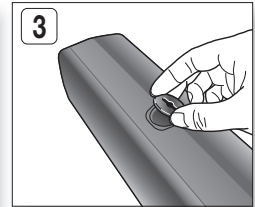
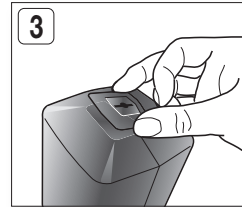

4. Use a coin turn the hole cover clockwise to fix it. (Turning it count-clockwise will loosen from the hole.)

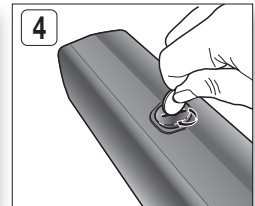
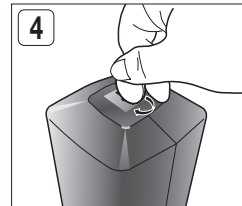

5. Use the wall mount hole (bracket) to install the speaker on the wall.

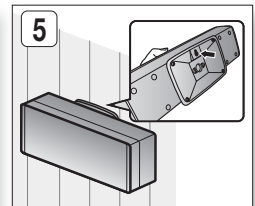
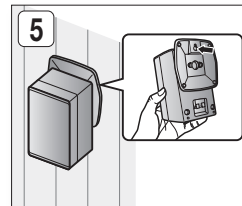

- To avoid accident fall and consequent damage to the customer and speaker, make sure the speaker is hung safely.

Speaker Components

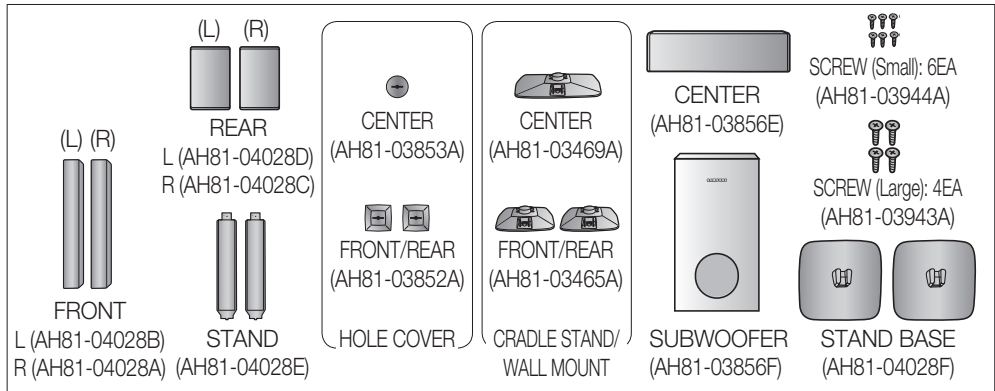

How to Install the Speaker on the Stand

1. Turn the **STAND** upside-down and connect it to the **STAND BASE**.
2. Insert three small **SCREWS** into three holes marked with arrows using a screwdriver as shown in the illustration.
3. Insert a large **SCREW** into the hole on the rear of the Speaker **STAND**.
4. Connect the assembled stand to the **SPEAKER**.
5. Insert another large **SCREW** into the hole on the rear of the speaker using a screwdriver as shown in the illustration.
6. This is the successfully assembled speaker. Make sure that the speaker is installed on a flat and stable area. Otherwise it may be easily knocked over.

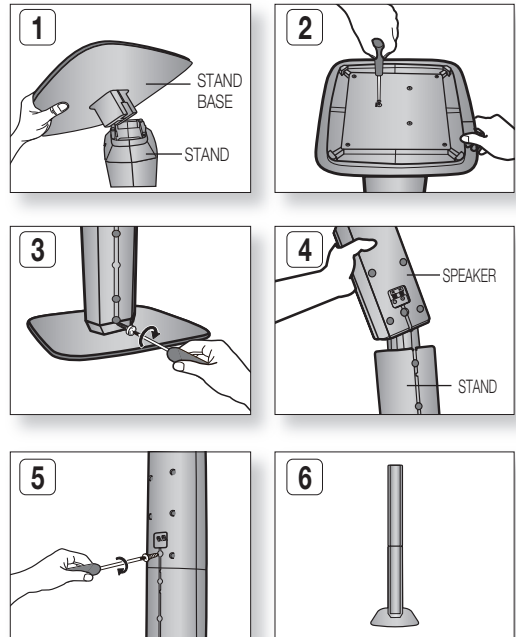

How to Install the Speaker on the Stand Base

1. Connect the **SPEAKER** with the **STAND BASE**.
2. Insert the **SCREW** into the hole on the rear of the speaker using a screwdriver as shown in the illustration.
3. This is the **SPEAKER** successfully assembled with the Stand Base.

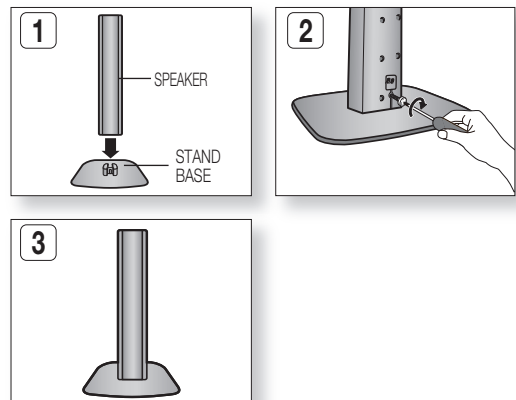

# connections

## CONNECTING THE SPEAKERS (CON'T)

### Connecting the Front, Rear, Center and Subwoofer Speakers

1. Press down the terminal tab on the back of the speaker.
2. Insert the black wire into the black terminal (-) and the red wire into the red (+) terminal, and then release the tab.
3. Connect the connecting plugs to the back of the Home Theater.
  - Make sure the colors of the speaker terminals match the colors of the connecting plugs.

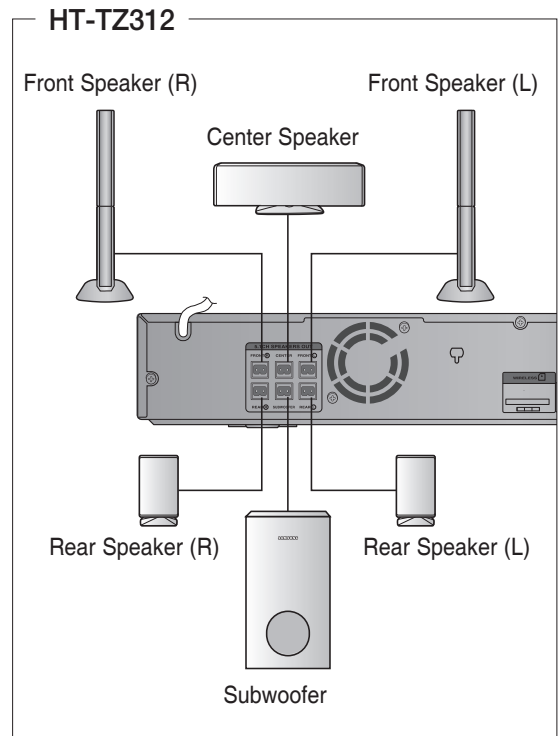
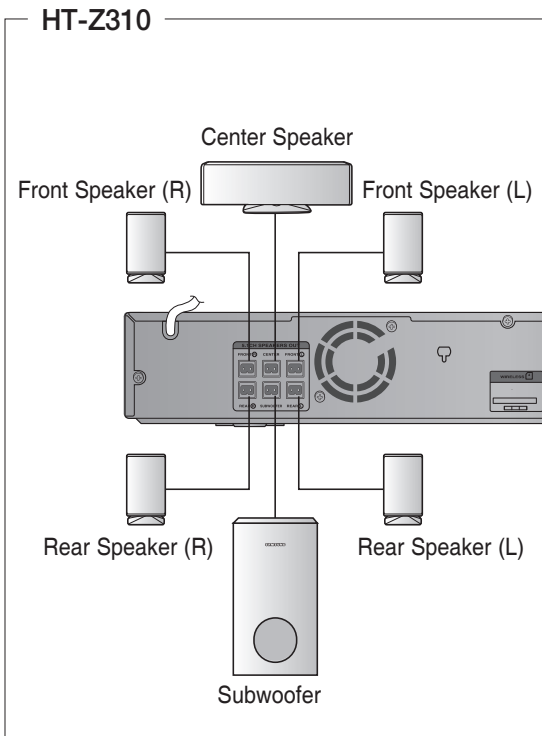
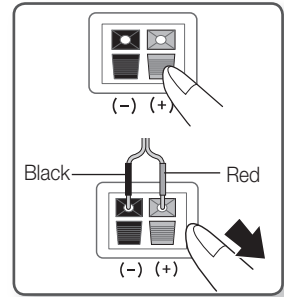



- ! Do not let children play with or near the speakers. They could get hurt if a speaker falls.
- When connecting the speaker wires to the speakers, make sure that the polarity (+/-) is correct.
- Keep the subwoofer speaker out of reach of children so as to prevent children from inserting their hands or alien substances into the duct (hole) of the subwoofer speaker.
- Do not hang the subwoofer on a wall through the duct (hole).

- ✍ If you place a speaker near your TV set, screen color may be distorted because of the magnetic field generated by the speaker. If this occurs, place the speaker away from your TV set.

## CONNECTING THE OPTIONAL WIRELESS RECEIVING AMPLIFIER

### Wireless Receiving Module (SWA-4000)

In case of HT-Z310

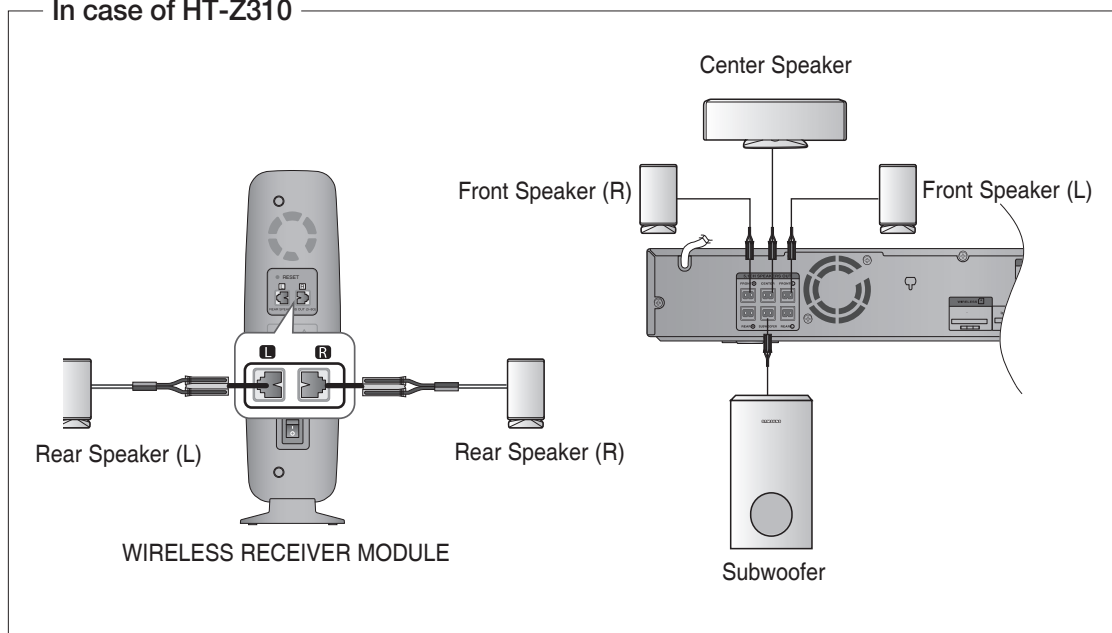

1. Connect the front, center and Subwoofer speakers to the DVD Player, referring to pages 22.
2. With the DVD Player turned off, insert the TX card into the TX Card Connection(WIRELESS) on the back of the main unit.
  - Hold the TX card so that the slanted side faces to the left and insert the card into the port.
  - The TX card enables communication between the main unit and the wireless receiver.
3. Connect the left and right rear speakers to the wireless receiving module.

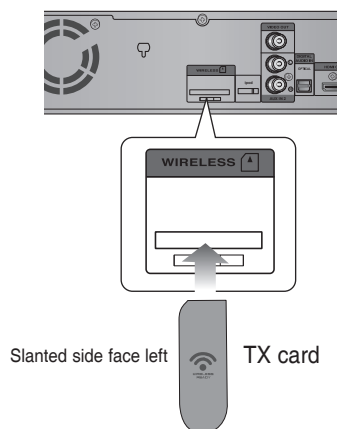

# connections

---

## CONNECTING THE OPTIONAL WIRELESS RECEIVING AMPLIFIER (CON'T)

---

### When you have Purchased the Wireless Receiving Module (SWA-4000)

---

4. Plug the power cord of the wireless receiving module in the wall outlet and switch the power switch **ON**.

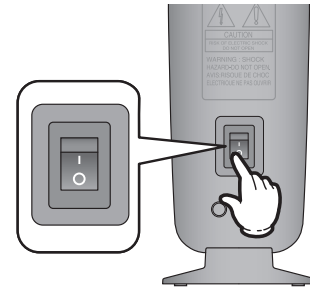

- 
- Place the wireless receiver module at the rear of the listening position. If the wireless receiver module is too close to the main unit, some sound interruption may be heard due to interference.
  - If you use a device such as a microwave oven, wireless LAN Card, Bluetooth equipment, or any other device that uses the same frequency (5.8GHz) near the system, some sound interruption may be heard due to interference.
  - The transmission distance from the main unit to the wireless receiving module is about 33 feet (10m), but may vary depending on your operating environment. If a steel-concrete wall or metallic wall is between the main unit and the wireless receiver module, the system may not operate at all, because the radio wave cannot penetrate metal.
  - This product(HT-Z310/HT-TZ312) is compatible with the wireless receiver module SWA-3000.

- 
- Do not insert any other card except the TX card dedicated to the product. If a different TX card is used, the product may be damaged or the card may not be removed easily.
  - Do not insert the TX card upside down or in the reverse direction.
  - Insert the TX card when the DVD Player is turned off. Inserting the card when it is turned on may cause a problem.
  - If the TX Card is inserted and wireless receiving module setting is complete, sound is not output from the Rear Speaker connectors on the main unit.
  - The wireless receiving antenna is built into the wireless receiver module. Keep the unit away from water and moisture.
  - For optimal listening performance, make sure that the area around the wireless receiver module location is clear of any obstructions.
  - **If no sound is heard from the wireless rear speakers, switch the mode to DVD 5.1 channel or Dolby ProLogic II .**
  - In 2-CH mode, no sound will be heard from the wireless rear speakers.

## CONNECTING THE VIDEO OUT TO YOUR TV

Choose one of the three methods for connecting to a TV.

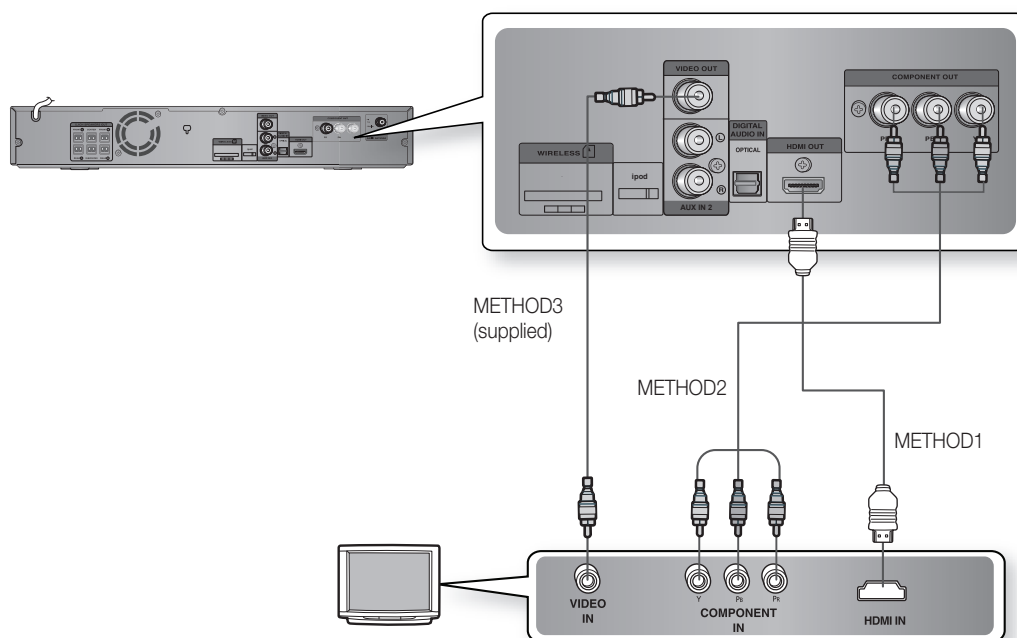

### METHOD 1 : HDMI

Connect the HDMI cable from the HDMI OUT jack on the back of the DVD Home Theater to the HDMI IN jack on your TV.

### METHOD 2 : Component Video

If your television is equipped with Component Video inputs, connect a component video cable(not supplied) from the Component Video Output (Pr, Pb and Y) Connectors on the back of the main unit to the Component Video Input Connectors on your TV.

### METHOD 3 : Composite Video

Connect the supplied video cable from the VIDEO OUT jack on the back of the main unit to the VIDEO IN jack on your TV.



- Resolutions available for the HDMI output are 480p, 720p, 1080i/1080p.
- This product operates in Interlace scan mode (480i) for Component Output.
- After making the video connection, set the Video input source on your TV to match the corresponding Video output (HDMI, Component or Composite) on your Home theater. See your TV owner's manual for more information on how to select the TV's Video Input source.
- If you use an HDMI cable to connect a Samsung TV to the main unit, you can operate the Home Theater using the TV's remote control. (This is only available with SAMSUNG TVs that support Anynet+(HDMI-CEC).)
- Please check the **Anynet+** logo (If your TV has an **Anynet+** logo, then it supports Anynet+ function.)

## CONNECTING THE VIDEO OUT TO YOUR TV (CON'T)

---

### HDMI Auto Detection Function

---

The player's video output will automatically change to HDMI mode when connecting an HDMI cable while power is on. For possible HDMI resolutions, see page 27.

- **HDMI (High Definition Multimedia Interface)**

HDMI is an interface that enables the digital transmission of video and audio data with just a single connector. Using HDMI, the DVD Home Theater transmits a digital video and audio signal and displays a vivid picture on a TV having an HDMI input jack.

- **HDMI connection description**

HDMI connector - Supports video and digital audio data.

- HDMI outputs only a pure digital signal to the TV.

- If your TV does not support HDCP (High-bandwidth Digital Content Protection), random noise appears on the screen.

- **Why does Samsung use HDMI?**

Analog TVs require an analog video/audio signal. However, when playing a DVD, the data transmitted to a TV is digital. Therefore either a digital-to-analog converter (in the DVD Home Theater) or an analog-to-digital converter (in the TV) is required. During this conversion, the picture quality is degraded due to noise and signal loss. HDMI technology is superior because it requires no D/A conversion and is a pure digital signal from the player to your TV.

- **What is the HDCP?**

HDCP (High-band width Digital Content Protection) is a system for protecting DVD content outputted via HDMI from being copied. It provides a secure digital link between a video source (PC, DVD, etc) and a display device (TV, projector, etc). Content is encrypted at the source device to prevent unauthorized copies from being made.

- **What is Anynet+?**

Anynet+ is a convenient function that offers linked operation of this unit through Samsung TVs with the Anynet+ feature.

- If your Samsung TV has an  logo, then it supports the Anynet+ function.

- If you turn on the player and insert a disc, the player will start playing the disc, and the TV will turn on automatically and switch to HDMI mode.

- If you turn on the player and press the Play button with a disc already inserted, the TV will immediately turn on and switch to HDMI mode.

## HDMI FUNCTION

### Resolution Selection

This function allows the user to select the screen resolution for HDMI output.

In Stop mode, press and hold the **SD/HD** (Standard Definition/High Definition) button on the remote control.

- Resolutions available for the HDMI output are 480p, 720p, 1080i/1080p.
- SD(Standard Definition) resolution is 480p and HD (High Definition) resolution is 720p, 1080i/1080p.

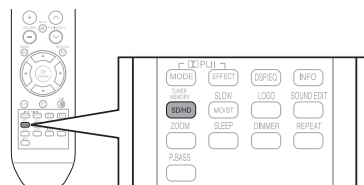

- If the TV does not support the configured resolution, you will not be able to see the picture properly.
- When an HDMI cable is connected, composite and component video signals are not output.
- See your TV owner's manual for more information on how to select the TV's Video Input source.

#### Why use HDMI (High Definition Multimedia Interface)?

This device transmits a DVD video signal digitally without the process of converting to analog. You will get sharper digital pictures when using an HDMI connection.

### Using Anynet+(HDMI-CEC)

Anynet+ is a function that enables you to control other Samsung Devices with your Samsung TV's remote control, Anynet + can be used by connecting this Home Theater to a SAMSUNG TV using an HDMI Cable. This is only available with SAMSUNG TVs that support Anynet+.

1. Connect the main unit of the Home Theater to a Samsung TV with an HDMI cable. (See page 25)
2. Set the Anynet+ function on your TV.  
(See the TV instruction manual for more information.)
  - You can operate the Home Theater by using the TV remote control. (Available TV buttons : ◀, ■, ▶, ▶▶, ▲, ▼ and ◀▶ buttons, 0 ~ 9 button)

#### With Anynet+

You can operate this unit, power on your TV, or watch a movie by pressing the Play button on your Samsung TV's remote control.

#### If you select the TV

Set the Anynet+(HDMI-CEC) to On by pressing the Anynet+ button on your TV remote control.

- **Receiver : On** : You can listen to audio through the Home Theater.
- **Receiver : Off** : You can listen to audio through the TV.

#### If you select the THEATER

Select **THEATER to connect** and set the option of each item below.

- **View TV** : If anynet+(HDMI CEC) is set to on and you select View TV, the home theater will automatically switch to digital in mode.
- **Theater Menu** : you can access and control the Home theater menu.
- **Theater Operation** : The Home Theater disc playback information will be displayed. You can control the Disc operation of the Home Theater such as title, chapter and subtitle change.
- **Receiver : On** : You can listen to audio through the Home Theater.
- **Receiver : Off** : You can listen to audio through the TV.



- In case that you chose 'View TV', if you want to listen to TV sound through Digital In, you have to connect the optical cable between the TV and the Home Theater.

# connections

## CONNECTING AN iPod

You can listen to the audio from an iPod through the main unit. For iPod operation with this Home Theater, see pages 31 and 48.

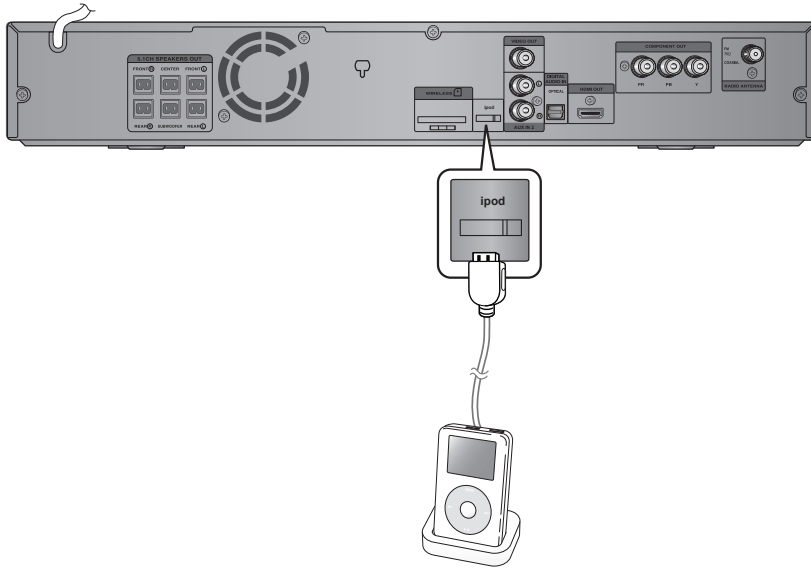







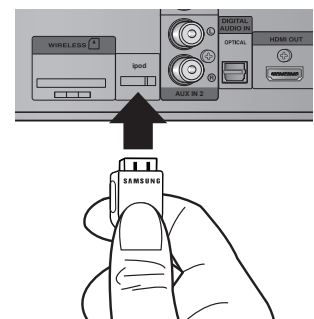

1. Connect the iPod dock connector to the iPod jack on the DVD home theater.
2. Press the **PORT** button on the remote control to select **iPod** input.
  - You can also use the **FUNCTION** button on the main unit.The mode switches as follows :  
**DVD/CD → D.IN → AUX 1 → AUX 2 → USB → OSD IPOD → FM.**











- As the cable ports are close together, be sure to remove the wireless adaptor before disconnecting the ipod docking cable.
- Depending on the type of iPod. You may need to insert one of the dock slots into the dock before you station your iPod (see next page).
- Adjust the volume to a moderate level before you connect your iPod and DVD home theater.
- When the unit is powered on and you connect an iPod, the unit will charge your iPod's battery.
- Make sure to connect the dock connector so that the label "**SAMSUNG**" faces upward.

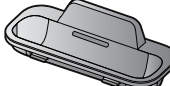

## iPod models compatible with the dock

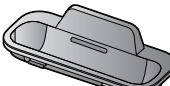
|  |   |   |
|--|---|---|
|  mini (4GB, 6GB)                    |  20GB                          |  40GB                    |
|  20GB, 30GB<br>(color display)      |  40GB, 60GB<br>(color display) |  nano<br>(1GB, 2GB, 4GB) |
|  nano (aluminum)<br>(2GB, 4GB, 8GB) |  30GB (video)                  |  60GB, 80GB (video)      |

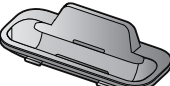
The following 5 models must be used with the applicable dock insert as well as the dock before they can be connected to the system.

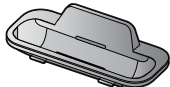
|   |   |   |  |   |   |
|---|---|---|--|---|---|
|  iPhone (4GB, 8GB)   | → |  AH81-04244A   |  classic (80GB)             | → |  AH81-04241A |
|  classic (160GB)     | → |  AH81-04242A   |  nano (video)<br>(4GB, 8GB) | → |  AH81-04243A |
|  touch (8GB, 16GB) | → |  AH81-04245A |  |   |   |

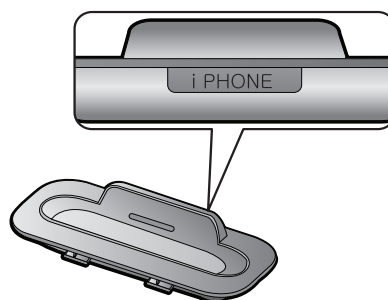
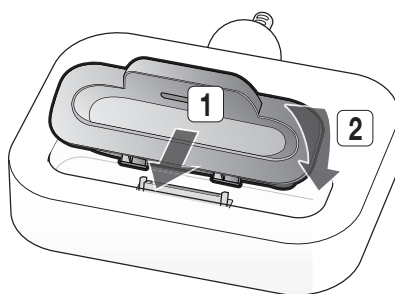

- The provided dock insert includes 5 different types. Check the dock insert for the iPod model name on its rear side before use. (The dock insert for Classic 160 GB has the model name on the bottom.)

# connections

---

## CONNECTING AUDIO FROM EXTERNAL COMPONENTS

---

### AUX1 : Connecting an External Component/MP3 player

---

Components such as an MP3 Player.

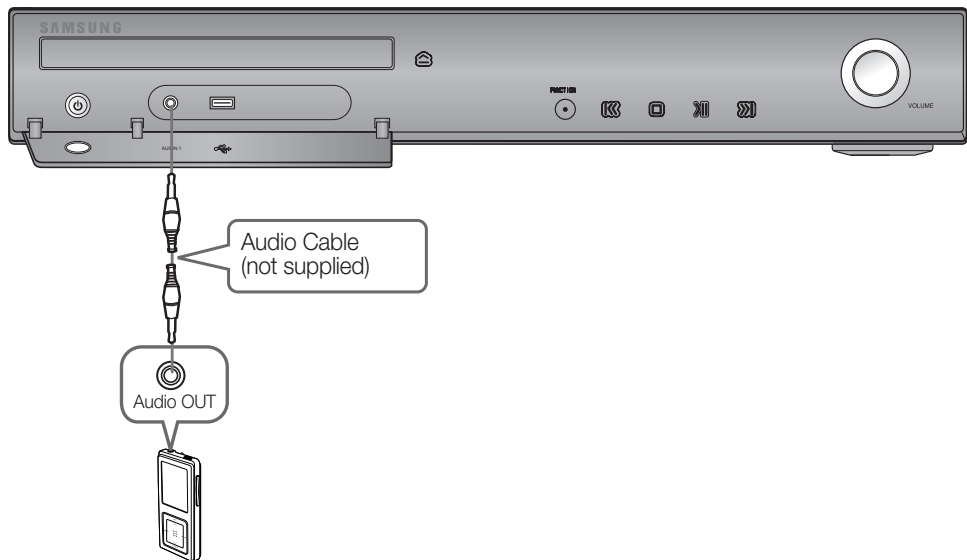

1. Connect AUX IN 1 (Audio) on the Home Theater to the Audio Out of the external component/MP3 player.
2. Press the **AUX** button on the remote control to select **AUX1** input.
  - You can also use the **FUNCTION** button on the main unit.  
The mode switches as follows :  
**DVD/CD → D.IN → AUX 1 → AUX 2 → USB → OSD iPOD → FM.**



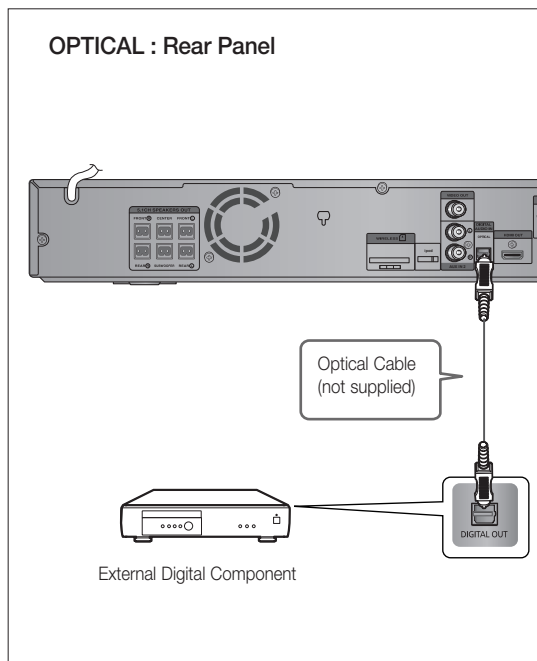
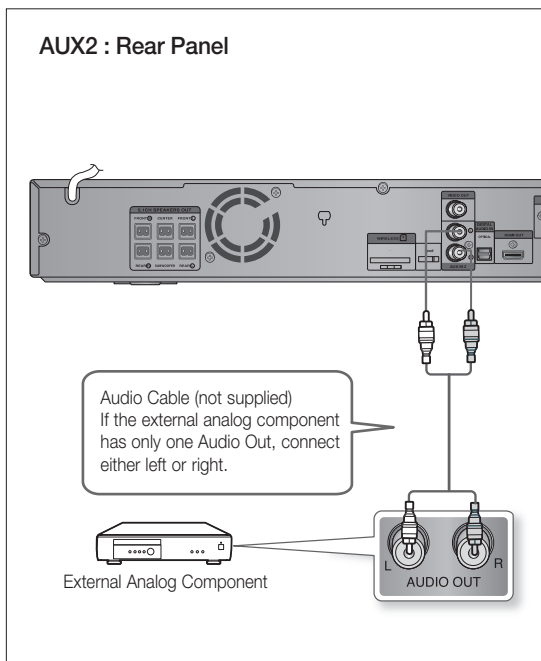

## AUX2 : Connecting an External Analog Component

Analog signal components such as a VCR.

1. Connect AUX IN 2 (Audio) on the Home Theater to the Audio Out of the external analog component.
  - Be sure to match connector colors.
2. Press the **AUX** button on the remote control to select **AUX 2** input.
  - You can also use the **FUNCTION** button on the main unit.  
The mode switches as follows :  
**DVD/CD → D.IN → AUX 1 → AUX 2 → USB → OSD iPOD → FM.**



- You can connect the Video Output jack of your VCR to the TV, and connect the Audio Output jacks of the VCR to this product.

## OPTICAL : Connecting an External Digital Component

Digital signal components such as a Cable Box/Satellite receiver (Set-Top Box).

1. Connect the Digital Input (OPTICAL) on the Home Theater to the Digital Output of the external digital component.
2. Press the **AUX** button on the remote control to select **DIGITAL IN**.
  - You can also use the **FUNCTION** button on the main unit.  
The mode switches as follows :  
**DVD/CD → D.IN → AUX 1 → AUX 2 → USB → OSD iPOD → FM.**

# connections

---

## CONNECTING THE FM ANTENNA

---

1. Connect the FM antenna supplied to the FM 75Ω COAXIAL Jack.
2. Slowly move the antenna wire around until you find a location where reception is good, then fasten it to a wall or other rigid surface.

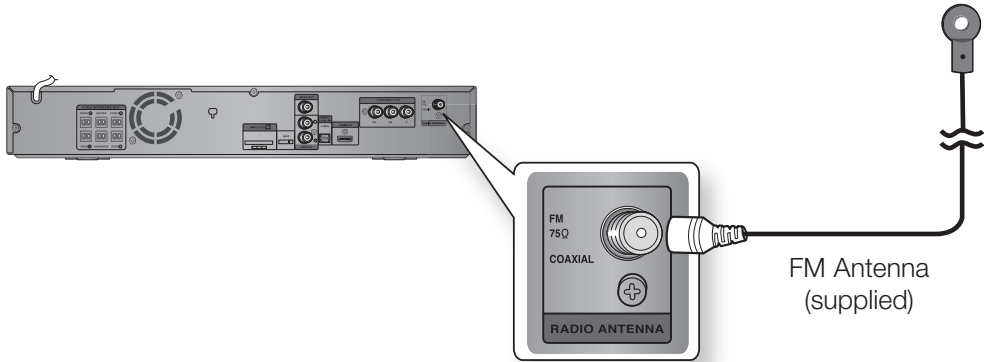

- 
-  ■ This unit does not receive AM broadcasts.

## Cooling Fan

---

The cooling fan supplies cool air to the unit to prevent overheating. Please observe the following cautions for your safety.

- Make sure the unit is well-ventilated. If the unit has poor ventilation, the temperature inside the unit may rise and may damage it.
- Do not obstruct the cooling fan or ventilation holes. (If the cooling fan or ventilation holes are covered with a newspaper or cloth, heat may build up inside the unit and fire may result.)

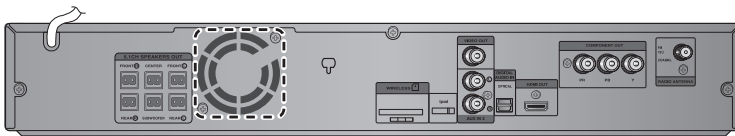

# before using your home theater

The DVD Home Theater's remote can be used to control Samsung TVs.

1. Plug the main unit's power cord into the AC power supply.



2. Press the **DVD RECEIVER** button to operate the DVD Home Theater.
3. Press the **FUNCTION** button on the main unit or **DVD** button on the remote to enable DVD/CD playback.
4. Press the **TV** button to set the remote to TV mode.
5. Press the **POWER** button to turn on your Samsung TV with this remote.
6. Press the **TV/VIDEO** button to select VIDEO mode on your TV.

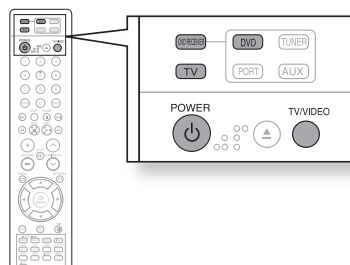

## DISC PLAYBACK

---



1. Press the **OPEN/CLOSE** (⏏) button to open the disc tray.
2. Load a disc.
  - Place a disc gently into the tray with the disc's label facing up.
3. Close the compartment by pressing the **OPEN/CLOSE** (⏏) button again.
  - Playback starts automatically.

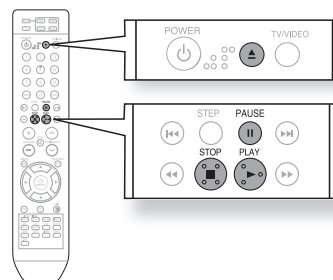

### To stop playback, press the **STOP** (⏏) button during playback.

- If pressed once, **PRESS PLAY** is displayed and the stop position will be stored in memory. If the **PLAY** (⏏) button or **ENTER** button is pressed, playback resumes from the stop position. (This function works only with DVDs.)
- If pressed twice, **STOP** is displayed, and if the **PLAY** (⏏) button is pressed, playback starts from the beginning.

### To temporarily pause playback, press the **PAUSE** (⏏) button during playback.

- To resume playback, press the **PLAY** (⏏) button.



- Depending on the content of the disc, the initial screen may appear different.
- Pirated discs will not run in this player because it violates the CSS (Content Scrambling System : a copy protection system) recommendations.

## MP3/WMA-CD PLAYBACK

Data CDs (CD-R, CD-RW) encoded in MP3/WMA format can be played.



- Place the MP3/WMA disc on the disc tray.
  - The MP3/WMA menu screen will appear and playback will start.
  - The appearance of the menu depends on the MP3/WMA disc.
  - WMA-DRM files cannot be played.
- In Stop mode, use the Cursor **▲, ▼, ◀, ▶** button to select the album, and then press the **ENTER** button.
  - Use the Cursor **▲, ▼** button to select the track.
- To change the album, use the Cursor **▲, ▼, ◀, ▶** button to select another album in Stop mode, and then press the **ENTER** button.
- Press the **STOP** (■) button to stop playback.

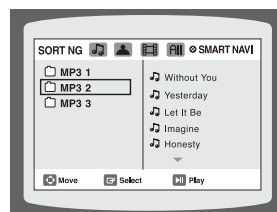
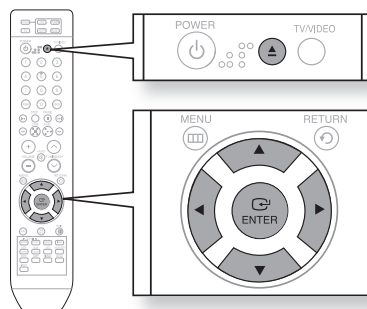

- Depending on the recording mode, some MP3/WMA-CDs may not play.
- Table of contents of a MP3-CD varies depending on the MP3/WMA track format recorded on the disc.

### To play a file icon in the screen,

- Press the Cursor **▲, ▼, ◀, ▶** button when it is in Stop mode and select a desired icon from the top part of the menu.

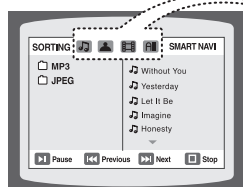

**Music File Icon** : To play music files only, select the icon.



**Image File Icon** : To view image files only, select the icon.



**Movie File Icon** : To view movie files only, select the icon.



**All File Icon** : To view all files select the icon.

# playback

## JPEG FILE PLAYBACK

Images captured with a digital camera or camcorder, or JPEG files on a PC can be stored on a CD and then played back with this Home Theater.

### Slide Mode



Place the JPEG disc on the disc tray.

- Playback starts automatically. Each image is displayed for 5 seconds and then the next image is displayed.

Press the **◀◀, ▶▶** button to skip to the next slide.

- Each time the button is pressed, the slide moves backward or forward.

### Rotate/Flip Function



Press the Cursor **▲, ▼, ◀, ▶** button during playback.

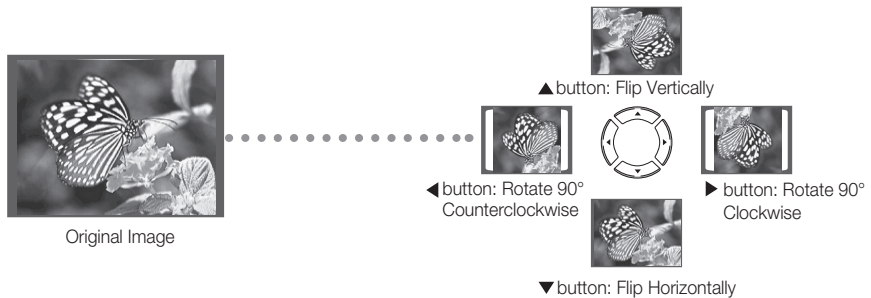
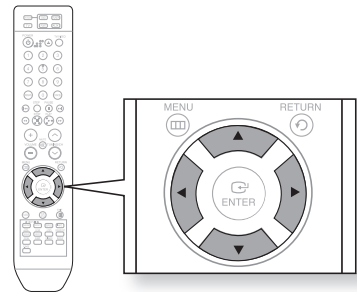

- The maximum resolutions supported by this product are 5120 x 3480 (or 19.0 MPixel) for standard JPEG files and 2048 x 1536 (or 3.0 MPixel) for progressive image files.
- If a JPEG file is played when the HDMI output resolution is 720p/1080i/1080p, the mode is automatically converted to 480p mode.

## DIVX PLAYBACK

The functions on this page apply to DivX disc playback.

### Skip Forward/Back

During playback, press the **◀▶** button.

- Goes to the next file whenever you press the **▶▶** button, if there are over 2 files in the disc.
- Goes to the previous file whenever you press the **◀◀** button, if there are over 2 files in the disc.

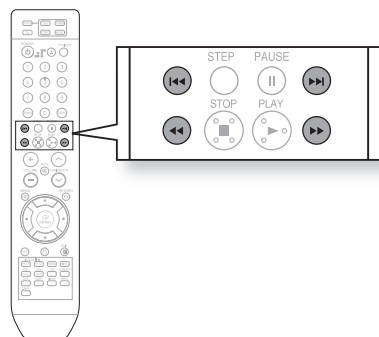

### Fast Playback

During playback, press the **◀▶** button.

To play back the disc at a faster speed, press the **◀◀** or **▶▶** button during playback.

- Each time you press either button, the playback speed will change as follows:  
**2x → 4x → 8x → 32x → Normal.**

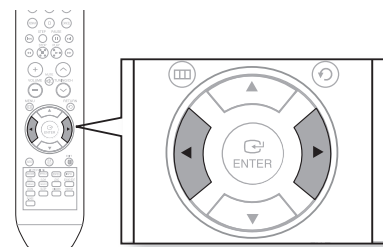

### 5 Minute Skip function

During playback, press the Cursor **◀,▶** button.

- Playback skips 5 minutes forward whenever you press the Cursor **▶** button.
- Playback skips 5 minutes back whenever you press the Cursor **◀** button.

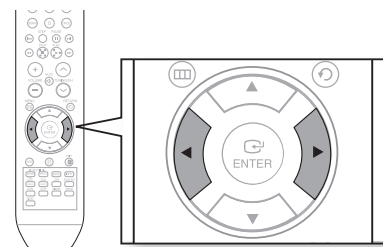

### Audio Display

Press the **AUDIO** button.

- If there are multiple audio languages on a disc, you can toggle between them.
- Each time you press the button, your selection will toggle between **AUDIO (1/N, 2/N ...)** and .

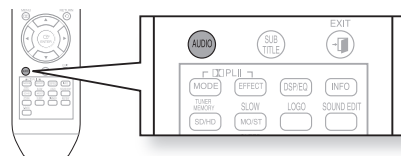

▪ is displayed when there is one supported language in the disc.

### Subtitle Display

Press the **SUBTITLE** button.

- Each time you press the button, your selection will toggle between **SUBTITLE (1/N, 2/N ...)** and **SUBTITLE OFF**.
- If the disc has only one subtitle file, it will be played automatically.
- See number 2 (Caption Function) on the next page for more details concerning Subtitle usage with DivX discs.

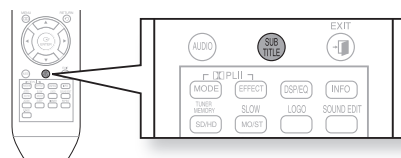

## DIVX PLAYBACK



### If the Disc has more than One Subtitle File

If the disc has more than one subtitle file, the default subtitle may not match the movie and you will have to select your subtitle language as follows:

1. In Stop mode, press the Cursor ▲,▼ button, select the desired subtitle (⏏) from the TV screen, and then press the **ENTER** button.
2. When you select the desired DivX file from the TV screen, the movie will be played normally.

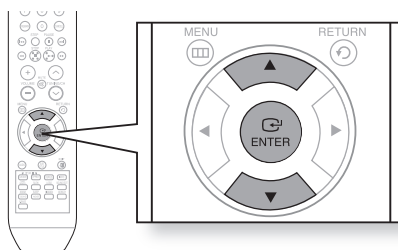

### DivX(Digital internet video eXpress)

DivX is a video file format developed by Microsoft and is based on MPEG4 compression technology to provide audio and video data over the Internet in real-time.

MPEG4 is used for video encoding and MP3 for audio encoding so that the users can watch a movie at near DVD-quality video and audio.

#### 1. Supported Formats

This product only supports the following media formats. If both video and audio formats are not supported, you may experience problems such as broken images or no sound.

##### Supported Video Formats

| Format             | AVI                    | WMV         |
|--------------------|------------------------|-------------|
| Supported Versions | DivX3.11~DivX5.1, XviD | V1/V2/V3/V7 |

##### Supported Audio Formats

| Format             | MP3        | WMA        | AC3         | DTS     |
|--------------------|------------|------------|-------------|---------|
| Bit Rate           | 80~384kbps | 56~128kbps | 128~384kbps | 1.5Mbps |
| Sampling Frequency | 44.1khz    |            | 44.1/48khz  | 44.1khz |

- DivX files, including audio and video files, created in the DTS format can only support up to 6Mbps.
- Aspect Ratio : Although the default DivX resolution is 640x480 pixels (4:3), this product supports up to 800x600 pixels (16:9). TV screen resolutions higher than 800 will not be supported.
- When you play a disc whose sampling frequency is higher than 48khz or 320kbps, you may experience shaking on the screen during playback.

#### 2. Caption Function

- You must have some experience with video extraction and editing in order to use this feature properly.
- To use the caption function, save the caption file (\*.smi) in the same file name as that of the DivX media file (\*.avi) within the same folder.  
Example. Root Samsung\_007CD1.avi  
Samsung\_007CD1.smi
- Up to 60 alphanumeric characters or 30 East Asian characters (2 byte characters such as Korean and Chinese) for the file name.



# USING THE PLAYBACK FUNCTION

## Displaying Disc Information



You can view disc playback information on the TV screen.

Press the **INFO** button.



- Depending on the disc, the disc information display may appear different.
- Depending on the disc, you can also select DTS, DOLBY DIGITAL, or PRO LOGIC.

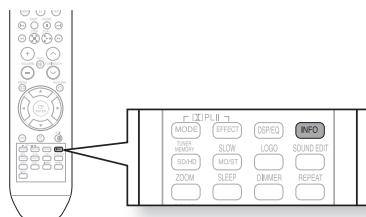

**appears on the TV screen!**

If this symbol appears on the TV screen when pressing a button, that operation is not possible with the disc currently being played.

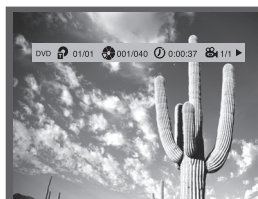

## Screen Display

|                   |                      |                         |                       |
|-------------------|----------------------|-------------------------|-----------------------|
| DVD display       | TITLE display        | ELAPSED TIME display    | STEREO (L/R) display  |
| DVD-AUDIO display | CHAPTER display      | REPEAT PLAYBACK display | DOLBY DIGITAL display |
| CD display        | TRACK (FILE) display | AUDIO LANGUAGE display  | ANGLE display         |
|                   | GROUP display        | SUBTITLE display        |                       |

## Checking the Remaining Time



Press the **REMAIN** button.

- For checking the total and remaining time of a title or chapter being played.

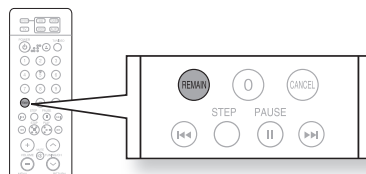

Each time the Remain button is pressed

- TITLE ELAPSED → TITLE REMAIN → CHAPTER ELAPSED → CHAPTER REMAIN**
- GROUP ELAPSED → GROUP REMAIN → TRACK ELAPSED → TRACK REMAIN**
- TRACK ELAPSED → TRACK REMAIN → TOTAL ELAPSED → TOTAL REMAIN**
- TRACK REMAIN → TRACK ELAPSED**

# playback

## USING THE PLAYBACK FUNCTION

### Fast Playback



Press the **◀▶** button.

- Each time the button is pressed during playback, the playback speed changes as follows:

◀▶ 2X → ◀▶ 4X → ◀▶ 8X → ◀▶ 32X → ▶▶ PLAY

▶▶ 2X → ▶▶ 4X → ▶▶ 8X → ▶▶ 32X → ▶▶ PLAY

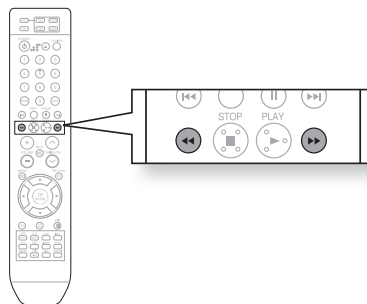

- ✍ During fast playback of a CD or MP3-CD, sound is heard only at 2x speed, and not at 4x, 8x, and 32x speeds.

### Slow Playback



Press the **SLOW** button.

- Each time the button is pressed during playback, the playback speed changes as follows:

DVD ▶▶ 1/2 → ▶▶ 1/4 → ▶▶ 1/8 → ◀▶ 1/2 → ◀▶ 1/4 → ◀▶ 1/8 → ▶▶ PLAY

DivX ▶▶ 1/2 → ▶▶ 1/4 → ▶▶ 1/8 → ▶▶ PLAY

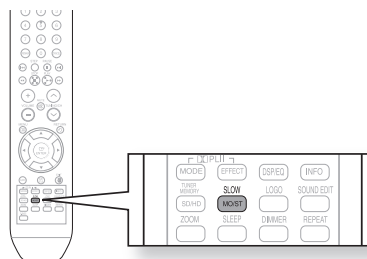

- ✍ No sound is heard during slow playback.
- Reverse slow playback does not work with CD.

### Skipping Scenes/Songs



Press the **◀▶** button.

- Each time the button is pressed during playback, the previous or next chapter, track or directory (file) will be played.
- You cannot skip chapters consecutively.

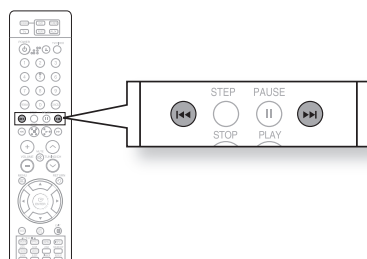

## Repeat Playback



Repeat playback allows you to repeatedly play a chapter, title, track (song), or directory (MP3 file).

Press the **REPEAT** button.

- Each time the button is pressed during playback, the repeat playback mode changes as follows:

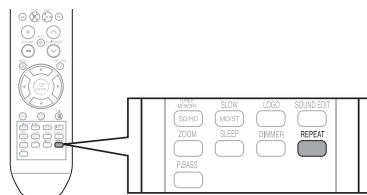

**REPEAT : CHAPTER** → **REPEAT : TITLE** → **REPEAT : OFF**



**REPEAT : TRACK** → **REPEAT : GROUP** → **REPEAT : OFF**



**REPEAT : TRACK** → **REPEAT : DISC** → **REPEAT : OFF**



**REPEAT : RANDOM** → **REPEAT : TRACK** → **REPEAT : DIR** → **REPEAT : DISC**  
→ **REPEAT : OFF**

### Repeat Playback Options

**CHAPTER** : Repeatedly plays the selected chapter.

**TITLE** : Repeatedly plays the selected title.

**GROUP** : Repeatedly plays the selected group.

**RANDOM** : Plays tracks in random order. (A track that has already been played may be played again.)

**TRACK** : Repeatedly plays the selected track.

**DIR** : Repeatedly plays all tracks in the selected folder.

**DISC** : Repeatedly plays the entire disc.

**OFF** : Cancels Repeat Playback.

### To Select a Repeat Playback Mode in the Disc Information Screen



- Press the **INFO** button twice.
- Press the Cursor **▶** button to move to REPEAT PLAYBACK (↻) display.
- Press the Cursor **▼** button to select the desired Repeat Playback mode.
  - To select another album and track, repeat Steps 2 and 3 above.
- Press the **ENTER** button.

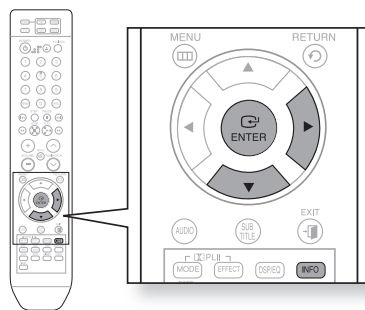

**OFF** → **A-** → **CHAP** → **TITLE** → **OFF**



**OFF** → **A-** → **TRACK** → **DISC** → **OFF**



- For DivX, MP3 and JPEG discs, you cannot select Repeat Play from the information display screen.

# playback

## USING THE PLAYBACK FUNCTION

### A-B Repeat Playback



You can repeatedly play back a designated section of a DVD.

1. Press the **INFO** button twice.
2. Press the Cursor **▶** button to move to REPEAT PLAYBACK (↻) display.
3. Press the Cursor **▲, ▼** button to select **A-** and then press the **ENTER** button.
  - When the **ENTER** button is pressed, the selected position will be stored in memory.
4. Press the **ENTER** button at the end of the desired segment.
  - The specified segment will be played repeatedly.

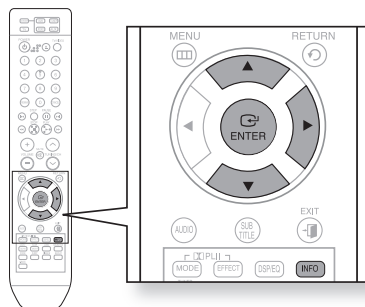

DVD ◀ EN 1/3 OFF/ 02 ↻ A - B  
A TO B REPEAT ON

➤ To return to normal playback, press the Cursor **▲, ▼** button to select **↻ OFF**.

■ The A-B Repeat function does not operate with DivX, MP3 or JPEG discs.

### Step Function



Press the **STEP** button.

- The picture moves forward one frame each time the button is pressed during playback.

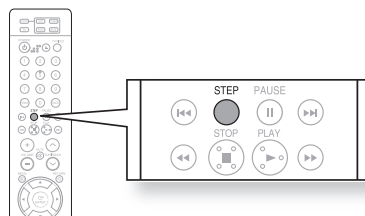

■ No sound is heard during step motion playback.

## Angle Function



This function allows you to view the same scene in different angles.

1. Press the **INFO** button.
2. Press the Cursor **▶** button to move to ANGLE ( ) display.
3. Press the Cursor **▲, ▼** button or numeric buttons to select the desired angle.
  - Each time the button is pressed, the angle changes as follows:

1/3 → 2/3 → 3/3 → 1/3

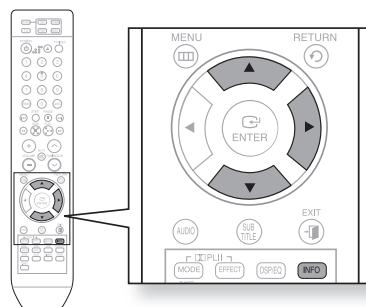

- The Angle function works only with discs on which multiple angles have been recorded.

## Zoom (Screen Enlarge) Function



This function allows you to enlarge a particular area of the displayed image.

1. Press the **ZOOM** button.
2. Press the Cursor **▲, ▼, ◀, ▶** button to move to the area you want to enlarge.
3. Press the **ENTER** button.
  - Each time the button is pressed, the zoom level changes as follows:

**ZOOM X 1.5** → **ZOOM X 2** → **ZOOM X 3**  
→ **ZOOM OFF**

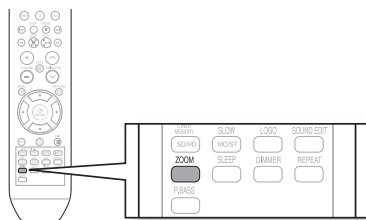

## USING THE PLAYBACK FUNCTION

---

### Bonus Group



Some DVD-Audio discs have an extra 'bonus' group that requires a 4-digit key number to access. See the disc packaging for details and the key number.

When you play a DVD-Audio disc that has a bonus group, the key number input screen appears automatically.

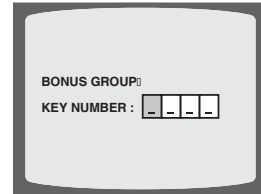

- If you eject the disc, switch the power off, or unplug the player, you will need to re-enter the key number.

### Navigating Pages



During playback, press the **∇**, **▲** button on the remote control.

- You can select the desired image from a DVD-Audio disc containing still images.
- With some discs, you may not be able to select images.

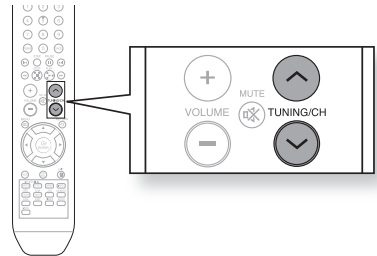

## Audio Language Selection Function



1. Press the **INFO** button twice.
2. Press the Cursor **▲, ▼** button or numeric buttons to select the desired audio language.
  - Depending on the number of languages on a DVD disc, a different audio language (ENGLISH, SPANISH, FRENCH, etc.) is selected each time the button is pressed.

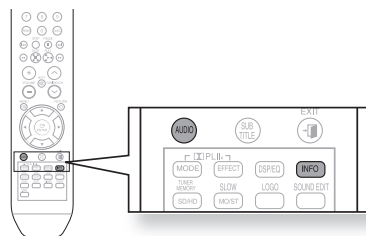

EN 1/3 → SP 2/3 → FR 3/3 → EN 1/3

## Subtitle Language Selection Function



1. Press the **INFO** button twice.
2. Press the Cursor **▶** button to move to **SUBTITLE** (📄) display.
3. Press the Cursor **▼** button or numeric buttons to select the desired subtitle.

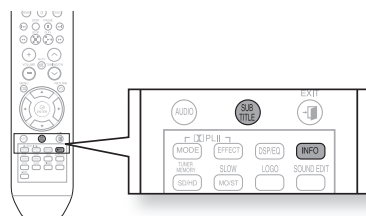

EN 01/03 → SP 02/03 → FR 03/03 → OFF/03 →

EN 01/03



- To operate this function, you can also press the **AUDIO** or **SUBTITLE** buttons on the remote control.
- Depending on the disc, the Subtitle and Audio Language functions may not be available.

## Moving Directly to a Scene/Song



1. Press the **INFO** button.
2. Press the Cursor **▲, ▼** button or numeric buttons to select the desired title/track (📄) and then press the **ENTER** button.
3. Press the Cursor **◀, ▶** button to move to the Chapter (📄) display.
4. Press the Cursor **▲, ▼** button or numeric buttons to select the desired chapter and then press the **ENTER** button.
5. Press the Cursor **◀, ▶** button to move to time (🕒) display.
6. Press the numeric buttons to select the desired time and then press the **ENTER** button.

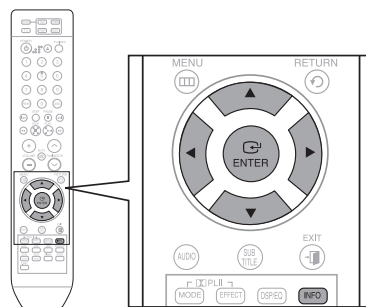

# playback

## USING THE PLAYBACK FUNCTION

### Moving Directly to a Scene/Song



Press the **numeric** buttons.

- The selected file will be played.
- When playing an MP3 or JPEG disc, you cannot use the Cursor **▲**, **▼** button to move to a folder.  
To move a folder, press the **STOP** (**■**) and then press the Cursor **▲**, **▼** button.

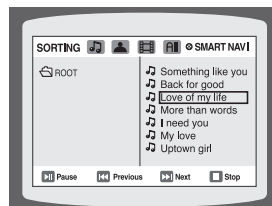

- You can press the **◀◀**, **▶▶** button on the remote control to move directly to the desired title, chapter, or track.
- Depending on the disc, you may not be able to move to the selected title or time.

### Using the Disc Menu



You can use the menus for the audio language, subtitle language, profile, etc.

DVD menu contents differ from disc to disc.

1. In Stop mode, press the **MENU** button.
2. Press the Cursor **▲**, **▼** button or numeric buttons to move to **Disc Menu** and then press the **ENTER** button.
  - When you select Disc Menu and it is not supported by the disc, the "**This menu is not supported**" message appears on the screen.
3. Press the Cursor **▲**, **▼**, **◀**, **▶** button to select the desired item.
4. Press the **ENTER** button.

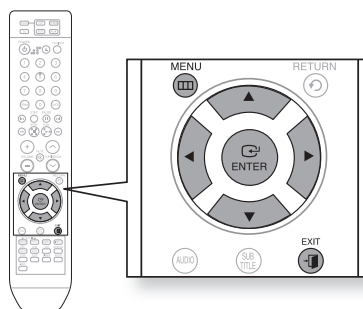

➤ Press the **EXIT** button to exit the setup screen.



- The disc menu display may be different depending on the disc.





## Using the Title Menu

For DVDs containing multiple titles, you can view the title of each movie. Depending on the disc, the availability of this feature may vary.

1. In Stop mode, press the **MENU** button.
2. Press the Cursor **▲**, **▼** button to move to **Title Menu**.
3. Press the **ENTER** button.
  - The title menu appears.

➤ Press the **EXIT** button to exit the setup screen.

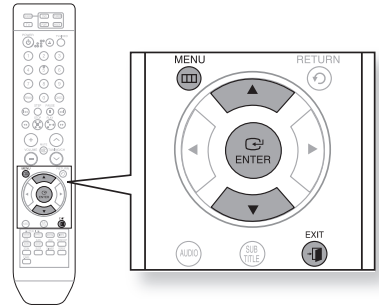

- The Title menu display may be different depending on the disc.

# playback

## USING THE iPod

You can enjoy playback of your iPod using the supplied remote control.

1. Place the iPod in the Dock.
  - Your iPod is automatically turned on.
2. Connect the dock connector for iPod to the iPod jack on the DVD home theater.
3. Press the **PORT** button on the remote control to select iPod mode.
  - Each time the button is pressed, your selection will toggle between iPod mode and USB mode.
4. Use **▲**, **▼**, **◀**, **▶** and **ENTER** button on the remote control to display the list of menu.
5. You can use the remote control or main unit to control simple playback functions such as **PLAY**, **PAUSE**, **STOP**, **NEXT/PREV**, and **FF/REW**, and **REPEAT**.

➤ Press the **RETURN** button to return to the previous menu.

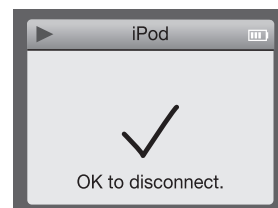

## Listening by Category

1. Press the **▲**, **▼** buttons on the remote control to **select music** and press the **ENTER** button.
  - The **Music** categories appear.
2. Press the **▲**, **▼** buttons desired category and press the **ENTER** button.
  - The music files appear.
3. Press the **▲**, **▼** buttons to select the file to play and press the **ENTER** button.
  - The music will start with a new screen which shows the song title, time, artist, and progress bar.



- Not all iPods are compatible with this unit.
- This product may not work properly, depending on the software version of iPod. Please download and install the latest software version.
- This product does not support playing photos and movies from your iPod.

## Music categories

File information including the artist name, album name, music title and genre will be displayed according to the ID3 Tag information on the appropriate music file.

**Now Playing** : Plays a recently played file or moves to the playback screen of the current file.

**Artists** : To play by artist.

**Songs** : To play in numeric or alphabetical order

**Playlists** : To play by Playlist.

**Albums** : To play by album.

**Genres** : To play by genre.

**Composer** : To play by composer.

- **What is an ID3 Tag?**  
This is what is attached to an MP3 to carry information relevant to the file such as the title, artist, album, year, genre and a comment field.

## PLAYING MEDIA FILES USING THE USB HOST FEATURE

You can enjoy media files such as pictures, movies and music saved on an MP3 player (except iPod), USB memory stick or digital camera in high quality video with 5.1 channel Home Theater sound by connecting the storage device to the USB port of the Home Theater.

1. Connect the USB device to the USB port on the front of the unit.
2. Press the **FUNCTION** button on the DVD Player or the **PORT** button on the remote control to select the USB mode.
  - **USB** appears on the display screen and then disappears.
  - The **USB MENU** screen appears on the TV screen and the saved file is played.
3. To stop playback, press the **STOP** (■) button.

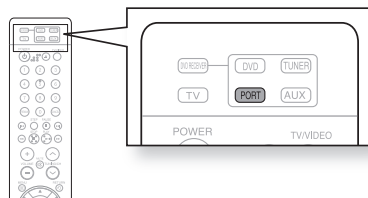
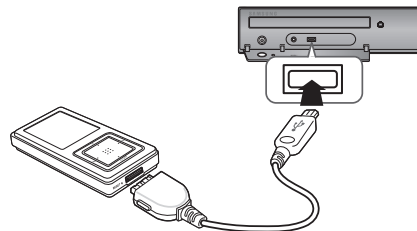

### Safe PORT Removal

To prevent damage to the memory stored in the USB device, perform safe removal before disconnecting the USB cable.

- Press the **STOP** (■) button twice in a row. The display will show **REMOVE USB**.
- Remove the USB cable.

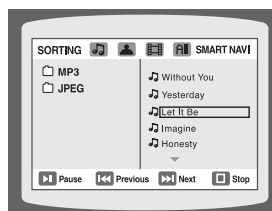

- To listen to your music files with 5.1 channel home theater sound, you must set the Dolby Pro Logic II mode to Matrix. (See page 60)
- In USB mode, you are not enabled to change the resolution or use the SETUP menu if there is no USB device connected to the USB port.

### Skip Forward/Back

During playback, press the **⏮, ⏭** button.

- When there is more than one file and you press the **⏭** button, the next file is selected.
- When there is more than one file and you press the **⏮** button, the previous file is selected.

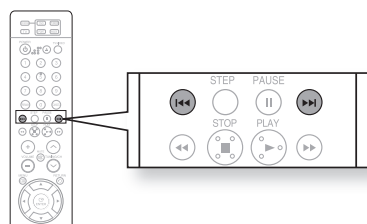

# playback

## Fast playback

During playback, press the ◀▶ button.

- Each time you press either button, the playback speed will change as follows:

2x → 4x → 8x → 32x → Normal.

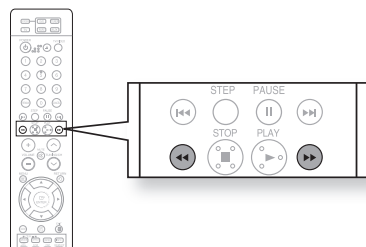

## Compatible Devices

1. USB devices that support USB Mass Storage v1.0. (USB devices that operate as a removable disc in Windows (2000 or later) without additional driver installation.)
2. MP3 Player: HDD and flash type MP3 players.
3. Digital camera: Cameras that support USB Mass Storage v1.0.
  - Cameras that operate as a removable disc in Windows (2000 or later) without additional driver installation.
4. USB HDD and USB Flash Drive: Devices that support USB2.0 or USB1.1.
  - You may experience a difference in playback quality when you connect a USB1.1 device.
  - For a USB HDD, make sure to connect an auxiliary power cord to the USB HDD for proper operation.
5. USB card Reader: One slot USB card reader and Multi slot USB card reader.
  - Depending on the manufacturer, the USB card reader may not be supported.
  - If you install multiple memory devices into a multi card reader, you may experience problems.
6. If you use a USB extension cable, the USB device might not be recognized.

## Supported Formats

| Format        | File name | File extension | Bit rate   | Version                    | Pixel   | Sampling Frequency |
|---------------|-----------|----------------|------------|----------------------------|---------|--------------------|
| Still Picture | JPG       | JPG .JPEG      | –          | –                          | 640x480 | –                  |
| Music         | MP3       | .MP3           | 80~384kbps | –                          | –       | 44.1kHz            |
|               | WMA       | .WMA           | 56~128kbps | V8                         | –       | 44.1kHz            |
| Movie         | WMV       | .WMV           | 4Mbps      | V1,V2,V3,V7                | 720x480 | 44.1kHz~48kHz      |
|               | DivX      | .AVI,.ASF      | 4Mbps      | DivX3.11~<br>DivX5.1, XviD | 720x480 | 44.1kHz~48kHz      |

- CBI (Control/Bulk/Interrupt) is not supported.
- Digital Cameras that use PTP protocol or require additional program installation when connected to a PC are not supported.
- A device using NTFS file system is not supported. (The system supports only the FAT file system and will not play a movie in larger than 1 GB in USB mode.)
- Some MP3 players, when connected to this product, may not operate depending on the sector size of their file system.
- The USB host function is not supported if a product that transfers media files by its manufacturer-specific program is connected.
- Does not operate with Janus enabled MTP (Media Transfer Protocol) devices.
- **The USB host function of this product does not support all USB devices. For information on supported devices, see page 66.**

# system setup

For your convenience, you can set this DVD Home Theater's features for the best use in your home environment.

## SETTING THE LANGUAGE

OSD(On-Screen Display) language is set to English by default.

1. In Stop mode, press the **MENU** button.
2. Press the Cursor **▼** button to move to **Setup** and then press the **ENTER** button.
3. Select **Language** and then press the **ENTER** button.
4. Press the Cursor **▲,▼** button to select **OSD Language** and then press the **ENTER** button.
5. Press the Cursor **▲,▼** button to select the desired language and then press the **ENTER** button.
  - Once the setup is complete, the OSD will be English if English has been selected as language.

- Press the **RETURN** button to return to the previous level.
- Press the **EXIT** button to exit the setup screen.

- **OSD LANGUAGE** : Selecting the OSD Language
- **AUDIO** : Selecting the Audio Language (recorded on the disc)
- **SUBTITLE** : Selecting the Subtitle Language (recorded on the disc)
- **DISC MENU** : Selecting the Disc Menu Language (recorded on the disc)
- ※ If the language you selected is not recorded on the disc, menu language will not change even if you set it to your desired language.

- **OTHERS** : To select another language, select OTHERS and enter the language code of your country. AUDIO, SUBTITLE and DISC MENU languages can be selected.



# system setup

## SETTING TV SCREEN TYPE

Depending on your TV type (Widescreen or conventional 4:3), you can select the TV's aspect ratio.

1. In Stop mode, press the **MENU** button.
  2. Press the Cursor **▼** button to move to **Setup** and then press the **ENTER** button.
  3. Press the Cursor **▼** button to move to **TV DISPLAY** and then press the **ENTER** button.
  4. Press the Cursor **▲,▼** button to select the desired item and then press the **ENTER** button.
    - Once the setup is complete, you will be taken to the previous screen.
- Press the **RETURN** button to return to the previous level.  
➤ Press the **EXIT** button to exit the setup screen.

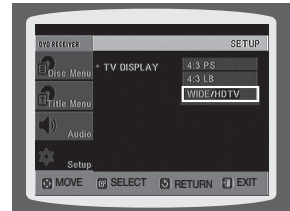
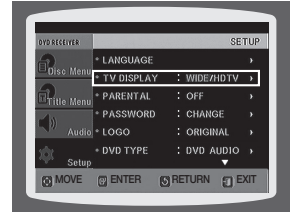

### Adjusting the TV Aspect Ratio (Screen Size)

The horizontal to vertical screen size ratio of conventional TVs is 4:3, while that of widescreen and high definition TVs is 16:9. This ratio is called the aspect ratio. When playing DVDs recorded in different screen sizes, you should adjust the aspect ratio to fit your TV or monitor.

For a standard TV, select either **4:3PS** or **4:3LB** option according to personal preference. Select **WIDE/HDTV** if you have a widescreen TV.

#### 4:3PS (4:3 Pan&Scan)

Select this to play a 16:9 picture in the pan & scan mode on a conventional TV.

- You can see the central portion of the screen only (with the sides of the 16:9 picture cut off).



#### 4:3LB (4:3 Letterbox)

Select this to play a 16:9 picture in the letter box mode on a conventional TV.

- Black bars will appear at the top and bottom of the screen.



#### WIDE/HDTV

Select this to view a 16:9 picture in the full-screen mode on your widescreen TV.

- You can enjoy the widescreen aspect.



- If a DVD is in the 4:3 ratio, you cannot view it in widescreen.
- Since DVD discs are recorded in various image formats, they will look different depending on the software, the type of TV, and the TV aspect ratio setting.
- When using HDMI, the screen is automatically converted to Wide mode.

## SETTING PARENTAL CONTROLS (RATING LEVEL)

Use this to restrict playback of adult or violent DVDs you do not want children to view.

1. In Stop mode, press the **MENU** button.
2. Press the Cursor **▼** button to move to **Setup** and then press the **ENTER** button.
3. Press the Cursor **▼** button to move to **PARENTAL** and then press the **ENTER** button.
4. Press the Cursor **▲,▼** button to select the desired rating level and then press the **ENTER** button.
  - If you have selected Level 6, you cannot view DVDs with Level 7 or higher.
  - The higher the level, the closer the content is to violent or adult material.
5. Enter the password and then press the **ENTER** button.
  - The password is set to "7890" by default.
  - Once the setup is complete, you will be taken to the previous screen.

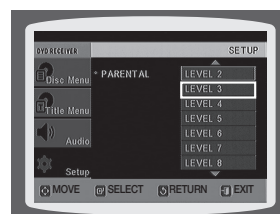
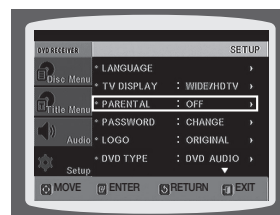

- Press the **RETURN** button to return to the previous level.
- Press the **EXIT** button to exit the setup screen.



- This function works only if a DVD disc contains the rating level information.

## SETTING THE PASSWORD

You can set the password for the Parental (rating level) setting.

1. In Stop mode, press the **MENU** button.
2. Press the Cursor **▼** button to move to **Setup** and then press the **ENTER** button.
3. Press the Cursor **▼** button to move to **PASSWORD** and then press the **ENTER** button.
4. Press the **ENTER** button.
5. Enter the password and then press the **ENTER** button.
  - Enter the old password, a new password, and confirm new password.
  - The setting is complete.

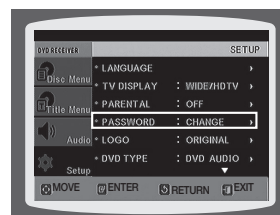

- The password is set to "7890" by default.

### If you have forgotten the rating level password, do the following

- While the player is in No Disc mode, hold the DVD Players **STOP** (■) button for longer than 5 seconds. **INITIAL** appears on the display and all settings will return to the default values.
- Press the **POWER** button.

Using the RESET function will erase all stored settings.  
Do not use this unless necessary.

# system setup

## SETTING THE WALLPAPER



While watching a DVD or JPEG CD, you can set the image you like as background wallpaper.

1. During playback, press the **PAUSE** button when an image you like appears.
2. Press the **LOGO** button.
  - **COPY LOGO DATA** will be displayed on the TV screen.
3. The power will turn off and then back on.
  - The selected wallpaper will be displayed.
  - You can select up to 3 wallpaper settings.

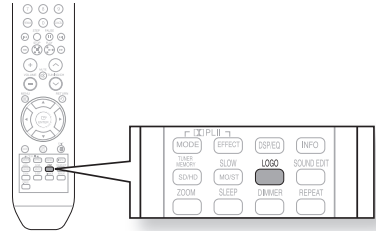

 This function will not work when the HDMI output is 720p, 1080i or 1080p.

## TO SELECT ONE OF THE 3 WALLPAPER SETTINGS YOU'VE MADE

1. In Stop mode, press the **MENU** button.
2. Press the Cursor **▼** button to move to **Setup** and then press the **ENTER** button.
3. Press the Cursor **▼** button to move to **LOGO** and then press the **ENTER** button.
4. Press the Cursor **▲, ▼** button to select the desired **USER**, and then press the **ENTER** button.
  - This selects one of the 3 wallpaper screens.
5. Press the **EXIT** button to exit the setup screen.

- **ORIGINAL** : Select this to set the Samsung Logo image as your wallpaper.
- **USER** : Select this to set the desired image as your wallpaper.

- Press the **RETURN** button to return to the previous level.
- Press the **EXIT** button to exit the setup screen.

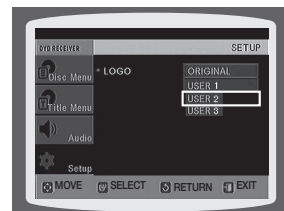



## DVD PLAYBACK MODE

Some DVD-Audio discs contain DVD-Video as well as DVD-Audio.

To play back the DVD-Video portion of the DVD-Audio disc, set the unit to DVD-Video mode.

1. Press the **MENU** button while the disc tray is open.
2. Press the Cursor **▼** button to move to **Setup** and then press the **ENTER** button.
3. Press the Cursor **▼** button to move to **DVD TYPE** and then press the **ENTER** button.
4. Press the Cursor **▲,▼** button to move to **DVD VIDEO** and then press the **ENTER** button.

- Set steps 1 ~ 4 again if you want to switch to DVD AUDIO Play mode.
- **DVD VIDEO** : Set to play the DVD video contents contained on a DVD audio disc.
- **DVD AUDIO** : Set to play the default DVD audio.



- DVD Play mode is set to DVD Audio as factory default setting.
- Powering off the main unit will automatically switch to the DVD Audio mode.

## DviX (R) Registration

Please use the Registration code to register this player with the DivX (R) video on demand format.

To learn more, go to [www.divx.com/vod](http://www.divx.com/vod).

## SETTING THE SPEAKER MODE

Signal outputs and frequency responses from the speakers will automatically be adjusted according to your speaker configuration and whether certain speakers are used or not.

1. In Stop mode, press the **MENU** button.
2. Press the Cursor **▼** button to move to **Audio** and then press the **ENTER** button.
3. In the **SPEAKER SETUP**, press the **ENTER** button again.
4. Press the Cursor **▲,▼,◀,▶** button to move to the desired speaker and then press the **ENTER** button.
  - For C, SL, and SR, each time the button is pressed, the mode switches alternately as follows : SMALL → NONE.
  - For L and R, the mode is set to SMALL.

- **SMALL** : Select this when using the speakers.
- **NONE** : Select this when no speaker is connected.

- Press the **RETURN** button to return to the previous level.
- Press the **EXIT** button to exit the setup screen.

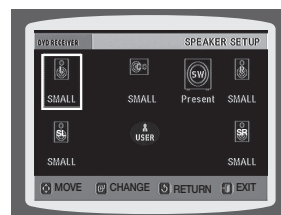

- Depending on PRO LOGIC and STEREO settings, the speaker mode may vary (see page 60).

# system setup

## SETTING THE DELAY TIME

If the speakers cannot be placed at equal distances from the listening position, you can adjust the delay time of the audio signals from the center and rear speakers.

1. In Stop mode, press the **MENU** button.
  2. Press the Cursor **▼** button to move to **Audio** and then press the **ENTER** button.
  3. Press the Cursor **▼** button to move to **DELAY TIME** and then press the **ENTER** button.
  4. Press the Cursor **▲, ▼, ◀, ▶** button to move to the desired speaker and then press the **ENTER** button.
  5. Press the Cursor **◀, ▶** to set the Delay time.
    - You can set the delay time for C between 00 and 05mSEC and for SL and SR between 00 and 15mSEC.
- Press the **RETURN** button to return to the previous level.
- Press the **EXIT** button to exit the setup screen.

### Setting up the Speaker Delay Time

When 5.1CH Surround Sound is played, you can enjoy the best sound if the distance between you and each speaker is the same.

Since the sounds arrive at the listening position at different times depending on the placement of speakers, you can adjust this difference by adding a delay effect to the sound of the Center and Rear Speakers.

#### Setting CENTER SPEAKER

If the distance of Dc is equal to or longer than the distance of Df in the figure, set the mode as 0ms. Otherwise, change the setting according to the table.

|                            |           |                     |                     |                     |                     |                     |
|----------------------------|-----------|---------------------|---------------------|---------------------|---------------------|---------------------|
| Distance between Df and Dc | 0.00 inch | 1 feet, 1.39 inches | 2 feet, 2.77 inches | 3 feet, 5.73 inches | 4 feet, 7.12 inches | 5 feet, 9.29 inches |
| Delay Time                 | 0 ms      | 1 ms                | 2 ms                | 3 ms                | 4 ms                | 5 ms                |

#### Setting REAR SPEAKER

If the distance of Dc is equal to or longer than the distance of Df in the figure, set the mode as 0ms.

Otherwise, change the setting according to the table.

|                            |           |                     |                     |                      |                       |                      |
|----------------------------|-----------|---------------------|---------------------|----------------------|-----------------------|----------------------|
| Distance between Df and Dc | 0.00 inch | 3 feet, 5.73 inches | 6 feet, 11.7 inches | 10 feet, 4.80 inches | 13 feet, 10.54 inches | 17 feet, 4.27 inches |
| Delay Time                 | 0 ms      | 3 ms                | 6 ms                | 9 ms                 | 12 ms                 | 15 ms                |

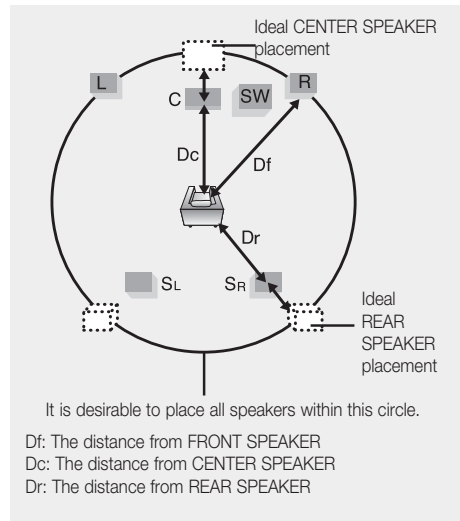

- With **PL II** (Dolby Pro Logic II), the delay time may be different for each mode.
- With AC-3 and DTS, the delay time can be set between 00 and 15mSEC.
- The Center channel is only adjustable on 5.1 channel discs.

## SETTING THE TEST TONE

Use the Test Tone feature to check the speaker connections.

1. In Stop mode, press the **MENU** button.
  2. Press the Cursor **▼** button to move to **Audio** and then press the **ENTER** button.
  3. Press the Cursor **▼** button to move to **TEST TONE** and then press the **ENTER** button.
    - The test tone will be sent to **L → C → R → SR → SL → SW** in order.  
If the **ENTER** button is pressed again at this time, the test tone will stop.
- Press the **RETURN** button to return to the previous level.
- Press the **EXIT** button to exit the setup screen.

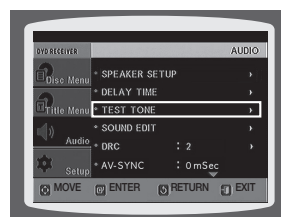

## SETTING THE AUDIO

You can adjust the balance and level for each speaker.

1. In Stop mode, press the **MENU** button.
  2. Press the Cursor **▼** button to move to **Audio** and then press the **ENTER** button.
  3. Press the Cursor **▼** button to move to **SOUND EDIT** and then press the **ENTER** button.
  4. Press the Cursor **▲, ▼** button to select and adjust the desired item. Press the Cursor **◀, ▶** button to adjust the settings.
- Press the **RETURN** button to return to the previous level.
- Press the **EXIT** button to exit the setup screen.

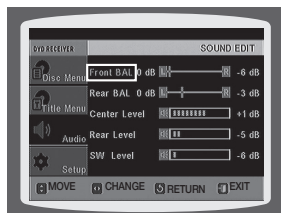
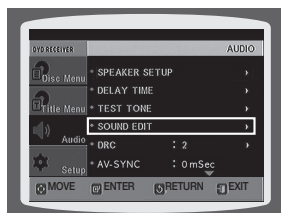

# system setup

## SETTING THE AUDIO

### Manually Adjusting the Speaker Volume and Balance with the SOUND EDIT Button.

Press the **SOUND EDIT** button and then press the Cursor **◀,▶** button.

```
.... 00 F .... 00
.... 00 R .... 00
CEN 00 dB
REAR 00 dB
SW 00 dB
```

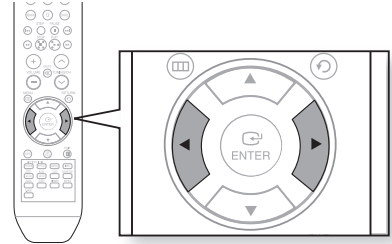

#### Adjusting Front/Rear Speaker Balance

- You can select between 00, -06, and OFF.
- The volume decreases as you move closer to -6.

#### Adjusting Center/Rear/Subwoofer Speaker Level

- The volume level can be adjusted in steps from +6dB to -6dB.
- The sound gets louder as you move closer to +6dB and quieter as you get closer to -6dB.

## SETTING THE DRC (DYNAMIC RANGE COMPRESSION)

This feature balances the range between the loudest and quietest sounds. You can use this function to enjoy Dolby Digital sound when watching movies at low volume at night.

1. In Stop mode, press the **MENU** button.
  2. Press the Cursor **▼** button to move to **Audio** and then press the **ENTER** button.
  3. Press the Cursor **▼** button to move to **DRC** and then press the **ENTER** button.
  4. Press the Cursor **▲,▼** to adjust the **DRC**.
    - When the Cursor **▲** button is pressed, the effect is greater, and when the Cursor **▼** button is pressed, the effect is smaller.
- Press the **RETURN** button to return to the previous level.
- Press the **EXIT** button to exit the setup screen.

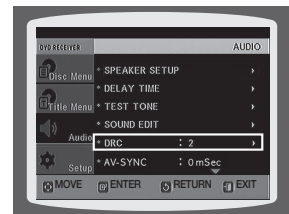

## SETTING THE AV SYNC

Video may look slower than the audio if it is connected to a digital TV. If this occurs, adjust the audio delay time to match the video.

1. In Stop mode, press the **MENU** button.
  2. Press the Cursor **▼** button to move to **Audio** and then press the **ENTER** button.
  3. Press the Cursor **▼** button to move to **AV-SYNC** and then press the **ENTER** button.
  4. Press the Cursor **▲,▼** button to select the AV-SYNC Delay Time and then press the **ENTER** button.
    - You can set the audio delay time between 0 ms and 300 ms. Set it to the optimal status.
- Press the **RETURN** button to return to the previous level.
- Press the **EXIT** button to exit the setup screen.

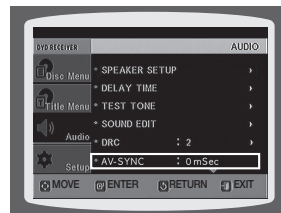

## SETTING THE HDMI AUDIO

The audio signals transmitted over the HDMI Cable can be toggled ON/OFF.

1. In Stop mode, press the **MENU** button.
  2. Press the Cursor **▼** button to move to **Audio** and then press the **ENTER** button.
  3. Press the Cursor **▼** button to move to **HDMI AUDIO** and then press the **ENTER** button.
  4. Press the Cursor **▲,▼** button to select **ON** or **OFF** and then press the **ENTER** button.
    - **ON** : Both video and audio signals are transmitted over the HDMI connection cable, and audio is output through your TV speakers only.
    - **OFF** : Video is transmitted over the HDMI connection cable only, and audio is output through the home theater speakers only.
- Press the **RETURN** button to return to the previous level.
- Press the **EXIT** button to exit the setup screen.



- The default setting of this function is HDMI AUDIO OFF.
- HDMI AUDIO is automatically down-mixed to 2ch for TV speakers.

# system setup

## SOUND FIELD (DSP)/EQ FUNCTION

DSP(Digital Signal Processor) : DSP modes have been designed to simulate different acoustic environments.  
EQ : You can select ROCK, POP, or CLASSIC to optimize the sound for the genre of music you are playing

Press the DSP/EQ button.

- **DSP** appears on the display panel.

Each time the button is pressed, the selection changes as follows:

**POPS → JAZZ → ROCK → STUDIO → CLUB → HALL → MOVIE → CHURCH → PASS**

- **POPS, JAZZ, ROCK** : Depending on the genre of music, you can select POP, JAZZ, and ROCK.
- **STUDIO** : Provides a sense of presence as if in a studio.
- **CLUB** : Simulates the sound of a dance club with a throbbing bass beat.
- **HALL** : Provides a clear vocal as if listening in a concert hall.
- **MOVIE** : Provides the feeling of a movie theater.
- **CHURCH** : Gives the feel of being in a grand church.
- **PASS** : Select this for normal listening.

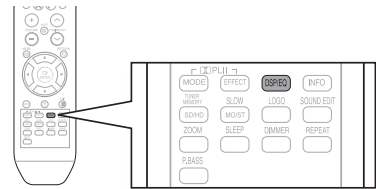

- The DSP/EQ function is only available in STEREO mode. Press the **PL II mode** button to show STEREO on the display.
- This feature works with CDs, MP3-CDs, 2 channel DVD-Audio, DivX and Dolby Digital discs.
- When playing a DVD disc encoded with two or more channels, multi-channel mode will be selected automatically and DSP/EQ function does not work.

## DOLBY PRO LOGIC II MODE

You can select the desired Dolby Pro Logic II audio mode.

Press the **PL II MODE** button.

- Each time the button is pressed, the mode changes as follows.

**MUSIC → CINEMA → PRO LOGIC → MATRIX →  
STEREO → MUSIC**

### PRO LOGIC II

- **MUSIC** : When listening to music, you can experience sound effects as if you are listening to the actual performance.
- **CINEMA** : Adds realism to the movie soundtrack.
- **PRO LOGIC** : You will experience a realistic multi-channel effect, as if using five speakers, while using just the front left and right speakers.
- **MATRIX** : You will hear 5.1 channel surround sound.
- **STEREO** : Select this to listen to sound from the front left and right speakers and the subwoofer only.

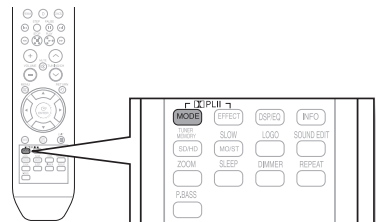

- When selecting Pro Logic II mode, connect your external device to the AUDIO INPUT jacks (L and R) on the player. If you connect to only one of the inputs (L or R), you cannot listen to surround sound.

## DOLBY PRO LOGIC II EFFECT

This function works only in Dolby Pro Logic MUSIC mode.

1. Press the **PL II MODE** button to select **MUSIC** mode.
2. Press the **PL II EFFECT** button.
  - Each time the button is pressed, the mode changes as follows.
3. Press the **◀▶** buttons to select the desired effect setting.
  - PANORAMA : You can select either 0 or 1.
  - C- WIDTH : You can select between 0 and 7.
  - DIMENS : You can select between 0 and 6.

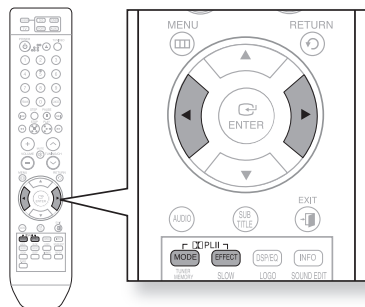

## P.BASS

P.BASS function boosts the bass for a more powerful sound.

1. Press the **P.BASS** button to select **P.BASS** mode.
2. Press the P.Bass button again to turn off the P.Bass mode.

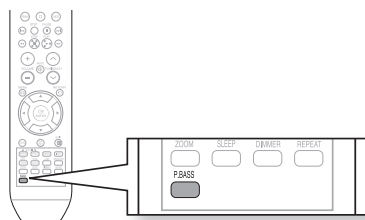

- The P.BASS function is only available with 2 channel LPCM sources such as mp3, Divx, cd and wma. Press P.BASS button and "POWER BASS ON" will be displayed on the screen.
- The P.bass does not work with DSP/EQ or DOLBY PRO LOGIC II modes. If you press P.BASS in the DSP/EQ mode, the DSP/EQ mode is automatically shut off and the P. BASS function comes on.

## LISTENING TO RADIO

### Remote Control

1. Press the **TUNER** button to select the FM band.
2. Tune in to the desired station.
  - **Automatic Tuning 1** : When the **◀◀, ▶▶** button is pressed, a preset broadcast station is selected.
  - **Automatic Tuning 2** : Press and hold the **▲, ▼** button to automatically search for active broadcasting stations.
  - **Manual Tuning** : Briefly press the **▲, ▼** button to increase or decrease the frequency incrementally.

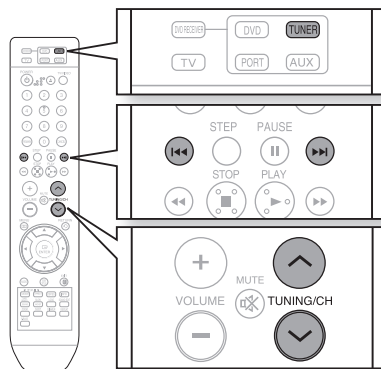

### Main Unit

1. Press the **FUNCTION** button to select the FM band.
2. Select a broadcast station.
  - **Automatic Tuning 1** : Press the **STOP** (■) button to select **PRESET** and then press the **◀◀, ▶▶** button to select the preset station.
  - **Automatic Tuning 2** : Press the **STOP** (■) button to select **MANUAL** and then press and hold the **◀◀, ▶▶** button to automatically search the band.
  - **Manual Tuning** : Press the **STOP** (■) button to select **MANUAL** and then briefly press the **◀◀, ▶▶** button to tune in to a lower or higher frequency.

Press the **MO/ST** button to listen in Mono/Stereo.

- Each time the button is pressed, the sound switches between **STEREO** and **MONO**.
- In a poor reception area, select **MONO** for a clear, interference-free broadcast.

## PRESETTING STATIONS

Example : Presetting FM 89.10 in the memory

1. Press the **TUNER** button to select the FM band.
2. Press the **▲, ▼** button to select **89.10**.
3. Press the **TUNER MEMORY** button.
4. Press the **◀◀, ▶▶** button to select preset number.
  - You can select between 1 and 15 presets.
5. Press the **TUNER MEMORY** button again.
6. To preset another station, repeat steps 2 to 5.
  - To tune in to a preset station, press the **◀◀, ▶▶** button on the remote control to select a channel.

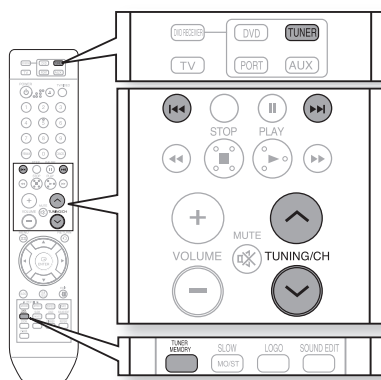



# convenient function

## SLEEP TIMER FUNCTION

You can set the time that the Home Theater will shut itself off.

Press the **SLEEP** button.

- **SLEEP** will be displayed. Each time the button is pressed, the preset time changes as follows :  
10 → 20 → 30 → 60 → 90 → 120 → 150 → OFF.

To confirm the sleep timer setting, press the **SLEEP** button.

- The remaining time before the Home Theater will shut itself off is displayed.
- Pressing the button again changes the sleep time from what you have set earlier.

To cancel the sleep timer, press the **SLEEP** button until **OFF** appears on the display.

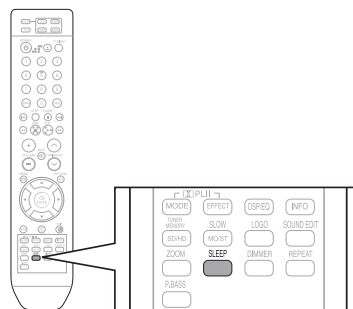

## ADJUSTING DISPLAY BRIGHTNESS

You can adjust the brightness of the display on the main unit so it won't interfere with your movie viewing.

Press the **DIMMER** button.

- Each time the button is pressed, the brightness of front display will be adjusted.

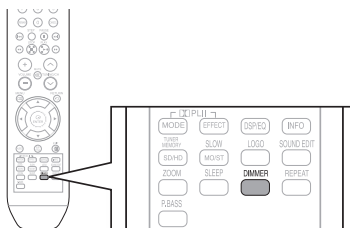

## MUTE FUNCTION

This is useful when answering a doorbell or telephone call.

Press the **MUTE** button.

- **MUTE** appears in the display.
- To restore the sound, press the **MUTE** button again.

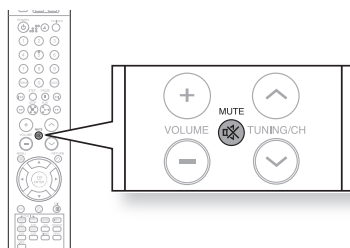

# troubleshooting

Refer to the chart below when this unit does not function properly. If the problem you are experiencing is not listed below or if the instruction below does not help, turn off the unit, disconnect the power cord, and contact the nearest authorized dealer or Samsung Electronics Service Center.

| SYMPTOM   | Check/Remedy   |
|---|--|
| <b>Disc tray does not open.</b>   | <ul style="list-style-type: none"> <li>• Is the power cord plugged securely into the outlet?</li> <li>• Turn off the power and then turn it back on.</li> </ul>  |
| <b>'Please connect your ipod' appears on the screen.</b>                          | <ul style="list-style-type: none"> <li>• Remove the iPod from the docking cradle and reinsert again.</li> <li>• If the battery level of your iPod is totally drained, you have to charge it again before use.</li> </ul>   |
| <b>Playback does not start immediately when the Play/Pause button is pressed.</b> | <ul style="list-style-type: none"> <li>• Are you using a deformed disc or a disc with scratches on the surface?</li> <li>• Wipe the disc clean.</li> </ul>   |
| <b>Sound is not produced.</b>   | <ul style="list-style-type: none"> <li>• No sound is heard during fast playback, slow playback, and step motion playback.</li> <li>• Are the speakers connected properly? Is the speaker setup correctly customized?</li> <li>• Is the disc severely damaged?</li> </ul>   |
| <b>Sound can be heard only from a few speakers and not all six.</b>               | <ul style="list-style-type: none"> <li>• When listening to a CD or radio, sound is output to the front speakers (L/R) only. Select "PRO LOGIC II" by pressing  PL II (Dolby Pro Logic II) on the remote control to use all six speakers.</li> <li>• Make sure that the DVD disc is 5.1-CH compatible.</li> <li>• If you set C, SL, and SR to NONE in the speaker mode in the audio setup of the setup screen, no sound is heard from the center speaker and the front left and right speakers. Set C, SL, and SR to SMALL.</li> </ul> |
| <b>Dolby Digital 5.1 CH Surround Sound is not produced.</b>                       | <ul style="list-style-type: none"> <li>• Is there "Dolby Digital 5.1 CH" mark on the disc? Dolby Digital 5.1 CH Surround Sound is produced only if the disc is recorded with 5.1 channel sound.</li> <li>• Is the audio language correctly set to DOLBY DIGITAL 5.1-CH in the information display?</li> </ul>  |
| <b>The remote control does not work.</b>  | <ul style="list-style-type: none"> <li>• Is the remote control being operated within its operation range of angle and distance?</li> <li>• Are the batteries exhausted?</li> <li>• Have you selected the mode(TV/DVD) functions of the remote control (TV or DVD) correctly?</li> </ul>  |

| SYMPTOM   | Check/Remedy   |
|---|--|
| <ul style="list-style-type: none"> <li>• Disc is rotating but no picture is produced.</li> <li>• Picture quality is poor and picture is shaking.</li> </ul>                                   | <ul style="list-style-type: none"> <li>• Is the TV power on?</li> <li>• Are the video cables connected properly?</li> <li>• Is the disc dirty or damaged?</li> <li>• A poorly manufactured disc may not be playable.</li> </ul>  |
| <p>Audio language and subtitles do not work.</p>  | <ul style="list-style-type: none"> <li>• Audio language and subtitles will not work if the disc does not contain them.</li> </ul>  |
| <p>Menu screen does not appear even when the menu function is selected.</p>   | <ul style="list-style-type: none"> <li>• Are you using a disc that does not contain menus?</li> </ul>  |
| <p>Aspect ratio cannot be changed.</p>  | <ul style="list-style-type: none"> <li>• You can play 16:9 DVDs in 16:9 WIDE mode, 4:3 LETTER BOX mode, or 4:3 PAN SCAN mode, but 4:3 DVDs can be seen in 4:3 ratio only. Refer to the DVD disc jacket and then select the appropriate function.</li> </ul>  |
| <ul style="list-style-type: none"> <li>• The main unit is not working. (Example: The power goes out or strange noise is heard.)</li> <li>• The DVD player is not working normally.</li> </ul> | <ul style="list-style-type: none"> <li>• Turn off the power and hold the <b>STOP</b> (■) button on the main unit for longer than 5 seconds (reset function).</li> </ul> <p><b>Using the RESET function will erase all stored settings. Do not use this unless necessary.</b></p>   |
| <p>The password for rating level has been forgotten.</p>  | <ul style="list-style-type: none"> <li>• While “NO DISC” message appears on the display of main unit, hold the main unit's <b>STOP</b> (■) button for longer than 5 seconds. “INITIAL” appears on the display and all settings will return to the default values.</li> <li>• Press the POWER button.</li> </ul> <p><b>Using the RESET function will erase all stored settings. Do not use this unless necessary.</b></p> |
| <p>Can't receive radio broadcast.</p>   | <ul style="list-style-type: none"> <li>• Is the antenna connected properly?</li> <li>• If the antenna's input signal is weak, install an external FM antenna in an area with good reception.</li> </ul>  |

# USB host feature supported products

## DIGITAL CAMERA

| Product            | Company | Type           | Product      | Company   | Type           |
|--------------------|---------|----------------|--------------|-----------|----------------|
| Finepix-A340       | Fuji    | Digital Camera | U300         | Olympus   | Digital Camera |
| Finepix-F810       | Fuji    | Digital Camera | X-350        | Olympus   | Digital Camera |
| Finepix-F610       | Fuji    | Digital Camera | C-760        | Olympus   | Digital Camera |
| Finepix-f450       | Fuji    | Digital Camera | C-5060       | Olympus   | Digital Camera |
| Finepix S7000      | Fuji    | Digital Camera | X1           | Olympus   | Digital Camera |
| Finepix A310       | Fuji    | Digital Camera | U-mini       | Olympus   | Digital Camera |
| KD-310Z            | Konica  | Digital Camera | Lumix-FZ20   | Panasonic | Digital Camera |
| Finecam SL300R     | Kyocera | Digital Camera | DMC-FX7GD    | Panasonic | Digital Camera |
| Finecam SL400R     | Kyocera | Digital Camera | Lumix LC33   | Panasonic | Digital Camera |
| Finecam S5R        | Kyocera | Digital Camera | LUMIX DMC-F1 | Panasonic | Digital Camera |
| Finecam Xt         | Kyocera | Digital Camera | Optio-S40    | Pentax    | Digital Camera |
| Dimage-Z1          | Minolta | Digital Camera | Optio-S50    | Pentax    | Digital Camera |
| Dimage Z1          | Minolta | Digital Camera | Optio 33LF   | Pentax    | Digital Camera |
| Dimage X21         | Minolta | Digital Camera | Optio MX     | Pentax    | Digital Camera |
| Coolpix4200        | Nikon   | Digital Camera | Digimax-420  | Samsung   | Digital Camera |
| Coolpix4300        | Nikon   | Digital Camera | Digimax-400  | Samsung   | Digital Camera |
| Coolpix 2200       | Nikon   | Digital Camera | Sora PDR-T30 | Toshiba   | Digital Camera |
| Coolpix 3500       | Nikon   | Digital Camera | Coolpix 5900 | Nikon     | Digital Camera |
| Coolpix 3700       | Nikon   | Digital Camera | Coolpix S1   | Nikon     | Digital Camera |
| Coolpix 4100       | Nikon   | Digital Camera | Coolpix 7600 | Nikon     | Digital Camera |
| Coolpix 5200       | Nikon   | Digital Camera | DMC-FX7      | Panasonic | Digital Camera |
| Stylus 410 digital | Olympus | Digital Camera | Dimage Xt    | Minolta   | Digital Camera |
| 300-digital        | Olympus | Digital Camera | AZ-1         | Olympus   | Digital Camera |
| 300-digital        | Olympus | Digital Camera |              |           |                |

## USB FLASH DISC

| Product          | Company  | Type                         | Product    | Company  | Type         |
|------------------|----------|------------------------------|------------|----------|--------------|
| Cruzer Micro     | Sandisk  | USB 2.0 USB Flash Drive 128M | XTICK      | LG       | USB 2.0 128M |
| Cruzer Mini      | Sandisk  | USB 2.0 128M                 | Micro Mini | lomega   | USB 2.0 128M |
| Cruzer Mini      | Sandisk  | USB 2.0 256M                 | iFlash     | Imation  | USB 2.0 64M  |
| SONY Micro Vault | Sony     | USB 2.0 64MB                 | LG         | XTICK(M) | USB 2.0 64M  |
| FLEX DRIVE       | Serotech | USB 2.0 32MB                 | RiDATA     | EZDrive  | USB 2.0 64M  |
| AnyDrive         | A.L tech | USB 2.0 128MB                |            |          |              |

## MP3 PLAYER

| Product              | Company  | Type               | Product   | Company | Type             |
|----------------------|----------|--------------------|-----------|---------|------------------|
| Creative MuVo NX128M | Creative | 128 MB MP3 Player  | YP-K3     | Samsung | MP3 Player       |
| Iriver H320          | Iriver   | 20G HDD MP3 Player | YP-U3     | Samsung | MP3 Player       |
| YH-920               | Samsung  | 20G HDD MP3 Player | YP-Z5F    | Samsung | MP3 Player       |
| YP-T7                | Samsung  | MP3 Player         | iAUDIO U2 | Cowon   | MP3 Player       |
| YP-MT6               | Samsung  | MP3 Player         | iAUDIO G3 | Cowon   | MP3 Player       |
| YP-T6                | Samsung  | MP3 Player         | iAudio M3 | Cowon   | HDD MP3 Player   |
| YP-T9                | Samsung  | MP3 Player         | SI-M500L  | Sharp   | 256MB MP3 Player |
| YP-ST5               | Samsung  | MP3 Player         | H10       | Iriver  | MP3 Player       |
| YP-T5                | Samsung  | MP3 Player         | YP-T10    | Samsung | MP3 Player       |
| YP-K5                | Samsung  | MP3 Player         | YP-P2     | Samsung | MP3 Player       |

## CAUTIONS ON HANDLING AND STORING DISCS

Small scratches on the disc may reduce sound and picture quality or cause skipping.  
Be especially careful not to scratch discs when handling them.

### Handling discs

Do not touch the playback side of the disc.  
Hold the disc by the edges so that fingerprints will not get on the surface.  
Do not stick paper or tape on the disc.

### Disc Storage

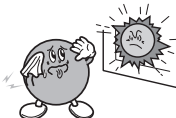
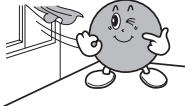
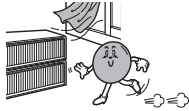
| Do not keep in direct sunlight  | Keep in a cool ventilated area  | Keep in a clean Protection jacket.<br>Store vertically.                             |
|---|---|---|
|  |  |  |

- 
  - Do not allow the discs to become contaminated with dirt.
  - Do not load cracked or scratched discs.

### Handling and Storing Discs

When you get fingerprints or dirt on the disc, clean it with a mild detergent diluted in water and wipe with a soft cloth.

- When cleaning, wipe gently from the inside to the outside of the disc

- 
  - Condensation may form if warm air comes into contact with cold parts inside the player. When condensation forms inside the player, the player may not operate correctly. If this occurs, remove the disc and let the player stand for 1 or 2 hours with the power on.

# appendix

## SPECIFICATIONS

|              |                                  |  |
|--------------|----------------------------------|--|
| General      | Power Requirements               | AC 120V, 60Hz  |
|              | Power Consumption                | 80 W   |
|              | Weight                           | 7.9 lbs  |
|              | Dimensions                       | 16.9 (W) x 2.6 (H) x 13.6 (D) inches   |
|              | Operating Temperature Range      | +41°F to +95°F   |
|              | Operating Humidity Range         | 10 % to 75 %   |
| Disc         | DVD (Digital Versatile Disc)     | Reading Speed : 3.49 ~ 4.06 m/sec.<br>Approx. Play Time (Single Sided, Single Layer Disc) : 135 min. |
|              | CD : 5 inches (COMPACT DISC)     | Reading Speed : 4.8 ~ 5.6 m/sec.<br>Maximum Play Time : 74 min.                                      |
|              | CD : 3 1/2 inches (COMPACT DISC) | Reading Speed : 4.8 ~ 5.6 m/sec.<br>Maximum Play Time : 20 min.                                      |
|              |                                  |  |
| Video Output | Composite Video                  | 480i<br>1 channel : 1.0 Vp-p (75 Ω load)   |
|              | Component Video                  | 480i<br>Y : 1.0 Vp-p (75 load)<br>Pr : 0.70 Vp-p (75 Ω load)<br>Pb : 0.70 Vp-p (75 Ω load)           |
|              |                                  |  |
| Video/Audio  | HDMI                             | 1080p, 1080i, 720p, 480p   |
| Amplifier    | Front speaker output             | 166W x 2(3Ω)   |
|              | Center speaker output            | 166W (3Ω)  |
|              | Rear speaker output              | 166W x 2(3Ω)   |
|              | Subwoofer speaker output         | 170W(3Ω)   |
|              | Frequency range                  | 20Hz~20KHz   |
|              | S/N Ratio                        | 70dB   |
|              | Channel separation               | 60dB   |
|              | Input sensitivity                | (AUX)400mV   |

**HT-Z310**

| Speaker | Speaker system   | 5.1ch speaker system   |            |
|---------|--|--|------------|
|         |  | Front/Rear/Center  | Subwoofer  |
|         | Impedance  | 3 Ω  | 3 Ω        |
|         | Frequency range  | 140Hz~20KHz  | 45Hz~160Hz |
|         | Output sound pressure level  | 86dB/W/M   | 86dB/W/M   |
|         | Rated input  | 166W   | 170W       |
|         | Maximum input  | 332W   | 340W       |
|         | Dimensions (W x H x D)   | Front/Rear : 3.5 x 5.39 x 3.6 inches<br>Center : 11.8 x 4.0 x 3.6 inches<br>Subwoofer : 7.1 x 12.6 x 15.0 inches |            |
| Weights | Front : 1.3 lbs, Rear : 1.1 lbs,<br>Center : 2.0 lbs<br>Subwoofer : 10.0 lbs |  |            |

**HT-TZ312**

| Speaker | Speaker system  | 5.1ch speaker system   |             |            |
|---------|---|--|-------------|------------|
|         |   | Front/Rear   | Center      | Subwoofer  |
|         | Impedance   | 3 Ω  | 3 Ω         | 3 Ω        |
|         | Frequency range   | 160Hz~20KHz  | 160Hz~20KHz | 45Hz~170Hz |
|         | Output sound pressure level   | 86dB/W/M   | 86dB/W/M    | 88dB/W/M   |
|         | Rated input   | 166W   | 166W        | 170W       |
|         | Maximum input   | 332W   | 332W        | 340W       |
|         | Dimensions (W x H x D)  | Front : 3.5 x 40.1 x 3.6 inches (Stand : 11.0 x 11.0)<br>Rear : 3.5 x 5.4 x 3.6 inches<br>Center : 11.8 x 4.0 x 3.6 inches<br>Subwoofer : 7.1 x 12.6 x 15.0 inches |             |            |
| Weights | Front : 6.6 lbs, Center : 1.9 lbs<br>Rear : 1.0 lbs, Subwoofer : 10.0 lbs |  |             |            |

\*: Nominal specification

- Samsung Electronics Co., Ltd reserves the right to change the specifications without notice.
- Weight and dimensions are approximate.

# WARRANTY

---

## LIMITED WARRANTY TO ORIGINAL PURCHASER

This SAMSUNG brand product, as supplied and distributed by Samsung Electronics America, Inc. (SAMSUNG) and delivered new, in the original carton to the original consumer purchaser, is warranted by SAMSUNG against manufacturing defects in materials and workmanship for a limited warranty period of:

### **One (1) Year Parts and Labor\***

#### **(\*90 Days Parts and Labor for Commercial Use)**

This limited warranty begins on the original date of purchase, and is valid only on products purchased and used in the United States. To receive warranty service, the purchaser must contact SAMSUNG for problem determination and service procedures. Warranty service can only be performed by a SAMSUNG authorized service center. The original dated bill of sale must be presented upon request as proof of purchase to SAMSUNG or SAMSUNG's authorized service center. Transportation of the product to and from the service center is the responsibility of the purchaser.

SAMSUNG will repair or replace this product, at our option and at no charge as stipulated herein, with new or reconditioned parts or products if found to be defective during the limited warranty period specified above. All replaced parts and products become the property of SAMSUNG and must be returned to SAMSUNG. Replacement parts and products assume the remaining original warranty, or ninety (90) days, whichever is longer.

SAMSUNG's obligations with respect to software products distributed by SAMSUNG under the SAMSUNG brand name are set forth in the applicable end user license agreement. Non-SAMSUNG hardware and software products, if provided, are on an "AS IS" basis. Non-SAMSUNG manufacturers, suppliers, publishers, and service providers may provide their own warranties.

This limited warranty covers manufacturing defects in materials and workmanship encountered in normal, and except to the extent otherwise expressly provided for in this statement, noncommercial use of this product, and shall not apply to the following, including, but not limited to: damage which occurs in shipment; delivery and installation; applications and uses for which this product was not intended; altered product or serial numbers; cosmetic damage or exterior finish; accidents, abuse, neglect, fire, water, lightning or other acts of nature; use of products, equipment, systems, utilities, services, parts, supplies, accessories, applications, installations, repairs, external wiring or connectors not supplied and authorized by SAMSUNG, or which damage this product or result in service problems; incorrect electrical line voltage, fluctuations and surges; customer adjustments and failure to follow operating instructions, cleaning, maintenance and environmental instructions that are covered and prescribed in the instruction book; product removal or reinstallation; reception problems and distortion related to noise, echo, interference or other signal transmission and delivery problems. SAMSUNG does not warrant uninterrupted or error-free operation of the product.

THERE ARE NO EXPRESS WARRANTIES OTHER THAN THOSE LISTED AND DESCRIBED ABOVE, AND NO WARRANTIES WHETHER EXPRESS OR IMPLIED, INCLUDING, BUT NOT LIMITED TO, ANY IMPLIED WARRANTIES OF MERCHANTABILITY OR FITNESS FOR A PARTICULAR PURPOSE, SHALL APPLY AFTER THE EXPRESS WARRANTY PERIODS STATED ABOVE, AND NO OTHER EXPRESS WARRANTY OR GUARANTY GIVEN BY ANY PERSON, FIRM OR CORPORATION WITH RESPECT TO THIS PRODUCT SHALL BE BINDING ON SAMSUNG. SAMSUNG SHALL NOT BE LIABLE FOR LOSS OF REVENUE OR PROFITS, FAILURE TO REALIZE SAVINGS OR OTHER BENEFITS, OR ANY OTHER SPECIAL, INCIDENTAL OR CONSEQUENTIAL DAMAGES CAUSED BY THE USE, MISUSE OR INABILITY TO USE THIS PRODUCT, REGARDLESS OF THE LEGAL THEORY ON WHICH THE CLAIM IS BASED, AND EVEN IF SAMSUNG HAS BEEN ADVISED OF THE POSSIBILITY OF SUCH DAMAGES. NOR SHALL RECOVERY OF ANY KIND AGAINST SAMSUNG BE GREATER IN AMOUNT THAN THE PURCHASE PRICE OF THE PRODUCT SOLD BY SAMSUNG AND CAUSING THE ALLEGED DAMAGE. WITHOUT LIMITING THE FOREGOING, PURCHASER ASSUMES ALL RISK AND LIABILITY FOR LOSS, DAMAGE OR INJURY TO PURCHASER AND PURCHASER'S PROPERTY AND TO OTHERS AND THEIR PROPERTY ARISING OUT OF THE USE, MISUSE OR INABILITY TO USE THIS PRODUCT SOLD BY SAMSUNG NOT CAUSED DIRECTLY BY THE NEGLIGENCE OF SAMSUNG. THIS LIMITED WARRANTY SHALL NOT EXTEND TO ANYONE OTHER THAN THE ORIGINAL PURCHASER OF THIS PRODUCT, IS NONTRANSFERABLE AND STATES YOUR EXCLUSIVE REMEDY.

Some states do not allow limitations on how long an implied warranty lasts, or the exclusion or limitation of incidental or consequential damages, so the above limitations or exclusions may not apply to you. This warranty gives you specific legal rights, and you may also have other rights which vary from state to state.

To obtain warranty hardware service, please contact SAMSUNG at:

Samsung Electronics America, Inc.  
105 Challenger Road Ridgefield Park, NJ 07660-0511  
1-800-SAMSUNG (726-7864) and [www.samsung.com/us](http://www.samsung.com/us)



## Contact SAMSUNG WORLD WIDE

If you have any questions or comments relating to Samsung products, please contact the SAMSUNG customer care center.

| Region               | Country                | Customer Care Center ☎   | Web Site              |
|----------------------|------------------------|--|-----------------------|
| North America        | CANADA                 | 1-800-SAMSUNG(726-7864)  | www.samsung.com/ca    |
|                      | MEXICO                 | 01-800-SAMSUNG(726-7864)   | www.samsung.com       |
|                      | U.S.A                  | 1-800-SAMSUNG(726-7864)  | www.samsung.com       |
| Latin America        | ARGENTINE              | 0800-333-3733  | www.samsung.com/ar    |
|                      | BRAZIL                 | 0800-124-421 , 4004-0000   | www.samsung.com       |
|                      | CHILE                  | 800-SAMSUNG(726-7864)  | www.samsung.com/cl    |
|                      | NICARAGUA              | 00-1800-5077267  |                       |
|                      | HONDURAS               | 800-7919267  |                       |
|                      | COSTA RICA             | 0-800-507-7267   | www.samsung.com/latin |
|                      | ECUADOR                | 1-800-10-7267  | www.samsung.com/latin |
|                      | EL SALVADOR            | 800-6225   | www.samsung.com/latin |
|                      | GUATEMALA              | 1-800-299-0013   | www.samsung.com/latin |
|                      | JAMAICA                | 1-800-234-7267   | www.samsung.com/latin |
|                      | PANAMA                 | 800-7267   | www.samsung.com/latin |
|                      | PUERTO RICO            | 1-800-682-3180   | www.samsung.com/latin |
|                      | REP. DOMINICA          | 1-800-751-2676   | www.samsung.com/latin |
|                      | TRINIDAD & TOBAGO      | 1-800-SAMSUNG(726-7864)  | www.samsung.com/latin |
|                      | VENEZUELA              | 0-800-100-5303   | www.samsung.com/latin |
| Europe               | COLOMBIA               | 01-8000112112  | www.samsung.com.co    |
|                      | BELGIUM                | 0032 (0)2 201 24 18  | www.samsung.com/be    |
|                      | CZECH REPUBLIC         | 844 000 844<br>Distributor pro Českou republiku:<br>Samsung Zrt., česká organizační složka<br>Vyskočilova 4, 14000 Praha 4 | www.samsung.com/cz    |
|                      | DENMARK                | 70 70 19 70  | www.samsung.com/dk    |
|                      | FINLAND                | 030-6227 515   | www.samsung.com/fi    |
|                      | FRANCE                 | 3260 SAMSUNG (€ 0,15/Min),<br>08 25 08 65 65 (€ 0,15/Min)  | www.samsung.com       |
|                      | GERMANY                | 01805 - SAMSUNG(726-7864) (€ 0,14/Min)   | www.samsung.com       |
|                      | HUNGARY                | 06-80-SAMSUNG(726-7864)  | www.samsung.com       |
|                      | ITALIA                 | 800-SAMSUNG(726-7864)  | www.samsung.com       |
|                      | LUXEMBURG              | 0035 (0)2 261 03 710   | www.samsung.com/be    |
|                      | NETHERLANDS            | 0900-SAMSUNG(726-7864) (€ 0,10/Min)  | www.samsung.com/nl    |
|                      | NORWAY                 | 815-56 480   | www.samsung.com/no    |
|                      | POLAND                 | 0 801 801 881 , 022-607-93-33  | www.samsung.com/pl    |
|                      | PORTUGAL               | 80820-SAMSUNG(726-7864)  | www.samsung.com/pt    |
|                      | SLOVAKIA               | 0800-SAMSUNG(726-7864)   | www.samsung.com/sk    |
|                      | SPAIN                  | 902 10 11 30   | www.samsung.com       |
|                      | SWEDEN                 | 0771-400 200   | www.samsung.com/se    |
|                      | U.K                    | 0845 SAMSUNG (7267864)   | www.samsung.com       |
|                      | EIRE                   | 0818 717 100   | www.samsung.com/ie    |
|                      | AUSTRIA                | 0800-SAMSUNG(726-7864)   | www.samsung.com/at    |
| SWITZERLAND          | 0800-SAMSUNG(726-7864) | www.samsung.com/ch   |                       |
| CIS                  | RUSSIA                 | 8-800-555-55-55  | www.samsung.com       |
|                      | KAZAHSTAN              | 8-10-800-500-55-500  | www.samsung.kz        |
|                      | UZBEKISTAN             | 8-10-800-500-55-500  | www.samsung.uz        |
|                      | KYRGYZSTAN             | 00-800-500-55-500  |                       |
|                      | TADJIKISTAN            | 8-10-800-500-55-500  |                       |
|                      | UKRAINE                | 8-800-502-0000   | www.samsung.com       |
|                      | LITHUANIA              | 8-800-77777  | www.samsung.lt        |
|                      | LATVIA                 | 800-7267   | www.samsung.com/lv    |
|                      | ESTONIA                | 800-7267   | www.samsung.ee        |
| Asia Pacific         | AUSTRALIA              | 1300 362 603   | www.samsung.com       |
|                      | NEW ZEALAND            | 0800SAMSUNG(726-7864)  | www.samsung.com/nz    |
|                      | CHINA                  | 800-810-5858 , 010-6475 1880   | www.samsung.com       |
|                      | HONG KONG              | 3698-4698  | www.samsung.com/hk    |
|                      | INDIA                  | 3030 8282 , 1800 110011  | www.samsung.com       |
|                      | INDONESIA              | 0800-112-8888  | www.samsung.com       |
|                      | JAPAN                  | 0120-327-527   | www.samsung.com/jp    |
|                      | MALAYSIA               | 1800-88-9999   | www.samsung.com/my    |
|                      | PHILIPPINES            | 1800-10-SAMSUNG(726-7864)  | www.samsung.com/ph    |
|                      | SINGAPORE              | 1800-SAMSUNG(726-7864)   | www.samsung.com       |
|                      | THAILAND               | 1800-29-3232 , 02-689-3232   | www.samsung.com       |
|                      | TAIWAN                 | 0800-329-999   | www.samsung.com/tw    |
| VIETNAM              | 1 800 588 889          | www.samsung.com  |                       |
| Middle East & Africa | TURKEY                 | 444 77 11  | www.samsung.com       |
|                      | SOUTH AFRICA           | 0860-SAMSUNG(726-7864 )  | www.samsung.com       |
|                      | U.A.E                  | 800-SAMSUNG (726-7864), 8000-4726  | www.samsung.com       |