



MC17F808KDT

# Microwave Oven

## user manual

imagine the possibilities

Thank you for purchasing this Samsung product.

**SAMSUNG**

# safety information

---

Congratulations on your new Samsung microwave oven. This manual contains important information on the installation, use and care of your appliance. Please take time to read this manual to take full advantage of your microwave oven's many benefits and features.

## **WHAT YOU NEED TO KNOW ABOUT SAFETY INSTRUCTIONS**

---

Warnings and Important Safety Instructions in this manual do not cover all possible conditions and situations that may occur. It is your responsibility to use common sense, caution, and care when installing, maintaining, and operating your microwave oven.

## **PRECAUTIONS TO AVOID POSSIBLE EXPOSURE TO EXCESSIVE MICROWAVE ENERGY**











---

- A.** Do not attempt to operate this oven with the door open since open-door operation can result in harmful exposure to microwave energy. It is important not to defeat or tamper with the safety interlocks.
- B.** Do not place any object between the oven front face and the door or allow soil or cleaner residue to accumulate on the sealing surface.
- C.** Do not operate the oven if it is damaged. It is particularly important that the oven door close properly and that there is no damage to the:
  - 1.** Door (bent),
  - 2.** Hinges and latches, (broken or loosened),
  - 3.** Door seals and sealing surface.
- D.** Only properly qualified service personnel should adjust or repair the oven. Do not attempt to adjust or repair the oven yourself.

## **SAVE THESE INSTRUCTIONS**

# IMPORTANT SAFETY SYMBOLS AND PRECAUTIONS

What the icons and signs in this user manual mean:

 <b>WARNING</b>	Hazards or unsafe practices that may result in <b>severe personal injury or death.</b>
 <b>CAUTION</b>	Hazards or unsafe practices that may result in <b>minor personal injury or property damage.</b>
 <b>CAUTION</b>	To reduce the risk of fire, explosion, electric shock, or personal injury when using your microwave oven, follow these basic safety precautions.
	Do NOT attempt.
	Do NOT disassemble.
	Do NOT touch.
	Follow directions explicitly.
	Unplug the power plug from the wall socket.
	Make sure the machine is grounded to prevent electric shock.
	Call the service center for help.
	Note

These warning signs are here to prevent injury to you and others. Please follow them explicitly. After reading this section, keep it in a safe place for future reference.

## STATE OF CALIFORNIA PROPOSITION 65 WARNING (US ONLY)

WARNING : This product contains chemicals known to the State of California to cause cancer and birth defects or other reproductive harm.

## IMPORTANT SAFETY INSTRUCTIONS

When using any electrical appliance, basic safety precautions should be followed, including the following:

### **WARNING**

To reduce risk of burns, electric shock, fire, personal injury or exposure to excessive microwave energy:

1. Read all safety instructions before using the appliance.
2. Read and follow the specific "Precautions to avoid possible exposure to excessive microwave energy" on page 2.
3. This appliance must be grounded. Connect only to properly grounded outlets. See Important "Grounding instructions" on page 5 of this manual.
4. Install or locate this appliance only in accordance with the provided installation instructions.

**SAVE THESE INSTRUCTIONS**

5. Some products such as whole eggs and sealed containers (for example, closed glass jars) can explode if heated rapidly. Never heat them in a microwave oven.
6. Use this appliance only for its intended use as described in the manual. Do not put corrosive chemicals or vapors in or on this appliance. This type of oven is specifically designed to heat, cook, or dry food. It is not designed for industrial or laboratory use.
7. As with any appliance, close supervision is necessary when it is used by children. Keep children away from the door when opening or closing it as they may bump themselves on the door or catch their fingers in the door.
8. Do not operate this appliance if it has a damaged cord or plug, if it is not working properly, or if it has been damaged or dropped.
9. This appliance should be repaired or serviced only by qualified service personnel. Contact the nearest authorized service facility for examination, repair, or adjustment.
10. Do not cover or block any openings on the appliance.
11. Do not tamper with or make any adjustments or repairs to the door.
12. Do not store this appliance outdoors. Do not use this product near water, for example, near a kitchen sink, in a wet basement, near a swimming pool, or similar locations.
13. Do not immerse the cord or plug in water.
14. Keep the cord away from heated surfaces. (including the back of the oven).
15. Do not let the cord hang over edge of table or counter.
16. When cleaning surfaces of the door and oven that come together when the door closes, use only mild, nonabrasive soaps, or detergents applied with a sponge or soft cloth. Unplug the plug before cleaning.
17. To reduce the risk of fire in the oven cavity:
  - a. Do not overcook food. Carefully attend appliance when paper, plastic, or other combustible materials are placed inside the oven to facilitate cooking.
  - b. Remove wire twist-ties from paper or plastic bags before placing the bags in the oven.
  - c. If materials inside the oven ignite, keep the oven door closed, turn the oven off, and disconnect the power cord, or shut off the power at the fuse or circuit breaker panel. If the door is opened, the fire may spread.
  - d. Do not use the cavity for storage purposes. Do not leave paper products, cooking utensils, or food in the cavity when not in use.
18. Liquids, such as water, milk, coffee, or tea can be overheated beyond the boiling point without appearing to be boiling. Visible bubbling or boiling when the container is removed from the microwave oven is not always present. THIS COULD RESULT IN VERY HOT LIQUIDS SUDDENLY BOILING OVER WHEN THE CONTAINER IS DISTURBED OR A SPOON OR OTHER UTENSIL IS INSERTED INTO THE LIQUID. To reduce the risk of injury:
  - a. Do not overheat liquid.
  - b. Stir liquid both before and halfway through heating it.
  - c. Do not use straight-sided containers with narrow necks.
  - d. After heating, allow the container to stand in the microwave oven for a short time before removing the container.
  - e. Use extreme care when inserting a spoon or other utensil into the container.
19. Oversized foods or oversized metal utensils should not be inserted in microwave / toaster oven as they may create a fire or electric shock.
20. Do not clean with metal scouring pads. Piece can burn off the pad and touch electrical parts involving a risk of electric shock.

## SAVE THESE INSTRUCTIONS

- 21.** Do not use paper products when appliance is operated in the toaster mode.
- 22.** Do not store any materials, other than manufacturer's recommended accessories, in this oven when not in use.
- 23.** Do not cover racks or any other part of the oven with metal foil . This will cause overheating of the oven.



## CAUTION

---

- 1.** Clean Ventilating Hoods Frequently - Grease should not be allowed to accumulate on the hood of the filter.
- 2.** When flaming foods under the hood, turn the fan on.
- 3.** Use care when cleaning the vent-hood filter. Corrosive cleaning agents, such as lye-based oven cleaner, may damage the filter.

## GROUNDING INSTRUCTIONS

---

This appliance must be grounded. In the event of an electrical short circuit, grounding reduces the risk of electric shock by providing an escape wire for the electrical current. This appliance is equipped with a cord that includes a grounding wire and a grounding plug. The plug must be plugged into an outlet that is properly installed and grounded.



## WARNING

---

Improper use of the grounding plug can result in a risk of electric shock.

- Plug into a grounded 3 prong outlet. Do not remove the third (grounding) prong. Do not use an adaptor or otherwise defeat the grounding plug.
- Consult a qualified electrician or service person if you do not understand the grounding instructions or if you are not sure if the appliance is properly grounded.
- We do not recommend using an extension cord with this appliance. If the power-supply cord is too short, have a qualified electrician or serviceman install an outlet near the appliance. However, if it is necessary to use an extension cord, read and follow the "Use of Extension Cords" section below.

## Use of Extension Cords

---

A short power-supply cord is provided to reduce the risk of your becoming entangled in or tripping over a longer cord. Longer cord sets or extension cords are available and you can use them if you exercise care. If you use a long cord or extension cord:

- 1.** The marked electrical rating of the cord set or extension cord should be at least as great as the electrical rating of the appliance.
- 2.** The extension cord must be a grounding-type 3-wire cord and it must be plugged into a 3-slot outlet.
- 3.** The longer cord should be arranged so that it will not drape over the counter top or tabletop where it can be pulled on by children or tripped over accidentally. If you use an extension cord, the interior light may flicker and the speed of the blower may vary when the microwave oven is on. Cooking times may be longer too.

**SAVE THESE INSTRUCTIONS**



WARNING

## CRITICAL INSTALLATION WARNINGS

---

- ★ The installation of this appliance must be performed by a qualified technician or service company.

- Failing to have a qualified technician install the oven may result in electric shock, fire, an explosion, problems with the product, or injury.

Unpack the oven, remove all packaging material and examine the oven for any damage such as dents on the interior or exterior of the oven, broken door latches, cracks in the door, or a door that is not lined up correctly. If there is any damage, do not operate the oven and notify your dealer immediately.

Make sure to install your oven in a location with adequate space.

Remove all foreign substances such as dust or water from the power plug terminals and contact points using a dry cloth on a regular basis.

- Unplug the power plug and clean it with a dry cloth.
- Failing to do so may result in electric shock or fire.

Plug the power cord into a properly grounded 3 pronged outlet. Your oven should be the only appliance connected to this circuit.

- Sharing a wall socket with other appliances, using a power strip, or extending the power cord may result in electric shock or fire.
- Do not use an electric transformer. It may result in electric shock or fire.
- Ensure that the voltage, frequency and current provided match the product's specifications. Failing to do so may result in electric shock or fire.

Keep all packaging materials out of the reach of children. Children may use them for play.



This appliance must be properly grounded. Read and follow the specific "Grounding instructions" found in the beginning of this Section. Do not ground the appliance to a gas pipe, plastic water pipe, or telephone line.

- This may result in electric shock, fire, an explosion, or problems with the product.
- Never plug the power cord into a socket that is not grounded correctly and make sure that it is grounded in accordance with local and national codes.

Do not cut or remove the third (ground) prong from the power cord under any circumstances.

Connect the oven to a 20A circuit. If you connect the oven to a 15A circuit, make sure that the circuit breaker is operable.



Do not install this appliance in a humid, oily, or dusty location, or in a location exposed to direct sunlight or water (rain drops).

- This may result in electric shock or fire.

Plug the power plug into the wall socket firmly. Do not use a damaged power plug, damaged power cord, or loose wall socket.

- This may result in electric shock or fire.

## SAVE THESE INSTRUCTIONS

 Do not mount over a sink.

Do not pull or excessively bend the power cord.

Do not twist or tie the power cord.

Do not hook the power cord over a metal object, place a heavy object on the power cord, insert the power cord between objects, or push the power cord into the space behind the appliance.

- This may result in electric shock or fire.

Do not pull the power cord when you unplug the oven.

- Unplug the oven by pulling the plug only.

- Failing to do so may result in electric shock or fire.

---

 When the power plug or power cord is damaged, contact your nearest service center for a replacement or repair.



## INSTALLATION CAUTIONS

---

 Position the oven so that the plug is easily accessible.

- Failing to do so may result in electric shock or fire due to electric leakage.

---

 Unplug the oven when it is not being used for long periods of time or during a thunder/lightning storm.

- Failing to do so may result in electric shock or fire.



## CRITICAL USAGE WARNINGS

---

 If the microwave appliance is flooded, please contact your nearest service center. Failing to do so may result in electric shock or fire.

Read and follow the specific “Precautions to Avoid Possible Exposure to Excessive Microwave Energy”, found in the beginning of this Safety Information Section.

If the microwave generates a strange noise, a burning smell or smoke, unplug it immediately and contact your nearest service center.

- Failing to do so may result in electric shock or fire.

In the event of a gas leak (propane gas, LP gas, etc.), ventilate the room immediately. Do not touch the microwave, power cord, or plug.

- Do not use a ventilating fan.

- A spark may result in an explosion or fire.

Take care that the door or any of the other parts do not come into contact with your body while cooking or just after cooking.

- Failing to do so may result in burns.

In the event of a grease fire on the surface units below the oven, smother the flaming pan on the surface unit by covering the pan completely with a lid, a cookie sheet, or a flat tray.

## SAVE THESE INSTRUCTIONS

- ★ Never leave surface units beneath your oven unattended at high heat settings. Boil overs cause smoking and greasy spillovers that may ignite and spread if the vent fan is operating. To minimize automatic fan operation, use adequate sized cookware and use high heat on surface units only when necessary.

If materials inside the oven should ignite, keep the oven door closed, turn the oven off and disconnect the power cord, or shut off power at the fuse or circuit breaker panel. If the door is opened, the fire may spread.

- Always observe Safety Precautions when using your oven. Never try to repair the oven on your own. There is dangerous voltage inside. If the oven needs to be repaired, contact an authorized service center near you.
- 

- ✘ Do not attempt to repair, disassemble, or modify the appliance yourself.
    - Because a high voltage current enters the product chassis during operation, opening the chassis can result in electric shock or fire.
    - You may be exposed to electromagnetic waves.
    - When the oven requires repair, contact your nearest service center.
- 

- 🔌 If any foreign substance such as water enters the microwave, unplug it and contact your nearest service center.
    - Failing to do so may result in electric shock or fire.
- 

- ⚠ Do not touch the power plug with wet hands.
  - This may result in electric shock.

Do not turn the appliance off by unplugging the power plug while the appliance is in operation.

- Plugging the power plug into the wall socket again may cause a spark and result in electric shock or fire.

Keep all packaging materials well out of the reach of children. Packaging materials can be dangerous to children.

- If a child places a bag over its head, the child can suffocate.

Do not let children or any person with reduced physical, sensory or mental capabilities use this appliance unsupervised.

Make sure that the appliance is out of the reach of children.

- Failing to do so may result in electric shock, burns or injury.

Do not touch the inside of the appliance immediately after cooking. The inside of the appliance will be hot.

- The heat on the inside of the oven can cause burns.

Do not put aluminum foil (except as specifically directed in this manual), metal objects (such as containers, forks, etc.) or containers with golden or silver rims into the microwave.

- These objects can cause sparks or a fire.

Do not use or place flammable sprays or objects near the oven.

- Heat from the microwave can cause flammable sprays to explode or burn.

## SAVE THESE INSTRUCTIONS



- Failing to do so may result in electric shock or injury.

Do not tamper with or make any adjustments or repairs to the door. Under no circumstances should you remove the outer cabinet.

Do not store or use the oven outdoors.



## USAGE CAUTIONS

---

- ★ If the surface of the microwave is cracked, turn it off.

- Failing to do so may result in electric shock.

Dishes and containers can become hot. Handle with care.

Hot foods and steam can cause burns. Carefully remove container coverings, directing steam away from your hands and face.

Remove lids from baby food before heating. After heating baby food, stir well to distribute the heat evenly. Always test the temperature by tasting before feeding the baby. The glass jar or surface of the food may appear to be cooler than the food in the interior, which can be so hot that it will burn the infant's mouth.

Make sure all cookware used in the oven is suitable for microwaving.

Use microwavable cookware in strict compliance with such manufacturer's recommendations.

- ☐ Do not stand on top of the microwave or place objects (such as laundry, oven covers, lighted candles, lighted cigarettes, dishes, chemicals, metal objects, etc.) on the appliance.

- Items, such as a cloth, may get caught in the door.
- This may result in electric shock, fire, problems with the product, or injury.

Do not operate the appliance with wet hands.

- This may result in electric shock.

Do not spray volatile material such as insecticide onto the surface of the appliance.

- As well as being harmful to humans, it may also result in electric shock, fire or problems with the product.

Do not place the appliance over a fragile object such as a sink or glass object.

- This may result in damage to the sink or glass object.

Do not put your face or body close to the appliance while cooking or when opening the door just after cooking.

- Take care that children do not come too close to the appliance.
- Failing to do so may result in children burning themselves.

Do not place food or heavy objects over the door when opening the door.

- The food or object may fall and this may result in burns or injury.

## SAVE THESE INSTRUCTIONS

-  Do not abruptly cool the door, the inside of the appliance, or the dish by pouring water over it during or just after cooking.
- This may result in damage to the appliance. The steam or water spray may result in burns or injury.

Do not cook without the glass tray in place on the oven floor. Food will not cook properly without the tray.

Do not defrost frozen beverages in narrow-necked bottles. The containers can break.

Do not scratch the glass of the oven door with a sharp object.

- This may result in the glass being damaged or broken.

Do not store anything directly on top of the appliance when it is in operation.

Do not use sealed containers. Remove seals and lids before use. Sealed containers can explode due to buildup of pressure even after the oven has been turned off.



## **CRITICAL CLEANING INSTRUCTIONS**

---

Do not clean the appliance by spraying water directly onto it.

Do not use benzene, thinner, or alcohol to clean the appliance.

- This may result in discoloration, deformation, damage, electric shock, or fire.

Before cleaning or performing maintenance, unplug the appliance from the wall socket and remove food waste from the door and cooking compartment.

- Failing to do so may result in electric shock or fire.

Take care not to hurt yourself when cleaning the appliance. (external/internal)

- You may hurt yourself on the sharp edges of the appliance.

Do not clean the appliance with a steam cleaner.

- This may result in corrosion.

Keep the inside of the oven clean. Food particles or spattered oils stuck to the oven walls or floor can cause paint damage and reduce the efficiency of the oven.

## **SAVE THESE INSTRUCTIONS**

# contents

---

## **SETTING UP YOUR NEW MICROWAVE OVEN**

Checking the parts . . . . .	12
Setting up your microwave oven . . . . .	13
Checking the control panel . . . . .	14
Turning on the power and setting the clock . . . . .	15
Using my setting feature . . . . .	15
Selecting the display weight . . . . .	15
Setting the 12hr/24hr . . . . .	15
Selecting the sound . . . . .	16
Setting the word speed . . . . .	16
Setting the remind end signal . . . . .	16
Setting the daylight saving time adjustment . . . . .	16
Setting the key lock . . . . .	16
Setting the demo mode . . . . .	16
Setting the clock . . . . .	16

## **USING YOUR MICROWAVE OVEN**

Using the kitchen timer . . . . .	17
Using the stop/clear button . . . . .	17
Using the microwave +30 sec. feature . . . . .	17
Using the more/less feature . . . . .	17
Turning on the light . . . . .	17
Turning on the vent . . . . .	17
Eco mode . . . . .	18
Warm hold . . . . .	18
Using steam clean . . . . .	18
Turning on the turntable . . . . .	18
Using the defrost button . . . . .	19
Accessory usage . . . . .	19
Using the slim fry button . . . . .	20
Using the FIT CHOICE button . . . . .	21
Using the speed cook button . . . . .	24
Using the auto cook button . . . . .	28
Using the express menu feature . . . . .	33
Using the microwave setting cooking times & power levels . . . . .	34
Brown . . . . .	35
Bake / Roast . . . . .	35
Speed bake / Roast . . . . .	35
Speed bake/roast guide . . . . .	36

## **COOKWARE GUIDE**

Recommended cooking utensils . . . . .	37
Limited use items . . . . .	37
Not recommended . . . . .	37
Testing utensils . . . . .	37

## **COOKING GUIDE**

Cooking techniques . . . . .	38
General microwave tips . . . . .	38
Guide for cooking eggs in your microwave . . . . .	39
Guide for cooking vegetables in your microwave . . . . .	39

## **CLEANING AND MAINTAINING YOUR MICROWAVE OVEN**

Cleaning the exterior . . . . .	40
Cleaning the interior . . . . .	40
Cleaning the turntable and roller rings . . . . .	40
Storing and repairing your microwave oven . . . . .	41
Replacing the cooktop/night light . . . . .	41
Replacing the oven light . . . . .	41
Cleaning the grease filter . . . . .	42
Replacing the charcoal filter . . . . .	43

## **TROUBLESHOOTING**

Check these points if your microwave oven . . . . .	44
---	----

## **APPENDIX**

Specifications . . . . .	45
--------------------------	----

## **WARRANTY**

Warranty and service information . . . . .	45
Samsung over-the-range (otr) microwave oven . . . . .	46

# setting up your new microwave oven

---

Be sure to follow these instructions closely so that your new microwave oven works properly.

## CHECKING THE PARTS

---

Carefully unpack your microwave oven, and make sure you've received all the parts shown below. If your microwave oven was damaged during shipping, or if you do not have all the parts, contact Samsung Customer Service. (Refer to the "WARRANTY AND SERVICE INFORMATION" on page 45.)

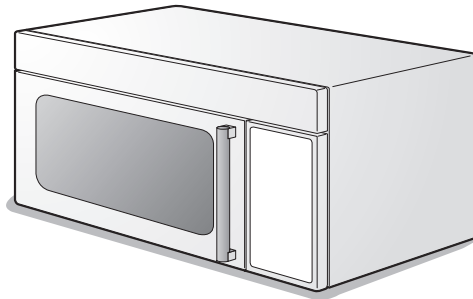

Microwave oven



\* Ceramic Enamel Tray



\* Glass Tray



\* Roller Guide Ring

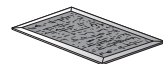

\* Grease Filter (Installed)

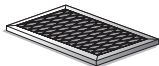

\* Charcoal filter

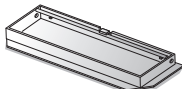

\* Exhaust adaptor



\* Hardware kit (Screws & Brackets)

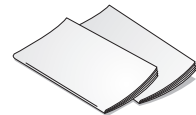

Manuals (User & Installation)

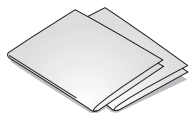

Templates (Top & Wall)



Cooking Guide Manual



\* Low Rack

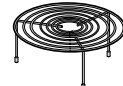

\* Medium Rack



\* High Rack

If you need an accessory marked with a \*, you can buy it from the Samsung Contact Center (1-800-726-7864) or on-line web site ([www.samsungparts.com](http://www.samsungparts.com))

## SETTING UP YOUR MICROWAVE OVEN

1. Open the door by pulling the handle on the right side of the door.
2. Wipe the inside of the oven with a damp cloth.

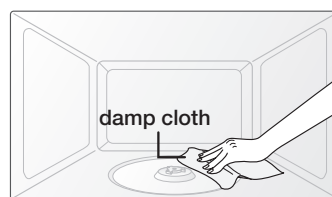

3. Install the pre-assembled ring into the indentation at the center of the microwave oven.

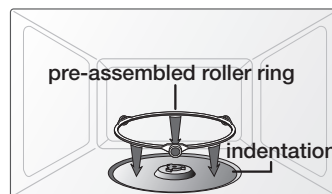

4. Place the glass tray securely in the center of the pre-assembled roller ring.

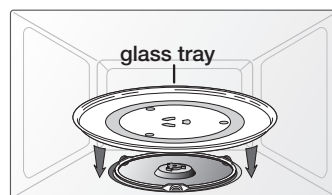

### Installing the metal shelf

When you need to use the Metal Shelf, place it on the plastic hooks inside your oven and make sure it is positioned properly to avoid arcing and damaging your oven.



CAUTION Make sure the shelf is positioned properly inside the microwave to prevent damage to the oven from arcing.

# CHECKING THE CONTROL PANEL

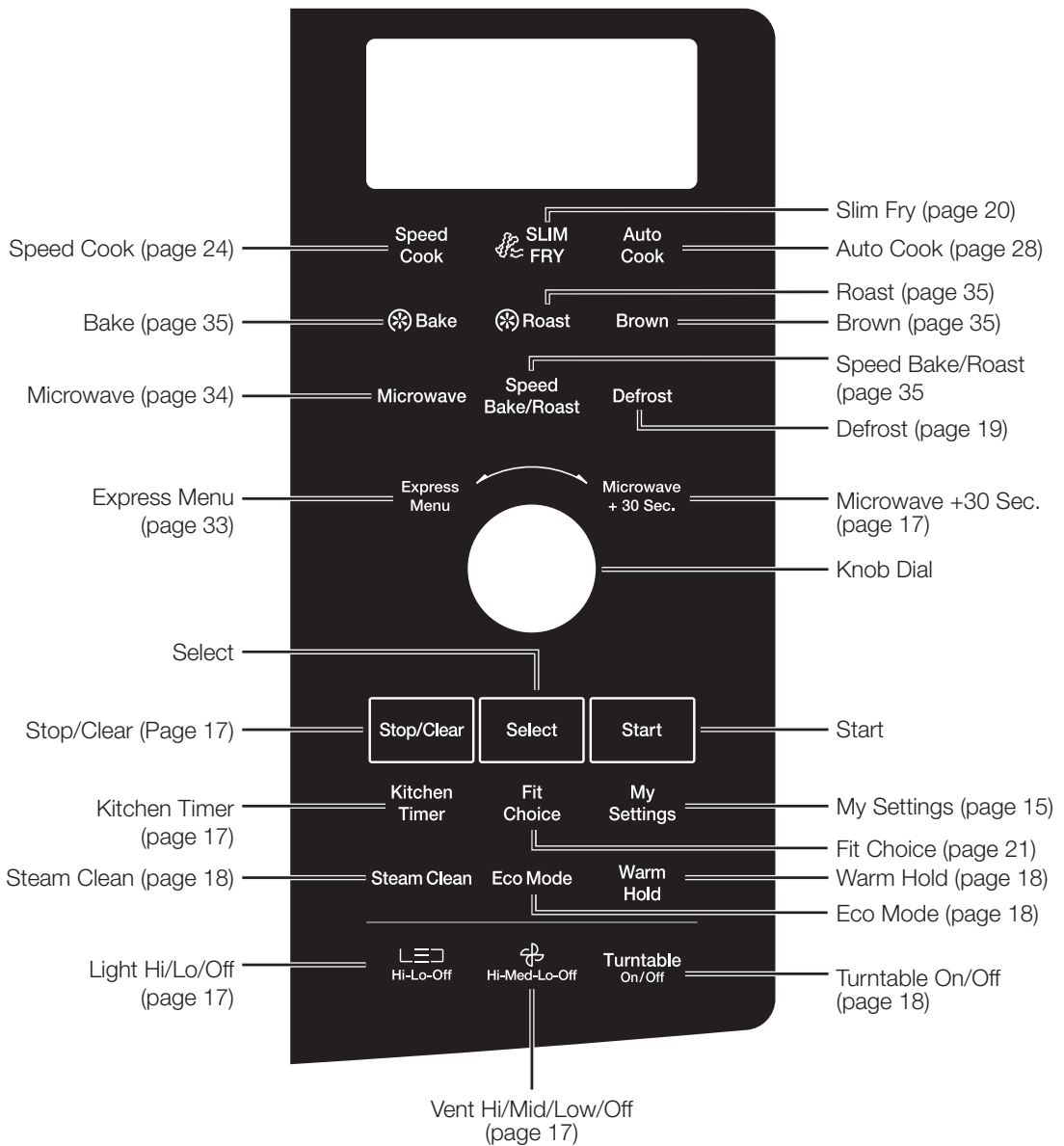

## TURNING ON THE POWER AND SETTING THE CLOCK

1. The first time you plug in the power chord, the display shows : **SET HOUR**
2. Using the knob dial, dial the hour, and then press the **Select** button.  
The display shows : **SET MIN**
3. Dial the minutes, and then press the **Select** button.  
The display shows: **SET AM/PM**
4. Dial AM or PM, and then press the **Select** button.  
The display will show the clock.

## USING MY SETTING FEATURE

Your new microwave oven can be customized to suit your personal tastes.

Simply press My Settings to set these options. For your convenience, all the options are summarized in the following table :

Item No.	Settings options	Description	Operation
1	Display Weight	Weight options are pounds and kilograms.	Press My Settings, dial 1 and select by pressing the <b>Select</b> button.
2	12HR/24HR	The clock can display either 12HR or 24HR time modes.	Press My Settings, dial 2 and select by pressing the <b>Select</b> button.
3	Sound	Sound volume can be turned On and Off.	Press My Settings, dial 3 and select by pressing the <b>Select</b> button.
4	Word Scroll Speed	There are three speeds, Low, Medium, and High. The default is Medium Speed.	Press My Settings, dial 4 and select by pressing the <b>Select</b> button.
5	Remind End Signal	The Remind End Signal can be turned On and Off.	Press My Settings, dial 5 and select by pressing the <b>Select</b> button.
6	Daylight Savings Time Adjustment	The time can be advanced one hour for DST without resetting the clock.	Press My Settings, dial 6 and select by pressing the <b>Select</b> button.
7	Key Lock	This feature prevents use by unsupervised children.	Press My Settings, dial 7 and select by pressing the <b>Select</b> button.
8	Demo Mode	The Demo Mode can be turned On and Off.	Press My Settings, dial 8 and select by pressing the <b>Select</b> button.
9	Clock	The clock can be adjusted.	Press My Settings, dial 9 and select by pressing the <b>Select</b> button.

- If there is a power interruption, you will need to reset these options.

## SELECTING THE DISPLAY WEIGHT

You can choose between pounds (lbs.) and kilograms (kg).

1. Press the **My Settings** button, dial **1-WEIGHT**, and then press the **Select** button.  
The display shows : **WEIGHT**
2. Dial LBS or KG.
3. Press the **Select** button repeatedly to select the weight measurements you want to use.

## SETTING THE 12HR/24HR

1. Press the **My Settings** button, dial **2-12/24 HR**, and then press the **Select** button.  
The display will show: **12HR/24HR**
2. Dial **12HR** or **24HR**.
3. Press the **Select** button.

## SELECTING THE SOUND

---

1. Press the **My Settings** button, dial **3-SOUND**, and then press the **Select** button.  
The display shows : **SOUND**
2. Dial On or Off.
3. Press the **Select** button.

## SETTING THE WORD SPEED

---

1. Press the **My Settings** button, dial **4-SCROLL**, and then press the **Select** button.  
The display shows : **SCROLL**
2. Dial the scroll speed.
3. Press the **Select** button.

## SETTING THE REMIND END SIGNAL

---

The Remind End Signal can be set On or Off.

1. Press the **My Settings** button, dial **5-REMIND**, and then press the **Select** button.  
The display shows : **REMIND**
2. Dial On or Off.
3. Press the **Select** button.

## SETTING THE DAYLIGHT SAVING TIME ADJUSTMENT

---

1. Press the **My Settings** button, dial **6-DAY.SAV**, and then press the **Select** button.  
The display shows : **DAYLIGHT SAV.**
2. Dial On or Off.
3. Press the **Select** button. Time of day will advance one hour. If you select OFF, the time will go back one hour.

If the clock is set for standard time, this function allows you to change the time easily without needing to reset the clock. Daylight Saving Time begins for most of the United States at 2 a.m. on the first Sunday of April and reverts to Standard time at 2 a.m. on the last Sunday of October.

## SETTING THE KEY LOCK

---

1. Press the **My Settings** button, dial **7-KEY LOC**, and then press the **Select** button.  
The display shows : **KEY LOCK**
2. Dial On or Off.
3. Press the **Select** button.

## SETTING THE DEMO MODE

---

1. Press the **My Settings** button, dial **8-DEMO**, and then press the **Select** button.  
The display shows : **DEMO MODE**
2. Dial On or Off.
3. Press the **Select** button.

## SETTING THE CLOCK

---

1. Press the **My Settings** button, dial **9-CLOCK** and then press the **Select** button.  
The display shows : **SET HOUR**
2. Dial the hour, and then press the **Select** button.  
The display shows : **SET MIN**
3. Dial the minutes, and then press the **Select** button.  
The display shows: **SET AM/PM**
4. Dial AM or PM, and then press the **Select** button.  
The display will show the clock.



# using your microwave oven

## USING THE KITCHEN TIMER

1. Press the **Kitchen Timer** button. (max. time 90 min.)  
The display shows: **SET MIN**
2. Use the dial to set the number of minutes you want the timer to run.
3. Press the **Select** button.  
The display shows: **SET SEC**
4. Use the dial to set the number of additional seconds you want the timer to run.
5. Press the **Select** button.  
The display counts down and beeps when the time has elapsed.

## USING THE STOP/CLEAR BUTTON

The **Stop/Clear** button allows you to clear instructions you have entered.

It also allows you to pause the oven's cooking cycle, so that you can check the food.

- To pause the oven during cooking, press the **Stop/Clear** button once. To restart, press the **Start** button.
- To stop cooking, erase instructions, and return the oven display to the time of day, press the **Stop/Clear** button twice.
- To clear instructions you have just entered, press the **Stop/Clear** button once, then re-enter the instructions.
- To cancel a timer setting, press the **Stop/Clear** button once.

## USING THE MICROWAVE +30 SEC. FEATURE

This feature offers a convenient way to heat food in set time increments at the High power level.

1. Dial in the **Microwave +30 Sec.** direction (clockwise) to increase the time you want food to cook. The time will display. Press the **Start** button to begin cooking.

If the Total Cooking Time is Between	The Cooking Time Increases in These Increments
30 seconds ~ 1 minute	5 seconds
1 minute ~ 3 minutes	10 seconds
3 minutes ~ 10 minutes	30 seconds
10 minutes ~ 20 minutes	1 minute
20 minutes ~ 60 minutes	2 minutes
60 minutes ~ 90 minutes	5 minutes

2. Add cooking time to a program in progress by dialing in the **Microwave +30 Sec.** direction (clockwise). As you dial clockwise, you increase the cooking time by set increments.

## USING THE MORE/LESS FEATURE

The More or Less feature allows you to adjust the pre-set cooking time. It works with 1 and 2 stage cooking, MW, Bake, Roast, Brown, Speed Bake/Roast, and Warm Hold buttons.

Use the More or Less feature only after cooking has begun.

1. To ADD more time to a cooking procedure, dial in the clockwise direction. Each step adds 5 seconds to the cooking time.
2. To REDUCE the time of a cooking procedure, dial in the counter-clockwise direction. Each step reduces the cooking time by 5 seconds.

## TURNING ON THE LIGHT

Press the  button to turn the light on or off. Press once for high, twice for low, three times to turn the light off.

## TURNING ON THE VENT

The vent fan removes steam and other vapors from rangetop cooking.

Press the  button once for fan speed high, twice for fan speed medium, three times for fan speed Low, and four times to turn the fan off.

-  The Vent Fan protects the microwave from excess heat rising from the cooktop below it. It automatically turns on if it senses too much heat. If you have turned the fan on, you may find that you cannot turn it off. The fan will automatically turn off when the internal parts are cool. It may stay on for 30 minutes or more after the cooktop and microwave controls are turned off.

## ECO MODE

---

Eco Mode reduces standby power usage.

When you press the **ECO MODE** button once, the display will go out and the microwave shifts to the mode which minimizes power usage.

To cancel the **ECO MODE**, press the **ECO MODE** button once again, or press any other button.

## WARM HOLD

---

You can keep cooked food warm in your microwave oven for up to 90 minutes.

1. Press **Warm Hold** button.
2. Enter the cooking time.
3. Press **Enter/Start** button.

 **Warm Hold** operates for up to 90 minutes.

 **Food that is cooked covered** should also be covered during **Warm Hold**.

 Pastry items (pies, turnovers, etc.) should be uncovered during **Warm Hold**.

 Complete meals kept warm on a dinner plate can be covered during **Warm Hold**.

Below are the amounts of food we recommend you apply the Warm and Hold function to by Food Type.

Food type	Recommended Quantity
Liquid	1-2 cups
Dry	5-10 oz.

## USING STEAM CLEAN

---

The steam provided by the steam clean system will soak the cavity surface.

After using the steam clean function, you can easily clean the cavity of the oven.

1. Open the door.
2. Carefully pour about 2fl.oz. of water into a wide plate.
3. Place the plate on the tray of microwave oven.
4. Close the door.
5. Press the **Steam Clean** button, and then the **Start** button.  
Steam clean will operate for 6 minutes and 30 seconds. The length of time cannot be modified.
6. When the cleaning time is over, the oven will beep. Open the door.
7. Clean the cavity of the oven with a dry dishtowel. Remove the turntable and wipe under the rack with a piece of paper towel.

 Use this function only after the oven has completely cooled.

 Use normal tap water only. Do not use distilled water.

 The water in the oven will be very hot due to the steam cleaning function. Wipe up carefully.  
CAUTION

## TURNING ON THE TURNTABLE

---

For best cooking results, leave the turntable on. It can be turned off for large dishes.

Press the Turntable button to turn the **turntable** on or off.

**Sometimes the turntable can become too hot to touch.** Be careful when you touch the turntable during and after cooking.

## USING THE DEFROST BUTTON

Remove all packaging material before defrosting. Place meat, poultry, fish, bread, etc. on a ceramic plate. General defrosting instructions:

1. Place the food on the turntable (glass tray).
2. Press the **Defrost** button.
3. Dial the Food you want to defrost, and then press the **Select** button.
4. Dial the amount of food, and then press the **Start** button.

For specific instructions for different kinds of food, see the table below.

COOK NO	FOOD	AMOUNT	STANDING TIME	REMARK
1	MEAT	0.1~6.0 lbs.	5-10 min	Shield the edges with aluminium foil. Turn the meat over when the oven beeps. This program is suitable for lamb, pork, steaks, chops, and ground meat. For ground meat, place the meat directly on the turntable tray on wax paper. Do not use an extra tray. Let stand, covered with foil, for 5-10 minutes.
2	POULTRY	0.1~6.0 lbs.	30-60 min	Shield the leg and wing tips with aluminium foil. Turn the poultry over when the oven beeps. This program is suitable for whole chicken as well as for chicken portions.
3	FISH	0.1~6.0 lbs.	20-60 min	Shield the tail of a whole fish with aluminium foil. Turn the fish over when the oven beeps. This program is suitable for whole fish as well as for fish fillets.
4	BREAD	0.1~2.0 lbs	5-20 min	Put bread on a piece of paper towel. Turn over as soon as the oven beeps. Place cake on a ceramic plate and if possible, turn over as soon as the oven beeps. (The oven keeps operating and stops only when you open the door.) This program is suitable for all kinds of bread, sliced or whole, as well as for bread rolls and baguettes. Arrange bread rolls in a circle.

 Check foods when the oven signals. After the final stage, small sections may still be icy. Let them stand to continue thawing. Food is not fully defrosted until all ice crystals have thawed. Shielding roasts and steaks with small pieces of foil prevents the edges from cooking before the center of the food has defrosted. Use narrow, flat, smooth strips of aluminum foil to cover the edges and thinner sections of the food.

## ACCESSORY USAGE

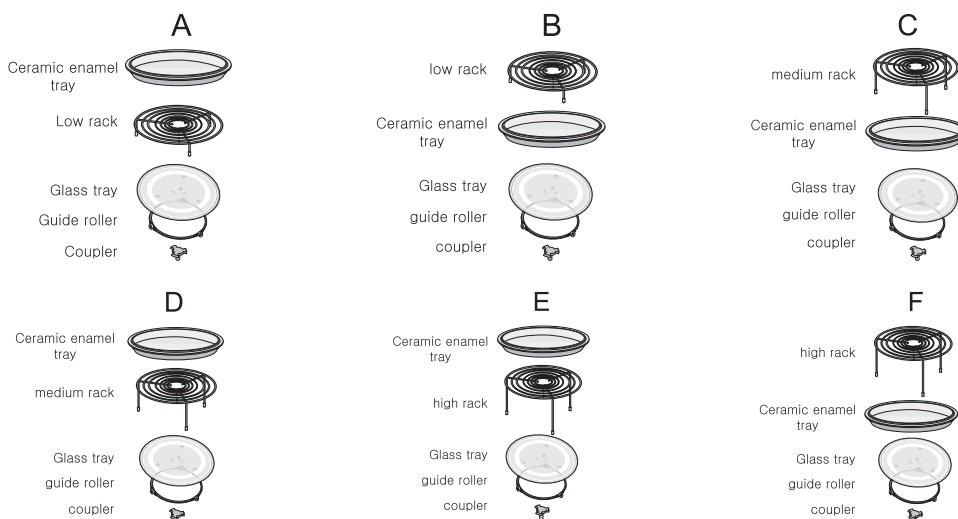



## USING THE SLIM FRY BUTTON

The Slim Fry menu contains pre-set cooking programs for 9 different items.

1. Place the food on the tray or the rack. (See Accessory Usage on page 19 and 20)
2. Press the **Slim Fry** button.
3. Dial the food you want to cook, and then press the **Select** button. (For the items that you do not need to set the amount for, press **Start**.)
4. Dial the amount of food, and then press the **Start** button.

Cook No.	Food	Amount	Directions	Accessory Type
1	<b>FROZEN OVEN CHIPS</b>	2 servings (8oz) 4 servings (16oz)	Place frozen french fries on ceramic enamel tray then on high rack.	E
2	<b>FROZEN PRAWNS, BREADED</b>	2 servings (8oz) 4 servings (16oz)	Place frozen prawns on med rack then ceramic enamel tray. When the oven beeps, turn over them and re-start the oven.	D
3	<b>FROZEN CHICKEN NUGGETS</b>	1 serving (5ea) 2 servings (10ea) (5 ea per serving)	Place chicken nuggets on the ceramic enamel tray then med rack.	D
4	<b>FROZEN MINI SPRING ROLLS</b>	1 serving (6oz) 2 servings (24oz)	Place frozen spring rolls on ceramic enamel tray then on med rack.	D
5	<b>HOMEMADE FRENCH FRIES</b>	2 servings (8oz) 4 servings (12oz)	Peel potatoes and cut into sticks with a thickness of 10×10mm. Soak in cold water for 30-40mins(put some salt in the cold water for the osmotic pressure.) Dry them with a towel then brush with 5g oil. (Have to remove the moisture completely. Otherwise, potatoes may get scorched and stick to the bottom of the tray.) Place them on greased ceramic enamel tray then on high rack.	E
6	<b>FROZEN POTATO WEDGES</b>	2 servings (8oz) 4 servings (16oz)	Place frozen potato wedges on greased ceramic enamel tray then on high rack.	E
7	<b>FROZEN POTATO CROQUETTES</b>	2 servings (8oz) 4 servings (16oz)	Place frozen potato croquettes on greased ceramic enamel tray then on med rack. When the oven beeps, turn over them and re-start the oven.	D
8	<b>DRUMSTICKS</b>	1 serving (12oz) 2 servings (24oz) (4 pcs per serving)	Rinse drumsticks and place them on high rack directly then on ceramic enamel tray.	E
9	<b>SLICED COURGETTES</b>	2 servings (8oz) 4 servings (16oz)	Cut courgettes and brush them with 5g oil. Place sliced courgettes on med rack then greased ceramic enamel tray. When the oven beeps, turn over them and re-start the oven.	D

## USING THE FIT CHOICE BUTTON

The Fit Choice menu contains pre-set cooking programs for 30 different items.

1. Place the food on the tray or the rack. (See Accessory Usage on page 19 and 20)
2. Press the **Fit Choice** button.
3. Dial the category, and then press the **Select** button.
4. Dial the food you want to cook, and then press the **Select** button. (For items you do not need to set the amount for, press **Start**.)
5. Dial the amount of food, and then press **Start** button.

CATEGORY	Cook No.	FOOD	Amount	Directions	Accessory Type
1. FRESH VEGETABLES	1	<b>BROCCOLI</b>	1 serving 2 servings 3 servings 4 servings (1 serving = ½ cup or 5 florets)	Wash and clean the broccoli. Prepare the florets and place in a microwave safe bowl. Add 1-4 tablespoons of water (1 Tbsp per serving). Cover during cooking and stir afterwards.	G
	2	<b>CARROTS</b>	1 serving 2 servings 3 servings 4 servings (1 serving = ½ cup)	Wash and clean the carrots. Cut the carrots into even slices and place in a microwave safe bowl. Add 1-4 tablespoons of water (1 Tbsp per serving). Cover during cooking and stir afterwards.	G
	3	<b>GREEN BEANS</b>	1 serving 2 servings 3 servings 4 servings (1 serving = ½ cup)	Wash and clean the green beans. Place the green beans in a microwave safe bowl. Add 1-4 tablespoons of water (1 Tbsp per serving). Cover during cooking and stir afterwards.	G
	4	<b>SPINACH</b>	1 serving 2 servings 3 servings 4 servings (1 serving = 1 cup)	Wash and clean the spinach. Place the spinach in a microwave safe bowl. Add 1-4 tablespoons of water (1 Tbsp per serving). Cover during cooking and stir afterwards.	G
	5	<b>SQUASH</b>	1-2lbs (0.5-0.9kg) 2-3lbs (0.9-1.4kg)	Slice the squash in half and remove the seeds. Place the squash cut side down in a microwave safe dish and add a ¼ cup of water.	G
2. FROZEN VEGETABLES	1	<b>BROCCOLI</b>	1 serving 2 servings 3 servings 4 servings (1 serving = ½ cup or 5 florets)	Place the broccoli in a microwave safe bowl. Add 1-4 tablespoons of water (1 Tbsp per serving). Cover during cooking and stir afterwards.	G
	2	<b>CARROTS</b>	1 serving 2 servings 3 servings 4 servings (1 serving = ½ cup)	Place the carrots in a microwave safe bowl. Add 1-4 tablespoons of water (1 Tbsp per serving). Cover during cooking and stir afterwards.	G
	3	<b>CORN</b>	1 serving 2 servings 3 servings 4 servings (1 serving = ½ cup)	Place the corn in a microwave safe bowl. Add 1-4 tablespoons of water (1 Tbsp per serving). Cover during cooking and stir afterwards.	G

CATEGORY	Cook No.	FOOD	Amount	Directions	Accessory Type
2. FROZEN VEGETABLES	4	<b>GREEN BEANS</b>	1 serving 2 servings 3 servings 4 servings (1 serving = ½ cup)	Place the green beans in a microwave safe bowl. Add 1-4 tablespoons of water (1 Tbsp per serving). Cover during cooking and stir afterwards.	G
	5	<b>PEAS</b>	1 serving 2 servings 3 servings 4 servings (1 serving = ½ cup)	Place the peas in a microwave safe bowl. Add 1-4 tablespoons of water (1 Tbsp per serving). Cover during cooking and stir afterwards.	G
3. CANNED VEGETABLES	1	<b>CARROTS</b>	1 serving 2 servings 3 servings 4 servings (1 serving = ½ cup)	Place the carrots in a microwave safe bowl. Cover during cooking and stir afterwards.	G
	2	<b>CORN</b>	1 serving 2 servings 3 servings 4 servings (1 serving = ½ cup)	Place the corn in a microwave safe bowl. Cover during cooking and stir afterwards.	G
	3	<b>GREEN BEANS</b>	1 serving 2 servings 3 servings 4 servings (1 serving = ½ cup)	Place the green beans in a microwave safe bowl. Cover during cooking and stir afterwards.	G
	4	<b>PEAS</b>	1 serving 2 servings 3 servings 4 servings (1 serving = ½ cup)	Place the peas in a microwave safe bowl. Cover during cooking and stir afterwards.	G
	5	<b>SPINACH</b>	1 serving 2 servings 3 servings 4 servings (1 serving = 1 cup)	Place the spinach in a microwave safe bowl. Cover during cooking and stir afterwards.	G
	6	<b>BEANS</b>	1 serving 2 servings 3 servings 4 servings (1 serving = ½ cup or 5 florests)	Place the beans in a microwave safe bowl. Cover during cooking and stir afterwards.	G
4. GRAIN	1	<b>OATMEAL</b>	1 pack 2 packs	Follow the package directions for the recommended amount of water needed. Stir well before and afterwards.	G
	2	<b>BROWN RICE</b>	2 servings 4 servings (1 serving = ½ cup)	Place 0.5 cup brown rice+2cups water for 2 servings and 1 cup brown rice + 3 cups water for 4 servings in a microwave safe bowl. Stir well before and fluff with a fork afterwards. Let stand 5 minutes before serving.	G

CATEGORY	Cook No.	FOOD	Amount	Directions	Accessory Type
4. GRAIN	3	<b>BULGUR</b>	2 servings 4 servings (1 serving = ½ cup)	Follow the package directions for the recommended amount of water needed. Stir well before and fluff with a fork afterwards.	G
	4	<b>WHOLE WHEAT MACARONI</b>	2 servings 4 servings (1 serving = ½ cup)	Follow the package directions for the recommended amount of water needed. Carefully remove from the microwave and drain the hot water.	G
	5	<b>QUINOA</b>	2 servings 4 servings (1 serving = ½ cup)	Follow the package directions for the recommended amount of water needed. When the microwave beeps, stir well and restart the microwave.	G
	6	<b>WHOLE WHEAT COUSCOUS</b>	2 servings 4 servings (1 serving = ½ cup)	Follow the package directions for the recommended amount of water needed. Pour the water into a microwave safe bowl and place in the microwave. When the microwave beeps, add couscous and restart the microwave. Fluff with a fork afterwards.	G
5. POULTRY	1	<b>CHICKEN BREAST</b>	2 Pieces 4 Pieces (6 oz. each)	Place the chicken breasts on the high rack, then place the rack on the ceramic enamel tray. When the microwave beeps, turn over the chicken breasts and restart the microwave.	F
	2	<b>BONE-IN CHICKEN PIECES</b>	2 servings (18 oz.) 4 servings (36 oz.)	Brush the chicken pieces with oil and seasonings. Place the pieces skin side up on the high rack, then place the rack on the ceramic enamel tray.	F
	3	<b>TURKEY BREAST</b>	4 pieces (12 oz. - each 3 oz.)	Place the turkey breasts on the high rack, then place the rack on the ceramic enamel tray. When the microwave beeps, turn over the turkey breasts and restart the microwave.	F
	4	<b>GROUND TURKEY</b>	4 Servings(1 lb.)	Place the ground turkey in a microwave safe 2 quart casserole dish. When the microwave beeps, stir and restart the microwave.	G
6. SEAFOOD	1	<b>WHITE FISH FILLET</b>	1 serving (2 pieces, 4 oz.) 2 servings (4 pieces, 8 oz.) (1 servings = 2 pcs, each pices = 2 oz.)	Spray the high rack with a non-stick spray. Place the fillets (cod, pollack, etc.) on the high rack, then place the rack on the ceramic enamel tray.	F
	2	<b>SALMON FILLET</b>	1 serving (1 pieces, 4 oz.) 2 servings (2 pieces, 8 oz.) (1 servings = 1 pc, each pices = 4 oz.)	Spray the high rack with a non-stick spray. Place the salmon fillets on the high rack, then place the rack on the ceramic enamel tray.	F

CATEGORY	Cook No.	FOOD	Amount	Directions	Accessory Type
6. SEAFOOD	3	<b>TILAPIA FILLET</b>	1 serving (2 pieces, 4 oz.) 2 servings (4 pieces, 8 oz.) (1 servings = 2 pcs, each pices = 2 oz.)	Spray the high rack with a non-stick spray. Place the tilapia fillets on the high rack, then place the rack on the ceramic enamel tray.	F
	4	<b>TUNA STEAK</b>	1 serving (1 pieces, 4 oz.) 2 servings (2 pieces, 8 oz.) (1 servings = 1 pc, each pices = 4 oz.)	Spray the high rack with a non-stick spray. Place the tuna steaks on the high rack, then place the rack on the ceramic enamel tray. When the microwave beeps, turn over the tuna steaks and restart the microwave.	F

## USING THE SPEED COOK BUTTON

The Speed Cook menu contains pre-set cooking programs for 43 different items.

1. Place the food on the tray or the rack. (See Accessory Usage on page 19 and 20)
2. Press the **Speed Cook** button.
3. Dial the category, and then press the **Select** button.
4. Dial the food you want to cook, and then press the **Select** button. (For the items that you do not need to set the amount for, press **Start**.)
5. Dial the amount of food, and then press the **Start** button.

CATEGORY	Cook No.	FOOD	Amount	Directions	Accessory Type
1. BREAKFAST	1	<b>FRENCH TOAST, FROZEN</b>	2 servings 4 servings (1 serving = 1 Toast)	Place the french toast on the high rack, then place the rack on the ceramic enamel tray. Turn over the pieces when the microwave beeps and restart the microwave.	F
	2	<b>FRENCH TOAST STICKS</b>	1 serving 2 servings (1 serving = 5 Sticks)	Place the french toast sticks on the high rack, then place the rack on the ceramic enamel tray. Turn over the sticks when the microwave beeps and restart the microwave.	F
	3	<b>SAUSAGE LINKS, FRESH</b>	2 servings 4 servings (1 serving = 3 Links)	Place the sausage links on the ceramic enamel tray, then place the tray on the high rack. Turn over the links when the microwave beeps and restart the microwave.	E
	4	<b>SAUSAGE LINKS, FROZEN</b>	2 servings 4 servings (1 serving = 3 Links)	Place the sausage links on the ceramic enamel tray, then place the tray on the high rack.	E
	5	<b>SAUSAGE PATTIES, FROZEN</b>	2 servings (4 patties) 4 servings (8 patties) (1 serving = 2 Patties)	Place the sausage patties on the ceramic enamel tray, then place the tray on the high rack.	E
	6	<b>SAUSAGE PATTIES, FRESH</b>	2 servings (2 patties) 4 servings (4 patties) (1 serving = 1 Patties)	Place the sausage patties on the ceramic enamel tray, then place the tray on the high rack. When the microwave beeps, turn over the sausage patties and restart the microwave.	E



CATEGORY	Cook No.	FOOD	Amount	Directions	Accessory Type
1. BREAKFAST	7	<b>TOASTER ITEMS</b>	2 servings 4 servings (1 serving = 1 Toast)	Place the toaster item on the high rack, then place the rack on the ceramic enamel tray. Turn over the items when the microwave beeps and restart the microwave.	F
	8	<b>WAFFLES, FROZEN</b>	2 servings 3 servings (1 serving= 2 Waffles)	Place the waffles on the low rack, then place the rack on the ceramic enamel tray. Turn over the waffles when the microwave beeps and restart the microwave.	B
2. POULTRY	1	<b>CHICKEN BREAST</b>	2 Pieces 4 Pieces (6 oz. each)	Place the chicken breast on the high rack, then place the rack on the ceramic enamel tray. Turn over the chicken when the microwave beeps and restart the microwave.	F
	2	<b>BONE-IN CHICKEN PIECES</b>	2 servings (18 oz.) 4 servings (36 oz.)	Place the chicken pieces on the high rack, then place the rack on the ceramic enamel tray.	F
	3	<b>WHOLE CHICKEN</b>	3~4 lbs.	Fold the wings under the chicken. Place the chicken on the low rack, then place the rack on the ceramic enamel tray. Brush the chicken with melted butter/oil and seasonings.	B
	4	<b>TURKEY BREAST</b>	4 pieces (12 oz - each 3 oz.)	Place the turkey breasts on the high rack, then place the rack on the ceramic enamel tray. When the microwave beeps, turn the turkey breasts over and restart the microwave.	F
3. SEAFOOD	1	<b>WHITE FISH FILLET</b>	1 serving (2 pieces, 4 oz.) 2 servings (4 pieces, 8 oz.) (1 serving = 2 pcs, each piece = 2 oz.)	Spray the high rack with non stick spray. Place the fillets (cod, pollack, etc.) on the high rack, then place the rack on the ceramic enamel tray.	F
	2	<b>SALMON FILLET</b>	1 serving (1 pieces, 4 oz.) 2 servings (2 pieces, 8 oz.) (1 serving = 1 pc, each piece = 4 oz.)	Spray the high rack with non stick spray. Place the salmon fillets on the high rack, then place the rack on the ceramic enamel tray.	F
	3	<b>SHRIMP, FRESH</b>	2 servings (8 oz.) 4 servings (16 oz.)	Place the shrimp on the ceramic enamel tray, then place the tray on the high rack. When the microwave beeps, turn over the shrimp and restart the microwave.	E
	4	<b>TUNA STEAK</b>	1 serving (1 pieces, 4 oz.) 2 servings (2 pieces, 8 oz.) (1 serving = 1 pc, each piece = 4 oz.)	Spray the high rack with non stick spray. Place the tuna steaks on the high rack, then place the rack on the ceramic enamel tray. When the microwave beeps, turn over the tuna steaks and restart the microwave.	F

CATEGORY	Cook No.	FOOD	Amount	Directions	Accessory Type
4. BEEF	1	<b>BEEF ROAST</b>	2 lbs (0.91kg) 3 lbs (1.36kg)	Place the roast on the low rack, then place the rack on the ceramic enamel tray. When the microwave beeps, turn over the roast and restart the microwave.	B
	2	<b>TOP LOIN STEAK, MEDIUM</b>	1 inch, 0.5 lb.	Place the steak on the high rack, then place the rack on the ceramic enamel tray. When the microwave beeps, turn over the steak and restart the microwave. Let the steak rest for 5 minutes before slicing.	F
	3	<b>TOP LOIN STEAK, WELL DONE</b>	1 inch, 0.5 lb.	Place the steak on the high rack, then place the rack on the ceramic enamel tray. When the microwave beeps, turn over the steak and restart the microwave. Let the steak rest for 5 minutes before slicing.	F
	4	<b>TOP ROUND STEAK, MEDIUM</b>	3/4 Inch, 1 lb.	Place the steak on the high rack, then place the rack on the ceramic enamel tray. When the microwave beeps, turn over the steak and restart the microwave. Let the steak rest for 5 minutes before slicing.	F
	5	<b>TOP ROUND STEAK, WELL DONE</b>	3/4 Inch, 1 lb.	Place the steak on the high rack, then place the rack on the ceramic enamel tray. When the microwave beeps, turn over the steak and restart the microwave. Let the steak rest for 5 minutes before slicing.	F
	6	<b>SIRLOIN STEAK, MEDIUM</b>	1 Inch, 1 lb.	Place the steak on the high rack, then place the rack on the ceramic enamel tray. When the microwave beeps, turn over the steak and restart the microwave. Let the steak rest for 5 minutes before slicing.	F
	7	<b>SIRLOIN STEAK, WELL DONE</b>	1 Inch, 1 lb.	Place the steak on the high rack, then place the rack on the ceramic enamel tray. When the microwave beeps, turn over the steak and restart the microwave. Let the steak rest for 5 minutes before slicing.	F
	8	<b>GROUND BEEF</b>	2 servings (8 oz.) 4 servings (16 oz.)	Place the ground beef in a microwave safe 2 quart casserole dish. When the microwave beeps, stir and restart the microwave.	G
	9	<b>HAMBURGERS</b>	2 each (4 oz./each) 4 each (4 oz./each)	Place the hamburgers on the ceramic enamel tray, then place the tray on the high rack. When the microwave beeps, turn the hamburgers over and restart the microwave.	E

CATEGORY	Cook No.	FOOD	Amount	Directions	Accessory Type
5. PORK	1	<b>BONE-IN PORK CHOPS</b>	1 Servings 2 servings (1 serving = 6-8oz. each)	Place the pork chops on the high rack, then place the rack on the ceramic enamel tray. When the microwave beeps, turn over the pork chops and restart the microwave.	F
	2	<b>BONELESS PORK CHOPS</b>	2 Servings (2 ea.) 4 Servings (4 ea.) (1 serving = 4-5 oz. each)	Place the pork chops on the high rack, then place the rack on the ceramic enamel tray. When the microwave beeps, turn over the pork chops and restart the microwave.	F
	3	<b>PORK TENDERLOIN</b>	Small - 1 Piece (0.5-1 lbs) Large - 1 Piece (1.5-2 lbs)	Place the pork on the low rack, then place the rack on the ceramic enamel tray. When the microwave beeps, turn over the pork and restart the microwave.	B
6. PIZZA	1	<b>FROZEN PIZZA, INDIVIDUAL, 6 INCH</b>	6 inch	Place the pizza on the medium rack, then place the rack on the ceramic enamel tray.	C
	2	<b>FROZEN PIZZA, REGULAR, 12 INCH</b>	12 inch	Place the pizza on the medium rack, then place the rack on the ceramic enamel tray.	C
	3	<b>FROZEN INDIVIDUAL DEEP DISH PIZZA</b>	6 inch	Place the pizza on the medium rack, then place the rack on the ceramic enamel tray.	C
	4	<b>FROZEN RISING CRUST PIZZA</b>	12 inch	Place the pizza on the medium rack, then place the rack on the ceramic enamel tray.	C
7. POTATO	1	<b>BAKED POTATO</b>	2 ea. 4 ea. (8~10 oz./each)	Pierce the potatoes 3 times with a fork. Place the potatoes on the glass turntable with one end of the potato pointing towards the center. After cooking, let the potatoes stand for 3-5 minutes.	G
	2	<b>SWEET POTATO</b>	2 ea. 4 ea. (8~10 oz./each)	Pierce the sweet potatoes 3 times with a fork. Place the potatoes on the glass turntable with one end of the sweet potato pointing towards the center. After cooking, let the potatoes stand for 3-5 minutes.	G
8. SNACKS, FROZEN	1	<b>CHICKEN NUGGETS</b>	1 serving (5 ea.) 2 servings (10 ea.) (5 ea per serving)	Place the chicken nuggets on the ceramic enamel tray, then place the tray on the high rack.	E
	2	<b>CHICKEN TENDERS</b>	1 serving (5 ea.) 2 servings (10 ea.) (5 ea per serving)	Place the chicken tenders on the ceramic enamel tray, then place the tray on the high rack.	E

CATEGORY	Cook No.	FOOD	Amount	Directions	Accessory Type
8. SNACKS, FROZEN	3	<b>CHICKEN WINGS</b>	2 servings (10 ea.) 4 servings (20 ea.) (5 wings per serving)	Place the chicken wings on the low rack, then place the rack on the ceramic enamel tray.	B
	4	<b>FRIED CHICKEN</b>	2 servings 4 servings (1 piece per serving)	Place the chicken on the ceramic enamel tray, then place the tray on the low rack.	A
	5	<b>MEATBALL</b>	2 servings 4 servings (6 meatballs per serving)	Place the meatballs on the ceramic enamel tray, then place the tray on the medium rack.	D
	6	<b>CHEESE STICKS</b>	2 servings 4 servings (2 sticks per serving)	Place the cheese sticks on the ceramic enamel tray, then place the tray on the high rack.	E
	7	<b>ONION RINGS</b>	2 servings (6 ea.) 4 servings (12 ea.) (3 rings per serving)	Place the onion rings on the ceramic enamel tray, then place the tray on the medium rack. When the microwave beeps, turn over the onion rings and restart the microwave.	D
	8	<b>FRENCH FRIES</b>	2 servings (6 oz.) 4 servings (12 oz.) (3 oz. per serving)	Place the french fries on the ceramic enamel tray, then place the tray on the medium rack. When the oven beeps, turn over the french fries and restart the oven.	D
	9	<b>SWEET POTATO FRIES</b>	2 servings (6 oz.) 4 servings (12 oz.) (3 oz. per serving)	Place the sweet potato fries on the ceramic enamel tray, then place the tray on the medium rack. When the oven beeps, turn over the sweet potato fries and restart the oven.	D

## USING THE AUTO COOK BUTTON

The Auto Cook menu contains pre-set cooking programs for 48 different items.

1. Place the food on the tray or the rack. (See Accessory Usage on page 19 and 20)
2. Press the **Auto Cook** button.
3. Dial the category, and then press the **Select** button.
4. Dial the food you want to cook, and then press the **Select** button. (For items you do not need to set an amount for, press Start.)
5. Dial the amount of food, and then press the **Start** button.

CATEGORY	Cook No.	FOOD	Amount	Directions	Accessory Type
1. REHEAT	1	<b>SOUP, BROTH</b>	1 to 4 servings (8 oz./serving)	Pour the refrigerated soup into a microwave safe bowl. Cover with a lid or vented plastic wrap. Stir well before serving.	G
	2	<b>SOUP, CREAM</b>	1 to 4 servings (8 oz./serving)	Pour the refrigerated soup into a microwave safe bowl. Cover with a lid or vented plastic wrap. Stir well before serving.	G

CATEGORY	Cook No.	FOOD	Amount	Directions	Accessory Type
1. REHEAT	3	<b>PASTA</b>	1 to 4 servings (8 oz./serving)	Place the refrigerated pasta on a microwave safe plate or bowl. Cover with a lid or vented plastic wrap. Stir well before serving.	G
	4	<b>CASSEROLE</b>	1 to 4 servings (8 oz./serving)	Place the refrigerated casserole on a microwave safe plate or bowl. Cover with a lid or vented plastic wrap. Stir well before serving.	G
	5	<b>DINNER PLATE</b>	1 serving	Place the pre-cooked, refrigerated food on a microwave safe plate. Cover the plate with vented plastic wrap or wax paper.	G
	6	<b>BEVERAGE</b>	½ cup 1 cup 2 cups	Place the beverage in a microwave safe container.	G
	7	<b>ROLL</b>	1 to 4 rolls	Place the rolls on a microwave safe plate.	G
	8	<b>PIZZA REHEAT</b>	2 slices 4 slices (3~4 oz./each)	Place the pizza on a microwave safe plate. Do not overlap the slices or cover. Let stand 1-2 minutes before serving.	G
2. COOK	1	<b>FROZEN DINNER</b>	8-10 oz. (227-283g) 11-14 oz. (312-397g) 15-18 oz. (425-510g)	Remove the outer wrapping and follow the package directions for covering. Let stand 1-3 minutes before serving.	G
	2	<b>FROZEN BREAKFAST</b>	4-6 oz. (113-170g) 7-8 oz.(198-227g)	Remove the outer wrapping and follow the package directions for covering. Let stand 1-3 minutes before serving. When microwave beeps, stir and restart.	G
	3	<b>MASHED POTATOES, INSTANT</b>	2 servings 4 servings (1 serving = 1/3 Cup Flakes)	Follow the package preparation directions.	G
	4	<b>BACON, UNCOOKED</b>	2 slices 4 slices 6 slices	Layer 2 paper towels on a microwave safe plate and arrange the bacon on the towels. Do not overlap bacon. Cover with an additional paper towel. Remove the paper towel immediately after cooking.	G
	5	<b>BACON, PRE-COOKED</b>	2 slices 4 slices 6 slices	Layer 2 paper towels on a microwave safe plate and arrange the bacon on the towels. Do not overlap the bacon. Cover with an additional paper towel. Remove the paper towel immediately after cooking.	G

CATEGORY	Cook No.	FOOD	Amount	Directions	Accessory Type
3. KIDS MENU	1	<b>CHICKEN NUGGETS</b>	1 serving 2 servings. (1 serving = 5 ea.)	Arrange the nuggets in an evenly spaced circle on top of a paper towel on a microwave safe plate. Do not cover. Let stand 1 minute before serving.	G
	2	<b>HOT DOGS</b>	2 each 4 each	Pierce the hot dogs 3 times with a fork and place on a microwave safe plate. When the microwave beeps, add the buns and restart the microwave.	G
	3	<b>CANNED PASTA</b>	1 serving - 7.5 oz. (213g) 2 servings - 15 oz. (425g)	Pour into a microwave safe bowl. Cover with a lid or vented plastic wrap. Stir well before serving.	G
	4	<b>BURRITO</b>	1 Each 2 Each	Follow the package preparation directions. Let stand 1-2 minutes before serving.	G
	5	<b>SNACK POCKET</b>	1 serving (1 ea.) 2 servings (2 ea.)	Follow the package preparation directions. Let stand 1-2 minutes before serving.	G
4. PASTA	1	<b>SPAGHETTI</b>	1 servings (2 oz.) 2 servings (4 oz.)	Place 4 (for 2 servings) or 8 (for 4 servings) cups of water in a large microwave safe bowl. When the microwave beeps, add spaghetti and restart the microwave. Drain the hot water carefully.	G
	2	<b>MACARONI AND CHEESE</b>	1 serving (1 ea.) 2 servings (2 ea.)	Follow the package preparation instructions.	G
	3	<b>INSTANT NOODLES</b>	1 serving (1 ea.) 2 servings (2 ea.)	Place the noodles in a microwave safe bowl and add 2 (for 2 servings) or 4 (for 4 servings) cups of water. After cooking, drain off the desired amount of water and add seasoning.	G
5. BREAD	1	<b>BISCUITS, REFRIGERATED</b>	10 ea.	Preheat the microwave to 375 °F. Place the biscuits on the greased ceramic enamel tray, then place the tray on the low rack.	A
	2	<b>BREAD STICKS</b>	12 ea.	Preheat the microwave to 375 °F. Place the breadsticks on the greased ceramic enamel tray, then place the tray on the low rack.	A
	3	<b>CRESCENT ROLLS, REFRIGERATED, SMALL</b>	8 ea.	Preheat the microwave to 375 °F. Place the rolls on the greased ceramic enamel tray, then place the tray on the low rack.	A
	4	<b>CRESCENT ROLLS, REFRIGERATED, LARGE</b>	8 ea.	Preheat the microwave to 375 °F. Place the rolls on the greased ceramic enamel tray, then place the tray on the low rack.	A

CATEGORY	Cook No.	FOOD	Amount	Directions	Accessory Type
6. BAKED GOODS	1	<b>BOX CAKE MIX</b>	1 package	Preheat the microwave to 350 °F. Pour the batter into 2- 8 inch microwave safe round cake pans. Place one filled pan on the middle rack then place the second batter filled pan on the low rack (under the middle rack).	A + D (Except Ceramic enamel tray)
	2	<b>CINNAMON ROLLS</b>	8 ea.	Preheat the microwave to 375 °F. Place the rolls on the greased ceramic enamel tray, then place the tray on the low rack.	A
	3	<b>BROWNIE MIX</b>	1 package	Preheat the microwave to 350 °F. Pour the batter into an 8x8 inch microwave safe pan, then place the pan on the low rack.	A
	4	<b>COOKIE DOUGH, SLICED</b>	8 ea. (1/2 inch sliced)	Preheat the microwave to 375 °F. Place 8 cookies on the greased ceramic enamel tray, then place the tray on medium rack.	D
	5	<b>COOKIE DOUGH, PRE FORMED</b>	10 ea.	Preheat the microwave to 375 °F. Place 10 cookies on the greased ceramic enamel tray, then place the tray on the medium rack.	D
	6	<b>TURNOVERS, REFRIGERATED</b>	2 servings (2 ea.) 4 servings (4 ea.)	Preheat the microwave to 425 °F. Follow the package preparation directions. Place the turnovers on the greased ceramic enamel tray, then place the tray on the medium rack.	D
7. SNACKS	1	<b>BITE SIZE APPETIZERS</b>	2 servings (8 ea.) 4 servings (16 ea.) (1 serving = 4 ea.)	Preheat the microwave to 375 °F. Place the appetizers on the ceramic enamel tray, then the place tray on the medium rack.	D
	2	<b>QUESADILLA</b>	1 serving (1 ea.) 2 servings (2 ea.) (1 serving = 1 ea.)	Follow the package preparation instructions. Let stand 1-2 minutes before serving.	G
	3	<b>FISH STICKS</b>	2 servings 4 servings (1 serving = 6 Sticks)	Preheat the microwave to 400 °F. Place the fish sticks on the low rack, then place the rack on the ceramic enamel tray.	B
	4	<b>NACHOS 1 SERVING</b>	1 serving	Arrange the tortilla chips uniformly on a microwave safe plate. Sprinkle evenly with cheese. Contents : - 2 cups tortilla chips - 1/3 cup grated cheese	G
	5	<b>EGG ROLLS</b>	2 serving (2 ea.) 4 servings (4 ea.) (1 serving = 1 ea.)	Preheat the microwave to 425 °F. Place the egg rolls on the ceramic enamel tray, then place the tray on the high rack.	E

CATEGORY	Cook No.	FOOD	Amount	Directions	Accessory Type
7. SNACKS	6	<b>POTATO BITES</b>	2 serving (10 ea.) 4 servings (20 ea.) (1 serving = 5 ea.)	Preheat the microwave to 425 °F. Place the potato bites on the ceramic enamel tray, then place the tray on the low rack.	A
	7	<b>SOFT PRETZELS, FROZEN</b>	2 serving (2 ea.) 4 servings (4 ea.) (1 serving = 1 ea.)	Preheat the microwave to 400 °F. Place the pretzels on the middle rack, then place the rack on the ceramic enamel tray.	C
	8	<b>POPCORN</b>	1.5 oz. (43 gram) 3.0 oz. (85 gram) 3.5 oz. (99 grams)	Heat only one microwave popcorn bag at a time. Be careful when removing the heated bag from the microwave and opening the bag as the steam can easily burn.	G
8. MELT/ SOFTEN	1	<b>MELT BUTTER</b>	1 stick(¼ lb.) 2 sticks(½ lb.)	Unwrap the butter and cut the butter stick in half lengthwise. Place the butter on a microwave safe dish and cover with wax paper. Stir well afterwards.	G
	2	<b>SOFTEN BUTTER</b>	1 stick (¼ lb.) 2 sticks (½ lb.)	Remove the butter from the packaging and place on a microwave safe dish.	G
	3	<b>MELT CHOCOLATE</b>	1 cup chips	Place the chocolate chips in a microwave safe dish. When the microwave beeps, stir well and restart the microwave. Unless stirred, the chocolate chips will keep their shape even when the heating time is over.	G
	4	<b>SOFTEN ICE CREAM</b>	1 pint ½ gallon	Remove the lid of the carton. Place the carton in the center of the microwave.	G
	5	<b>SOFTEN CREAM CHEESE</b>	1 package (8 oz.)	Unwrap the cream cheese and place on a microwave safe dish.	G
	6	<b>SOFTEN FROZEN JUICE</b>	1 package (11.5 oz.)	Do not place metal juice cans in the microwave. Remove the plastic lid and place in center of microwave. Stir well afterwards.	G
	7	<b>MELT CHEESE</b>	1 cup	Place the cheese in a microwave safe bowl and cover with wax paper. Stir well afterwards.	G
	8	<b>MELT CARAMEL</b>	11 oz.	Place the caramels in a microwave safe bowl. Stir well afterwards.	G
	9	<b>MELT MARSHMALLOWS</b>	10 oz.	Place the marshmallows in a large microwave safe dish. Stir well afterwards.	G



## USING THE EXPRESS MENU FEATURE

This feature offers a convenient way to heat food that you cook frequently.

1. Place the food on the turntable (glass tray).
2. Dial in the Express Menu direction (counterclockwise).
3. Dial to the food you want to cook.
4. Press **Select** button. (For Reheat Dinner Plate, press the **Start** button.)
5. Dial the amount of food, and then press **Start** button.

COOK NO	FOOD	AMOUNT	REMARK
1	POPCORN	3.5 oz. 3.0 oz. 1.5 oz.	Heat only one microwave popcorn bag at a time. Be careful when removing the heated bag from the microwave and opening the bag as the steam can easily burn.
2	BEVERAGE	½ Cup 1 Cup 2 Cup	Place the beverage in a microwave safe container.
3	BAKED POTATO	2 EA 4 EA (10~13oz./each)	Pierce the potatoes 3 times with a fork. Place the potatoes on the glass turntable with one end of the potato pointing towards the center. After cooking, let the potatoes stand for 3-5 minutes.
4	INSTANT MACARONI AND CHEESE	1 SERVING 2 SERVINGS	Follow the package preparation directions.
5	REHEAT PIZZA SLICES	2 SLICES 4 SLICES	Place the pizza on a microwave safe plate. Do not overlap the slices or cover. Let stand 1-2 minutes before serving.
6	REHEAT DINNER PLATE	1 SERVING	Place the pre-cooked, refrigerated food on a microwave safe plate. Cover the plate with vented plastic wrap or wax paper.
7	REHEAT CASSEROLE	1 TO 4 SERVINGS	Place the refrigerated casserole on a microwave safe plate or bowl. Cover with a lid or vented plastic wrap. Stir well before serving.
8	REHEAT PASTA	1 TO 4 SERVINGS	Place the refrigerated pasta on a microwave safe plate or bowl. Cover with a lid or vented plastic wrap. Stir well before serving.
9	REHEAT SOUP, BROTH	1 TO 4 SERVINGS	Pour the refrigerated soup into a microwave safe bowl. Cover with a lid or vented plastic wrap. Stir well before serving.

## USING THE MICROWAVE SETTING COOKING TIMES & POWER LEVELS

Your microwave allows you to set up to two different cooking stages, each with its own time length and power level. The power level lets you control the heating intensity from Warm to High.

### Power Levels

---

The 10 power levels allow you to choose the optimal power level for your cooking needs.

POWER LEVEL			
1	Warm	6	Simmer
2	Low	7	Medium high
3	Defrost	8	Reheat
4	Medium low	9	Sauté
5	Medium	10	High

### One-stage Cooking

---

For simple one-stage cooking, you only need to set a cooking time. The power level is automatically set at High.

1. Press the **Microwave** button.
2. Use the dial to set a cooking time. You can set a time from 5 second to 90 minutes.
3. If you want to set the power level to something other than High, press the **Select** button, then use the dial to enter a power level.
4. Press the **Start** button to begin cooking. If you want to add or reduce the cooking time, use the dial. You can adjust the cooking time while the microwave is operating.

### Multi-stage Cooking (Maximum of 2 stages)

---

Your oven allows you to set two different cooking stages, each with their own time length and power level. The power level lets you control the heating intensity from Warm through to High.

1. Follow steps 1 and 2 in the “One-Stage Cooking” section above.  
When entering more than one cooking stage, you must set the Power Level for the first cooking stage before entering the cooking time and the Power Level for the second stage.
2. Press the **Select** button.
3. Use the dial to set a second cooking time.
4. Press the **Select** button, then use the dial to set the power level of the second cooking stage.
5. Press the **Start** button to begin cooking.

## BROWN

---

Browning adds texture and taste to your recipe. When browning, use the middle or high rack accessories. Use the middle rack when the height of food is so high that the food could touch the upper heater.

1. Press the **Brown** button. The display shows **SET TIME**.
2. Use the dial to set a cooking time (max time 60 min).
3. Press the **Start** button to begin Browning.
  - The Convection Heater (750W) and Upper Heater (940W) operate at the same time.
  - The vent fan operates at low speed at the same time.

## BAKE / ROAST

---

The Bake/Roast mode uses dry heat to cook and brown food. A high speed fan circulates hot air inside the oven to heat food quickly and evenly. When you cook using convection, you would generally use the low rack. If you are cooking a large amount of food, you can cook using the low and middle racks simultaneously. For best results if you are using both racks, change the location of the food in the middle of cooking.

1. Press the **Bake** or **Roast** button. The display shows: **SET TEMP**
2. Use the dial to set a temperature in the convection cooking range: 100 °F to 425 °F.  
To maintain a constant temperature, keep the oven door closed while the food is cooking. Open as infrequently as possible.
3. Press the **Select** button. If you want to preheat the oven, press the **Start** button.
4. Use the dial to set a cooking time (max time 60 min).
5. Press **Start** button to begin convection cooking.

## SPEED BAKE / ROAST

---

The combination cooking feature allows you to cycle automatically between microwave and Bake/Roast cooking. The food will be moist as well as crisp and brown. This type of cooking is ideal for large foods that require long cooking times when prepared in a conventional oven (such as large roasts, whole chickens, etc.). When combination cooking, use the low or middle rack to allow air to circulate completely around the dish.

To use combination cooking

1. Press the **Speed Bake/Roast** button.
2. Dial Speed Bake or Speed Roast, and then press **Select** button.  
The display shows **SET TIME**.
3. Use the dial to set the cooking time (max time: 60 min.), and then press then **Select** button.  
The display shows **SET POWER**.
4. Use the dial to set the microwave power level (10, 30, 50, 70%, etc.).
5. Press the **Start** button.

This mode combines microwave energy with hot air and therefore reduces the cooking time while giving the food a brown and crispy surface.

### Cookware for cooking with Speed bake/roast

---

Please only use cookware that is specially manufactured for microwave ovens. Do not use metal cookware with this combination mode. Do not use any type of plastic cookware, as it can melt.

### Food suitable for Speed bake/roast

---

Other food suitable for this combination mode cooking include all kinds of previously cooked food which need reheating and browning (e.g. baked pasta), as well as foods which require a short cooking time to brown the top of the food. This mode can also be used for thick food portions that benefit from a browned and crispy top (e.g. chicken pieces, turning them over half way through cooking). Other food suitable for this cooking mode include a variety of meats and poultry as well as frozen snacks and pizza.

## SPEED BAKE/ROAST GUIDE

Use the cooking mode, power levels and times in this table as guide lines for speed cooking. Use oven gloves when taking the food out of the microwave.

Type	Food	Quantity	Mode	Time	Instructions
PIZZA	<b>Frozen Pizza, Individual</b>	6 inch	Speed Bake 30%	10-14	Place the pizza on the medium rack, then place the rack on the ceramic enamel tray.
	<b>Frozen Pizza, Regular</b>	12 inch	Speed Bake 30%	13-18	Place the pizza on the medium rack, then place the rack on the ceramic enamel tray.
MEAT	<b>Beef Roast (medium)</b>	2 – 3 lbs.	1 <sup>st</sup> side Speed Roast 30%  2 <sup>nd</sup> side Roast 325 °F	1 <sup>st</sup> side 25-40  2 <sup>nd</sup> side 25-40	Brush beef/lamb with oil and spice with pepper, salt and paprika. Place the roast on the low rack, then place the rack on the ceramic enamel tray. After cooking, wrap in aluminium foil and let stand for 10–15 minutes
	<b>Steaks</b>	0.5-1.0 lb.	1 <sup>st</sup> side Speed Roast 30%  2 <sup>nd</sup> side Speed Roast 10%	1 <sup>st</sup> side 7-13  2 <sup>nd</sup> side 10-15	Place the steak on the high rack, then place the rack on the ceramic enamel tray. After cooking, let the steak rest for 5 minutes before slicing.
	<b>Pork Tenderloin</b>	0.5-1.0 lb.	1 <sup>st</sup> side Speed Roast 30%  2 <sup>nd</sup> side Speed Roast 10%	1 <sup>st</sup> side 12-18  2 <sup>nd</sup> side 10-16	Place the pork on the low rack, then place the rack on the ceramic enamel tray. After cooking, let the steak rest for 5 minutes before slicing.
	<b>Roast Chicken</b>	3 – 4 lbs.	1 <sup>st</sup> side Speed Roast 50%  2 <sup>nd</sup> side Speed Roast 30%	1 <sup>st</sup> side 25-40  2 <sup>nd</sup> side 15-30	Fold the wings under the chicken. Place the chicken on the low rack, then place the rack on the ceramic enamel tray. Brush the chicken with melted butter/oil and seasonings. 1 <sup>st</sup> Side: Put chicken breast side down. 2 <sup>nd</sup> Side: Put breast side up.
	<b>Bone-in Chicken pieces</b>	2-4 pieces	1 <sup>st</sup> side Speed Roast 50%  2 <sup>nd</sup> side Brown	1 <sup>st</sup> side 12-18  2 <sup>nd</sup> side 10-20	Place the chicken pieces on the high rack, then place the rack on the ceramic enamel tray. 1 <sup>st</sup> Side: Put chicken skin side down. 2 <sup>nd</sup> Side: Put chicken skin side up.
Snack, Frozen	<b>Chicken Nuggets</b>	5-10 ea.	Speed Roast 30%	5-10	Place the chicken nuggets on the ceramic enamel tray, then place the tray on the high rack.
	<b>Chicken Wings</b>	10-20 ea.	Speed Roast 50%	12-17	Place the chicken wings on the low rack, then place the rack on the ceramic enamel tray.
	<b>French Fries</b>	6-12 oz.	Speed Bake 30%	10-15	Place the french fries on the ceramic enamel tray, then place the tray on the medium rack.

# cookware guide

To cook food in the microwave oven, the microwaves must be able to penetrate the food without being reflected or absorbed by the dish.

It is important to choose the correct cookware, therefore look for cookware that is marked microwave-safe.

The following table lists various types of cookware and indicates if and how they should be used in a microwave oven.

## RECOMMENDED COOKING UTENSILS

- **Glass and glass-ceramic bowls and dishes** — Use for heating or cooking.
- **Microwavable plastic wrap** — Use to cover. Leave a small opening for some steam to escape and avoid placing it directly on the food.
- **Wax paper** — Use as a cover to prevent spattering.
- **Paper towels and napkins** — Use for short-term heating and covering. They absorb excess moisture and prevent spattering. Do not use recycled paper towels, which may contain metal and can catch fire.
- **Paper plates and cups** — Use for short-term heating at low temperatures. Do not use recycled paper, which may contain metal and can catch fire.
- **Thermometers** — Use only those labeled “Microwave Safe” and follow all directions. Check the food in several places. Conventional thermometers may be used once the food has been removed from the oven.

## LIMITED USE ITEMS

- **Aluminum foil** — Use narrow strips of foil to prevent overcooking of exposed areas. Using too much foil can damage your oven, so be careful.
- **Ceramic, porcelain, and stoneware** — Use these if they are labeled “Microwave Safe”. If they are not labeled, test them to make sure they can be used safely. Never use dishes with metallic trim.
- **Plastic** — Use only if labeled “Microwave Safe”. Other plastics can melt.
- **Straw, wicker, and wood** — Use only for short-term heating, as they can be flammable.

## NOT RECOMMENDED

- **Glass jars and bottles** — Regular glass is too thin to be used in a microwave and can shatter.
- **Paper bags** — These are a fire hazard, except for popcorn bags that are designed for microwave use.
- **Styrofoam plates and cups** — These can melt and leave an unhealthy residue on food.
- **Plastic storage and food containers** — Containers such as margarine tubs can melt in the microwave.

## TESTING UTENSILS

If you are not sure whether a dish is microwave-safe or not, you can perform this test:

1. Fill a 1 cup glass measuring cup with water and put it inside your oven, next to the dish you want to test.
2. Dial in the **Microwave +30 Sec.** direction (clockwise) and set to 1 minute to heat the glass and dish for one minute at High power. Press the **Start** button to begin.

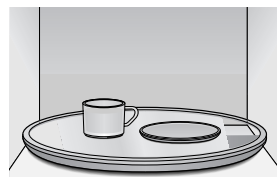

When the microwave stops, the water should be warm and the dish you are testing should be cool. If the dish is warm, then it is absorbing microwave energy and is not acceptable for use in the microwave.

# cooking guide

---

Microwave energy actually penetrates food, attracted and absorbed by the water, fat and sugar content. The microwaves cause the molecules in the food to move rapidly. The rapid movement of these molecules creates friction and the resulting heat cooks the food.

## COOKING TECHNIQUES

---

### Stirring

---

Stir foods such as casseroles and vegetables while cooking to distribute heat evenly. Food at the outside of the dish absorbs more energy and heats more quickly, so stir from the outside to the center. The oven will turn off when you open the door to stir your food.

### Arrangement

---

Arrange unevenly shaped foods, such as chicken pieces or chops, with the thicker, meatier parts toward the outside of the turntable where they receive more microwave energy. To prevent overcooking, place thin or delicate parts toward the center of the turntable.

### Shielding

---

Shield food with narrow strips of aluminum foil to prevent overcooking. Areas that need shielding include poultry wing-tips, the ends of poultry legs, and corners of square baking dishes. Use only small amounts of aluminum foil. Larger amounts can damage your oven.

### Turning

---

Turn foods over midway through cooking to expose all parts to microwave energy. This is especially important with large items such as roasts.

### Standing

---

Foods cooked in the microwave build up internal heat and continue to cook for a few minutes after the oven stops. Let foods stand to complete cooking, especially foods such as roasts and whole vegetables. Roasts need this time to complete cooking in the center without overcooking the outer areas. All liquids, such as soup or hot chocolate, should be shaken or stirred when cooking is complete. Let liquids stand a moment before serving. When heating baby food, stir well and test the temperature before serving.

### Adding Moisture

---

Microwave energy is attracted to water molecules. Food that is uneven in moisture content should be covered or allowed to stand so that the heat disperses evenly. Add a small amount of water to dry food to help it cook.

### Venting

---

After covering a dish with plastic wrap, vent plastic wrap by turning back one corner so excess steam can escape.

## GENERAL MICROWAVE TIPS

---

- Dense foods, such as potatoes, take longer to heat than lighter foods. Foods with a delicate texture should be heated at a low power level to prevent it from becoming tough.
- Altitude and the type of cookware you are using can affect cooking time. When using a new recipe, use the minimum cooking time and check the food occasionally to prevent overcooking.
- Foods with a non-porous skin such as potatoes or hot dogs should be pierced to prevent bursting.
- Frying with heating oil or fat is not recommended. Fat and oil can suddenly boil over and cause severe burns.
- Some ingredients heat faster than others. For example, the jelly inside a jelly doughnut will be hotter than the dough. Keep this in mind to avoid burns.

- Home canning in the microwave oven is not recommended because all harmful bacteria may not be destroyed by the microwave heating process.
- Although microwaves do not heat the cookware, the heat from the food is often transferred to the cookware. Always use pot holders when removing food from the microwave and instruct children to do the same.
- Making candy in the microwave is not recommended as candy can heat to very high temperatures. Keep this in mind to avoid injury.

## **GUIDE FOR COOKING EGGS IN YOUR MICROWAVE**

---

- Never cook eggs in the shell and never warm hard-cooked eggs in the shell. They can explode.
- Always pierce whole eggs to keep them from bursting.
- Cook eggs just until set. They become tough if overcooked.

## **GUIDE FOR COOKING VEGETABLES IN YOUR MICROWAVE**

---

- Vegetables should be washed just before cooking. Often, no extra water is needed. If you are cooking dense vegetables such as cubed potatoes, carrots, or green beans, add about  $\frac{1}{4}$  cup water.
- Small vegetables (sliced carrots, peas, lima beans, etc.) will cook faster than larger ones.
- Whole vegetables, such as potatoes, acorn squash, or corn on the cob, should be arranged in a circle on the turntable before cooking. They will cook more evenly if turned over after half the cooking time.
- Always place vegetables like asparagus and broccoli with the stem ends pointing towards the edge of the dish and the tips toward the center.
- When cooking cut vegetables, always cover the dish with a lid or vented microwavable plastic wrap.
- Whole, unpeeled vegetables such as potatoes, squash, eggplant, etc., should have their skin pricked in several spots before cooking to prevent them from bursting.
- For more even cooking, stir or rearrange whole vegetables halfway through the cooking time.
- Generally, the denser the food, the longer the standing time. (Standing time refers to the time necessary for dense, large foods and vegetables to finish cooking after they come out of the oven.) A baked potato can stand on the counter for five minutes before cooking is completed, while a dish of peas can be served immediately.

# cleaning and maintaining your microwave oven

---

Keeping your microwave oven clean improves its performance, wards off unnecessary repairs, and lengthens its life.

## CLEANING THE EXTERIOR

---

It's best to clean spills on the outside of your microwave oven as they occur. Use a soft cloth and warm, soapy water. Rinse and dry.



Do not get water into the vents. Never use abrasive products or chemical solvents such as ammonia or alcohol as they can damage the appearance of your microwave.



Unplug the microwave plug before cleaning.

## Cleaning under your microwave oven

---

Regularly clean grease and dust from the bottom of your microwave using a solution of warm water and detergent.

## Cleaning the control panel

---

Wipe with a damp cloth and dry thoroughly. Do not use cleaning sprays, large amounts of soap and water, abrasives or sharp objects on the panel as it is easily damaged.

## Cleaning the door and door seals

---

Always ensure that the door seals are clean and that the door closes properly. Take particular care when cleaning the door seals to ensure that no particles accumulate and prevent the door from closing correctly. Wash the glass door with very mild soap and water. Be sure to use a soft cloth to avoid scratching.



If steam accumulates inside or outside the oven door, wipe with a soft cloth. Steam can accumulate when operating the oven at high humidity and in no way indicates microwave leakage.

## CLEANING THE INTERIOR

---



Ensure that the microwave oven has cooled down before cleaning it to avoid injury.



Remove the glass tray from the oven when cleaning the oven or tray.

To prevent the tray from breaking, handle it with care and do not put it in water immediately after cooking. Wash the tray carefully in warm sudsy water or in the dishwasher.

See Steam Clean section on page 18

## CLEANING THE TURNTABLE AND ROLLER RINGS

---

Clean the roller rings periodically and wash the turntable as required. The turntable can safely be washed in your dishwasher.



## STORING AND REPAIRING YOUR MICROWAVE OVEN

If you need to store your microwave oven for a short or extended period of time, choose a dust-free, dry location. Dust and dampness may adversely affect the ability of the microwave parts.



WARNING

Do not repair, replace, or service any part of your microwave oven yourself. Allow only a qualified service technician to perform repairs. If the oven is faulty and needs servicing, or you are in doubt about its condition, unplug the oven from the power outlet and contact your nearest service center.

Do not use the oven if the microwave oven is damaged, in particular if the door or door seals are damaged or the door does not close properly. This can be caused by a broken hinge, a worn out seal or distorted/bent casing.

Do not remove the oven from its casing.

This microwave oven is for home use only and is not intended for commercial use.

## REPLACING THE COOKTOP/NIGHT LIGHT

When replacing the cooktop/night light, make sure that you are wearing gloves to avoid injury from the heat of the bulb.

1. Unplug the oven or turn off the power at the main power supply.
2. Remove the screw from the light cover and lower the cover.
3. Disconnect the wire connector.
4. Remove the screw securing the LED lamp board.
5. Replace the LED lamp board.



To purchase a new LED lamp board, visit an authorized service center or call Samsung Customer Care at 1-800-SAMSUNG (726-7864).

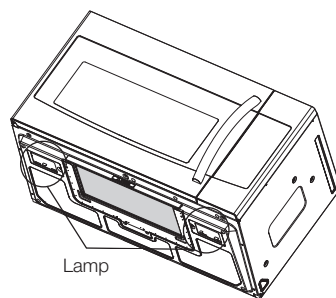

## REPLACING THE OVEN LIGHT

When replacing the oven light, make sure that you are wearing gloves to avoid injury from the heat of the bulb.

1. Unplug the oven or turn off the power at the main power supply.
2. Open the door.
3. Remove the vent cover mounting screws (2 middle screws).
4. Slide the vent grille to the left, then pull it straight out.
5. Remove the charcoal filter, if present.
6. Remove the screw securing the lamp cover.
7. Remove the bulb by pulling it out gently.
8. Replace the bulb with a 20 watt halogen bulb.
9. Replace the bulb holder.
10. Replace the vent grille and the 2 screws.
11. Turn the power back on.

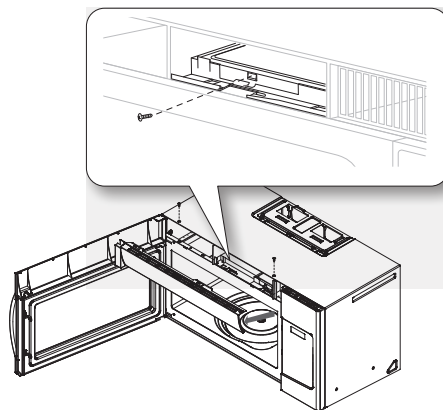

## CLEANING THE GREASE FILTER

Your microwave oven has reusable grease filter. The grease filters should be removed and cleaned at least once a month, or as required.

To order a new grease filter, contact SamsungParts at 1-800-627-4368 or your Samsung dealer.

You can also order online at [www.samsungparts.com](http://www.samsungparts.com)

 **WARNING** To avoid risk of personal injury or property damage, do not operate the oven hood without the filters in place.

1. To remove the filter, push the front of the grease filter case where it says "PUSH".

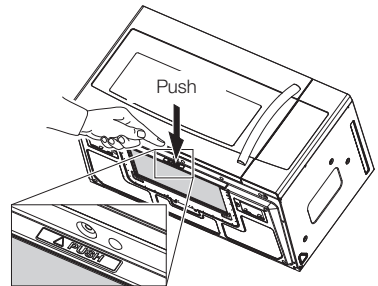

2. Pull the filter case out of the microwave oven.

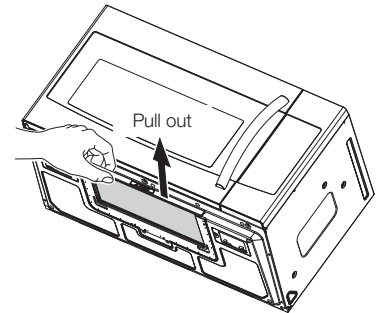

3. Remove the filter from the filter case by widening the case, as shown below. Then, soak the grease filter in hot water mixed with a mild detergent. Rinse well and shake to dry. If necessary, brush the filter lightly to remove embedded dirt. When the filter is dry, put it back in the filter case.

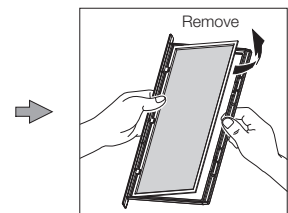
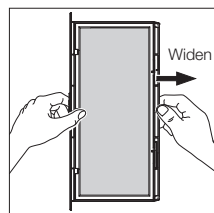

 **WARNING** Do not use ammonia or put the grease filter in the microwave oven. The aluminum will darken.

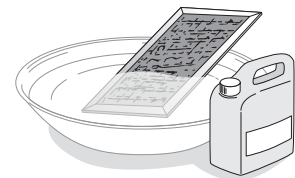

4. To re-insert the filter into the microwave oven, slide the filter case into the frame slot, and then push it inside.

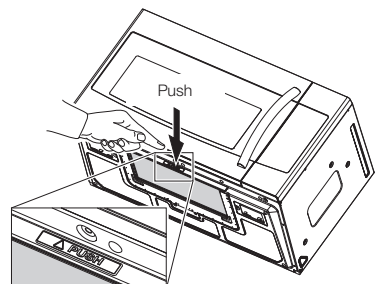

## REPLACING THE CHARCOAL FILTER

If your oven is vented to the inside, the charcoal filter should be replaced every 6 to 12 months and more often if necessary. The charcoal filter cannot be cleaned. To order a new charcoal filter, contact the Parts Department at 1-800-627-4368 or your Samsung dealer. You can also order online at [www.samsungparts.com](http://www.samsungparts.com)

1. Unplug the oven or turn off the power at the main power supply.
2. Open the door.
3. Remove the vent grille mounting screws (2 middle screws).
4. Slide the vent grille to the left, then pull it straight out.
5. Push the hook and remove the old filter.

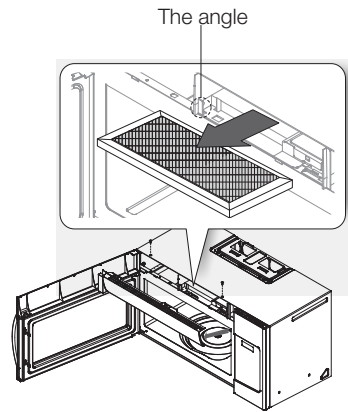

6. Slide a new charcoal filter into place. The filter should rest at the angle shown.
7. Replace the vent grille and 2 screws and close the door. Turn the power back on and set the clock.

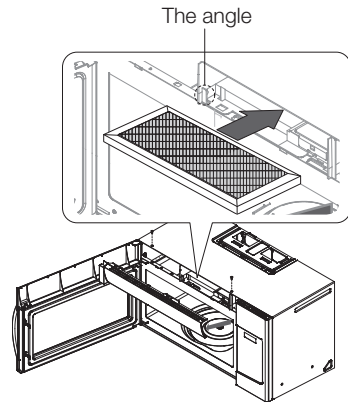

# troubleshooting

---

## CHECK THESE POINTS IF YOUR MICROWAVE OVEN

---

<b>PROBLEM</b>	<b>SOLUTION</b>
<b>The display and/or the oven is not working.</b>	Make sure the plug is properly connected to a grounded outlet. If the wall outlet is controlled by a wall switch, make sure the wall switch is turned on. Remove the plug from the outlet, wait ten seconds, and plug it in again. Reset the circuit breaker or replace any blown fuses. Plug a different appliance into the outlet. If the other appliance doesn't work, call a qualified electrician to repair the wall outlet. Plug the oven into a different outlet.
<b>The display is working, but the power won't come on.</b>	Make sure the door is closed securely. Check if any packaging material or anything else is stuck in the door seal. Check if the door is damaged. Touch Cancel twice and enter all the cooking instructions again.
<b>The power goes off before the set time has elapsed.</b>	If there was a power outage, the time indicator will display: 88:88. If no power outage occurred, remove the plug from the outlet, wait ten seconds, and plug it in again. Reset the clock and any cooking instructions. Reset the circuit breaker or replace any blown fuses.
<b>Cooks food too slowly.</b>	Make sure the oven has its own 20 amp circuit line. Operating another appliance on the same circuit can cause a voltage drop. If necessary, move the oven to its own circuit.
<b>Has sparks or arcing.</b>	Remove any metallic utensils, cookware, or metal ties. If using foil, use only narrow strips and allow at least one inch between the foil and the interior oven walls.
<b>The turntable makes noise or becomes stuck.</b>	Clean the turntable, roller ring and oven floor. Make sure the turntable and roller ring are positioned correctly.
<b>Causes TV or radio interference.</b>	This is similar to interference caused by other small appliances, such as hair dryers. Move your microwave (or appliance) away from appliances, such as your TV or radio.

# appendix

## SPECIFICATIONS

<b>MODEL NUMBER</b>	<b>MC17F808KDT</b>
Oven Cavity	1.7 cuft
Controls	10 power levels, including defrost
Timer	90 minutes
Power Source	120 VAC, 60 Hz
Power Consumption	1700 Watt Microwave / 1750 Watt Heater
Microwave Power Output	950 Watts
Cook Top Light	3.6W LED lamp(1.8 X 2EA)
Oven Light	20 Watts halogen lamp
Oven Cavity Dimensions	20 1/8"(W) X 10 5/16"(H) X 14"(D)
Outside Dimensions	29 7/8"(W) X 16 15/16"(H) X 17 9/16"(D)
Shipping Dimensions	33 3/8"(W) X 20 3/16"(H) X 19 7/16"(D)
Net/Shipping Weight	76.7 / 86.6 LBS

# warranty

## WARRANTY AND SERVICE INFORMATION

To help us to serve you better, please complete the enclosed registration card and promptly return it by mail. If the registration card is missing, you can call Samsung Electronics, Inc., at

**1-800-SAMSUNG (726-7864) or register online at [www.samsung.com/global/register](http://www.samsung.com/global/register).**

When contacting Samsung, please provide the specific model and serial number information which is usually located on the back or bottom of the product. Please record these numbers below, along with the other requested information. Keep this information in a safe place as a permanent record of your purchase to aid in identification in case of theft or loss along with a copy of your sales receipt as a proof of purchase if warranty service is needed.

**MODEL NUMBER** \_\_\_\_\_

**SERIAL NUMBER** \_\_\_\_\_

**DATE PURCHASED** \_\_\_\_\_

**PURCHASED FROM** \_\_\_\_\_

Warranty service can only be performed by a Samsung Authorized Service Center. If you should require warranty service, provide the above information with a copy of your sales receipt to the Samsung Authorized Service Center.

For service assistance and the location of the nearest service center, please call **1-800- SAMSUNG (1-800-726-7864)**.

# warranty

---

## **SAMSUNG OVER-THE-RANGE (OTR) MICROWAVE OVEN**

---

### **Limited warranty to original purchaser**

This SAMSUNG brand product, as supplied and distributed by Samsung Electronics America, Inc. (SAMSUNG) and delivered new, in the original carton to the original consumer purchaser, is warranted by SAMSUNG against manufacturing defects in materials and workmanship for a limited warranty period of:

### **ONE (1) YEAR PARTS AND LABOR, TEN (10) YEARS PARTS WARRANTY FOR MAGNETRON**

This limited warranty begins on the original date of purchase, and is valid only on products purchased and used in the United States. To receive warranty service, the purchaser must contact SAMSUNG for problem determination and service procedures. Warranty service can only be performed by a SAMSUNG authorized service center. The original dated bill of sale must be presented upon request as proof of purchase to SAMSUNG or SAMSUNG's authorized service center.

SAMSUNG will repair this product or replace it if cannot repair it, at our option and at no charge as stipulated herein, with new or reconditioned parts or products if found to be defective during the limited warranty period specified above. All replaced parts and products become the property of SAMSUNG and must be returned to SAMSUNG. Replacement parts and products assume the remaining original warranty, or ninety (90) days, whichever is longer.

In-home service will be provided during the warranty labor period subject to availability within the contiguous United States. In-home service is not available in all areas. To receive in-home service, the product must be unobstructed and accessible to service personnel. If during in-home service repair can not be completed, it may be necessary to remove, repair and return the product. If in-home service is unavailable, SAMSUNG may elect, at our option, to provide for transportation of our choice to and from a SAMSUNG authorized service center. Otherwise, transportation to and from the SAMSUNG authorized service center is the responsibility of the purchaser.

This limited warranty covers manufacturing defects in materials and workmanship encountered in normal, noncommercial use of this product and shall not apply to the following, including, but not limited to: damage which occurs in shipment; delivery and installation; applications and uses for which this product was not intended; altered product or serial numbers; cosmetic damage or exterior finish; accidents, abuse, neglect, fire, water, lightning or other acts of nature; use of products, equipment, systems, utilities, services, parts, supplies, accessories, applications, installations, repairs, external wiring or connectors not supplied or authorized by SAMSUNG which damage this product or result in service problems; incorrect electrical line voltage, fluctuations and surges; customer adjustments and failure to follow operating instructions, cleaning, maintenance and environmental instructions that are covered and prescribed in the instruction book; problems caused by pest infestations, and overheating or overcooking by user; glass tray or turntable; reduced magnetron power output related to normal aging. SAMSUNG does not warrant uninterrupted or error-free operation of the product.

THERE ARE NO EXPRESS WARRANTIES OTHER THAN THOSE LISTED AND DESCRIBED ABOVE, AND NO WARRANTIES WHETHER EXPRESS OR IMPLIED, INCLUDING, BUT NOT LIMITED TO, ANY IMPLIED WARRANTIES OF MERCHANTABILITY OR FITNESS FOR A PARTICULAR PURPOSE, SHALL APPLY AFTER THE EXPRESS WARRANTY PERIODS STATED ABOVE, AND NO OTHER EXPRESS WARRANTY OR GUARANTY GIVEN BY ANY PERSON, FIRM OR CORPORATION WITH RESPECT TO THIS PRODUCT SHALL BE BINDING ON SAMSUNG. SAMSUNG SHALL NOT BE LIABLE FOR LOSS OF REVENUE OR PROFITS, FAILURE TO REALIZE SAVINGS OR OTHER BENEFITS, OR ANY OTHER SPECIAL, INCIDENTAL OR CONSEQUENTIAL DAMAGES CAUSED BY THE USE, MISUSE OR INABILITY TO USE THIS PRODUCT, REGARDLESS OF THE LEGAL THEORY ON WHICH THE CLAIM IS BASED, AND EVEN IF SAMSUNG HAS BEEN ADVISED OF THE POSSIBILITY OF SUCH DAMAGES. NOR SHALL RECOVERY OF ANY KIND AGAINST SAMSUNG BE GREATER IN AMOUNT THAN THE PURCHASE PRICE OF THE PRODUCT SOLD BY SAMSUNG AND CAUSING THE ALLEGED DAMAGE. WITHOUT LIMITING THE FOREGOING, PURCHASER ASSUMES ALL RISK AND LIABILITY FOR LOSS, DAMAGE OR INJURY TO PURCHASER AND PURCHASER'S PROPERTY AND TO OTHERS AND THEIR PROPERTY ARISING OUT OF THE USE, MISUSE OR INABILITY TO USE THIS PRODUCT SOLD BY SAMSUNG NOT CAUSED DIRECTLY BY THE NEGLIGENCE OF SAMSUNG. THIS LIMITED WARRANTY SHALL NOT EXTEND TO ANYONE OTHER THAN THE ORIGINAL PURCHASER OF THIS PRODUCT, IS NONTRANSFERABLE AND STATES YOUR EXCLUSIVE REMEDY.

Some states do not allow limitations on how long an implied warranty lasts, or the exclusion or limitation of incidental or consequential damages, so the above limitations or exclusions may not apply to you. This warranty gives you specific legal rights, and you may also have other rights which vary from state to state.

To obtain warranty service, please contact SAMSUNG at:

**1-800-SAMSUNG (1-800-726-7864) or [www.samsung.com](http://www.samsung.com)**

memo

---

# SAMSUNG



Scan the QR code\* or visit [www.samsung.com/spsn](http://www.samsung.com/spsn) to view our helpful How-to Videos and Live Shows

\*Requires reader to be installed on your smartphone

Scan this with your smartphone

Please be advised that the Samsung warranty does NOT cover service calls to explain product operation, correct improper installation, or perform normal cleaning or maintenance.

## QUESTIONS OR COMMENTS?

COUNTRY	CALL	OR VISIT US ONLINE AT
U.S.A Consumer Electronics	1-800-SAMSUNG (726-7864)	<a href="http://www.samsung.com/us/support">www.samsung.com/us/support</a>
CANADA	1-800-SAMSUNG (726-7864)	<a href="http://www.samsung.com/ca/support">www.samsung.com/ca/support</a> (English) <a href="http://www.samsung.com/ca_fr/support">www.samsung.com/ca_fr/support</a> (French)