

**SAMSUNG**

**HW-K950**

# User manual

Imagine the possibilities

Thank you for purchasing this Samsung product.  
To receive more complete service, please register your product at  
[www.samsung.com/register](http://www.samsung.com/register)



# SAFETY INFORMATION







- The following also applies to the Wireless Subwoofer (PS-KW1-1) and Surround Speakers (PS-KS2-1, PS-KS2-2).

## SAFETY WARNINGS

TO REDUCE THE RISK OF ELECTRIC SHOCK, DO NOT REMOVE THE COVER (OR BACK).  
NO USER-SERVICEABLE PARTS ARE INSIDE. REFER SERVICING TO QUALIFIED SERVICE PERSONNEL.

 <div style="background-color: black; color: white; padding: 5px; text-align: center; font-weight: bold;">CAUTION</div> <div style="background-color: black; color: white; padding: 2px; text-align: center; font-weight: bold; font-size: small;">RISK OF ELECTRIC SHOCK. DO NOT OPEN.</div> 		This symbol indicates that high voltage is present inside. It is dangerous to make any kind of contact with any internal part of this product.
		This symbol indicates that this product comes with important literature concerning operation and maintenance.

	Class II product : This symbol indicates that a safety connection to electrical earth (ground) is not required.
	AC voltage : Rated voltage marked with this symbol is AC voltage
	DC voltage : Rated voltage marked with this symbol is DC voltage.
	Caution. Consult instructions for use : This symbol instructs the user to consult the user manual for further safety related information.

### WARNING

- To reduce the risk of fire or electric shock, do not expose this apparatus to rain or moisture.
- To prevent injury, this apparatus must be securely attached to the floor/wall in accordance with the installation instructions.
- This product contains chemicals known to the State of California to cause cancer and birth defects or other reproductive harm.

### CAUTION

- Do not expose this apparatus to dripping or splashing. Do not put objects filled with liquids, such as vases on the apparatus.
- To turn this apparatus off completely, you must pull the power plug out of the wall socket. Consequently, the power plug must be easily and readily accessible at all times.

**FCC NOTE (for U.S.A):****Class B FCC Statement**

The included module(s) has been tested and found to comply with the limits for a Class B digital device, pursuant to Part 15 of the FCC Rules. These limits are designed to provide reasonable protection against harmful interference in a residential installation. This equipment generates, uses and can radiate radio frequency energy and, if not installed and used in accordance with the instructions, may cause harmful interference to radio communications. However, there is no guarantee that interference will not occur in a particular installation. If this equipment does cause harmful interference to radio or television reception, which can be determined by turning the equipment off and on, the user is encouraged to try to correct the interference by one of the following measures:

- Reorienting or relocating the receiving antenna.
- Increasing the separation between the equipment and receiver.
- Connecting the equipment to an outlet that is on a different circuit than the radio or TV.
- Consulting the dealer or an experienced radio/TV technician for help.

**FCC Radiation Exposure Statement :**

This equipment complies with FCC radiation exposure limits set forth for an uncontrolled environment.

This equipment should be installed and operated so there is at least 8 inches (20 cm) between the radiator and your body. This device and its antenna(s) must not be co-located or operated in conjunction with any other antenna or transmitter.

**FCC Caution :**

- Any changes or modifications not expressly approved by the party responsible for compliance could void the user's authority to operate this equipment. This device complies with Part 15 of the FCC Rules. Operation is subject to the following two conditions: (1) This device may not cause harmful interference, and (2) this device must accept any interference received, including interference that may cause undesired operation.
- This product satisfies FCC regulations when shielded cables and connectors are used to connect the unit to other equipment. To prevent electromagnetic interference with electric appliances, such as radios and televisions, use shielded cables and connectors for connections.

**Important Safety Instructions**

Read these operating instructions carefully before using the unit. Follow all the safety instructions listed below. Keep these operating instructions handy for future reference.

- 1) Read these instructions.
- 2) Keep these Instructions.
- 3) Heed all warnings.
- 4) Follow all instructions.
- 5) Do not use this apparatus near water.
- 6) Clean only with dry cloth.

- 7) Do not block any ventilation openings. Install in accordance with the manufacturer's instructions.
- 8) Do not install near any heat sources such as radiators, heat registers, stoves, or other apparatus (including amplifiers) that produce heat.
- 9) Do not defeat the safety purpose of the polarized or grounding-type plug. A polarized plug has two blades with one wider than the other. A grounding type plug has two blades and a third grounding prong. The wide blade or the third prong are provided for your safety. If the provided plug does not fit into your outlet, consult an electrician for replacement of the obsolete outlet.
- 10) Protect the power cord from being walked on or pinched particularly at plugs, convenience receptacles, and the point where they exit from the apparatus.
- 11) Only use attachments/accessories specified by the manufacturer.
- 12) Use only with the cart, stand, tripod, bracket, or table specified by the manufacturer, or sold with the apparatus. When a cart is used, use caution when moving the cart/apparatus combination to avoid injury from tip-over.
- 13) Unplug this apparatus during lightning storms or when unused for long periods of time.
- 14) Refer all servicing to qualified service personnel. Servicing is required when the apparatus has been damaged in any way, such as power-supply cord or plug is damaged, liquid has been spilled or objects have fallen into the apparatus, the apparatus has been exposed to rain or moisture, does not operate normally, or has been dropped.

**LICENSES**

Manufactured under license from Dolby Laboratories. Dolby, Dolby Atmos, Dolby Audio, Dolby Digital Plus, Pro Logic, and the double-D symbol are trademarks of Dolby Laboratories.



For DTS patents, see <http://patents.dts.com>. Manufactured under license from DTS Licensing Limited. DTS, the Symbol, DTS in combination with the Symbol, and DTS Digital Surround are registered trademarks or trademarks of DTS, Inc. in the United States and/or other countries. © DTS, Inc. All Rights Reserved.



The terms HDMI and HDMI High-Definition Multimedia Interface, and the HDMI Logo are trademarks or registered trademarks of HDMI Licensing LLC in the United States and other countries.

## PRECAUTIONS

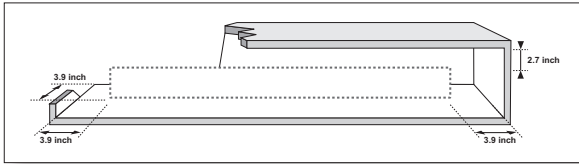

Ensure that the AC power supply in your house complies with the power requirements listed on the identification sticker located on the back of your product. Install your product horizontally, on a suitable base (furniture), with enough space around it for ventilation (3-4 inches). Make sure the ventilation slots are not covered. Do not place the unit on amplifiers or other equipment which may become hot. This unit is designed for continuous use. To fully turn off the unit, disconnect the AC plug from the wall outlet. Unplug the unit if you intend to leave it unused for a long period of time.

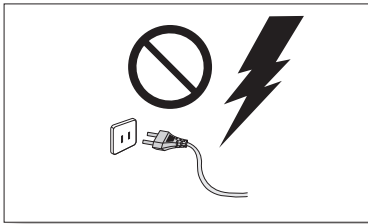

During thunderstorms, disconnect the AC plug from the wall outlet. Voltage peaks due to lightning could damage the unit.

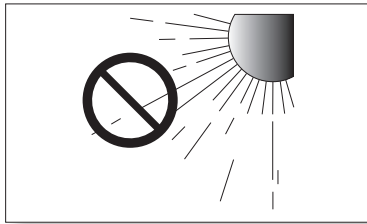

Do not expose the unit to direct sunlight or other heat sources. This could lead to overheating and cause the unit to malfunction.

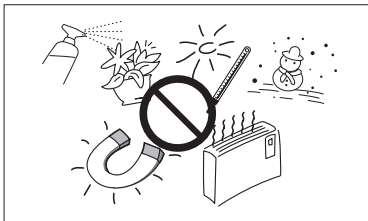

Protect the product from moisture (i.e. vases), and excess heat (e.g. a fireplace) or equipment creating strong magnetic or electric fields. Unplug the power cable from the AC wall socket if the unit malfunctions. Your product is not intended for industrial use. It is for personal use only. Condensation may occur if your product has been stored in cold temperatures. If transporting the unit during the winter, wait approximately 2 hours until the unit has reached room temperature before using.

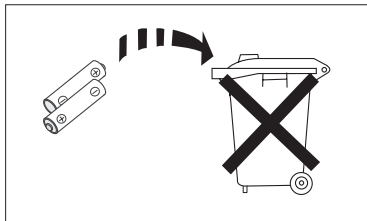

The batteries used with this product contain chemicals that are harmful to the environment. Do not dispose of the battery in the general household trash. Do not expose the battery to excess heat, direct sunlight, or fire. Do not short circuit, disassemble, or overheat the battery. Danger of explosion if the battery is replaced incorrectly. Replace only with the same or equivalent type.



# DOLBY ATMOS®

This product supports Dolby Atmos®.



## \* What is Dolby Atmos®?

Atmos technology enhances existing 5.1 channel surround sound systems by adding an overhead speaker. This envelops the listener in 360 degrees of sound, delivering an immersive, high-definition, rich, detailed, and deeper experience. See page 25 to learn how to connect the system.

# CONTENTS

## **2 GETTING STARTED**

- 2 Safety Information
- 5 Dolby Atmos®
- 7 What's Included

## **8 DESCRIPTIONS**

- 8 Front / Right Side Panel
- 9 Bottom Panel
- 10 Remote Control

## **15 INSTALLATION**

- 15 Installing the Soundbar
  - 15 Installing the Wall Mount
  - 18 Detaching the Soundbar from the Wall
- 19 Installing the Surround Speakers on a Wall

## **20 CONNECTIONS**

- 20 Connecting the Subwoofer and Surround Speakers
- 23 Connecting to a TV
  - 23 Connecting to a TV Using an HDMI (Digital) Cable
  - 24 Connecting to a TV Using a Digital Optical Cable
- 25 Connecting to External Devices
  - 25 Connecting Devices in Order to Use Dolby Atmos®
  - 26 HDMI Cable
  - 26 Optical or Analog Audio Cable

## **27 FUNCTIONS**

- 27 Input Mode
- 28 Bluetooth
- 30 Using the Multiroom App
- 32 Using the Network Standby On Function
- 33 Software Update

## **35 TROUBLESHOOTING**

- 35 Troubleshooting

## **36 APPENDIX**

- 36 Specifications



Figures and illustrations in this User Manual are provided for reference only and may differ from actual product appearance.

# WHAT'S INCLUDED

## BEFORE READING THE USER'S MANUAL

Note the following terms before reading the user manual.

### ► Icons used in this manual

Icon	Term	Definition
	<b>Caution</b>	Indicates a situation where a function does not operate or settings may be canceled.
	<b>Note</b>	Indicates tips or instructions on the page that help you operate a function.

Check for the supplied accessories shown below.



**Remote Control /  
Batteries (AA Size)**  
(AH59-02745A / 4301-000101)



**Power Cord : 3 EA**  
(3903-001117)

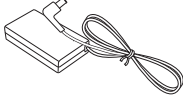

**AC/DC Adapter  
(for main unit)**  
(BN44-00887A)



**HDMI Cable**  
(BN39-01583C)



**Wall Mount Guide**  
( AH63-04424A)



**Holder-Screw : 2 EA**  
(AH61-04110A)



**Screw : 2 EA**  
(6003-001334)



**Bracket-Wall Mount : 2 EA**  
(AH61-04119A)



- The appearance of the accessories may differ slightly from the illustrations above.
- To distinguish the left surround speaker from the right, check the label on the rear of each speaker.
- Depending on the region, the AC plug may vary in appearance, or it may be supplied integrated with the adapter

# FRONT / RIGHT SIDE PANEL

## 1 - / + (Volume) Button

Controls the volume level.

The numeric value of the volume level appears in the front panel display.

## 2 (Source) Button

Selects the D.IN, AUX, HDMI1, HDMI2, or BT input.

- To turn on **BT PAIRING** mode, press and hold this button in BT mode.

## 3 (Power) Button

Turns the power on and off.

Right Side

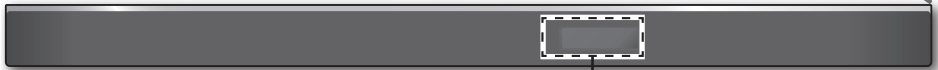
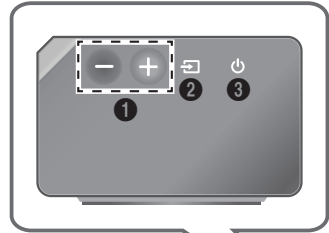

Display ■

Displays the current mode.



- When you plug in the AC cord, the power button will begin working in 4 to 6 seconds. When you press the power button, there will be a 20 second delay before the unit produces sound.
- When you turn on this unit, there will be a 4 to 5 second delay before it produces sound.
- If you want to enjoy sound only from the Soundbar, you must turn off the TV's speakers in the Audio Setup menu of your TV. Refer to the owner's manual supplied with your TV.

# BOTTOM PANEL

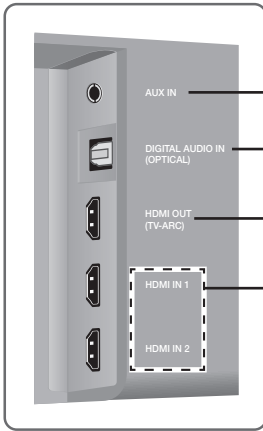

**AUX IN**

Connect to the Analog output of an external device.

**DIGITAL AUDIO IN (OPTICAL)**

Connect to the digital (optical) output of an external device.

**HDMI OUT (TV-ARC)**

Outputs digital video and audio signals simultaneously using an HDMI cable.

**HDMI IN 1, HDMI IN 2**

Inputs digital video and audio signals simultaneously using an HDMI cable. Use when connecting a supported external device.



**LABEL**

**Wi-Fi SETUP**

Press this button to connect your Soundbar to your network using Wi-Fi setup. (Requires a smart device and the Samsung Multiroom app. See page 30.)

**SPK ADD**

Press this button to connect the Soundbar to a Samsung HUB (purchased separately) or a network. (Requires a smart device and the Samsung Multiroom app. See page 30.)

**DC 19V (Power Supply In)**

Connect the AC/DC power adaptor to the power supply jack, and then connect the AC/DC power adaptor plug to a wall outlet.

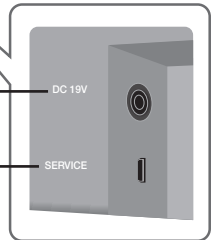

**SERVICE**

USB micro jack. To upgrade the product's software. Requires a USB adapter. (Sold separately.) See page 33.



- When disconnecting the power cable of the AC power adaptor from a wall outlet, pull the plug. Do not pull the cable.
- Do not connect this unit or other components to an AC outlet until all connections between components are complete.

# REMOTE CONTROL

**Power**  
Turns the Soundbar on and off.

**(Ⓞ) SOUND**  
Surround Sound adds depth and spaciousness to the sound. Pressing the **(Ⓞ) SOUND** button repeatedly cycles through the Surround Sound settings :  
**ON - SURROUND SOUND, OFF - SURROUND SOUND**

- ON: Play sound over all the speakers.
- OFF: Play sound through the original source channel.

**Up/Down/Left/Right**  
Press the indicated areas to select Up/Down/Left/Right. Press Up/Down/Left/Right on the button to select or set functions.

You can also activate the **Wi-Fi SETUP** function by pressing and holding the **Up** button on the remote for more than 5 seconds.

You can also activate the **SPK ADD** function of the Soundbar by pressing and holding the **Down** button of the remote for more than 5 seconds.

**Music Skip**  
Press the **Right** button to select the next music; press the **Left** button to select the previous music.

**Anynet+**  
Press and hold the **Right** button for about 5 seconds to turn the Anynet+ function on or off.  
(Default : **ON - ANYNET+** or **OFF - ANYNET+**)  
The Anynet+ function lets you control the Soundbar with the remote from an Anynet+ compatible Samsung TV.  
The Soundbar must be connected to the TV via an HDMI cable.

**Auto Power Link**  
Press and hold the **Left** button for about 5 seconds to turn the Auto Power Link function on or off.  
(Default : **OFF - POWER LINK** or **ON - POWER LINK**)  
Synchronizes the Soundbar to a connected Optical source via the Optical jack so it turns on automatically when you turn on your TV. (See page 24)  
The Auto Power Link function is only available in the **D.IN** mode.

**EFFECT**  
You can select from 6 sound modes - **STANDARD (Original Sound), MUSIC, CLEAR VOICE, SPORTS, MOVIE,** and **NIGHT** - depending on the content you want to listen to.

Select the **STANDARD** mode if you want to enjoy the original sound.

**\* DRC (Dynamic Range Control)**  
Lets you apply dynamic range control to Dolby Digital tracks.  
Press and hold the **EFFECT** button for about 5 seconds in standby mode to toggle the DRC (Dynamic Range Control) function  
**ON - DRC** and **OFF - DRC.**

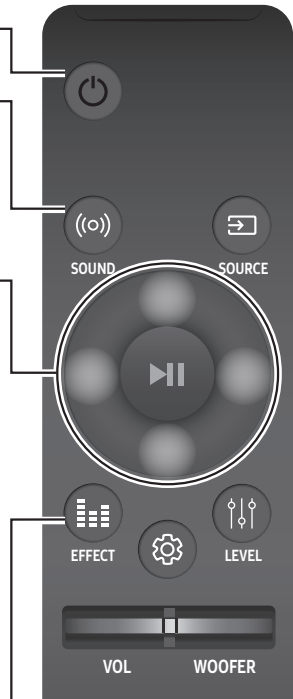

- Operate the TV using the TV's remote control.

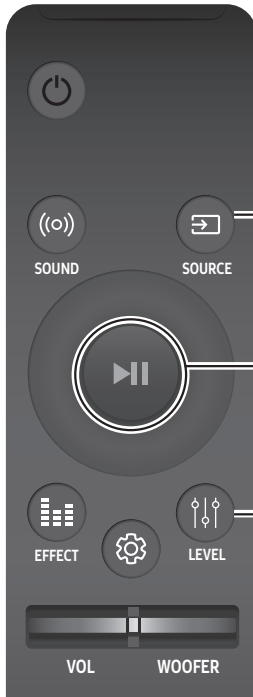

**SOURCE**

Press to select a source connected to the Soundbar.

**\* BT PAIRING mode**

To turn on BT PAIRING mode in Bluetooth function, press and hold the **SOURCE** button for more than 5 seconds.

**Play / Pause (BT / WIFI)**

Press the **▶||** button to pause a music temporarily.  
Press the **▶||** button again to play the selected music.

**LEVEL**

The ATMOS Soundbar has 5.1.4 channel sound. Use this button to adjust the volume of each of the speakers. Press this button, use the **Left/Right** buttons to select a speaker, and then use the **Up/Down** buttons to increase or decrease the level (volume).

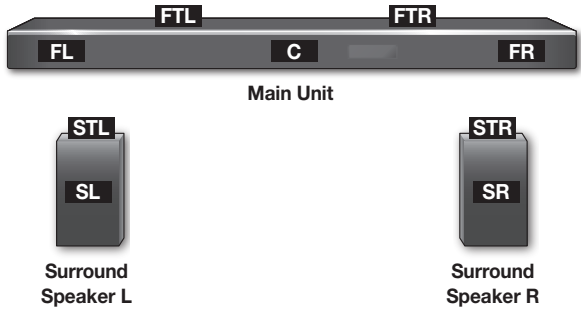

Speaker		Displayed on OLED when adjusting the level
Main Unit	Front Left	FL
	Front Top Left	FTL
	Center	C
	Front Right	FR
	Front Top Right	FTR
Surround Speaker L	Surround Left	SL
	Surround Top Left	STL
Surround Speaker R	Surround Right	SR
	Surround Top Right	STR

**\* Network Standby On/Off**

Press and hold the **LEVEL** button for about 5 seconds to turn the Network Standby on or off. (See page 32)



**⚙️ (Sound Control)**

Press to select **TREBLE**, **BASS**, or **AUDIO SYNC**. Then, use the **Up/Down** buttons to adjust the **TREBLE** or **BASS** volume from -3 ~ +3.

Press and hold the ⚙️ **(Sound Control)** button for about 5 seconds to adjust the sound for each frequency band. 150Hz, 300Hz, 600Hz, 1.2KHz, 2.5KHz, 5KHz, and 10KHz are selectable (**Left/Right**) and each can be adjusted to a setting between -6 ~ +6 (**Up/Down**).

If the Soundbar is connected to a digital TV and the video appears out of sync with the audio, press the ⚙️ **(Sound Control)** button to sync the audio with the video. Use the **Up/Down** buttons to set the audio delay between 0 ms ~ 300 ms. In BT mode, the Audio Sync function may not be available.

**WOOFER**

Push the button up or down to adjust the volume of the subwoofer to -12 or -6 to +6.

Pressing the button reverses the subwoofer volume to level 0.



**VOL**

Push the button up or down to adjust the volume.

**Mute**

Press the **VOL** button to mute the sound. Press it again to unmute the sound.



► **Controlling the Volume of Soundbar by using Your TV Remote Control**

1. Press and hold the ((⊙)) **SOUND** button for more than 5 seconds while the Soundbar is turned on.
2. "ON - TV REMOTE" appears on the Soundbar's display.
3. In the TV's menu, set the TV speaker to external speaker.



- Not available in **TV ARC**, **BT**, **HDMI1** and **HDMI2** modes. (Available only in **D.IN** (optical) and **AUX** modes)
- On the TV remote control, only the volume and mute buttons are available. Other buttons are disabled.
- TV menus differ by manufacturer and model. Refer to the TV's user manual for further information.
- Manufacturers supporting this function:
  - VIZIO, LG, Sony, Sharp, PHILIPS, PANASONIC, TOSHIBA, GRUNDIG, Hisense, RCA
  - This function may not be compatible with your TV's remote depending on the remote control's manufacturer.
- To turn off this function, press the ((⊙)) **SOUND** button for 5 seconds. "OFF - TV REMOTE" appears on the Soundbar's display.



## INSERTING BATTERIES (AA BATTERY X2)

Slide the battery cover in the direction of the arrow until it is completely removed.  
 Insert 2 AA batteries (1.5V) in the correct +/- polarity. Slide the battery cover back into position.

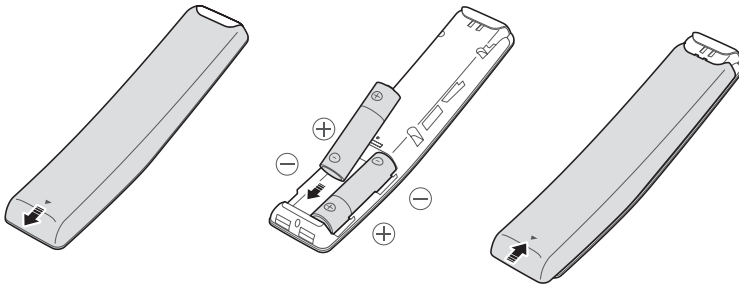

## USING THE HIDDEN BUTTONS

Hidden Button		Reference page
Remote Control Button	Function	
<b>(⦿) SOUND</b>	TV remote control On/Off	Page 12
<b>SOURCE</b>	BT Paring	Page 28
<b>▶   (Play / Pause)</b>	Auto Power Down On/Off (AUX mode)	Page 27
<b>VOL</b>	ID SET	Page 21
<b>Up</b>	WIFI SETUP	Page 10
<b>Down</b>	ADD SPEAKER	Page 10
<b>Left</b>	Auto Power Link On/Off	Page 24
<b>Right</b>	Anynet+ On/Off	Page 10
<b>⚙️ (Sound Control)</b>	7 Band EQ	Page 12
<b>EFFECT</b>	DRC On/Off	Page 10
<b>LEVEL</b>	Network Standby On/Off	Page 32

## OUTPUT SPECIFICATIONS FOR THE DIFFERENT MODES OF SOUND EFFECT

Input	Effect		Output
2 ch	 SOUND	ON	5.1.4 ch
5.1 ch			5.1.4 ch
2 ch	 EFFECT	STANDARD	2.1 ch
5.1 ch			5.1 ch
2 ch	 EFFECT	MUSIC	2.1 ch
5.1 ch			5.1 ch
2 ch	 EFFECT	CLEAR VOICE	3.1 ch
5.1 ch			5.1 ch
2 ch	 EFFECT	SPORTS	5.1.4 ch
5.1 ch			5.1.4 ch
2 ch	 EFFECT	MOVIE	5.1.4 ch
5.1 ch			5.1.4 ch
2 ch	 EFFECT	NIGHT	3.1 ch
5.1 ch			5.1 ch

\* If the input source is Dolby Atmos®, 5.1.4 channel is outputted. The sound effect is not available.

# INSTALLING THE SOUNDBAR

## INSTALLING THE WALL MOUNT

### ► Installation Precautions

- Install on a vertical wall only.
- For the installation, avoid a location with high temperature or humidity, or a wall that cannot sustain the weight of the set.
- Check the strength of the wall. If the wall is not strong enough to support the unit, reinforce the wall or install the unit on a different wall that can support the unit's weight.
- Purchase and use the fixing screws or anchors appropriate for the kind of wall you have (plaster board, iron board, wood, etc.). If possible, fix the support screws into wall studs.
- Purchase wall mounting screws according to the type and thickness of the wall you will mount the Soundbar on.
  - Diameter: M5
  - Length: 1 3/8 inches or longer recommended.
- Connect cables from the unit to external devices before you install it on the wall.
- Make sure the unit is turned off and unplugged before you install it. Otherwise, it may cause an electric shock.

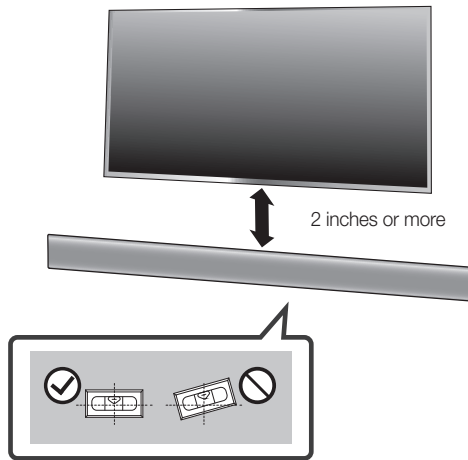

1. Place the **Wall Mount Guide** against the wall surface.
  - The **Wall Mount Guide** must be level.
  - If your TV is mounted on the wall, install the Soundbar at least 2 inches (5 cm) below the TV.

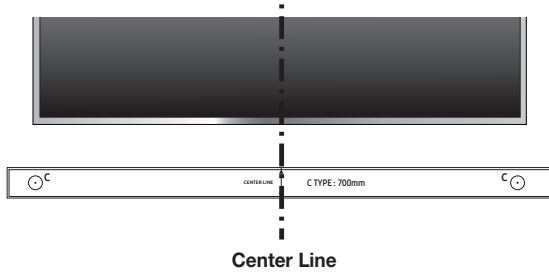

2. Align the Paper Template's **Center Line** with the center of your TV (if you are mounting the Soundbar below your TV), and then fix the **Wall Mount Guide** to the wall using tape.



- If you are not mounting below a TV, place the **Center Line** in the center of the installation area.

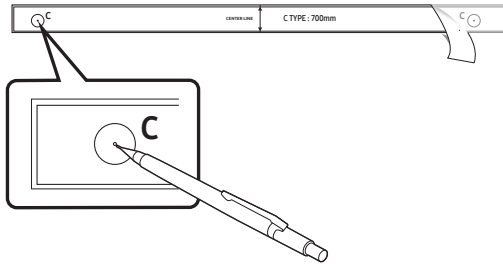

3. Push a pen tip or sharpened pencil tip through the center of the **C-TYPE** images on each end of the Guide to mark the holes for the supporting screws, and then remove the **Wall Mount Guide**.
4. Using an appropriately sized drill bit, drill a hole in the wall at each marking.



- If the markings do not correspond to the positions of studs, make sure you insert appropriate anchors or mollies into the holes before you insert the support screws. If you use anchors or mollies, make sure the holes you drill are large enough for the anchors or mollies you use.

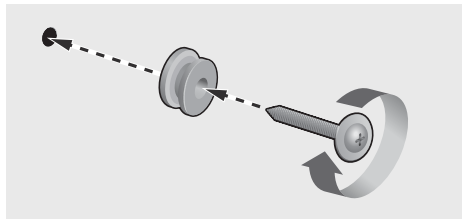

5. Push a screw (not supplied) through each **Holder-Screw**, and then screw each screw firmly into a support screw hole.

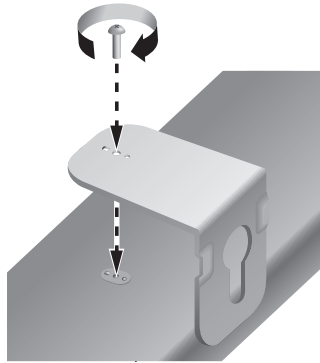

6. Install 2 **Bracket-Wall Mounts** in the right orientation on the bottom of the Soundbar, using 2 **Screws** (M4 x L12).

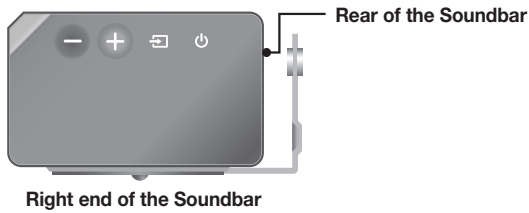

- When assembling, make sure the hanger parts of the **Bracket-Wall Mounts** are located behind the rear of the Soundbar. See the illustration above.

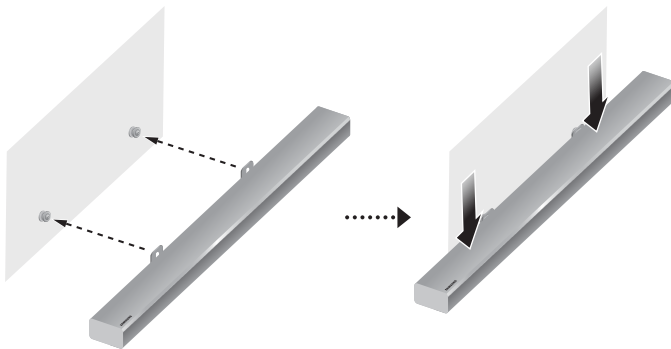

7. Install the Soundbar with the attached **Bracket-Wall Mounts** by hanging the **Bracket-Wall Mounts** on the **Holder-Screws** on the wall.

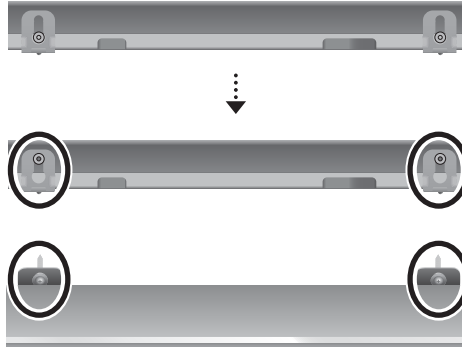

8. Slide the Soundbar down as shown above so that the **Bracket-Wall Mounts** rest securely on the **Holder-Screws**.



- Slide the **Bracket-Wall Mounts** down from the bottom to install it onto the **Holder-Screws**.

## DETACHING THE SOUNDBAR FROM THE WALL

1. To separate the Soundbar from the wall mount, push it in the direction of arrow.

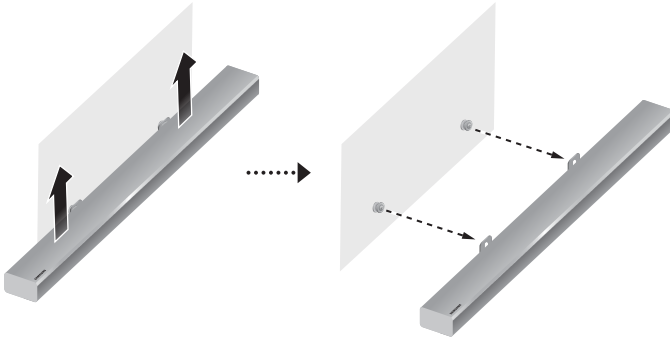

- Do not hang onto the installed unit and avoid striking or dropping the unit.
- Secure the unit firmly to the wall so that it does not fall off. If the unit falls off, it may cause an injury or damage the product.
- When the unit is installed on a wall, please make sure that children do not pull any of the connecting cables, as this may cause it to fall.
- For the optimal performance of a wall mount installation, install the speaker system at least 2 inches (5 cm) below the TV, if the TV is mounted on the wall.
- For your safety, if you do not mount the unit on the wall, install it on a secure, flat surface where it is unlikely to fall.

# INSTALLING THE SURROUND SPEAKERS ON A WALL

You can purchase wall mounts separately to install the surround speakers on a wall.

## ► Considerations for purchasing

- Endurable load : Above 17.6 lbs (8.0 Kg)
- Hole size : 1/4 - 20 threaded insert



- Since wall mount installation is optional, you must purchase the corresponding accessories separately.
  - Please have a qualified installer install the surround speaker Wall Mount Brackets.
  - Ask a professional installation company to mount your product on the wall.
  - Check the strength of the wall before you install the Wall Mount Brackets. If the strength is insufficient, make sure to reinforce the wall before installing the Wall Mount Brackets and the speakers on the wall.
  - For more information, please refer to the Wall Mount's manual.
  - Samsung Electronics is not liable for any damage to the product due to the product being installed inappropriately.
  - Take care not to install the speakers sideways or upside down.
-

# CONNECTING THE SUBWOOFER AND SURROUND SPEAKERS

You can enjoy rich bass tones and better sound quality by linking the subwoofer to the main unit.



- Do not connect the power cord of this product or your TV to a wall outlet until all connections between components are complete.
- Before moving or installing this product, be sure to turn off the power and disconnect the power cord.
- If the main unit is powered off, the wireless subwoofer and surround speaker will go into stand-by mode and the STANDBY LED on the rear will be Red after blinking Blue several times.
- If you use a device that uses the same frequency (2.4GHz) as the Soundbar near the Soundbar, interference may cause some sound interruption.
- The maximum transmission distance of the wireless signal of the main unit is about 32.8 ft, but may vary depending on your operating environment. If a steel-concrete or metallic wall is between the main unit and the wireless subwoofer or surround speaker, the system may not operate at all, because the wireless signal cannot penetrate metal.



- Wireless receiving antennas are built into the wireless subwoofer and surround speakers. Keep the units away from water and moisture.
- For optimal listening performance, make sure that the area around the wireless subwoofer and surround speakers location is clear of any obstructions.

## Recommended Speaker Layout

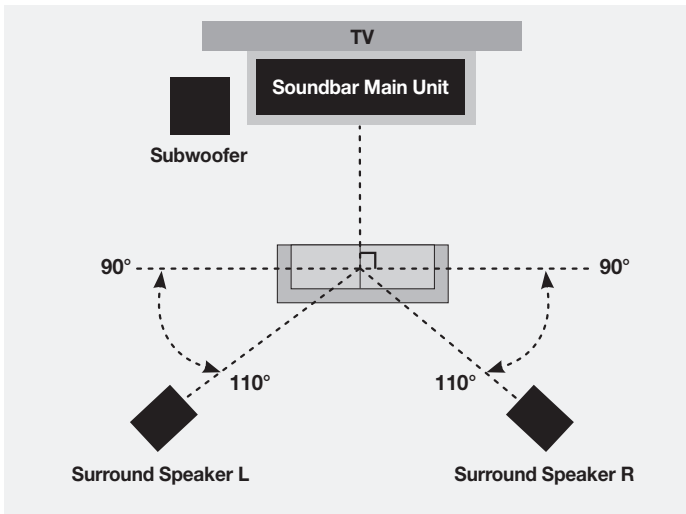



## AUTOMATIC CONNECTION

1. Connect a power supply to the subwoofer and surround sound speakers.
2. Connect a power supply to the Soundbar, and then press the  button on the remote control or on the right side of the Soundbar.
3. The subwoofer and surround sound speakers are automatically connected to the Soundbar.
4. When auto pairing is complete, the blue indicators at the rear of the subwoofer and surround speakers turn on.



- If the red indicator at the rear of the subwoofer or surround speakers is on or the blue indicator flashes continuously, auto pairing cannot occur. If this happens, connect each of the speakers manually, as shown on the next page.
- You can enjoy better sound from the wireless subwoofer by selecting a Sound Effect. (See page 10.)
- Important: Before you begin, put the batteries into the remote. See page 13 for instructions.



Rear of Subwoofer

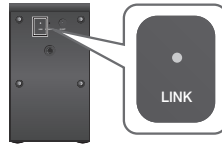

Rear of Surround Speaker

## CONNECTING THE SUBWOOFER AND SURROUND SPEAKERS MANUALLY IF THE AUTOMATIC CONNECTION FAILS

### ► Before You Begin

- Make sure that the Soundbar, the subwoofer, and the surround speakers are plugged in.
  - Make sure that the Soundbar is turned on.
1. Press and hold **ID SET** on the rear of the subwoofer and surround speakers for at least 5 seconds. The red indicator at the rear of each speaker turns off and the blue indicator blinks.

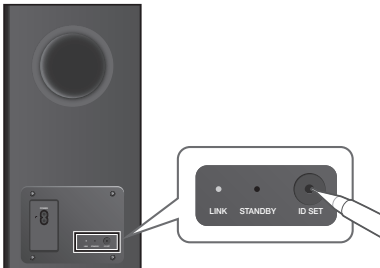

Rear of Subwoofer

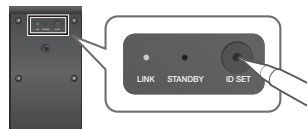

Rear of the Left and Right Surround Speakers

## CONNECTIONS

- Turn off the Soundbar.
- Press and hold the **VOL** button on the remote control for at least 5 seconds with the Soundbar turned off (OFF).



- The ID SET message appears on the display of the Soundbar for a short period of time, and then disappears.

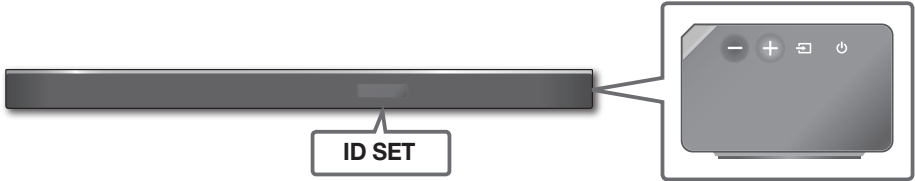

**Right Side of the Soundbar**

- When the blue indicators on the subwoofer and surround sound speakers blink, turn on the power by pressing  button on the right side of the main unit or on the remote control.
- When the connection is successfully established, the blue indicators on the rear of the subwoofer and surround speakers turn on without blinking.



- If the connection process fails, the blue indicators will flash continuously. Go to Step 1 and start again.

## LED INDICATOR LAMP STATUS ON SUBWOOFER AND SURROUND SOUND SPEAKERS

LED	Status	Description	Resolution
Red	On	Standby (with the Soundbar main unit turned off)	Check the power supply to the Soundbar main unit
		Connection failed	Connect again (refer to the instructions on manual connection in the user manual)
Blue	On	Successfully connected (normal operation)	-
	Blinking	Standby (with the Soundbar main unit turned off)	Check the power supply to the Soundbar main unit
		Connection failed	Connect again (refer to the instructions on manual connection in the user manual)
Red and blue	Blinking	Malfunction	Contact the service center.

# CONNECTING TO A TV



- Important: Before you begin, put the batteries into the remote. See page 13 for instructions.

## CONNECTING TO A TV USING AN HDMI (DIGITAL) CABLE

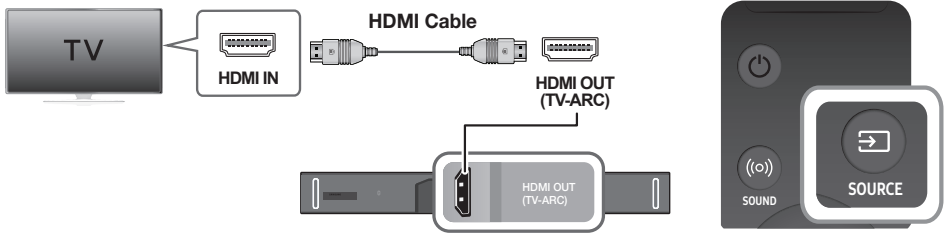



1. Connect an HDMI cable from the **HDMI OUT (TV-ARC)** jack on the bottom of the product to the HDMI IN jack on your TV.
2. Press the  button on the right side of the Soundbar or the **SOURCE** button on the remote control to select the **D.IN** mode.

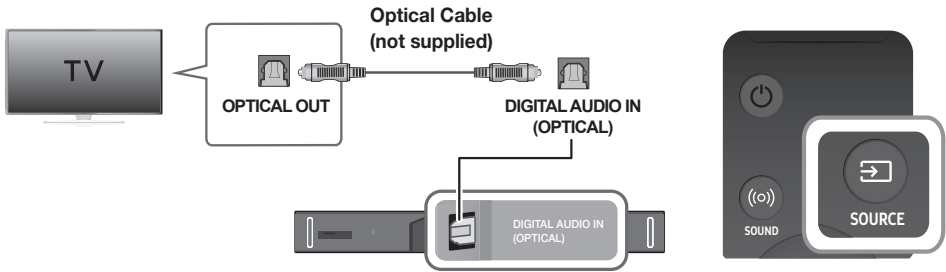

- HDMI is an interface that enables the digital transmission of video and audio data with just a single connector.
- If the TV provides an ARC port, connect the HDMI cable to the HDMI IN (ARC) port.
- We recommend you use a coreless HDMI cable if possible. If you use a cored HDMI cable, use one whose diameter is less than 0.55 inches.
- Anynet+ must be turned on.
- This function is not available if the HDMI cable does not support ARC.

## CONNECTING TO A TV USING A DIGITAL OPTICAL CABLE



1. Connect the **DIGITAL AUDIO IN (OPTICAL)** (Audio) jack on the Soundbar to the **OPTICAL OUT** jack of the TV with a digital optical cable (not supplied).
2. Press the  button on the right side of the Soundbar or the **SOURCE** button on the remote control to select the **D.IN** mode.

### ► Auto Power Link

If you have connected the main unit to a TV with a digital optical cable, you can set the Auto Power function ON to have the Soundbar turn on automatically when you turn the TV on.

1. Connect the Soundbar and a TV with a digital optical cable (not supplied).
2. Press the  button on the main unit's right side or the **SOURCE** button on the remote control to select the **D.IN** mode.
3. Press the **Left** button on the remote control for 5 seconds to turn Auto Power Link on or off.



- Auto Power Link is set to ON by default.
- Depending on the connected device, Auto Power Link may not function.
- This function is only available in the D.IN mode.

# CONNECTING TO EXTERNAL DEVICES

HDMI is the standard digital interface for connecting to TVs, projectors, DVD players, Blu-ray players, set top boxes, and more.

HDMI prevents any degradation to the signal due to conversion to analog and maintains the video and audio quality of the original digital source.

## CONNECTING DEVICES IN ORDER TO USE DOLBY ATMOS®

This product supports Dolby Atmos®.



- Important: Dolby Atmos® is available only in HDMI mode.

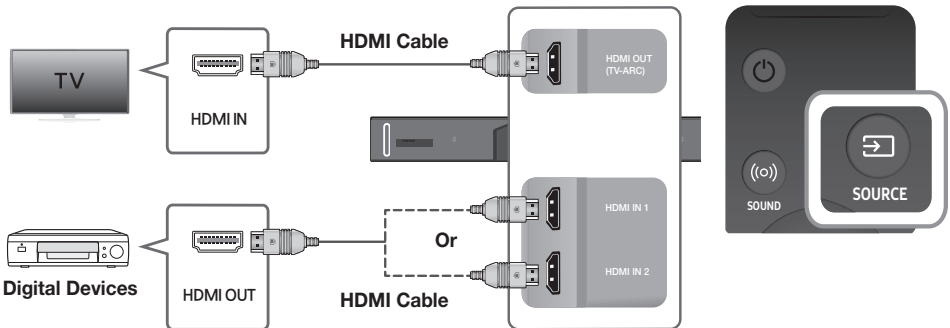

1. Connect an HDMI cable from the **HDMI IN 1** or **HDMI IN 2** jack on the back of the product to the HDMI OUT jack on your digital device.
2. Press the button on the right side of the Soundbar or the **SOURCE** button on the remote control to select the **HDMI1** or **HDMI2** mode.
3. The selected HDMI mode is displayed on the Soundbar display panel and sound plays.



- When Dolby Atmos® operated, the Blue LED on the right edge of the Soundbar will turn on and glow.

### 4. Configuring Dolby Atmos® on your BD player, or other device.

- Check the audio output options using the settings menu on your BD player, or other device.
- Make sure that "No Encoding" is selected for bitstream in the audio output options.  
e.g., On a Samsung Player: Home menu → Settings → Sound → Digital Output: Select Bitstream (unprocessed).
- If the Audio Output options include Secondary Audio, make sure it is set to Off.



- Dolby Atmos® works only in HDMI mode. It is not compatible with other input sources.
- Dolby Atmos® works only on 5.1.4 channels.
- Make sure that the content supports Dolby Atmos®.

## HDMI CABLE

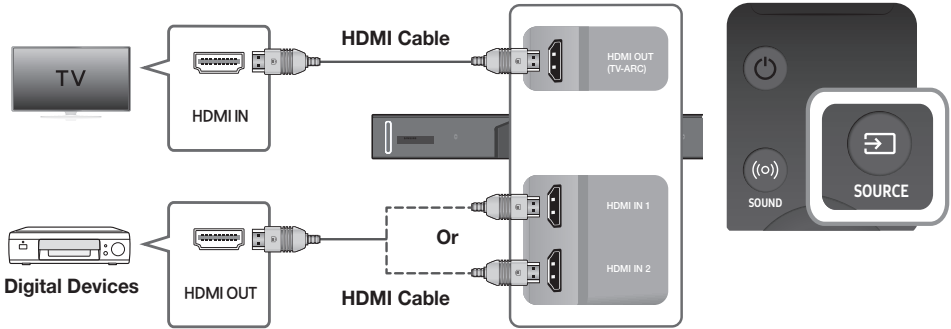

1. Connect an HDMI cable from the **HDMI IN 1** or **HDMI IN 2** jack on the back of the product to the HDMI OUT jack on your digital device.
2. Press the  button on the right side of the Soundbar or the **SOURCE** button on the remote control to select the **HDMI1** or **HDMI2** mode.
3. The selected HDMI mode is displayed on the Soundbar display panel and sound plays.

## OPTICAL OR ANALOG AUDIO CABLE

This unit comes equipped with one digital optical in jack and one analog audio (AUX) in jack, giving you two ways to connect it to external devices.

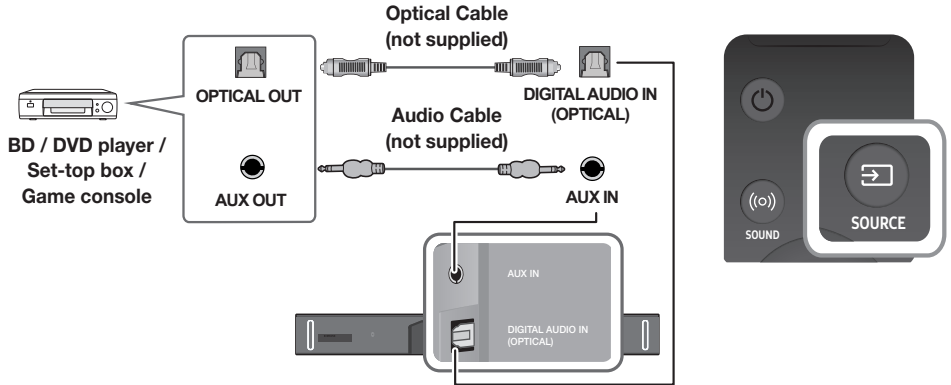

### ► AUX Cable

1. Connect **AUX IN** (Audio) on the main unit to the AUDIO OUT jack of the Source Device using an audio cable.
2. Press the  button on the right side of the Soundbar or the **SOURCE** button on the remote control to select the **AUX** mode.

### ► Optical Cable

1. Connect **DIGITAL AUDIO IN (OPTICAL)** (Audio) on the main unit to the OPTICAL OUT jack of the Source Device using a digital optical cable.
2. Press the  button on the right side of the Soundbar or the **SOURCE** button on the remote control to select the **D.IN** mode.

# INPUT MODE

Press the  button on the main unit's right side or the **SOURCE** button on the remote control to select the mode you want.



Right Side of the Soundbar



Input mode	Display
Optical Digital input ARC (HDMI OUT) input	<b>D.IN</b>
AUX input	<b>AUX</b>
HDMI input	<b>HDMI1, HDMI2</b>
BLUETOOTH mode	<b>BT</b>

## AUTO POWER DOWN FUNCTION

The unit turns off automatically in the following situations.

- D.IN / BT Mode
  - If there is no audio signal for 5 minutes.
- HDMI1 / HDMI2 Mode
  - If there is no audio signal for 15 minutes.
- AUX Mode
  - If the AUX cable is disconnected for 5 minutes.
  - If there is no KEY input for 8 hours when the AUX cable is connected. (Auto Power Down function can be turned off only in that case.)

To turn off Auto Power Down function, while in **AUX** mode, press and hold the  button for 5 seconds.

**ON - AUTO POWER DOWN / OFF - AUTO POWER DOWN** appears on the display.



# BLUETOOTH

You can connect a Bluetooth device to the Soundbar and enjoy music with stereo sound, all without wires!

## TO CONNECT THE SOUNDBAR TO A BLUETOOTH DEVICE

Check if the Bluetooth device supports the Bluetooth compliant stereo headset function.



- Press the  button on the main unit's right side or the **SOURCE** button on the remote control to select the **BT** mode.
  - You will see **BT READY** or **BT PAIRING** on the front display of the Soundbar.
- Select the Bluetooth menu on the Bluetooth device you want to connect. (Refer to the Bluetooth device's user manual.)
- Select "**[AV] Samsung Soundbar Kxxx**" from the list.
  - When the Soundbar is connected to the Bluetooth device, it will display **[Bluetooth device name] → BT** on the front display.
  - The device name can only be displayed in English. An underline " \_ " will be displayed if the name is not in English.
  - If the Bluetooth device has failed to pair with the Soundbar, delete the previous "**[AV] Samsung Soundbar Kxxx**" found by the Bluetooth device, switch to **BT PAIRING** mode by pressing and holding the  button on the main unit's right side or the **SOURCE** button on the remote control, and then have the Bluetooth device search for the Soundbar again.
- Play music on the connected device.
  - You can listen to the music playing on the connected Bluetooth device over the Soundbar.
  - In **BT** mode, the Play / Pause / Next / Prev functions are not available. However, these functions are available on Bluetooth devices supporting AVRCP.



- If asked for a PIN code when connecting a Bluetooth device, enter <0000>.
- Only one Bluetooth device can be paired at a time.
- The Bluetooth connection will be terminated when you turn the Soundbar off.
- The Soundbar may not perform Bluetooth search or connection correctly under the following circumstances:
  - If there is a strong electrical field around the Soundbar.
  - If several Bluetooth devices are simultaneously paired with the Soundbar.
  - If the Bluetooth device is turned off, not in place, or malfunctions.
- Note that such devices as microwave ovens, wireless LAN adaptors, fluorescent lights, and gas stoves use the same frequency range as the Bluetooth device, which can cause electric interference.



- The Soundbar supports SBC data (44.1kHz, 48kHz).
- Connect only to a Bluetooth device that supports the A2DP (AV) function.
- You cannot connect the Soundbar to a Bluetooth device that supports only the HF (Hands Free) function.
- Once you have paired the Soundbar to a Bluetooth device, selecting "[AV] Samsung Soundbar Kxxx" from the device's scanned devices list will automatically change the Soundbar to **BT** mode.
  - Available only if the Soundbar is listed among the Bluetooth device's paired devices. (The Bluetooth device and the Soundbar must have been previously paired at least once.)
- Soundbar will appear in the Bluetooth device's searched devices list only when the Soundbar is displaying **BT PAIRING**.

## TO DISCONNECT A BLUETOOTH DEVICE FROM THE SOUNDBAR

You can disconnect a Bluetooth device from the Soundbar. For instructions, see the Bluetooth device's user manual.

- The Soundbar will be disconnected.
- When the Soundbar is disconnected from the Bluetooth device, the Soundbar will display **BT DISCONNECTED** on the front display.

## TO DISCONNECT THE SOUNDBAR FROM A BLUETOOTH DEVICE

Press the **SOURCE** button on the remote control or the  button on the product's right side to switch from **BT** to another mode or turn off the Soundbar.

- The connected Bluetooth device will wait a certain amount of time for a response from the Soundbar before terminating the connection. (Disconnection time may differ, depending on the Bluetooth device)



- In Bluetooth connection mode, the Bluetooth connection will be lost if the distance between the Soundbar and the Bluetooth device exceeds 32.8 ft.
- The Soundbar automatically turns off after 5 minutes in the Ready state.

### ► More About Bluetooth

Bluetooth is a technology that enables Bluetooth-compliant devices to interconnect easily with each other using a short wireless connection.

- A Bluetooth device may cause noise or malfunction, depending on usage, if:
  - A part of your body is in contact with the receiving/transmitting system of the Bluetooth device or the Soundbar.
  - It is subject to electrical variation from obstructions caused by a wall, corner, or office partition.
  - It is exposed to electrical interference from same frequency-band devices including medical equipment, microwave ovens, and wireless LANs.
- Pair the Soundbar with the Bluetooth device while they are close together.
- The further the distance between the Soundbar and Bluetooth device, the worse the quality is. If the distance exceeds the Bluetooth operational range, the connection is lost.
- In poor reception areas, the Bluetooth connection may not work properly.
- The Bluetooth connection only works when it is close to the unit. The connection will be automatically cut off if the Bluetooth device is out of range. Even within range, the sound quality may be degraded by obstacles such as walls or doors.
- This wireless device may cause electric interference during its operation.

# USING THE MULTIROOM APP

The Samsung Multiroom app lets you connect the Soundbar to a smart device, your network, and the Internet. Once the Soundbar is connected to a smart device that has the Multiroom App installed, you can also connect the Soundbar and multiple Samsung Multiroom devices together wirelessly and play audio through them.

## BEFORE YOU BEGIN

### ► Communication Basics

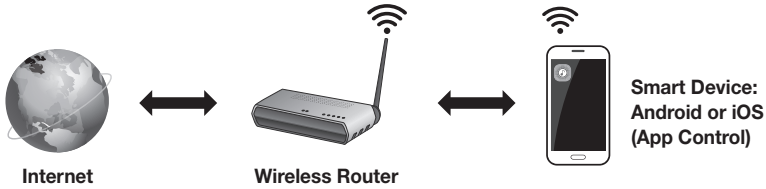

#### Requirements:

1. A Wireless Router and a Smart Device.
2. The wireless router must be connected to the Internet.
3. The smart device must be connected to the router via a Wi-Fi connection.

## INSTALLING THE SAMSUNG MULTIROOM APP

To use the Soundbar with the Samsung Multiroom App, you must download and then install the Samsung Multiroom App on your smart device. You can download the app from Google Play or the App Store. With the Samsung Multiroom App installed, you can play music on your Soundbar that is stored on your smart device, located on other connected devices, provided by other content providers, or streamed from Internet radio stations.

### ► Android or iOS

Download the Samsung Multiroom app from Google Play or the App Store of your smart device.

\* Market search : Samsung Multiroom



or



### ► Launching the Samsung Multiroom App

To launch the Samsung Multiroom app, tap the Multiroom app icon on your smart device.

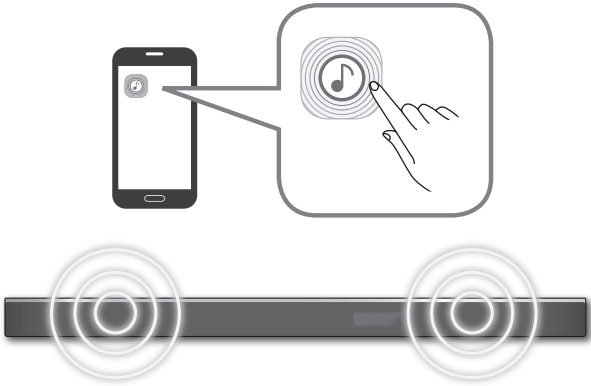

## CONNECTING THE SOUNDBAR TO YOUR NETWORK

On your smart device, select the Samsung Multiroom app. Follow the directions on your smart device's screen. You can use the following music sources with the Samsung Multiroom app.

- Music files stored in your mobile phone, various music sources, and Internet radio.

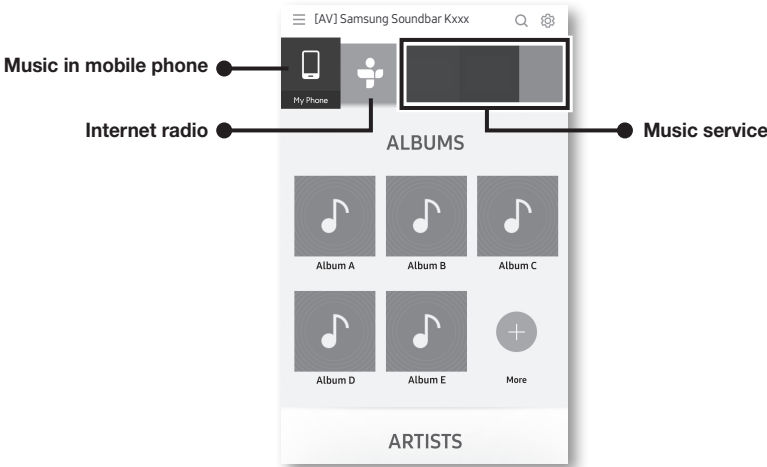

# USING THE NETWORK STANDBY ON FUNCTION

The Network Standby On function becomes available if a wireless connection has been properly established between a smart device and the Soundbar. This function turns on the Soundbar automatically when a smart device attempts to connect to the Soundbar via Bluetooth or Wi-Fi. If you turn the Soundbar on via a Bluetooth connection, its input mode is set to BT automatically. To turn the Soundbar on via Wi-Fi, you must have the Samsung Multiroom App installed on your smart device.

1. Connect the smart device to your Soundbar.
2. Turn on the Network Standby On function by pressing the **LEVEL** button on the Soundbar's remote for more than 5 seconds. You can turn the function off by pressing the **LEVEL** button again for more than 5 seconds.



- Network Standby On is available only if the Soundbar is listed among the smart device's paired devices. (The Smart device and the Soundbar must have been previously paired at least once.)
  - Soundbar will appear in the smart device's searched devices list only when the Soundbar is displaying [BT READY] or [WiFi READY].
  - If the Network Standby On function did not work:
    - The Network Standby On is set to Off. Set it to ON.
  - The Wi-Fi connection to the Soundbar will be terminated if the Soundbar's power cord is disconnected or the power is cut off. If the power is cut off, turn on the Soundbar and reconnect it.
-

# SOFTWARE UPDATE

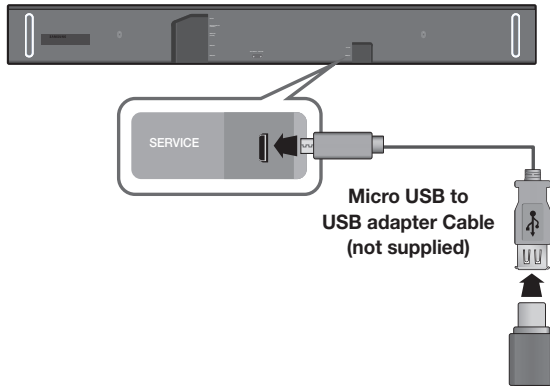

## UPDATING WITH USB

Samsung may offer updates for the Soundbar's system firmware in the future.

If an update is offered, you can update the firmware by connecting a USB device with the firmware update stored on it to the USB port on your Soundbar.

Note that if there are multiple update files, you must load them onto the USB device singly and use them to update the firmware one file at a time.

Please visit [samsung.com](http://samsung.com) or contact the Samsung call center to receive more information about downloading update files.

### ► Updating Procedure

1. Connect a Micro USB to USB adapter cable with a male USB 2.0 Micro USB plug (Type B) on one end and a standard female 2.0 USB jack (Type A) on the other end to the micro USB jack on your Soundbar.



- The Micro USB to USB adapter cable is sold separately. To purchase, contact a Samsung Service Center or Samsung Customer Care.

2. Follow the steps below to download the product software:  
Go to the Samsung website at ([samsung.com/sec](http://samsung.com/sec)) → search for the model name - select the customer support option (the option name is subject to change)
3. Save the downloaded software to a USB stick and select "Extract to the folder name" to unzip the folder.
4. Turn off the Soundbar and connect the USB stick containing the software update to the female port on a Micro USB adapter cable.
5. Turn on the Soundbar. Within 3 minutes, **UPDATE** is displayed and updating begins.
6. After the update is complete, the Soundbar turns off and on again.



- If the input source has been changed after an update or a reconnection of the power cable, change the input source to TV, or the desired source.

### ► If UPDATE is not displayed

1. Turn off the Soundbar, disconnect and then reconnect the USB storage device that contains the update files to the Soundbar's USB port.
2. Disconnect the Soundbar's power cord, reconnect it, and then turn on the Soundbar.



- Insert a USB device containing the firmware update into the USB port on the main unit.
  - Updating firmware may not work properly if audio files supported by the Soundbar are stored in the USB storage device.
  - Do not disconnect the power or remove the USB device while updates are being applied. The main unit will turn off automatically after completing the firmware update.
  - After update is completed, the user setup in Soundbar is initialized. We recommend you write down your settings so that you can easily reset them after the update. Note that updating firmware resets the subwoofer connection too.  
If the connection to the subwoofer is not re-established automatically after the update, refer to page 20.  
If the software update fails, check that the USB stick is not defective.
  - Mac OS users should use MS-DOS (FAT) as the USB format.
  - Depending on the manufacturer, some USB devices may not be supported.
- 

## AUTO UPDATE

If the Soundbar is connected to the Internet, it will automatically check for the latest firmware and update when new firmware becomes available, even if it is turned off.



- The Soundbar is configured to run Auto Update by default.
  - To use the Auto Update function, the Soundbar must be connected to the Internet.
  - The Wi-Fi connection to the Soundbar will be terminated if its power cord is disconnected or the power is cut off. If the power is cut off, turn on the Soundbar and reconnect it.
-

# TROUBLESHOOTING

Refer to the table below if this product does not function properly. If the problem you are experiencing is not listed below or if the instructions below do not help, turn off the product, disconnect the power cord, and contact Samsung Electronics at 1-800-SAMSUNG (1-800-726-7864).

## The unit will not turn on.

- |  |   |
|--|---|
| • Is the power cord plugged into the outlet? | → Connect the power plug to the outlet. |
|--|---|

## A function does not work when the button is pressed.

- |   |   |
|---|---|
| • Is there static electricity in the air? | → Disconnect the power plug and connect it again. |
|---|---|

## Sound is not produced.

- |                                 |  |
|---------------------------------|--|
| • Is the Mute function on?      | → Press the <b>VOL</b> button to cancel the Mute function. |
| • Is the volume set to minimum? | → Adjust the volume.                                       |

## The remote control does not work.

- |   |                               |
|---|-------------------------------|
| • Are the batteries drained?  | → Replace with new batteries. |
| • Is the distance between the remote control and main unit too far? | → Move closer to the unit.    |

## The red LED on the subwoofer blinks and the subwoofer is not producing sound.

- |  |   |
|--|---|
| • Your subwoofer may not be connected to the main unit of the product. | → Try to connect your subwoofer again.<br>(See Page 20) |
|--|---|

## The subwoofer drones and vibrates noticeably.

- |  |   |
|--|---|
| • Try to adjust the vibration of your subwoofer. | → Push the <b>WOOFER</b> button on your remote control up or down to adjust its value (between -12, -6 ~ +6). |
|--|---|

## SPECIFICATIONS

<b>GENERAL</b>	<b>Weight</b>	<b>Soundbar Main Unit</b>	14.8 lbs (6.7 kg)
		<b>Subwoofer (PS-KW1-1)</b>	21.2 lbs (9.6 kg)
		<b>Surround Speaker (PS-KS2-1 (L), PS-KS2-2 (R))</b>	4.4 lbs (2.0 kg)
	<b>Dimensions (W x H x D)</b>	<b>Soundbar Main Unit</b>	47.6 x 3.2 x 5.2 inches (1210.2 x 81.7 x 131.4 mm)
		<b>Subwoofer (PS-KW1-1)</b>	8.0 x 15.7 x 16.3 inches (203.9 x 399.0 x 414.3 mm)
		<b>Surround Speaker (PS-KS2-1 (L), PS-KS2-2 (R))</b>	4.7 x 8.3 x 5.6 inches (120.2 x 210.9 x 141.0 mm)
	<b>Operating Temperature Range</b>		+41°F to +95°F (+5°C to +35°C)
<b>Operating Humidity Range</b>		10 % to 75 %	
<b>HDMI</b>	<b>Video</b>	1080p, 1080i, 720p, 576p, 480p 2160p@24/25/30Hz 4:4:4 2160p@60/50Hz 4:2:0	
<b>AMPLIFIER</b>	<b>Rated Output Power</b>	<b>Soundbar Main Unit</b>	18W x 11, 4 ohm, THD≤10%
		<b>Subwoofer (PS-KW1-1)</b>	162W, 3 ohm, THD≤10%
		<b>Surround Speaker (PS-KS2-1 (L), PS-KS2-2 (R))</b>	35W x 4, 4 ohm, THD≤10%
<b>Supported play formats</b>			LPCM 2ch, Dolby Digital, Dolby Atmos (True HD/Digital Plus), DTS

\* Design, specifications and App screen are subject to change without prior notice.

\* Nominal specification

- Samsung Electronics Co., Ltd reserves the right to change the specifications without notice.
- Weight and dimensions are approximate.
- For more information about the power supply and power consumption, refer to the label attached to the product. (Label : Bottom of main unit)
- Dispose unwanted electronics through an approved recycler. To find the nearest recycling location, go to our website: [www.samsung.com/recyclingdirect](http://www.samsung.com/recyclingdirect) or call (877) 278 - 0799.

※ **Precaution : The product will restart automatically if you turn on/off Wi-Fi/Ethernet.**

<b>Wi-Fi/Ethernet</b>	<b>Port deactivation method</b>	Press <b>Wi-Fi SETUP</b> button on the product for 30 seconds to turn Wi-Fi/Ethernet On / Off.
<b>Bluetooth</b>	<b>Port deactivation method</b>	Press <b>SPK ADD</b> button on the product for 30 seconds to turn Bluetooth On / Off.



**※ Open Source License Notice**

- For further information on Open Sources used in this product, please visit the website:  
<http://opensource.samsung.com>

**※  Spotify License**

- The Spotify Software is subject to third party licenses found here :  
[www.spotify.com/connect/third-party-licenses](http://www.spotify.com/connect/third-party-licenses).
- For more information about Spotify Connect, please visit [www.spotify.com/connect](http://www.spotify.com/connect)

**※ Important Note About Service**

- An administration fee may be charged if either:
  - a. An engineer is called out to your home at your request and there is no defect in the product.
  - b. You bring the unit to a repair center and there is no defect in the product.
- You will be advised of the amount of the administration fee before any work is done or a home visit is made.
- If you have a problem with this product, we strongly recommend you read the appropriate section of this manual, review the Troubleshooting section on page 35, visit the Support page for your product at [www.samsung.com](http://www.samsung.com), or call Samsung Product Support (1-800-726-7864) to find an answer before you contact a service center for a repair.

# WARRANTY

## LIMITED WARRANTY TO ORIGINAL PURCHASER

This SAMSUNG brand product, as supplied and distributed by Samsung Electronics America, Inc. (SAMSUNG) and delivered new, in the original carton to the original consumer purchaser, is warranted by SAMSUNG against manufacturing defects in materials and workmanship for a limited warranty period of:

**One (1) Year Parts and Labor\***  
**(\*90 Days Parts and Labor for Commercial Use)**

This limited warranty begins on the original date of purchase, and is valid only on products purchased and used in the United States. To receive warranty service, the purchaser must contact SAMSUNG for problem determination and service procedures. Warranty service can only be performed by a SAMSUNG authorized service center. The original dated bill of sale must be presented upon request as proof of purchase to SAMSUNG or SAMSUNG's authorized service center. Transportation of the product to and from the service center is the responsibility of the purchaser.

SAMSUNG will repair or replace this product, at our option and at no charge as stipulated herein, with new or reconditioned parts or products if found to be defective during the limited warranty period specified above. All replaced parts and products become the property of SAMSUNG and must be returned to SAMSUNG. Replacement parts and products assume the remaining original warranty, or ninety (90) days, whichever is longer.

SAMSUNG's obligations with respect to software products distributed by SAMSUNG under the SAMSUNG brand name are set forth in the applicable end user license agreement. Non-SAMSUNG hardware and software products, if provided, are on an "AS IS" basis. Non-SAMSUNG manufacturers, suppliers, publishers, and service providers may provide their own warranties.

This limited warranty covers manufacturing defects in materials and workmanship encountered in normal, and except to the extent otherwise expressly provided for in this statement, noncommercial use of this product, and shall not apply to the following, including, but not limited to: damage which occurs in shipment; delivery and installation; applications and uses for which this product was not intended; altered product or serial numbers; cosmetic damage or exterior finish; accidents, abuse, neglect, fire, water, lightning or other acts of nature; use of products, equipment, systems, utilities, services, parts, supplies, accessories, applications, installations, repairs, external wiring or connectors not supplied and authorized by SAMSUNG, or which damage this product or result in service problems; incorrect electrical line voltage, fluctuations and surges; customer adjustments and failure to follow operating instructions, cleaning, maintenance and environmental instructions that are covered and prescribed in the instruction book; product removal or reinstallation; reception problems and distortion related to noise, echo, interference or other signal transmission and delivery problems. SAMSUNG does not warrant uninterrupted or error-free operation of the product.

THERE ARE NO EXPRESS WARRANTIES OTHER THAN THOSE LISTED AND DESCRIBED ABOVE, AND NO WARRANTIES WHETHER EXPRESS OR IMPLIED, INCLUDING, BUT NOT LIMITED TO, ANY IMPLIED WARRANTIES OF MERCHANTABILITY OR FITNESS FOR A PARTICULAR PURPOSE, SHALL APPLY AFTER THE EXPRESS WARRANTY PERIODS STATED ABOVE, AND NO OTHER EXPRESS WARRANTY OR GUARANTY GIVEN BY ANY PERSON, FIRM OR CORPORATION WITH RESPECT TO THIS PRODUCT SHALL BE BINDING ON SAMSUNG. SAMSUNG SHALL NOT BE LIABLE FOR LOSS OF REVENUE OR PROFITS, FAILURE TO REALIZE SAVINGS OR OTHER BENEFITS, OR ANY OTHER SPECIAL, INCIDENTAL OR CONSEQUENTIAL DAMAGES CAUSED BY THE USE, MISUSE OR INABILITY TO USE THIS PRODUCT, REGARDLESS OF THE LEGAL THEORY ON WHICH THE CLAIM IS BASED, AND EVEN IF SAMSUNG HAS BEEN ADVISED OF THE POSSIBILITY OF SUCH DAMAGES. NOR SHALL RECOVERY OF ANY KIND AGAINST SAMSUNG BE GREATER IN AMOUNT THAN THE PURCHASE PRICE OF THE PRODUCT SOLD BY SAMSUNG AND CAUSING THE ALLEGED DAMAGE. WITHOUT LIMITING THE FOREGOING, PURCHASER ASSUMES ALL RISK AND LIABILITY FOR LOSS, DAMAGE OR INJURY TO PURCHASER AND PURCHASER'S PROPERTY AND TO OTHERS AND THEIR PROPERTY ARISING OUT OF THE USE, MISUSE OR INABILITY TO USE THIS PRODUCT SOLD BY SAMSUNG NOT CAUSED DIRECTLY BY THE NEGLIGENCE OF SAMSUNG. THIS LIMITED WARRANTY SHALL NOT EXTEND TO ANYONE OTHER THAN THE ORIGINAL PURCHASER OF THIS PRODUCT, IS NONTRANSFERABLE AND STATES YOUR EXCLUSIVE REMEDY.

The benefits of this Limited Warranty extend only to the original purchaser of Samsung products from an authorized Samsung reseller. THIS LIMITED WARRANTY SHALL NOT APPLY TO ANY SAMSUNG PRODUCTS PURCHASED FROM UNAUTHORIZED RESELLERS OR RETAILERS, EXCEPT IN STATES WHERE SUCH RESTRICTION MAY BE PROHIBITED. For a list of Samsung authorized retailers, please go to: [http://www.samsung.com/us/peaceofmind/authorized\\_resellers.html](http://www.samsung.com/us/peaceofmind/authorized_resellers.html)

Some states do not allow limitations on how long an implied warranty lasts, or the exclusion or limitation of incidental or consequential damages, so the above limitations or exclusions may not apply to you. This warranty gives you specific legal rights, and you may also have other rights which vary from state to state.

To obtain warranty hardware service, please contact SAMSUNG customer care center.

# SAMSUNG

The party responsible for product compliance:

Samsung Electronics Co., LTD.

America QA lab of Samsung

19 Chapin Rd. Building D,

Pine Brook, New Jersey 07058

## QUESTIONS OR COMMENTS?

COUNTRY	CALL	OR VISIT US ONLINE AT	WRITE
IN THE US	1-800-SAMSUNG (726-7864)	<a href="http://www.samsung.com/us/support">www.samsung.com/us/support</a>	Samsung Electronics America, Inc. 85 Challenger Road Ridgefield Park, NJ 07660