



# GAS RANGE USER INSTRUCTIONS

THANK YOU for purchasing this high-quality product. If you should experience a problem not covered in TROUBLESHOOTING, please visit our website at [www.whirlpool.com](http://www.whirlpool.com) for additional information. If you still need assistance, call us at 1-800-253-1301. You will need your model and serial number located on the oven frame behind the storage drawer panel.

Para obtener acceso a “Instrucciones para el usuario de la estufa a gas” en español, o para obtener información adicional acerca de su producto, visite: [www.whirlpool.com](http://www.whirlpool.com)

Tenga listo su número de modelo completo. Puede encontrar su número de modelo y de serie en la etiqueta en el marco del horno, detrás del panel del cajón de almacenamiento.

## Table of Contents

<b>RANGE SAFETY</b> .....	<b>2</b>
The Anti-Tip Bracket .....	3
<b>FEATURE GUIDE</b> .....	<b>4</b>
<b>COOKTOP USE</b> .....	<b>6</b>
Sealed Surface Burners .....	6
<b>OVEN USE</b> .....	<b>7</b>
Electronic Oven Controls .....	7
Sabbath Mode .....	8
Aluminum Foil.....	8
Positioning Racks and Bakeware.....	8
Oven Vent.....	9
Baking and Roasting.....	9
Broiling .....	9
Convection Cooking .....	9
Rapid Preheat .....	9
Timed Cooking.....	10
Warming Drawer (on some models) .....	10
<b>RANGE CARE</b> .....	<b>11</b>
Self-Cleaning Cycle (on some models) .....	11
General Cleaning.....	12
Oven Light.....	12
<b>TROUBLESHOOTING</b> .....	<b>13</b>
<b>ACCESSORIES</b> .....	<b>14</b>
<b>WARRANTY</b> .....	<b>15</b>

# RANGE SAFETY

## Your safety and the safety of others are very important.

We have provided many important safety messages in this manual and on your appliance. Always read and obey all safety messages.



This is the safety alert symbol.

This symbol alerts you to potential hazards that can kill or hurt you and others.

All safety messages will follow the safety alert symbol and either the word “DANGER” or “WARNING.”

These words mean:

**⚠ DANGER**

You can be killed or seriously injured if you don't immediately follow instructions.

**⚠ WARNING**

You can be killed or seriously injured if you don't follow instructions.

All safety messages will tell you what the potential hazard is, tell you how to reduce the chance of injury, and tell you what can happen if the instructions are not followed.

**WARNING: If the information in this manual is not followed exactly, a fire or explosion may result causing property damage, personal injury or death.**

- Do not store or use gasoline or other flammable vapors and liquids in the vicinity of this or any other appliance.
- **WHAT TO DO IF YOU SMELL GAS:**
  - Do not try to light any appliance.
  - Do not touch any electrical switch.
  - Do not use any phone in your building.
  - Immediately call your gas supplier from a neighbor's phone. Follow the gas supplier's instructions.
  - If you cannot reach your gas supplier, call the fire department.
- Installation and service must be performed by a qualified installer, service agency or the gas supplier.

**WARNING:** Gas leaks cannot always be detected by smell.

Gas suppliers recommend that you use a gas detector approved by UL or CSA.

For more information, contact your gas supplier.

If a gas leak is detected, follow the “What to do if you smell gas” instructions.

The California Safe Drinking Water and Toxic Enforcement Act requires the Governor of California to publish a list of substances known to the State of California to cause cancer, birth defects, or other reproductive harm, and requires businesses to warn of potential exposure to such substances.

**WARNING:** This product contains a chemical known to the State of California to cause cancer, birth defects, or other reproductive harm.

This appliance can cause low-level exposure to some of the substances listed, including benzene, formaldehyde, carbon monoxide, toluene, and soot.

## The Anti-Tip Bracket

The range will not tip during normal use. However, the range can tip if you apply too much force or weight to the open door without the anti-tip bracket fastened down properly.

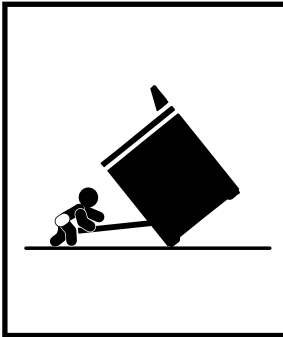

### **⚠ WARNING**

#### Tip Over Hazard

**A child or adult can tip the range and be killed.**

**Connect anti-tip bracket to rear range foot.**

**Reconnect the anti-tip bracket, if the range is moved.**

**See the installation instructions for details.**

**Failure to follow these instructions can result in death or serious burns to children and adults.**

#### Anti-Tip Bracket

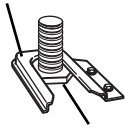

Range Foot

**Making sure the anti-tip bracket is installed:**

- Slide range forward.
- Look for the anti-tip bracket securely attached to floor.
- Slide range back so rear range foot is under anti-tip bracket.

## IMPORTANT SAFETY INSTRUCTIONS

**WARNING:** To reduce the risk of fire, electrical shock, injury to persons, or damage when using the range, follow basic precautions, including the following:

- **WARNING:** TO REDUCE THE RISK OF TIPPING OF THE RANGE, THE RANGE MUST BE SECURED BY PROPERLY INSTALLED ANTI-TIP DEVICES. TO CHECK IF THE DEVICES ARE INSTALLED PROPERLY, SLIDE RANGE FORWARD, LOOK FOR ANTI-TIP BRACKET SECURELY ATTACHED TO FLOOR, AND SLIDE RANGE BACK SO REAR RANGE FOOT IS UNDER ANTI-TIP BRACKET.
- **WARNING:** NEVER use this appliance as a space heater to heat or warm the room. Doing so may result in carbon monoxide poisoning and overheating of the oven.
- **WARNING:** NEVER cover any slots, holes or passages in the oven bottom or cover an entire rack with materials such as aluminum foil. Doing so blocks air flow through the oven and may cause carbon monoxide poisoning. Aluminum foil linings may also trap heat, causing a fire hazard.
- **CAUTION:** Do not store items of interest to children in cabinets above a range or on the backguard of a range – children climbing on the range to reach items could be seriously injured.

- Proper Installation – The range, when installed, must be electrically grounded in accordance with local codes or, in the absence of local codes, with the *National Electrical Code, ANSI/NFPA 70*. Be sure the range is properly installed and grounded by a qualified technician.
  - This range is equipped with a three-prong grounding plug for your protection against shock hazard and should be plugged directly into a properly grounded receptacle. Do not cut or remove the grounding prong from this plug.
  - Disconnect power before servicing.
  - Injuries may result from the misuse of appliance doors or drawers such as stepping, leaning, or sitting on the doors or drawers.
  - Maintenance – Keep range area clear and free from combustible materials, gasoline, and other flammable vapors and liquids.
  - Storage in or on the Range – Flammable materials should not be stored in an oven or near surface units.
  - Top burner flame size should be adjusted so it does not extend beyond the edge of the cooking utensil.
- For self-cleaning ranges –**
- Before Self-Cleaning the Oven – Remove broiler pan and other utensils. Wipe off all excessive spillage before initiating the cleaning cycle.

## SAVE THESE INSTRUCTIONS

# FEATURE GUIDE

This manual covers several models. Your model may have some or all of the items listed. Refer to this manual or the Frequently Asked Questions (FAQs) section of our website at [www.whirlpool.com](http://www.whirlpool.com) for more detailed instructions.

## ⚠ WARNING

**Food Poisoning Hazard**

**Do not let food sit in oven more than one hour before or after cooking.**

**Doing so can result in food poisoning or sickness.**

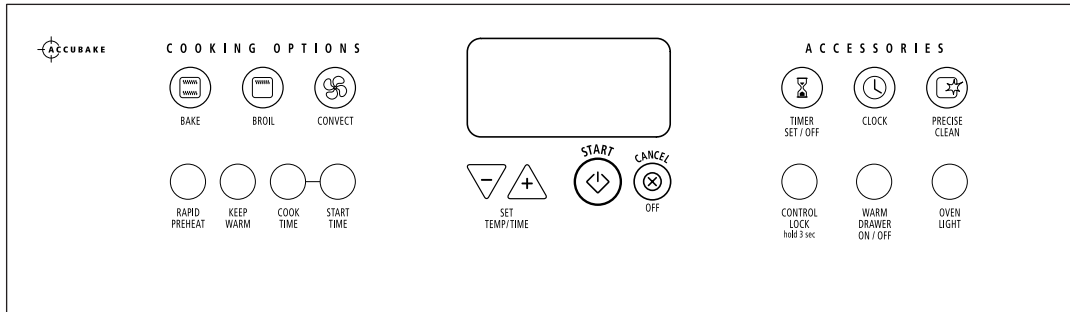

KEYPAD	FEATURE	INSTRUCTIONS
<b>OVEN LIGHT</b>	<b>Oven cavity light</b>	While the oven door is closed, press the OVEN LIGHT switch to turn the light on and off. The oven light will come on when the oven door is opened. The oven light will not come on during the Self-Clean cycle.
<b>PRECISE CLEAN™</b>	<b>Self-clean cycle</b>	See the “Range Care” section.
<b>CLOCK</b>	<b>Clock</b>	This clock can use a 12 or 24-hour cycle. See “Oven Use” section. <ol style="list-style-type: none"> <li>1. Check that the oven and Timer are off.</li> <li>2. Press CLOCK.</li> <li>3. Press SET TEMP/TIME “+” or “-” arrow pads to set the time of day.</li> <li>4. Press START.</li> </ol>
<b>TIMER SET/OFF</b>	<b>Oven timer</b>	The Timer can be set in hours or minutes up to 9 hours and 59 minutes. <ol style="list-style-type: none"> <li>1. Press TIMER SET/OFF.</li> <li>2. Press SET TEMP/TIME “+” or “-” arrow pads to set the length of time.</li> <li>3. Press START to begin the countdown. If enabled, end-of-cycle tones will sound at end of countdown.</li> <li>4. Press TIMER SET/OFF twice to cancel the Timer. Do not press the CANCEL/OFF keypad because the oven will turn off.</li> <li>5. If the Timer is running, but not in the display, press TIMER SET/OFF to display the countdown for 5 seconds.</li> </ol>
<b>WARM DRAWER ON/OFF</b>	<b>Warming drawer (on some models)</b>	Press WARM DRAWER ON/OFF to select the warming drawer function. Press WARM DRAWER ON/OFF to turn off the heating element. See the “Warming Drawer” section.
<b>CONTROL LOCK hold 3 sec</b>	<b>Oven control lockout</b>	No keypads will function with the controls locked. <ol style="list-style-type: none"> <li>1. Check that the oven and the Timer are off.</li> <li>2. Press and hold CONTROL LOCK keypad for 3 seconds.</li> <li>3. If enabled, a tone will sound, and “CONTROL LOCKED” will be displayed.</li> <li>4. Repeat to unlock.</li> </ol>

KEYPAD	FEATURE	INSTRUCTIONS
<b>BAKE</b>	<b>Baking and roasting</b>	<ol style="list-style-type: none"> <li>1. Press BAKE.</li> <li>2. Press SET TEMP/TIME "+" or "-" arrow pads to set a temperature other than 350°F (175°C) in 5° increments between 170°F and 550°F (75°C and 288°C).</li> <li>3. Press START.</li> <li>4. To change the temperature repeat steps 1 and 2. Press START or wait 5 seconds for the change to take effect.</li> <li>5. Press CANCEL/OFF when finished.</li> </ol>
<b>BROIL</b>	<b>Broiling</b>	<ol style="list-style-type: none"> <li>1. Position cookware in oven and close the oven door.</li> <li>2. Press BROIL.</li> <li>3. Press SET TEMP/TIME "+" or "-" arrow pads to set a temperature other than 550°F (285°C) in 5° increments between 170°F and 550°F (75°C and 288°C).</li> <li>4. Press START.</li> <li>5. Press CANCEL/OFF when finished.</li> </ol>
<b>CONVECT</b>	<b>Convection cooking</b>	<p>See "Convection Cooking" section for preset convection cooking options.</p> <ol style="list-style-type: none"> <li>1. Press CONVECT.</li> <li>2. Press CONVECT again to scroll through options.</li> <li>3. Press SET TEMP/TIME "+" or "-" arrow pads to set a temperature other than 325°F (162°C) in 5° increments between 170°F and 550°F (75°C and 288°C).</li> <li>4. Press START.</li> <li>5. To change the temperature repeat steps 1 and 3. Press START or wait 5 seconds for the change to take effect.</li> <li>6. Press CANCEL/OFF when finished.</li> </ol>
<b>RAPID PREHEAT</b>	<b>Preheat temperature</b>	If desired, press RAPID PREHEAT when using the Bake or Convection functions for faster preheating of the oven cavity. See "Rapid Preheat" section.
<b>KEEP WARM</b>	<b>Hold warm</b>	<p>Food must be at serving temperature before placing it in the warmed oven.</p> <ol style="list-style-type: none"> <li>1. Press KEEP WARM.</li> <li>2. Press SET TEMP/TIME "+" or "-" arrow pads to set a temperature between 145°F (63°C) and 190°F (88°C). The default temperature is 170°F (75°C).</li> <li>3. Press START.</li> <li>4. Press CANCEL/OFF when finished.</li> </ol>
<b>COOK TIME</b>	<b>Timed cooking</b>	<p>Timed Cooking allows the oven to be set to turn on at a certain time of day, cook for a set length of time, and/or shut off automatically. Delay start should not be used for foods such as breads and cakes because they may not bake properly.</p> <p>To set a Timed Cook or a Delayed Timed Cook see "Timed Cooking" section.</p>
<b>START TIME</b>	<b>Delayed start</b>	The Start Time keypad is used to enter the starting time for an oven function with a delayed start.
<b>SET TEMP/TIME</b>	<b>Temperature and time adjust</b>	The "+" or "-" arrow pads are used to adjust time and temperature settings.
<b>START</b>	<b>Cooking start</b>	The Start pad begins any oven function. If Start is not pressed within 30 seconds after pressing a keypad, the function is canceled and the time of day is displayed.
<b>CANCEL/OFF</b>	<b>Range function</b>	The Cancel/Off keypad stops any oven function except the Clock, Timer, and Control Lock.

# COOKTOP USE

## ⚠️ WARNING



### Fire Hazard

Do not let the burner flame extend beyond the edge of the pan.

Turn off all controls when not cooking.

Failure to follow these instructions can result in death or fire.

Electric igniters automatically light the surface burners when control knobs are turned to IGNITE.

Before setting a control knob, place filled cookware on the grate. Do not operate a burner using empty cookware or without cookware on the grate.

### To Set:

1. Push in and turn knob counterclockwise to IGNITE.  
All 4 surface burners will click. Only the burner with the control knob turned to IGNITE will produce a flame.
2. Turn knob to anywhere between HIGH and LOW.

**REMEMBER:** When range is in use or (on some models) during the Self-Cleaning cycle, the entire cooktop area may become hot.

### Power™ Burner Feature

The right and left front burners are designed to give ultra-power when fully on. They can be used to rapidly bring liquid to a boil and to cook large quantities of food.

### ACCUSIMMER® Burner Feature

The ACCUSIMMER® feature allows for more precise simmering and low temperature cooking. It is the right rear burner.

### Power Failure

In case of prolonged power failure, the surface burners can be lit manually. Hold a lit match near a burner and turn knob counterclockwise to IGNITE. After burner lights, turn knob to desired setting.

## Sealed Surface Burners

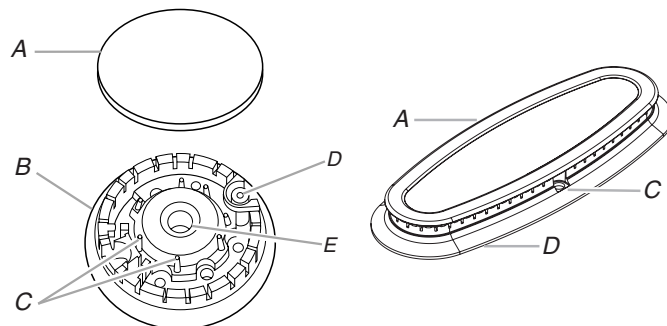

- A. Burner cap
- B. Burner base
- C. Alignment pins
- D. Igniter
- E. Gas tube opening

**IMPORTANT:** Do not obstruct the flow of combustion and ventilation air around the burner grate edges.

**Burner cap:** Always keep the burner cap in place when using a surface burner. A clean burner cap will help avoid poor ignition and uneven flames. Always clean the burner cap after a spillover and routinely remove and clean the caps according to the “General Cleaning” section.

**Gas tube opening:** Gas must flow freely throughout the gas tube opening for the burner to light properly. Keep this area free of soil and do not allow spills, food, cleaning agents or any other material to enter the gas tube opening. Keep spillovers out of the gas tube by always using a burner cap.

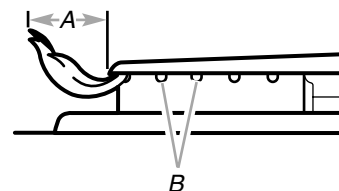

- A. 1-1/2" (25-38 mm)
- B. Burner ports

**Burner ports:** Check burner flames occasionally for proper size and shape as shown above. A good flame is blue in color, not yellow. Keep this area free of soil and do not allow spills, food, cleaning agents or any other material to enter the burner ports.

### To Clean:

**IMPORTANT:** Before cleaning, make sure all controls are off and the oven and cooktop are cool. Do not use oven cleaners, bleach or rust removers.

1. Remove the burner cap from the burner base and clean according to “General Cleaning” section.
2. Clean the gas tube opening with a damp cloth.
3. Clean clogged burner ports with a straight pin as shown. Do not enlarge or distort the port. Do not use a wooden toothpick. If the burner needs to be adjusted, contact a trained repair specialist.

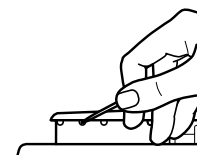

- Replace the burner cap, making sure the alignment pins are properly aligned with the burner cap.

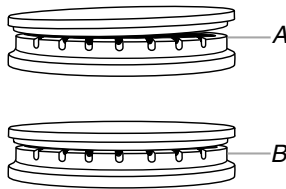

A. Incorrect  
B. Correct

- Turn on the burner. If the burner does not light, check cap alignment. If the burner still does not light, do not service the sealed burner yourself. Contact a trained repair specialist.

---

## OVEN USE

Odors and smoke are normal when the oven is used the first few times, or when it is heavily soiled.

**IMPORTANT:** The health of some birds is extremely sensitive to the fumes given off. Exposure to the fumes may result in death to certain birds. Always move birds to another closed and well-ventilated room.

---

### Electronic Oven Controls

---

#### Control Display

The display will flash when powered up or after a power loss. Press CANCEL/OFF to clear. When oven is not in use, the time of day is displayed. Indicator lights show functions that are in use.

---

#### Tones

Tones are audible signals, indicating the following:

##### One tone

- Valid pad press
- Oven is preheated (long tone)
- Function has been entered
- Reminder (on some models), repeating each minute after the end-of-cycle tones

##### Three tones

- Invalid pad press

##### Four tones

- End of cycle

#### To Change Tone Settings:

##### Tone Pitch

Sets the pitch of the tone to either high or low.

Press and hold BROIL for 5 seconds. "TONE PITCH HIGH" or "TONE PITCH LOW" will appear in the display. Press and hold BROIL again to change setting.

To exit, press CANCEL/OFF.

##### Key Press Tones

Activates or turns off the tones when a keypad is pressed.

Press and hold KEEP WARM for 5 seconds. "KEY PRESS TONES ON" or "KEY PRESS TONES OFF" will appear in the display. Press and hold KEEP WARM again to change setting.

To exit, press CANCEL/OFF.

##### End of Cycle Tone

Activates or turns off the tones that sound at the end of a cycle.

Press and hold CONVECT for 5 seconds. "CYCLE END TONE ON" or "CYCLE END TONE OFF" will appear in the display. Press and hold CONVECT again to change setting.

To exit, press CANCEL/OFF.

##### Reminder Tones Disable

Turns off the short tones that sound 1 minute after the end of cycle tones.

Press and hold BAKE for 5 seconds. "REMINDER TONES ON" or "REMINDER TONES OFF" will appear in the display. Press and hold BAKE again to change setting.

To exit, press CANCEL/OFF.

##### Audible Tones Disable

Turns off all tones, including the end of cycle tone and key press tones. Reminder tones are still active when all tones are disabled.

Press and hold CLOCK for 5 seconds. "ALL SOUNDS ON" or "ALL SOUNDS OFF" will appear in the display. Press and hold CLOCK again to change setting.

To exit, press CANCEL/OFF.

---

#### Fahrenheit and Celsius

The temperature is preset at Fahrenheit, but can be changed to Celsius.

**To change:** Press and hold PRECISE CLEAN for 5 seconds. A tone will sound, and "C" or "F" will appear on the display. Repeat to change back.

To exit, press CANCEL/OFF.

---

#### 12-Hour Shutoff

The oven control is set to automatically shut off the oven 12 hours after the oven initiates a cook or clean function. This will not interfere with any timed or delay cook functions.

Press and hold START TIME for 5 seconds to toggle to the 12-hour shutoff function. Scrolling text will display "12 HR SHUT-OFF ON" or "12 HR SHUT-OFF OFF." Press and hold to change setting.

To exit, press CANCEL/OFF.

---

#### Oven Temperature Control

**IMPORTANT:** Do not use a thermometer to measure oven temperature because opening the oven door may cause element cycling to give incorrect readings.

The oven provides accurate temperatures; however, it may cook faster or slower than your previous oven, so the temperature calibration can be adjusted. It can be changed in Fahrenheit or Celsius.

##### To Adjust Oven Temperature Calibration:

- Press and hold OVEN LIGHT for 5 seconds until the oven display shows the current calibration, for example "0°F."
- Press the SET TEMP/TIME "+" or "-" arrow pads to increase or to decrease the temperature in 5°F (3°C) amounts. The adjustment can be set between 30°F (18°C) and -30°F (-18°C).
- Press START.

---

## 12/24 Hour Clock

To change the clock mode, press and hold the “+” key for 5 seconds. Press and hold the “+” key again to change the setting. Press START to confirm the change.

---

## Scrolling Display Text

Language options are English or French.

Press the “-” key for 5 seconds to access options. Use the “-” key to scroll through the options. Press the START key to confirm your selection.

---

## Sabbath Mode

The Sabbath Mode sets the oven to remain on in a bake setting until turned off.

When the Sabbath Mode is set, all cooking and cleaning cycles are disabled. Only the Bake cycle will operate in the Sabbath Mode. No tones will sound, and the displays will not show messages or temperature changes.

When the oven door is opened or closed, the oven light will not turn on or off and the heating elements will not turn on or off immediately.

### To Enable Sabbath Mode (one time only):

1. Open oven door.
2. Press CANCEL/OFF.
3. Press and hold the “+” keypad for 5 seconds. “SABBATH ON” and “PRESS START TO ENTER” will appear in the display.
4. Press START to confirm your selection.
5. Close oven door.

### To Activate Sabbath Mode:

To use the Warm Zone and/or Warm Drawer during Sabbath Mode, press the WARM ZONE and /or WARM DRAWER keypad before activating the Sabbath Mode.

1. Press BAKE.
2. Press the “+” or “-” key to set a temperature other than 350°F (177°C).
3. Press START.  
For timed cooking in Sabbath Mode, press COOK TIME, then the “+” or “-” keys to set the desired cook time.
4. Press TIMER SET/OFF for 5 seconds. “Sab” will appear in the display.

### To Adjust Temperature (when Sabbath Mode is running):

1. Press the “+” or “-” keypad. Each press of a keypad will increase or decrease the temperature by 25°F (14°C). No temperature will appear in the display.
2. Press START.

### To Deactivate Sabbath Mode:

Press and hold TIMER SET/OFF for 5 seconds to return to regular baking or press CANCEL/OFF to turn off the range.

---

## Aluminum Foil

**IMPORTANT:** To avoid permanent damage to the oven bottom finish, do not line the oven bottom with any type of foil, liners or cookware.

For best cooking results, do not cover entire oven rack with foil because air must be able to move freely.

---

## Positioning Racks and Bakeware

**IMPORTANT:** To avoid permanent damage to the porcelain finish, do not place food or bakeware directly on the oven door or bottom.

### Bakeware

To cook food evenly, hot air must be able to circulate. Allow 2" (5 cm) of space around bakeware and oven walls. Make sure that no bakeware piece is directly over another.

### Racks

- Position racks before turning on the oven.
- Do not move racks with bakeware on them.
- Make sure racks are level.

To move a rack, pull it out to the stop position, raise the front edge, and then lift out. Use the following illustration and charts as a guide.

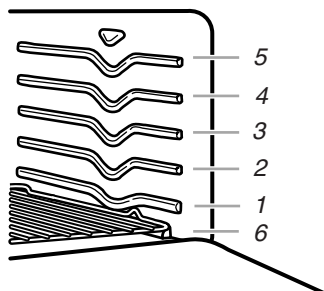

### Rack Positions

Rack 5: 2-rack baking.

Rack 4: Use for most broiling and toasting.

Rack 3: Most baked goods on a cookie sheet, jelly roll pan or in muffin pans; layer cakes; casseroles; frozen convenience foods. Broiling bone-in chicken pieces.

Rack 2: Roasting small cuts of meat and poultry. Large pan cakes, pies, yeast breads, quick breads, and 2-rack baking.

Rack 1: Roasting large cuts of meat and poultry.

Rack 6: Roasting very large poultry.

### Multiple Rack Cooking

3-rack: Use rack positions 1, 3 and 5 or 2, 3 and 5.

2-rack: Use rack positions 2 and 5.

### Baking Layer Cakes on 2 Racks

For best results when baking cakes on 2 racks use racks 2 and 5. Place the cakes on the racks as shown.

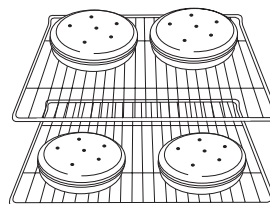



---

## Oven Vent

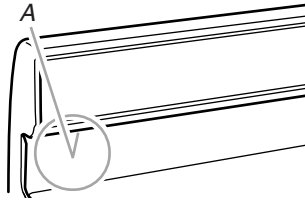

A. Oven vent (ceramic glass model)

The oven vent releases hot air and moisture from the oven, and should not be blocked or covered. Blocking or covering the vent will cause poor air circulation, affecting cooking and cleaning results. Do not set plastics, paper or other items that could melt or burn near the oven vent.

---

## Baking and Roasting

### ACCUBAKE® Temperature Management System

(on some models)

The ACCUBAKE® system electronically regulates the oven heat levels during preheat and bake to maintain a precise temperature range for optimal cooking results. The bake and broil elements or burners cycle on and off in intervals. This feature is automatically activated when the oven is in use.

Before baking and roasting, position racks according to “Positioning Racks and Bakeware” section. When roasting, it is not necessary to wait for the oven preheat cycle to end before putting food in unless it is recommended in the recipe.

### Preheating

When START is pressed, the oven will begin preheating. Once 170°F (75°C) is reached, the display temperature will increase as the actual temperature of the oven increases. When the preheat temperature is reached, a tone will sound, and the selected temperature will appear on the display.

---

## Broiling

Broiling uses direct radiant heat to cook food. Changing the temperature when broiling allows more precise control when cooking. The lower the temperature, the slower the cooking. Thicker cuts and unevenly shaped pieces of meat, fish and poultry may cook better at lower broiling temperatures.

- For best results, use a broiler pan and grid. It is designed to drain juices and help avoid spatter and smoke.

If you would like to purchase a broiler pan, one may be ordered. Please refer to the cover for contact information. Ask for Part Number 4396923.

Preheat the oven for 2 minutes before putting food in unless recommended in the recipe. Position food on grid in a broiler pan, then place it in the center of the oven rack. Close the door to ensure proper broiling temperature.

---

## Convection Cooking

During convection cooking, the bake burner cycles on and off in intervals to maintain the oven temperature, while the fan circulates the hot air.

If the oven door is opened during convection cooking, the fan will turn off immediately. It will come back on when the oven door is closed.

Convection cooking has 6 preset functions that can be selected by repeatedly pressing the CONVECT keypad.

### Convect Cook Functions

Function	Press CONVECT keypad
Convect Bake (default)	1 time
Convect Roast	2 times
Cookies	3 times
Turkey	4 times
Casserole	5 times
Frozen Pizza	6 times

---

## Rapid Preheat

Use Rapid Preheat to decrease preheating time when using Bake or Convect Bake. Use for all foods when baking on 1 rack.

For best results, use rack position 3 when using Rapid Preheat option.

For best baking and browning results, Rapid Preheat is not recommended when baking on multiple racks.

### To Use:

1. Select BAKE or CONVECT BAKE, and desired temperature.
2. Press START.
3. Press RAPID PREHEAT. Display will show “RAPID.”

When the preheat temperature is reached, a tone will sound, and the selected temperature will appear on the display.

## Timed Cooking

### **⚠ WARNING**

#### **Food Poisoning Hazard**

**Do not let food sit in oven more than one hour before or after cooking.**

**Doing so can result in food poisoning or sickness.**

#### **To Set a Timed Cook:**

1. Press BAKE, CONVECT or CONTROL BAKE (on some models).
2. Press the SET TEMP/TIME “+” or “-” arrow pads to enter a temperature other than the one displayed.
3. Press COOK TIME. The cook time oven indicator light will light up.
4. Press the SET TEMP/TIME “+” or “-” arrow pads to enter the length of time to cook.
5. Press START. The display will count down the time. When the time ends, the oven will shut off automatically.
6. Press OFF/CANCEL to clear the display.

#### **To Set a Delayed Timed Cook:**

Before setting, make sure the clock is set to the correct time of day. See the “Clock” keypad feature in the “Feature Guide” section.

1. Press BAKE, CONVECT or CONTROL BAKE (on some models).
2. Press the SET TEMP/TIME “+” or “-” arrow pads to enter a temperature other than the one displayed.
3. Press COOK TIME. The cook time oven indicator light will light up.
4. Press SET TEMP/TIME “+” or “-” arrow pads to enter the length of time to cook.
5. Press START TIME. The start time/delay oven indicator light will light up.
6. Press SET TEMP/TIME “+” or “-” arrow pads to enter the time of day to start.
7. Press START.

When the start time is reached, the oven will automatically turn on. The temperature and/or time settings can be changed anytime after pressing Start by repeating steps 1-7. When the set cook time ends, the oven will shut off automatically.

8. Press OFF/CANCEL to clear the display.

## Warming Drawer (on some models)

### **⚠ WARNING**

#### **Food Poisoning Hazard**

**Do not let food sit for more than one hour before or after cooking.**

**Doing so can result in food poisoning or sickness.**

The Warming Drawer is ideal for keeping hot cooked foods at serving temperature. It may also be used for warming breads and pastries.

Different types of food may be placed in the warming drawer at the same time. For best results, do not hold foods longer than 1 hour. For smaller quantities or heat-sensitive foods, such as eggs, do not hold longer than 30 minutes.

Food must be at serving temperature before being placed in the warming drawer. Breads, pastries, and fruit pies may be heated from room temperature.

Remove food from plastic bags and place in oven-safe container. Cover foods with a lid or aluminum foil.

Do not cover with plastic wrap.

Empty serving dishes and ovenproof dishes can be heated while the warming drawer is preheating.

Before using the warming drawer, wash the bottom of the drawer with soap and water. See “General Cleaning” section.

#### **To Use:**

1. Press WARM DRAWER ON/OFF.  
“SET TEMP OR PUSH START” will appear on the display.
2. Press SET TEMP/TIME “+” or “-” keys to select a setting between 1 (lowest) and 10 (highest)  
**OR**  
Press START.
3. Allow the warming drawer to preheat for 15 minutes.
4. Place cooked food(s) in warming drawer.
5. Press WARM DRAWER ON/OFF when finished.

The Warming Drawer operates within a temperature range of 140°F to 180°F (60°C to 82°C).

# RANGE CARE

## Self-Cleaning Cycle (on some models)

### **⚠ WARNING**



#### **Burn Hazard**

**Do not touch the oven during the Self-Cleaning cycle.**

**Keep children away from oven during Self-Cleaning cycle.**

**Failure to follow these instructions can result in burns.**

**IMPORTANT:** The health of some birds is extremely sensitive to the fumes given off during the Self-Cleaning cycle. Exposure to the fumes may result in death to certain birds. Always move birds to another closed and well-ventilated room.

Do not block the oven vent(s) during the Self-Cleaning cycle. Air must be able to move freely. Depending on your model, see “Oven Vent” section.

Do not clean, rub, damage or move the oven door gasket.

#### **Prepare Range**

- Remove the broiler pan, grid, cookware and bakeware, all cooking utensils, oven racks and aluminum foil and, on some models, the temperature probe from the oven.
- Use a damp cloth to clean inside door edge and the 1½" (3.8 cm) area around the inside oven cavity frame, being certain not to move or bend the gasket.
- Remove plastic items from the cooktop because they may melt.
- Remove all items from the storage drawer.

#### **How the Cycle Works**

**IMPORTANT:** The heating and cooling of porcelain on steel in the oven may result in discoloring, loss of gloss, hairline cracks and popping sounds.

Before self-cleaning, make sure the door is completely closed or the door will not lock and the self-cleaning cycle will not begin.

Once the oven has completely cooled, remove ash with a damp cloth. To avoid breaking the glass, do not apply a cool damp cloth to the inner door glass before it has completely cooled.

To stop the self-cleaning cycle at anytime, press CANCEL/OFF. If the temperature is too high the oven door will remain locked and “cool” and “locked” will be displayed.

Once the cleaning temperature has been reached, the electronic control requires a 12-hour delay before another self-clean cycle can be started.

The oven light will not function during the self-cleaning cycle.

#### **Electronic Oven Control with Precise Clean™ Feature (on some models)**

The Precise Clean™ self-cleaning cycle is a “one-touch” step that uses very high temperatures and dissolves soil to a powdery ash. The Precise Clean™ feature will automatically determine the length of cleaning time needed based on the number of times the oven has been used since the last self-cleaning cycle. The maximum clean time is 4 hours and the minimum clean time is 2 hours.

#### **To Self-Clean:**

1. Press PRECISE CLEAN cycle. “PRECISE CLEAN REMOVE RACKS SET CLEAN TIME OR PUSH START” will scroll in the display.
2. Press START.  
The oven door will automatically lock. “LOCKING” and the stop time will appear in the display. The remaining clean time will also be displayed.
3. When the self-clean cycle is complete and the oven cools, “UNLOCKING” will appear in the display. Press any keypad or open the oven door to clear the display.
4. When the oven is completely cooled, remove ash with a damp cloth.

---

## General Cleaning

**IMPORTANT:** Before cleaning, make sure all controls are off and the oven and cooktop are cool. Always follow label instructions on cleaning products. For additional information, you can visit the Frequently Asked Questions (FAQs) section of our website at [www.whirlpool.com](http://www.whirlpool.com).

Soap, water and a soft cloth or sponge are suggested first unless otherwise noted.

---

### EXTERIOR PORCELAIN ENAMEL SURFACES (on some models)

Food spills containing acids, such as vinegar and tomato, should be cleaned as soon as the entire range is cool. These spills may affect the finish.

#### Cleaning Method:

- Glass cleaner, mild liquid cleaner or nonabrasive scrubbing pad:  
Gently clean around the model and serial number plate because scrubbing may remove numbers.
- All-Purpose Appliance Cleaner Part Number 31682 (not included):  
See cover for contact information.

---

### STAINLESS STEEL (on some models)

**NOTE:** To avoid damage to stainless steel surfaces, do not use soap-filled scouring pads, abrasive cleaners, Cooktop Cleaner, steel-wool pads, gritty washcloths or abrasive paper towels. Damage may occur to stainless steel surfaces, even with one-time or limited use.

#### Cleaning Method:

Rub in direction of grain to avoid damaging.

- Stainless Steel Cleaner and Polish Part Number 31462 (not included):  
See cover for contact information.

Liquid detergent or all-purpose cleaner:  
Rinse with clean water and dry with soft, lint-free cloth.

---

### METALLIC PAINT (on some models)

Do not use abrasive cleaners, cleaners with bleach, rust removers, ammonia or sodium hydroxide (lye) because paint surface may stain.

---

### PORCELAIN-COATED GRATES AND CAPS

Food spills containing acids, such as vinegar and tomato, should be cleaned as soon as the cooktop, grates and caps are cool. These spills may affect the finish.

To avoid chipping, do not bang grates and caps against each other or hard surfaces such as cast iron cookware.

Do not reassemble caps on burners while wet.

Do not clean in the Self-Cleaning cycle.

#### Cleaning Method:

- Nonabrasive plastic scrubbing pad and mildly abrasive cleanser:  
Clean as soon as cooktop, grates and caps are cool.
- Dishwasher (grates only, not caps):  
Use the most aggressive cycle. Cooked-on soils should be soaked or scrubbed before going into a dishwasher.
- Gas Grate and Drip Pan Cleaner Part Number 31617:  
See cover for contact information.

---

### SURFACE BURNERS

- See “Sealed Surface Burners” section.

---

### COOKTOP CONTROLS

To avoid damage to the cooktop controls, do not use steel wool, abrasive cleansers or oven cleaner.

Do not soak knobs. When replacing knobs, make sure knobs are in the OFF position.

On some models, do not remove seals under knobs.

#### Cleaning Method:

- Soap and water:  
Pull knobs straight away from control panel to remove.

---

### CONTROL PANEL AND OVEN DOOR EXTERIOR

To avoid damage to the control panel, do not use abrasive cleaners, steel-wool pads, gritty washcloths or abrasive paper towels.

#### Cleaning Method:

- Glass cleaner and soft cloth or sponge:  
Apply glass cleaner to soft cloth or sponge, not directly on panel.
- All-Purpose Appliance Cleaner Part Number 31682 (not included):  
See cover for contact information.

---

### OVEN RACKS

#### Cleaning Method:

- Steel-wool pad
- For racks that have discolored and are harder to slide, a light coating of vegetable oil applied to the rack guides will help them slide.

---

### STORAGE DRAWER

Check that storage drawer is cool and empty before cleaning.

#### Cleaning Method:

- Mild detergent

---

## Oven Light

The oven light is a standard 40-watt appliance bulb. Before replacing, make sure the oven and cooktop are cool and the control knobs are in the off position.

#### To Replace:

1. Unplug range or disconnect power.

2. Turn the glass bulb cover in the back of the oven counterclockwise to remove.
3. Turn bulb counterclockwise to remove from socket.
4. Replace bulb, then bulb cover by turning clockwise.
5. Plug in range or reconnect power.

---

# TROUBLESHOOTING

First try the solutions suggested here or visit our website and reference Frequently Asked Questions (FAQs) to possibly avoid the cost of a service call.

[www.whirlpool.com](http://www.whirlpool.com)

---

## Nothing will operate

**⚠ WARNING**



**Electrical Shock Hazard**  
**Plug into a grounded 3 prong outlet.**  
**Do not remove ground prong.**  
**Do not use an adapter.**  
**Do not use an extension cord.**  
**Failure to follow these instructions can result in death, fire, or electrical shock.**

- **Is the power supply cord unplugged?**  
Plug into a grounded 3 prong outlet.
  - **Household fuse blown or circuit breaker tripped?**  
Replace the fuse or reset the circuit breaker. If the problem continues, call an electrician.
  - **Is the main or regulator gas shutoff valve in the off position?**  
See Installation Instructions.
  - **Is the range properly connected to the gas supply?**  
Contact a trained repair specialist or see Installation Instructions.
- 

## Surface burners will not operate

- **Is the oven in self-clean?**  
Surface burners will not operate during self-clean cycle.
  - **Is the control knob set correctly?**  
Push in knob before turning to a setting.
  - **Is this the first time the surface burners have been used?**  
Turn on any one of the surface burner knobs to release air from the gas lines.
  - **Are the burner ports clogged?**  
See "Sealed Surface Burners" section.
- 

## Surface burner flames are uneven, yellow and/or noisy

- **Are the burner ports clogged?**  
See "Sealed Surface Burners" section.
  - **On models with caps, are the burner caps positioned properly?**  
See "Sealed Surface Burners" section.
  - **Is propane gas being used?**  
The range may have been converted improperly. Contact a service technician or see cover for contact information.
- 

## Surface burner makes popping noises

- **Is the burner wet?**  
Let it dry.
- 

## Gas range noises during Bake and Broil operations

Noises that may be heard during the Bake and Broil operations: Whooshing, Poof, Clicking, Snaps, Pop

These sounds are normal operational noises that can be heard each time the Bake or Broil burners ignite during the cycle.

- A pop can be heard when the gas valve is opening or cycling on and will make a single pop when it snaps open from the solenoid. It sounds similar to a suction cup being pulled off of a piece of glass.
  - The igniters will click several times until the flame is detected. These are short clicking sounds like tapping a nail onto a piece of glass.
  - A whooshing or poof sound is heard when the Bake or Broil burner ignites.
  - On some models, a clicking sound can be heard when the convection fan relay cycles on and off.
- 

## Excessive heat around cookware on cooktop

- **Is the cookware the proper size?**  
Use cookware about the same size as the surface cooking area, element or surface burner. Cookware should not extend more than ½" (1.3 cm) outside the cooking area.
- 

## Cooktop cooking results not what expected

- **Is the proper cookware being used?**  
Ideal cookware should have a flat bottom, straight sides and a well fitting lid, and the material should be of a medium to heavy thickness.
  - **Is the control knob set to the proper heat level?**  
See "Cooktop Use" section.
  - **Is the range level?**  
Level the range. See the Installation Instructions.
- 

## Oven will not operate

- **Is this the first time the oven has been used?**  
Turn on any one of the surface burner knobs to release air from the gas lines.
  - **Is the electronic oven control set correctly?**  
See "Electronic Oven Controls" section.
- 

## Oven burner flames are yellow or noisy

- **Is propane gas being used?**  
The range may have been converted improperly. Contact a service technician or see cover for contact information.
- 

## Oven temperature too high or too low

- **Does the oven temperature calibration need adjustment?**  
See "Oven Temperature Control" section of the "Electronic Oven Controls" section.
-

---

### Display shows messages

- **Is the display showing a flashing time?**  
There has been a power failure. Clear the display. On some models, reset the clock, if needed. See “Clock” keypad feature in the “Feature Guide” section.
- **Is the display showing a letter followed by a number?**  
Depending on your model, press OFF/CANCEL or CANCEL/OFF to clear the display. See “Control Display” in the “Electronic Oven Controls” section. If it reappears, call for service. See cover for contact information.
- **Is the display showing a flashing “PUSH?” or “PSH”?**  
See the “Start” keypad feature in the “Feature Guide” section.

---

### Self-Cleaning cycle will not operate

- **Is the oven door open?**  
Close the oven door all the way.
- **Has the function been entered?**  
See “Self-Cleaning Cycle” section.
- **Has a delay start been set? (on some models)**  
See “Timed Cooking” section.
- **Has a self-clean cycle been run in the past 12 hours?**  
If a self-clean cycle has been run, or canceled after the oven has reached temperature, you will have to wait 12 hours to restart.

---

### Oven cooking results not what expected

- **Is the range level?**  
Level the range. See the Installation Instructions.
- **Is the proper temperature set?**  
Double-check the recipe in a reliable cookbook.
- **Is the proper oven temperature calibration set?**  
See “Oven Temperature Control” section of the “Electronic Oven Controls” section.
- **Was the oven preheated?**  
See “Baking and Roasting” section.
- **Are the racks positioned properly?**  
See “Positioning Racks and Bakeware” section.
- **Is there proper air circulation around bakeware?**  
See “Positioning Racks and Bakeware” section.
- **Is the batter evenly distributed in the pan?**  
Check that batter is level in the pan.
- **Is the proper length of time being used?**  
Adjust cooking time.
- **Has the oven door been opened while cooking?**  
Oven peeking releases oven heat and can result in longer cooking times.
- **Are baked items too brown on the bottom?**  
Move rack to higher position in the oven.
- **Are pie crust edges browning early?**  
Use aluminum foil to cover the edge of the crust and/or reduce baking temperature.

---

## ACCESSORIES

### Stainless Steel Cleaner and Polish

(stainless steel models)  
Order Part Number 31462

### All-Purpose Appliance Cleaner

Order Part Number 31682

### Gas Grate and Drip Pan Cleaner

Order Part Number 31617

### Split-Rack with Removable Insert

Order Part Number 4396927

### Broiler Pan

Order Part Number 4396923

---

# WHIRLPOOL CORPORATION MAJOR APPLIANCE WARRANTY

---

## LIMITED WARRANTY

For one year from the date of purchase, when this major appliance is operated and maintained according to instructions attached to or furnished with the product, Whirlpool Corporation or Whirlpool Canada LP (hereafter "Whirlpool") will pay for Factory Specified Parts and repair labor to correct defects in materials or workmanship. Service must be provided by a Whirlpool designated service company. This limited warranty is valid only in the United States or Canada and applies only when the major appliance is used in the country in which it was purchased. Outside the 50 United States and Canada, this limited warranty does not apply. Proof of original purchase date is required to obtain service under this limited warranty.

---

## ITEMS EXCLUDED FROM WARRANTY

### This limited warranty does not cover:

1. Service calls to correct the installation of your major appliance, to instruct you on how to use your major appliance, to replace or repair house fuses, or to correct house wiring or plumbing.
2. Service calls to repair or replace appliance light bulbs, air filters or water filters. Consumable parts are excluded from warranty coverage.
3. Repairs when your major appliance is used for other than normal, single-family household use or when it is used in a manner that is contrary to published user or operator instructions and/or installation instructions.
4. Damage resulting from accident, alteration, misuse, abuse, fire, flood, acts of God, improper installation, installation not in accordance with electrical or plumbing codes, or use of consumables or cleaning products not approved by Whirlpool.
5. Cosmetic damage, including scratches, dents, chips or other damage to the finish of your major appliance, unless such damage results from defects in materials or workmanship and is reported to Whirlpool within 30 days from the date of purchase.
6. Any food loss due to refrigerator or freezer product failures.
7. Costs associated with the removal from your home of your major appliance for repairs. This major appliance is designed to be repaired in the home and only in-home service is covered by this warranty.
8. Repairs to parts or systems resulting from unauthorized modifications made to the appliance.
9. Expenses for travel and transportation for product service if your major appliance is located in a remote area where service by an authorized Whirlpool servicer is not available.
10. The removal and reinstallation of your major appliance if it is installed in an inaccessible location or is not installed in accordance with published installation instructions.
11. Major appliances with original model/serial numbers that have been removed, altered or cannot be easily determined. This warranty is void if the factory applied serial number has been altered or removed from your major appliance.

The cost of repair or replacement under these excluded circumstances shall be borne by the customer.

---

## DISCLAIMER OF IMPLIED WARRANTIES; LIMITATION OF REMEDIES

CUSTOMER'S SOLE AND EXCLUSIVE REMEDY UNDER THIS LIMITED WARRANTY SHALL BE PRODUCT REPAIR AS PROVIDED HEREIN. IMPLIED WARRANTIES, INCLUDING WARRANTIES OF MERCHANTABILITY OR FITNESS FOR A PARTICULAR PURPOSE, ARE LIMITED TO ONE YEAR OR THE SHORTEST PERIOD ALLOWED BY LAW. WHIRLPOOL SHALL NOT BE LIABLE FOR INCIDENTAL OR CONSEQUENTIAL DAMAGES. SOME STATES AND PROVINCES DO NOT ALLOW THE EXCLUSION OR LIMITATION OF INCIDENTAL OR CONSEQUENTIAL DAMAGES, OR LIMITATIONS ON THE DURATION OF IMPLIED WARRANTIES OF MERCHANTABILITY OR FITNESS, SO THESE EXCLUSIONS OR LIMITATIONS MAY NOT APPLY TO YOU. THIS WARRANTY GIVES YOU SPECIFIC LEGAL RIGHTS, AND YOU MAY ALSO HAVE OTHER RIGHTS WHICH VARY FROM STATE TO STATE OR PROVINCE TO PROVINCE.

---

If outside the 50 United States and Canada, contact your authorized Whirlpool dealer to determine if another warranty applies. 9/07

---

For additional product information, in the U.S.A., visit [www.whirlpool.com](http://www.whirlpool.com).

If you do not have access to the Internet and you need assistance using your product or you would like to schedule service, you may contact Whirlpool at the number below.

*Have your complete model number ready. You can find your model number and serial number on the label, located on the oven frame behind the storage drawer panel.*

For assistance or service in the U.S.A., call 1-800-253-1301.

If you need further assistance, you can write to Whirlpool with any questions or concerns at the address below:

Whirlpool Brand Home Appliances  
Customer eXperience Center  
553 Benson Road  
Benton Harbor, MI 49022-2692

Please include a daytime phone number in your correspondence.

Please keep this User Instructions and model number information for future reference.

**W10196151B**  
**SP PN W10204500A**

© 2008 Whirlpool Corporation.  
All rights reserved.

© Registered Trademark/TM Trademark of Whirlpool, U.S.A.

8/08  
Printed in U.S.A.