



User Guide

Microwave Hood Combination

THANK YOU for purchasing this high-quality product. Register your microwave oven at www.whirlpool.com.

For future reference, please make a note of your model and serial number located on the front facing of the microwave oven opening, behind the door.

Model Number _____ Serial Number _____

Para una versión de estas instrucciones en español, visite www.whirlpool.com

Deberá tener a mano el número de modelo y de serie, que están ubicados en la parte frontal de la abertura del horno de microondas, detrás de la puerta.

MICROWAVE HOOD COMBINATION SAFETY

Your safety and the safety of others are very important.

We have provided many important safety messages in this manual and on your appliance. Always read and obey all safety messages.



This is the safety alert symbol.

This symbol alerts you to potential hazards that can kill or hurt you and others.

All safety messages will follow the safety alert symbol and either the word "DANGER" or "WARNING."

These words mean:

⚠ DANGER

You can be killed or seriously injured if you don't immediately follow instructions.

⚠ WARNING

You can be killed or seriously injured if you don't follow instructions.

All safety messages will tell you what the potential hazard is, tell you how to reduce the chance of injury, and tell you what can happen if the instructions are not followed.

IMPORTANT SAFETY INSTRUCTIONS

When using electrical appliances basic safety precautions should be followed, including the following:

WARNING: To reduce the risk of burns, electric shock, fire, injury to persons, or exposure to excessive microwave energy:

- Read all instructions before using the microwave oven.
- Read and follow the specific "PRECAUTIONS TO AVOID POSSIBLE EXPOSURE TO EXCESSIVE MICROWAVE ENERGY" found in this section.
- The microwave oven must be grounded. Connect only to properly grounded outlet. See "GROUNDING INSTRUCTIONS" found in this section and in the provided Installation Instructions.
- Install or locate the microwave oven only in accordance with the provided Installation Instructions.
- Some products such as whole eggs in the shell and sealed containers - for example, closed glass jars - are able to explode and should not be heated in the microwave oven.

SAVE THESE INSTRUCTIONS



W1124880B

IMPORTANT SAFETY INSTRUCTIONS

- Use the microwave oven only for its intended use as described in the manual. Do not use corrosive chemicals or vapors in the microwave oven. This type of oven is specifically designed to heat, cook, or dry food. It is not designed for industrial or laboratory use.
- As with any appliance, close supervision is necessary when used by children.
- Do not operate the microwave oven if it has a damaged cord or plug, if it is not working properly, or if it has been damaged or dropped.
- The microwave oven should be serviced only by qualified service personnel. Call an authorized service company for examination, repair, or adjustment.
- Do not cover or block any openings on the microwave oven.
- Do not store this microwave oven outdoors. Do not use the microwave oven near water - for example, near a kitchen sink, in a wet basement, near a swimming pool, or similar locations.
- Do not immerse cord or plug in water.
- Keep cord away from heated surfaces.
- Do not let cord hang over edge of table or counter.
- See door surface cleaning instructions in the "Microwave Oven Care" section.
- To reduce the risk of fire in the oven cavity:
 - Do not overcook food. Carefully attend the microwave oven when paper, plastic, or other combustible materials are placed inside the oven to facilitate cooking.
 - Remove wire twist-ties from paper or plastic bags before placing bags in oven.
 - If materials inside the oven ignite, keep oven door closed, turn oven off, and disconnect the power cord, or shut off power at the fuse or circuit breaker panel.
 - Do not use the cavity for storage purposes. Do not leave paper products, cooking utensils, or food in the cavity when not in use.
- Liquids, such as water, coffee, or tea are able to be overheated beyond the boiling point without appearing to be boiling. Visible bubbling or boiling when the container is removed from the microwave oven is not always present. **THIS COULD RESULT IN VERY HOT LIQUIDS SUDDENLY BOILING OVER WHEN THE CONTAINER IS DISTURBED OR A SPOON OR OTHER UTENSIL IS INSERTED INTO THE LIQUID.**
To reduce the risk of injury to persons:
 - Do not overheat the liquid.
 - Stir the liquid both before and halfway through heating it.
 - Do not use straight-sided containers with narrow necks.
 - After heating, allow the container to stand in the microwave oven for a short time before removing the container.
 - Use extreme care when inserting a spoon or other utensil into the container.
- Do not mount over a sink.
- Do not store anything directly on top of the microwave oven when the microwave oven is in operation.
- Clean Ventilating Hoods Frequently - Grease should not be allowed to accumulate on hood or filter.
- When flambing foods under the hood, turn the fan on.
- Suitable for use above both gas and electric cooking equipment.
- Intended to be used above ranges with maximum width of 36" (91.44 cm).
- Use care when cleaning the vent-hood filter. Corrosive cleaning agents, such as lye-based oven cleaners, may damage the filter.

SAVE THESE INSTRUCTIONS

PRECAUTIONS TO AVOID POSSIBLE EXPOSURE TO EXCESSIVE MICROWAVE ENERGY

- (a) Do not attempt to operate this oven with the door open since open-door operation can result in harmful exposure to microwave energy. It is important not to defeat or tamper with the safety interlocks.
- (b) Do not place any object between the oven front face and the door or allow soil or cleaner residue to accumulate on sealing surfaces.
- (c) Do not operate the oven if it is damaged. It is particularly important that the oven door close properly and that there is no damage to the:
 - (1) Door (bent),
 - (2) Hinges and latches (broken or loosened),
 - (3) Door seals and sealing surfaces.
- (d) The oven should not be adjusted or repaired by anyone except properly qualified service personnel.

State of California Proposition 65 Warnings:

WARNING: This product contains one or more chemicals known to the State of California to cause cancer.

WARNING: This product contains one or more chemicals known to the State of California to cause birth defects or other reproductive harm.

Electrical Requirements

⚠ WARNING



Electrical Shock Hazard

Plug into a grounded 3 prong outlet.

Do not remove ground prong.

Do not use an adapter.

Do not use an extension cord.

Failure to follow these instructions can result in death, fire, or electrical shock.

Observe all governing codes and ordinances.

Required:

- A 120-volt, 60 Hz, AC-only, 15- or 20-amp electrical supply with a fuse or circuit breaker.

Recommended:

- A time-delay fuse or time-delay circuit breaker.
- A separate circuit serving only this microwave oven.

GROUNDING INSTRUCTIONS

■ **For all cord connected appliances:**

The microwave oven must be grounded. In the event of an electrical short circuit, grounding reduces the risk of electric shock by providing an escape wire for the electric current. The microwave oven is equipped with a cord having a grounding wire with a grounding plug. The plug must be plugged into an outlet that is properly installed and grounded.

WARNING: Improper use of the grounding plug can result in a risk of electric shock. Consult a qualified electrician or serviceman if the grounding instructions are not completely understood, or if doubt exists as to whether the microwave oven is properly grounded.

Do not use an extension cord. If the power supply cord is too short, have a qualified electrician or serviceman install an outlet near the microwave oven.

SAVE THESE INSTRUCTIONS

This device complies with Part 18 of the FCC Rules.

OPERATING YOUR MICROWAVE OVEN

Settings

Clock

The clock is a 12-hour (12:00-11:59) clock. Touch CLOCK, enter time, then touch CLOCK or the Start control.

Timer

With the microwave oven in Standby mode, touch the Timer control, enter time, then touch the Timer control or the Start control. Cook functions may be entered while the Timer is counting down. To cancel timer, touch Timer control while the Timer countdown is active in the display.

Control Lock

Activate to avoid unintended start. Touch and hold the Cancel keypad for about 3 seconds until 2 tones sound and the CONTROL LOCKED appears in the display. When locked, touching any button on the keyboard (except for the hood control buttons and Cancel) will not work. Repeat to unlock control.

Vent Fan

Press the Vent Fan keypad once for High setting. You may press this keypad repeatedly and choose a different speed. There are three available speeds HIGH--->MEDIUM--->MEDIUM LOW--LOW--->OFF. Choose the speed you want.

To keep the microwave oven from overheating, the auto hood fan will automatically turn on at high speed if the temperature from the range or cooktop below the microwave oven gets too hot. When this occurs, the hood fan cannot be turned off.

Vent Light

Pressing Vent Light keypad adjusts the vent light setting among HIGH -> LOW -> OFF.

Options/Clock

Press Clock repeatedly, there are various options/setting may be adjusted:

1-Clock; 2-Sound; 3-Scrolling Speed; 4-Language (~~on Canada model only~~); 5-Filter Reset; 6-Fan Timer; 7-Demo Mode; 8-Factory Reset.

Sound (Tones)

Keypad tones and volume can be adjusted. Press CLOCK to reach the Sound submenu.

1. Button Tones On and Off: Press 1-On 2-Off

2. Volume: Press 1-Low, 2-Med, 3-High

Pressing the Start keypad, pressing the CLOCK keypad will save.

Scroll Speed

Scrolling speed options will be between Low, Medium and High speeds. Press CLOCK to reach the scrolling speed submenu. Once you select speed, press start or CLOCK keypad will save.

Language

There are two languages supported: English and French. Press CLOCK to reach the Language submenu. Once options for language is selected you'll have two options. Press start or CLOCK keypad will save.

Filter Reset

Reset the filter status after replacing and/or cleaning the filters. Touch CLOCK to reach the Filter Reset submenu, and activate reset.

Fan Timer

Set vent fan to run for exactly 30 minutes or to run for only 30 minutes more (off after 30 minutes). The vent fan may be turned off at any time using the Vent Fan keypad. Touch CLOCK to reach the Fan Timer submenu and select the setting.

Demo Mode

Activate to practice using the control without actually turning on the magnetron. Touch CLOCK to reach the Demo mode submenu, then follow the prompts to activate. The Clock or : will light up in the display. Repeat to deactivate.

If the microwave oven has not been used for 5 min (no key press for 5min), the display will show "DEMO ON".

Features

CLEANRELEASE® Cavity Coating (on some models)

The durable, nonstick coating resists soil buildup by making cleaning easier. See the "Microwave Oven Care" section.

6th SENSE™ System

A sensor in the microwave oven detects moisture released from food as it heats and adjusts the cooking time accordingly.

Cookware and Dinnerware

Microwave-Safe

- Browning dish (Follow manufacturer recommendations)
- Ceramic glass, glass
- China, earthenware (Follow manufacturer recommendations)
- Melamine (Follow manufacturer recommendations)
- Paper towels, paper plates, napkins (Use non-recycled paper)
- Plastic wraps, bags, covers, dinnerware, containers (Follow manufacturer recommendations)
- Pottery and clay (Follow manufacturer recommendations)
- Silicone bakeware (Follow manufacturer recommendations)
- Wax paper

To Test Cookware/Dinnerware: Place dish in microwave oven with 1 cup (250 mL) of water beside it. Program 1 minute of cook time at 100%. If dish becomes hot and the water stays cool, do not use the dish in the microwave oven.

Microwave Oven Use

~~For list of preset programs, see the Quick Reference Guide provided with your model.~~

Manual Cooking

Touch number keypads to enter time, touch POWER (if not 100%), touch number keypads to enter power level (10-90), then touch the Start control.

Sensor Cooking

A sensor in the microwave oven detects moisture released from food as it heats and adjusts the cooking time accordingly.

Make sure microwave oven has been plugged in for at least 1 minute. Use microwave-safe dish with loose-fitting lid or cover microwave-safe dish with plastic wrap, and vent. For optimal performance, wait at least 30 minutes after convection cooking or grilling (on some models) before sensor cooking.

Standby Mode

When no functions are working (12-hour clock is displayed or if the clock has not been set), oven will switch to Standby Power mode and dim the LCD brightness after 2 minutes. Press any button or open/close the door, and display will return to the normal brightness.

Turntable

Turntable may be turned off for manual cooking only. This is helpful when cooking with plates that are bigger than the turntable or when cooking with plates that are side by side. Turntable cannot be turned off during preset or sensor (on some models) functions.

Do Not Use

- Metal cookware and bakeware
- Straw or wicker
- Gold, silver, or pewter
- Non-approved meat thermometers, skewers
- Twist ties
- Foil liners, such as sandwich wrappers
- Staples
- Objects with gold or silver trim or with metallic glaze

Preset Cooking, Reheating, Defrosting

Touch COOK or REHEAT or DEFROST repeatedly to scroll through program options. Rest on desired program options. Follow prompts to select submenu items and/or amounts, then press the Start control.

Popcorn

Two choices, press Popcorn repeatedly.

Large bag: Senses 3.0-3.5 oz (85-99g)

Small bag: 1.75 oz (50g) only

Place bag on turntable then touch Start control. Listen for popping to slow to 1 pop every 1 or 2 seconds, then stop the cycle. Cooking results may vary by brand and fat content. For other bag sizes use manual cooking.

Preset Steam/Simmer

Touch STEAM/SIMMER, repeatedly to scroll through program options. Rest on desired program options. Follow prompts to select submenu items and/or amounts, then press the Start control.

MENU PROGRAMS: Touch the menu control repeatedly to scroll through program options. Rest on the desired program options. Follow display prompts to select submenu items and/or amounts, and then start the program. Any invalid entry will cause an Invalid Tone and be corrected to a value that is within range and closest to the entered value.

COOK

1. Bacon: 1, 2, 3, 4, 5 or 6 slices, average thickness:
Follow directions on package.
2. Canned Vegetables: 1, 2, 3, 4 cups (250mL - 1 L)
Place in microwave-safe container. Cover with plastic wrap, and vent. Stir and let stand 2-3minutes after cooking.
3. Fresh Vegetables: Senses 1 - 4 cups (250mL - 1 L)
Place in microwave-safe container. Add 2-4 tbs (30-60mL) water. Cover with plastic wrap, and vent. Stir and let stand 2-3minutes after cooking.
4. Frozen Vegetables: Senses 1 - 4 cups (250mL - 1 L)
Remove from package. Place in microwave-safe container. Add 2-4tbs (30-60 mL) water. Cover with plastic wrap, and vent. Stir and let stand 2-3minutes after cooking.
5. Frozen Entrée : 10, 20, 40, 60 ounces (283, 567, 1134, 1701g).
Remove from package. Loosen cover on 3 sides. If entrée is not in microwave-safe container, place on plate, cover with plastic wrap, and vent.
6. Small potato: Enter 1-4 pieces, 4-7 oz (113-198g) each.
Pierce each potato several times with a fork. Place on paper towel, around turntable edges, at least 1" (2.5 cm) apart. Let stand 5 minutes after cooking.
7. Large potato: Sense 1-4 potatoes, 8-10 oz (227-283g) each.
Pierce each potato several times with a fork. Place on paper towel, around turntable edges, at least 1" (2.5 cm) apart. Let stand 5 minutes after cooking.
8. Rice: Senses 0.5-2.0 cups (125-500mL) dry, white long grain:
Follow measurements on package for ingredient amounts. Use microwave-safe dish with loose-fitting lid. Let stand 5 minutes after cooking, or until liquid is absorbed. Stir.

REHEAT

1. Baked Goods: 1, 2, 3, 4, 5 or 6 servings:
Place on paper towel. Two small rolls may be counted as 1 serving.
2. Beverage: 1, 2 cups, 8 oz (250mL) each.
Do not cover. The diameter of the cup's opening will affect how the liquid heats. Beverages in cups with smaller openings may heat faster.
3. Casserole: 1, 2, 3, 4 cups (250mL - 1 L)
Place in microwave-safe container and cover with plastic wrap. Stir and let stand 2-3minutes after reheating.
4. Dinner Plate: Senses 1 serving (1 plate), 8-16 oz (227-454g):
Place food on microwave-safe plate, cover with plastic wrap, and vent.
5. Pizza: 1, 2, 3 slices, 4 oz (113g) each
Place on paper towel lined paper plate.
6. Sauce: Senses 1-4 cups (250mL - 1 L)
Place in microwave-safe container and cover with plastic wrap. Stir and let stand 2-3 minutes after reheating.
7. Soup: Sense 1,2,3,4 cups (250mL -1L)
Place in microwave-safe container and cover with plastic wrap. Stir and let stand 2-3minutes after reheating.

DEFROST

1. Poultry: 0.2-6.6 lbs (90g - 3 kg) Remove wrap and place in microwave-safe dish. Do not cover.
2. Meat: 0.2-6.6 lbs (90g - 3 kg)
Remove wrap and place in microwave-safe dish. Do not cover.
3. Fish: 0.2-4.4 lbs (90g - 2 kg)
Remove wrap and place in microwave-safe dish. Do not cover.
4. Quick: 1.0 lb - 454g
Remove wrap and place in microwave-safe dish. Do not cover. Turn over food at signal.

STEAM/SIMMER (sensor):

Use microwave-safe container with a loose-fitting lid. Sensor will detect when liquid begins to boil, then the Steam or Simmer countdown will start.

NOTE: Do not remove the lid while the container is in the microwave oven, as a rush of steam would disrupt the sensor readings.

Place small microwave-safe dish (for example, custard dish) with 2-4tbs (30-60 mL) water in center of container. Use 2tbs (30mL) water for smaller quantities, or 4tbs (60mL) water for larger quantities of food. Place food in container around the small dish. Cover with loose-fitting lid.

1. Steam Fresh Vegetable – Senses 1-4 cups (250 mL-1 L):
For best results, cut into equally sized pieces.
2. Steam Frozen Vegetable – Senses 1-4 cups (250 mL-1 L).
3. Boneless Chicken – Senses 0.5-1.5 lbs (142-680 g).
4. Steam Potato – Senses 1-4 cups (250 mL-1 L):
For best results, cut into equally sized pieces.
5. Manual Steam: Touch the number keypads to set a length of time to steam. Time can be set up to 99 minutes and 59 seconds.
6. Manual Simmer: Touch the number keypads to set a length of time to steam. Time can be set up to 99 minutes and 59 seconds.

MICROWAVE OVEN CARE

Installing/Replacing Filters and Light Bulbs

NOTE: A Filter Status indicator (on some models) appears in the display when it is time to replace the charcoal filter, and clean or replace the grease filters. See the “Settings” section to reset filter status.

- **Grease filters:** Grease filters are underside of microwave oven. The grease filters should be removed and cleaned at least once a month.

NOTE: For recirculation: Do not operate the microwave oven without the filters in place.

For wall and roof ventilation: To ensure good performance of airflow, remove the charcoal filter from the bottom plate before operating the microwave oven.

Refer the following steps for replacing grease filter:

1. To remove the grease filter and charcoal filter, push the finger grip back and then pull down from the bottom plate.

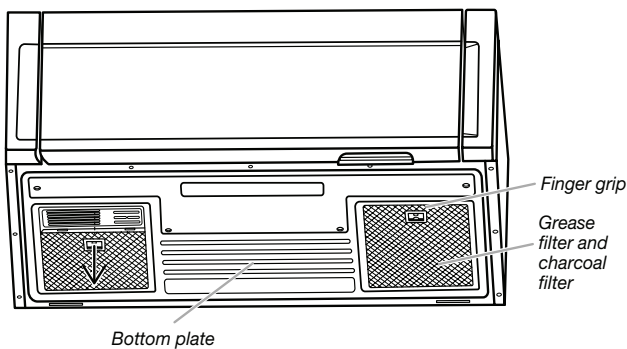

2. Separate the grease filter from the charcoal filter.

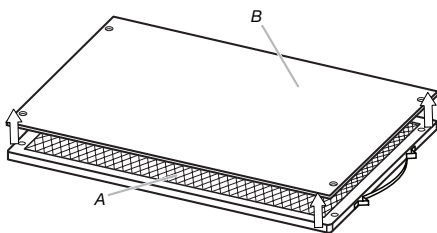

A. Grease filter
B. Charcoal filter

3. Clean the grease filter monthly, or replace with new grease filter if necessary.
4. Reattach the grease filter to the charcoal filter.

5. Put the grease filter and charcoal filter back to the bottom plate.

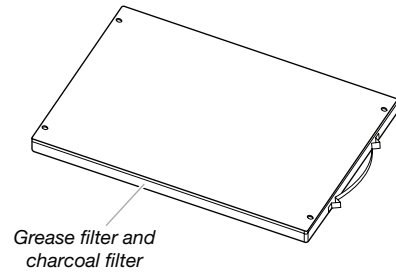

- **Charcoal filters:** Charcoal filters are underside of microwave oven. The charcoal filter cannot be cleaned and should be replaced about every 6 months.

NOTE: For recirculation: Do not operate the microwave oven without the filters in place.

For wall and roof ventilation: To ensure good performance of airflow, remove the charcoal filter from the bottom plate before operating the microwave oven.

Refer the following steps for replacing charcoal filter:

1. To remove the grease filter and charcoal filter, push the finger grip back and then pull down from the bottom plate.

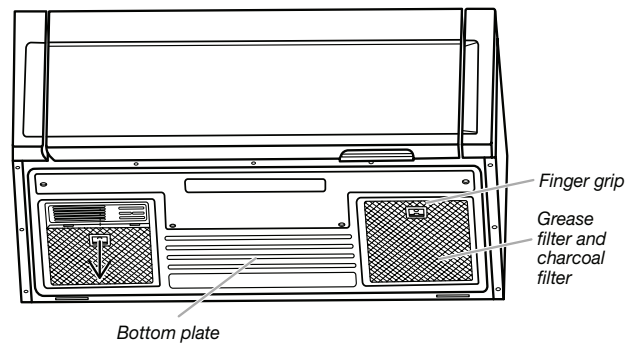

2. Separate the charcoal filter from the grease filter.

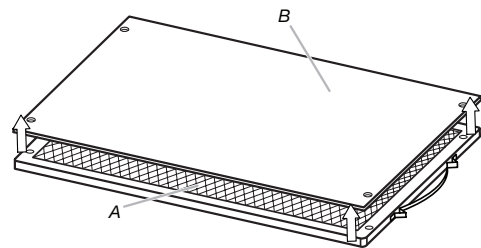

A. Grease filter
B. Charcoal filter

3. Replace a new charcoal filter and reattach it back to grease filter.
4. Put the grease filter and charcoal filter back to the bottom plate.

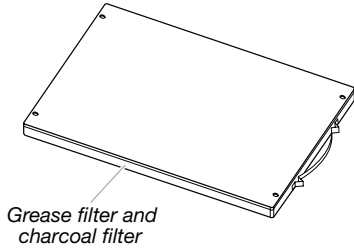

4. Replace a new LED, press it back between two hooks and plug in the terminal.

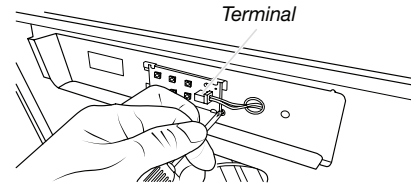

5. Using a Phillips screwdriver, reattach the 4 screws back to "T" shape bottom lighting cover.

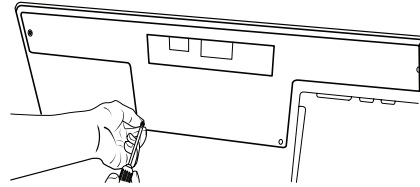

■ **Cooktop light:** The cooktop light is located on the underside of the microwave oven and is replaceable.

To replace the cooktop light refer the following steps:

1. Using a philips screwdriver, remove the 4 screws from the "T" shaped bottom lighting cover.

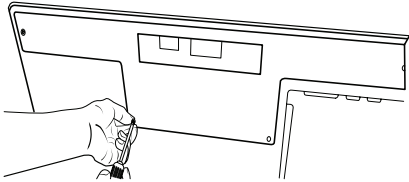

■ **Cavity light:** The cavity light is located at the top front of the microwave oven, under the cover, and is replaceable.

To replace the cavity light refer the following steps:

1. Using a Phillips screwdriver, remove the second left vent top cover screw from the top front of the microwave oven.

2. Push the 2 hooks backward, and take the LED out.

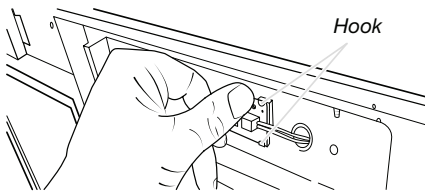

3. Unplug the terminal from the LED board.

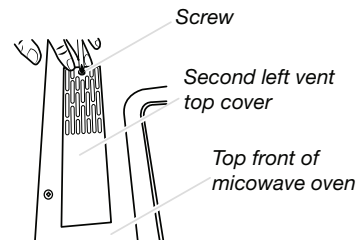
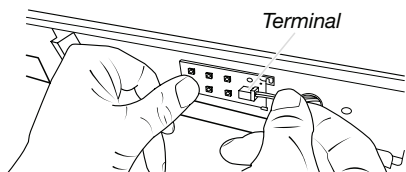

2. Remove the second left top cover.

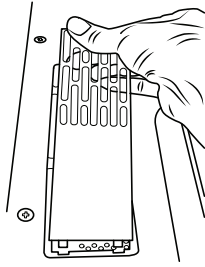

3. Take out LED board.

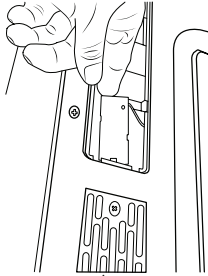

4. Unplug the LED terminal.

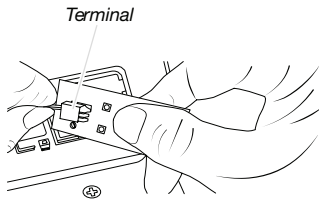

5. Replace a new LED, and snap it into the hook.

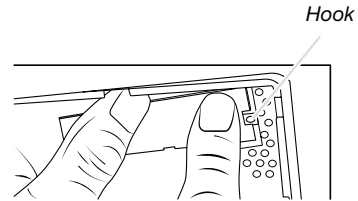

6. Reattach the second top vent cover with the screw removed in step 1.

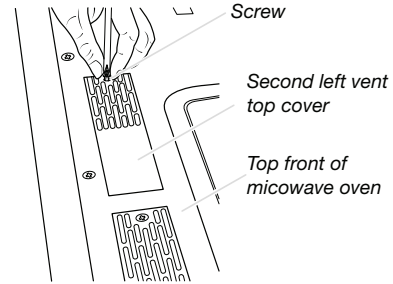

ACCESSORIES

Following is a list of available parts and supplies which may be purchased separately. Please refer to the "Warranty" section for contact information.

Replacement Parts

- Turntable
- Turntable support and rollers
- Turntable hub
- Grease filter
- Charcoal filter
- Cooktop light bulb
- Cavity light bulb

Cleaning Supplies

- Heavy-duty degreaser
- Affresh® Kitchen Appliance Cleaner
- Affresh® Stainless Steel Cleaner
- Affresh® Stainless Steel Wipes

TROUBLESHOOTING

If you experience	Recommended Solutions
Microwave oven will not operate	<p>Check the following:</p> <ul style="list-style-type: none"> ■ Household fuse or circuit breaker - If a household fuse has blown or a circuit breaker has tripped, replace the fuse or reset the circuit breaker. If the problem continues, call an electrician. ■ Magnetron - Try to heat 1 cup (250 mL) of cold water for 2 minutes at 100% cooking power. If water does not heat, try the steps in the bullets below. If microwave oven still does not operate, call for service. ■ Door - Firmly close door. On some models, if a packaging spacer is attached to inside of the door, remove it, then firmly close door. If a message about the door appears in the display, the door has been closed for 5 minutes or more without the microwave oven being started. This occurs to avoid unintended starting of the microwave oven. Open and close the door, then start the cycle. ■ Control - Make sure control is set properly. Make sure Control Lock is OFF. Make sure Demo mode (on some models) is OFF.
Arcing in the microwave oven	<p>Check the following:</p> <ul style="list-style-type: none"> ■ Soil buildup - Soil buildup on cavity walls, microwave inlet cover, cooking rack supports, and area where the door touches the frame can cause arcing. See "General Cleaning" in the "Microwave Oven Care" section.
Turntable alternates rotation directions	<ul style="list-style-type: none"> ■ This is normal and depends on motor rotation at the beginning of the cycle.
Display shows messages	<ul style="list-style-type: none"> ■ "Enter clock" with flashing digits means there has been a power failure. Reset the clock. ■ A letter followed by a number is an error indicator. Call for assistance.
Fan running during cooktop usage	<ul style="list-style-type: none"> ■ This is normal. The microwave oven's cooling fan, which is separate from the vent fan, automatically comes on during microwave oven operation to cool the microwave oven. It may also automatically come on and cycle on and off to cool the microwave oven's controls while the cooktop below is being used.
Radio, TV, or cordless phone interference	<p>Check the following:</p> <ul style="list-style-type: none"> ■ Proximity - Move the receiver away from the microwave oven, or adjust the radio or TV antenna. ■ Soil - Make sure the microwave oven door and sealing surfaces are clean. ■ Frequency - Some 2.4 GHz-based cordless phones and home wireless networks may experience static or noise while microwave oven is ON. Use a corded phone, a different frequency cordless phone, or avoid using these items during microwave oven operation.

WHIRLPOOL® MAJOR APPLIANCE LIMITED WARRANTY

ATTACH YOUR RECEIPT HERE. PROOF OF PURCHASE IS REQUIRED TO OBTAIN WARRANTY SERVICE.

Please have the following information available when you call the Customer eXperience Center:

- Name, address and telephone number
- Model number and serial number
- A clear, detailed description of the problem
- Proof of purchase including dealer or retailer name and address

IF YOU NEED SERVICE:

1. Before contacting us to arrange service, please determine whether your product requires repair. Some questions can be addressed without service. Please take a few minutes to review the Troubleshooting or Problem Solver section of the Use and Care Guide, or visit www.whirlpool.com/product_help.
2. All warranty service is provided exclusively by our authorized Whirlpool Service Providers. In the U.S. and Canada, direct all requests for warranty service to:

Whirlpool Customer eXperience Center

In the U.S.A., call 1-800-253-1301. In Canada, call 1-800-807-6777.

If outside the 50 United States or Canada, contact your authorized Whirlpool dealer to determine whether another warranty applies.

ONE YEAR LIMITED WARRANTY

WHAT IS COVERED

For one year from the date of purchase, when this major appliance is installed, operated and maintained according to instructions attached to or furnished with the product, Whirlpool Corporation or Whirlpool Canada LP (hereafter "Whirlpool") will pay for Factory Specified Replacement Parts and repair labor to correct defects in materials or workmanship that existed when this major appliance was purchased, or at its sole discretion replace the product. In the event of product replacement, your appliance will be warranted for the remaining term of the original unit's warranty period.

YOUR SOLE AND EXCLUSIVE REMEDY UNDER THIS LIMITED WARRANTY SHALL BE PRODUCT REPAIR AS PROVIDED HEREIN. Service must be provided by a Whirlpool designated service company. This limited warranty is valid only in the United States or Canada and applies only when the major appliance is used in the country in which it was purchased. This limited warranty is effective from the date of original consumer purchase. Proof of original purchase date is required to obtain service under this limited warranty.

WHAT IS NOT COVERED

1. Commercial, non-residential, multiple-family use, or use inconsistent with published user, operator or installation instructions.
2. In-home instruction on how to use your product.
3. Service to correct improper product maintenance or installation, installation not in accordance with electrical or plumbing codes or correction of household electrical or plumbing (i.e. house wiring, fuses or water inlet hoses).
4. Consumable parts (i.e. light bulbs, batteries, air or water filters, preservation solutions, etc.).
5. Defects or damage caused by the use of non-genuine Whirlpool parts or accessories.
6. Conversion of products from natural gas or propane gas.
7. Damage from accident, misuse, abuse, fire, floods, acts of God or use with products not approved by Whirlpool.
8. Repairs to parts or systems to correct product damage or defects caused by unauthorized service, alteration or modification of the appliance.
9. Cosmetic damage including scratches, dents, chips, and other damage to the appliance finishes unless such damage results from defects in materials and workmanship and is reported to Whirlpool within 30 days.
10. Discoloration, rust or oxidation of surfaces resulting from caustic or corrosive environments including but not limited to high salt concentrations, high moisture or humidity or exposure to chemicals.
11. Food or medicine loss due to product failure.
12. Pick-up or delivery. This product is intended for in-home repair.
13. Travel or transportation expenses for service in remote locations where an authorized Whirlpool servicer is not available.
14. Removal or reinstallation of inaccessible appliances or built-in fixtures (i.e. trim, decorative panels, flooring, cabinetry, islands, countertops, drywall, etc.) that interfere with servicing, removal or replacement of the product.
15. Service or parts for appliances with original model/serial numbers removed, altered or not easily determined.

The cost of repair or replacement under these excluded circumstances shall be borne by the customer.

DISCLAIMER OF IMPLIED WARRANTIES

IMPLIED WARRANTIES, INCLUDING ANY IMPLIED WARRANTY OF MERCHANTABILITY OR IMPLIED WARRANTY OF FITNESS FOR A PARTICULAR PURPOSE, ARE LIMITED TO ONE YEAR OR THE SHORTEST PERIOD ALLOWED BY LAW. Some states and provinces do not allow limitations on the duration of implied warranties of merchantability or fitness, so this limitation may not apply to you. This warranty gives you specific legal rights, and you also may have other rights that vary from state to state or province to province.

DISCLAIMER OF REPRESENTATIONS OUTSIDE OF WARRANTY

Whirlpool makes no representations about the quality, durability, or need for service or repair of this major appliance other than the representations contained in this warranty. If you want a longer or more comprehensive warranty than the limited warranty that comes with this major appliance, you should ask Whirlpool or your retailer about buying an extended warranty.

LIMITATION OF REMEDIES; EXCLUSION OF INCIDENTAL AND CONSEQUENTIAL DAMAGES

YOUR SOLE AND EXCLUSIVE REMEDY UNDER THIS LIMITED WARRANTY SHALL BE PRODUCT REPAIR AS PROVIDED HEREIN. WHIRLPOOL SHALL NOT BE LIABLE FOR INCIDENTAL OR CONSEQUENTIAL DAMAGES. Some states and provinces do not allow the exclusion or limitation of incidental or consequential damages, so these limitations and exclusions may not apply to you. This warranty gives you specific legal rights, and you also may have other rights that vary from state to state or province to province.

NOTES

NOTES