BERTAZZONI MASTER SERIES

48" UNDERMOUNT AND WALLMOUNT HOOD, 2 MOTOR
K48 HD 2X



Dual-Motor Bertazzoni Master Series hoods are a bold design solution for the contemporary professional-style kitchen. The heavy-duty dual motors deliver a combined 1200 CFM extraction power with multiple settings. They can be installed under a cabinet or on the wall, with optional medium or wide duct covers. Stainless-steel baffle filters can be easily removed and are dishwasher safe.



TO COOK BEAUTIFULLY

BERTAZZONI MASTER SERIES

48" UNDERMOUNT AND WALLMOUNT HOOD, 2 MOTOR K48 HD 2X

FEATURES

Hood finishing	stainless steel
Motor	2
Speed	3
Hood control	electronic with buttons
Halogen lights	4
Filters	baffle stainless steel
Max extraction power	1200 cfm

TECHNICAL SPECIFICATIONS

Voltage, Frequency	120 V, 60 Hz
Max Amp usage, power rating	6.6 A - 800 W
Certification	cETLus
Warranty	2 years parts and labor

ACCESSORIES

Medium duct cover	code 901263
Full-width duct cover	code 901261
Air bracket	code 901264

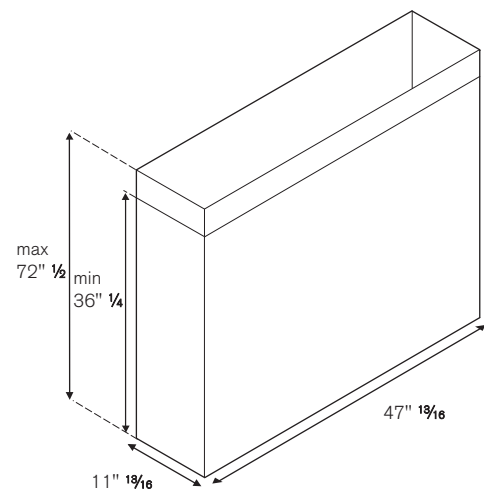
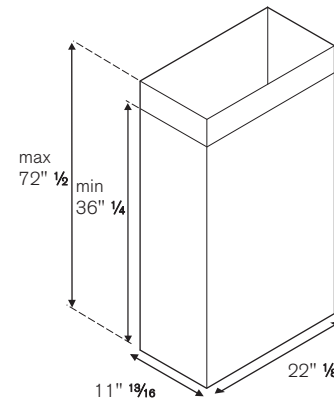
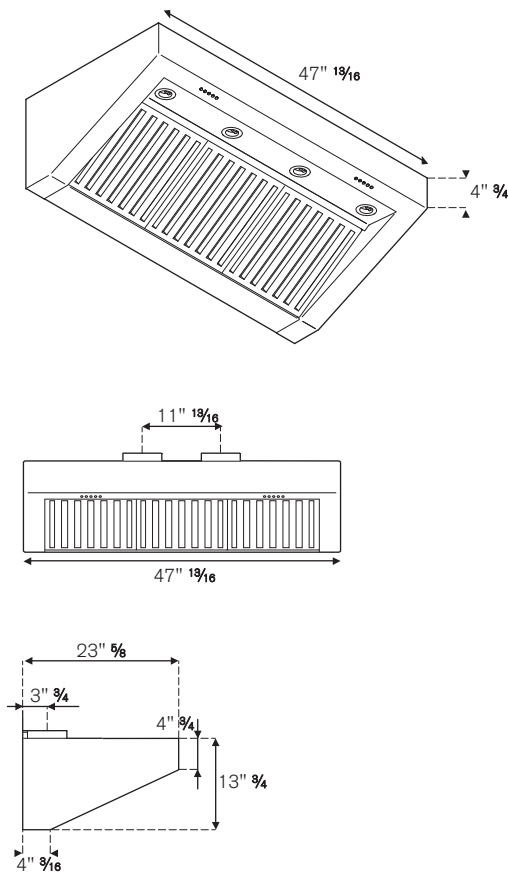

INSTALLATION INSTRUCTIONS

Bertazzoni recommends to operate the appliance after it has been properly installed. Please refer to the installation manual for further details.

Disclaimer: while every effort has been made to insure the accuracy of the information contained in this brochure, Fratelli Bertazzoni reserves the right to change any part of the information at any time without notice.

Fratelli Bertazzoni, Bertazzoni and the winged wheel brand icon are registered trademarks of Bertazzoni Spa.