

800 Series

30" Single Wall Oven, HBL8442UC, Black Stainless Steel

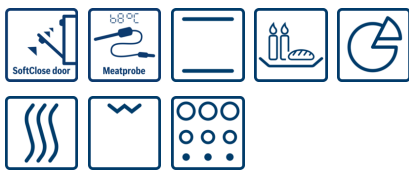

Included accessories

1 x oven racks /upper
1 x temperature probe /upper

Optional accessories

HEZTR301 : Telescopic Oven Rack 30"

The Bosch black stainless steel helps guard against scratches and fingerprints

Introducing a Newly Designed and Engineered Bosch Wall Oven Featuring a QuietClose™ Door

- Dampened Hinges Softly and Quietly Guide the QuietClose™ Door Shut.
- A Full-Extension Telescopic Rack Offers Safe Access to the Oven Cavity.
- Touch Control with SteelTouch™ Buttons Makes Operating the Oven Easier.
- The Wall Oven is Designed to be Installed Flush with your Cabinetry.
- Wall Ovens are Compatible with Most Competitors' Cut-Outs.

Technical Data

Cooking mode :	3rd element convection, Convection Bake, Convection Broil, Convection Roast, Conventional heat, Dough proving setting, Half width variable grill, Pizza setting, Top heating, 1/3 bottom heat., warming
Integrated Cleaning system :	Self Clean
Interior Lights - cavity 1 :	2
Timer settings :	Alarm, Off, On, timer
Included accessories :	
1 x oven racks /upper, 1 x temperature probe /up	
Bake Element Wattages cavity 1 (W) :	2400
Broil Element Wattages cavity 1 (W) :	3800
Convection Element Wattages cavity 1 (W) :	2000
UPC code :	825225950134
Product color :	Stainless steel
Energy source :	Electric
Watts (W) :	5000
Current (A) :	30
Volts (V) :	240/208
Frequency (Hz) :	60
Approval certificates :	CSA
Power cord length (in) :	50"
Power cord length (cm) :	127
Plug type :	fixed connection, no plug
Required cutout size (HxWxD) (in) :	
27" - 28 5/8" x 28 1/2" x 23 1/2"	
Required cutout size (HxWxD) (mm) :	686-727 x 724-724 x 597
Overall appliance dimensions (HxWxD) (mm) :	737 x 755 x 622
Product packaging dimensions (HxWxD) (in) :	
31 1/4" x 34" x 31 1/2"	
Product packaging dimensions (HxWxD) (mm) :	
863 x 787 x 863	
Net weight (lbs) :	171
Net weight (kg) :	77.8
Gross weight (lbs) :	193
Gross weight (kg) :	88.0

800 Series Ovens

30" Single Wall Oven, HBL8442UC, Black Stainless Steel

The Bosch black stainless steel helps guard against scratches and fingerprints

Introducing a Newly Designed and Engineered Bosch Wall Oven Featuring a QuietClose™ Door

Design

- Touch control with SteelTouch™ Buttons for Easier Operation of the Oven

Performance

- 12 Specialized Cooking Modes - Gourmet Cooking Made Easy
- Custom Cooking Modes: Pizza, Pie, Warm and Proof
- Genuine European Convection
- Temperature Conversion for Convection Cooking
- Meat Probe Takes Guesswork out of Cooking
- Fast Preheat Reduces Preheat Time

Efficiency

- EcoClean™ 2-Hour Self-Clean Cycle

Convenience

- Two Oven Lights to Better Monitor Cooking Progress
- Timer with Cook Time and Delay Start Function
- Extra Large Door Window for Easy Monitoring of Cooking Process
- Star-K certified. 100°-450° F

Capacity

- Large Capacity at 4.6 Cu Ft.
- Recessed 8 Pass Broil Element for Increased Capacity and Safety

800 Series Ovens

30" Single Wall Oven, HBL8442UC, Black Stainless Steel

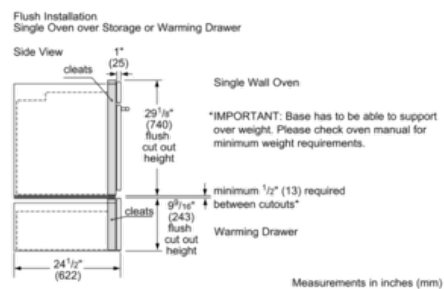
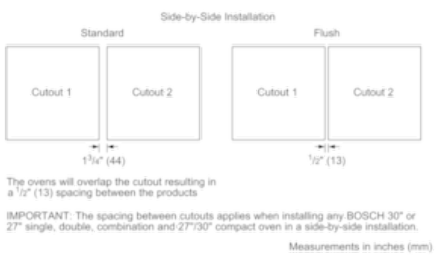
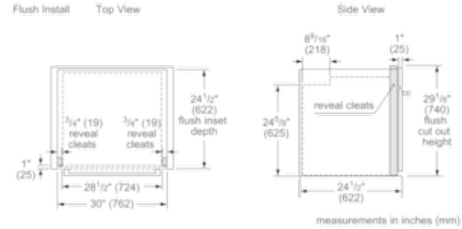
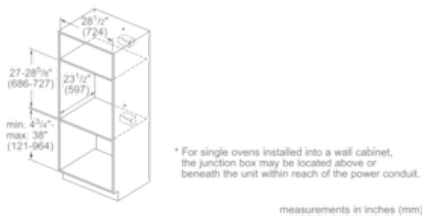
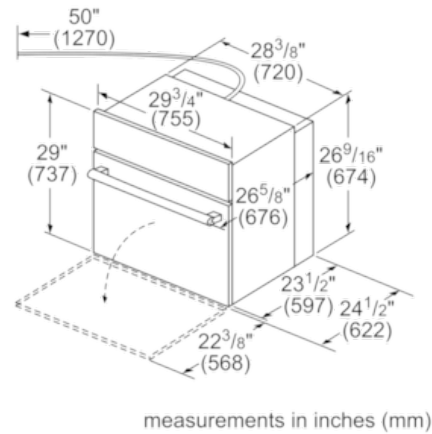
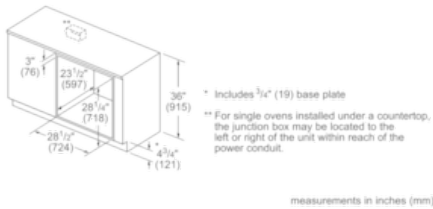

800 Series Ovens

30" Single Wall Oven, HBL8442UC, Black Stainless Steel

Standard Installation
30" Single Oven over Storage or Warming Drawer

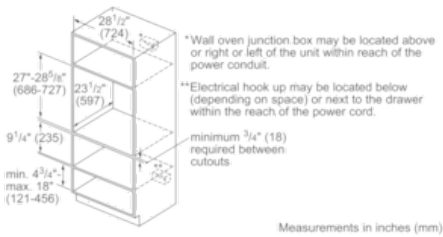

Flush Installation
Single Oven over Storage or Warming Drawer

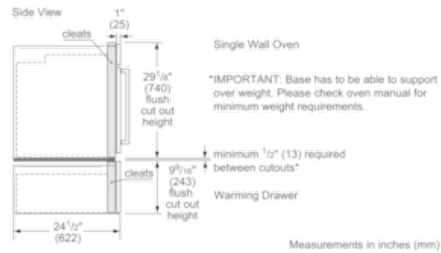

Standard Installation
30" Steam Convection Oven over Single Oven**

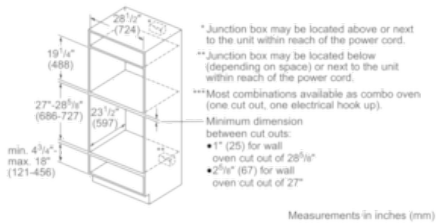

Flush Installation
Steam Convection Oven over Single Oven**

