



DISTINCT BY DESIGN™

# Owner's Manual

## MICROWAVE OVEN

Model: CVM721

### Contents

<b>Safety Information</b> .....	3	<b>Care And Cleaning</b> .....	21
<b>Using the Microwave</b>		<b>Troubleshooting</b> .....	23
Features .....	6	<b>Limited Warranty</b> .....	25
About the Features .....	7	<b>Consumer Support</b> .....	26
Other Features .....	15		
WiFi Connect .....	20		
Remote Enabled Equipment .....	20		

Write the model and serial numbers here:

Model # \_\_\_\_\_

Serial # \_\_\_\_\_

You can find them on a label under the cooktop.

**English • Español**

## THANK YOU FOR MAKING CAFÉ A PART OF YOUR HOME.

---

We take pride in the craftsmanship, innovation and design that goes into every Café product, and we think you will too. Among other things, registration of your appliance ensures that we can deliver important product information and warranty details when you need them.

Register your Café appliance now online. Helpful websites are available in the Consumer Support section of this Owner's Manual. You may also mail in the pre-printed registration card included in the packing material.

**C A F É**

---

DISTINCT BY DESIGN™

# IMPORTANT SAFETY INSTRUCTIONS

## READ ALL INSTRUCTIONS BEFORE USING THE APPLIANCE

### **⚠ WARNING**

To reduce the risk of burns, electric shock, fire, injury to persons, or exposure to excessive microwave energy:

When using electrical appliances, basic safety precautions should be followed, including the following:

- Read all instructions before using this appliance.
- Read and follow the specific "PRECAUTIONS TO AVOID POSSIBLE EXPOSURE TO EXCESSIVE MICROWAVE ENERGY" found on page 5.
- Use this appliance only for its intended use as described in this manual. Do not use corrosive chemicals or vapors in this appliance. This microwave oven is specifically designed to heat, dry or cook food, and is not intended for laboratory or industrial use.
- This appliance should be serviced only by qualified service personnel. Contact nearest authorized service facility for examination, repair, or adjustment.

### **INSTALLATION**

- Install or locate this appliance only in accordance with the provided installation instructions.
- This appliance must be grounded. Connect only to a properly grounded outlet. See the "GROUNDING INSTRUCTIONS" found on page 5.
- This microwave oven is UL listed for installation over both gas and electric ranges.
- This unit is suitable for use above gas or electric cooking equipment, 36" or less wide.
- Do not operate this appliance if it has a damaged power cord or plug, if it is not working properly, or if it has been damaged or dropped.
- Keep power cord away from heated surfaces.
- Do not let cord hang over edge of table or counter.
- Do not immerse power cord or plug in water.
- Do not cover or block any opening on the appliance.
- Do not store this appliance outdoors. Do not use this product near water - for example, in a wet basement, near a swimming pool, or in a similar location.
- Do not mount over a sink.

### **TO REDUCE THE RISK OF FIRE IN THE CAVITY:**

- Do not overcook food. Carefully attend appliance when paper, plastic or other combustible materials are placed inside the oven while cooking.
- Remove wire twist-ties and metal handles from paper or plastic containers before placing them in the oven.
- If materials inside the oven ignite, keep the oven door closed, turn the oven off and disconnect the power cord, or shut off power at the fuse or circuit breaker panel.
- Do not store any materials in the oven when not in use. Do not leave paper products, cooking utensils, or food in the cavity when not in use.
- Do not operate the microwave feature without food in the oven.

### **TO REDUCE THE RISK OF BURNS**

- Be careful when opening containers of hot food. Use pot holders and direct steam away from face and hands.
- Vent, pierce, or slit containers, pouches or plastic bags to prevent build-up of pressure.
- Be careful when touching the turntable, door, or walls of the oven which may become hot during use.
- Liquids and certain foods heated in the microwave oven can present a risk of burn when removing them from the microwave. The potential for a burn is greater in young children, who should not be allowed to remove hot items from the microwave.

## READ AND SAVE THESE INSTRUCTIONS

# IMPORTANT SAFETY INSTRUCTIONS

## READ ALL INSTRUCTIONS BEFORE USING THE APPLIANCE

### ⚠ WARNING

#### OPERATING

- As with any appliance, close supervision is necessary when used by children.
- Do not operate the oven without the turntable in place. The turntable must be unrestricted so it can turn.
- Make sure all cookware used in your microwave oven is suitable for microwaving. Most glass casseroles, cooking dishes, measuring cups, custard cups, pottery or china dinnerware which does not have metallic trim or glaze with a metallic sheen can be used in compliance with cookware manufacturers' recommendations.
- Do not store anything directly on top of the microwave surface when the microwave is in operation.
- Some products such as whole eggs and sealed containers - for example, closed jars - are able to explode and should not be heated in the microwave oven.
- Do not overcook potatoes. They could dehydrate and catch fire.
- Do not cover any other part of the oven with metal foil. This will cause overheating of the oven.
- Cook meat and poultry thoroughly—meat to at least an INTERNAL temperature of 160°F and poultry to at least an INTERNAL temperature of 180°F. Cooking to these temperatures usually protects against foodborne illness.
- This oven is not approved or tested for marine use.

#### CLEANING

- Keep the oven free from grease buildup.
- Do not clean with metal scouring pads. Pieces can burn off the pad and touch electrical parts involving risk of electric shock.
- When cleaning surfaces of door and oven that come together on closing the door, use only mild, nonabrasive soaps, or detergents applied with a clean sponge or soft cloth. Rinse well.

#### SUPER HEATED WATER

- Liquids, such as water, coffee, or tea, are able to be overheated beyond the boiling point without appearing to be boiling. Visible bubbling or boiling when the container is removed from the microwave oven is not always present. **THIS COULD RESULT IN VERY HOT LIQUIDS SUDDENLY BOILING OVER WHEN THE CONTAINER IS DISTURBED OR A SPOON OR OTHER UTENSIL IS INSERTED INTO THE LIQUID.**
- To reduce the risk of injury to persons:
  - Do not overheat the liquid.
  - Stir the liquid both before and halfway through heating it.
  - Do not use straight-sided containers with narrow necks.
  - After heating, allow the container to stand in the microwave oven for a short time before removing the container.
  - Use extreme care when inserting a spoon or other utensil into the container.

**READ AND SAVE THESE INSTRUCTIONS**

# IMPORTANT SAFETY INSTRUCTIONS

## READ ALL INSTRUCTIONS BEFORE USING THE APPLIANCE

### PRECAUTIONS TO AVOID POSSIBLE EXPOSURE TO EXCESSIVE MICROWAVE ENERGY

- (a) **Do Not Attempt** to operate this oven with the door open since open-door operation can result in harmful exposure to microwave energy. It is important not to defeat or tamper with the safety interlocks.
- (b) **Do Not Place** any object between the oven front face and the door or allow soil or cleaner residue to accumulate on sealing surfaces.
- (c) **Do Not Operate** the oven if it is damaged. It is particularly important that the oven door close properly and that there is no damage to the:
- (1) door (bent),
  - (2) hinges and latches (broken or loosened),
  - (3) door seals and sealing surfaces.
- (d) **The Oven Should Not** be adjusted or repaired by anyone except properly qualified service personnel.

### GROUNDING INSTRUCTIONS

#### ⚠ WARNING

Improper use of the grounding plug can result in a risk of electric shock.

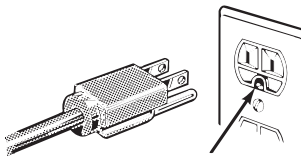

Ensure proper ground exists before use.

This appliance must be grounded. In the event of an electrical short circuit, grounding reduces the risk of electric shock by providing an escape wire for the electric current.

This appliance is equipped

with a power cord having a grounding wire with a grounding plug. The plug must be plugged into an outlet that is properly installed and grounded.

Consult a qualified electrician or service technician if the **GROUNDING INSTRUCTIONS** are not completely understood, or if doubt exists as to whether the appliance is properly grounded.

If the outlet is a standard 2-prong wall outlet, it is your personal responsibility and obligation to have it replaced with a properly grounded 3-prong wall outlet.

Do not under any circumstances cut or remove the third (ground) prong from the power cord.

Do not use an extension cord. If the power cord is too short, have a qualified electrician or service technician install an outlet near the appliance.

For best operation, plug this appliance into its own electrical outlet to prevent flickering of lights, blowing of fuse or tripping of circuit breaker.

#### NOTICE: PACEMAKERS

Most pacemakers are shielded from interference from electronic products, including microwaves. However, patients with pacemakers may wish to consult their physicians if they have concerns.

#### VENT FAN

#### ⚠ WARNING

The fan will operate automatically under certain conditions. Take care to prevent the starting and spreading of accidental cooking fires while the vent fan is in use.

- Clean the underside of the microwave often. Do not allow grease to build up on the microwave or the fan filters.
- In the event of a grease fire on the surface units below the microwave oven, smother a flaming pan on the surface unit by covering the pan completely with a lid, a cookie sheet or a flat tray.
- Use care when cleaning the vent fan filters. Corrosive cleaning agents, such as lye-based oven cleaners, may damage the filters.
- When preparing flaming foods under the microwave, turn the fan on.
- Never leave surface units beneath your microwave oven unattended at high heat settings. Boilovers cause smoking and greasy spillovers that may ignite and spread if the microwave vent fan is operating. To minimize automatic fan operation, use adequate sized cookware and use high heat on surface units only when necessary.

## READ AND SAVE THESE INSTRUCTIONS

## Features

Throughout this manual, features and appearance may vary from your model.

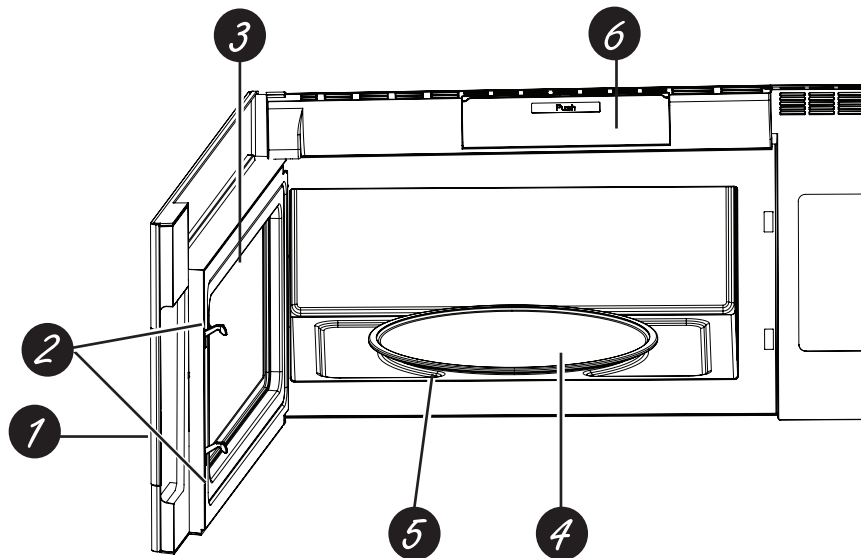

**1. Door Handle**

**2. Door Latches**

**3. Window with Metal Shield**

Screen allows cooking to be viewed while keeping microwaves confined in the oven.

**4. Removable Turntable**

Do not operate the oven in the microwave mode without the turntable and turntable support seated and in place.

**5. Removable Turntable Support**

Do not operate the oven in the microwave mode without the turntable and turntable support seated and in place.

**6. Charcoal Filter Cover**

Push the cover to replace the charcoal filter without taking the unit off from cabinet.

## Accessories

Bump-Out Kits

JX15BUMPWW—White

JX15BUMPBB—Black

# About the features

## Cooking Controls

1 Express Cook

1	2	3	4	5	Cook Time	Power Level	Add 30 Sec	Start/Pause
6	7	8	9	0	Timer On/Off	Vent Fan	Surface Light	Cancel Off

2 Sensor Cooking

Auto Cook	Reheat	Defrost	Steam Clean	Settings	Chef Connect
Steam Cook	Potato	Popcorn	Reset Filter	Lock Control	WiFi Connect
			Hold 3 Sec	Hold 3 Sec	Hold 3 Sec

Check the Convenience Guide before you begin.

1 Time Features

Press	Enter
COOK TIME	Amount of cooking time
DEFROST	Weight or time
TIMER	
POWER LEVEL	Power level 1 to 10
ADD 30 SEC	Starts immediately!
EXPRESS COOK	Starts immediately!

2 Sensor/Convenience Features

Press	Enter
AUTO COOK	Press pad to select food
POPCORN	Start immediately
REHEAT	Press pad to select food
POTATO	Start immediately
STEAM COOK	Press pad to select food

# About the features

## Cook Time

Allows you to microwave for any time up to 99 minutes and 99 seconds.

**Power level 10 (HIGH)** is automatically set, but you may change it for more flexibility.

1. Press **Cook Time**.
2. Enter cooking time.
3. Press **START**.

Cooking will start when the countdown begins in the display.

You may open the door during **Cook Time** to check the food. Close the door and press **START** to resume cooking.

Cook Time

Express Cook



Start  
Pause

## Express Cook

This is a quick way to set cooking time for 1-5 minutes.

1. Press one of the **Express Cook** pads (from 1-5) for 1-5 minutes of cooking at **power level 10**.  
For example, press the **2** pad for 2 minutes of cooking time.

The power level can be changed as time is counting down. Press **POWER LEVEL** and enter 1-10.

**NOTE: Express Cook function pertains to pads 1-5 only.**

Express Cook



## Add 30 Sec

This will add 30 seconds to the time counting down each time the pad is pressed. Each touch will add 30 seconds, up to 99 minutes and 99 seconds.

**Add 30 sec** can also be used like an express 30 seconds button. The microwave oven will start immediately when pressed.

Add  
30 Sec

## Weight Defrost

Use **Weight Defrost** for meat, poultry and fish. Use **Time Defrost** for most other frozen foods. (Time Defrost is explained on page 9.)

1. Press **DEFROST** once for **Weight Defrost**.
2. Enter the weight in pounds.
3. Press **START**.

Cooking will start when the countdown begins in the display.

Defrost

Express Cook



Start  
Pause

## Defrosting Tips

- Remove meat from package and place on microwave-safe dish.
- When the oven signals, turn the food over. Remove defrosted meat or shield warm areas with small pieces of foil.
- After defrosting, most meats need to stand 5 minutes to complete defrosting. Large roasts should stand for about 30 minutes.

## Conversion Guide

If the weight of food is stated in pounds and ounces, the ounces must be converted to tenths (.1) of a pound.

Ounces	Pounds
1-2	.1
3	.2
4-5	.3
6-7	.4
8	.5
9-10	.6
11	.7
12-13	.8
14-15	.9



# About the features

## Time Defrost

Allows you to defrost for a selected length of time. See the Defrosting Guide on page 14 for suggested times (**Weight Defrost** is explained on page 8).

1. Press **DEFROST** twice for **Time Defrost**.
2. Enter defrosting time in minutes and seconds.
3. Press **START**.  
Cooking will start when the countdown begins in the display.

At one half of selected defrosting time, turn food over and break apart or rearrange pieces for more even defrosting. Shield any warm areas with small pieces of foil. The oven will continue to defrost if you don't open the door and turn the food.

Noises may be heard during defrosting. This is normal when oven is not operating at **High** power.

## Defrosting Tips

- Foods frozen in paper or plastic can be defrosted in the package. Closed packages should be slit, pierced or vented **AFTER** food has partially defrosted. Plastic storage containers should be partially uncovered.
- Family-size, prepackaged frozen dinners can be defrosted and microwaved. If the food is in a foil container, transfer it to a microwave-safe dish.
- Foods that spoil easily should not be allowed to sit out for more than one hour after defrosting. Room temperature promotes the growth of harmful bacteria.
- For more even defrosting of larger foods, such as roasts, use **Time Defrost**. Be sure large meats are completely defrosted before cooking.
- When defrosted, food should be cool but softened in all areas. If still slightly icy, return to the microwave very briefly, or let it stand a few minutes.



## About the features

### Defrosting Guide

Food	Time	Comments
<b>Breads, Cakes</b>		
Bread, buns or rolls (1 piece)	1/4 min.	
Sweet rolls (approx. 12 oz.)	2 to 4 min.	Rearrange after half of time.
<b>Fish and Seafood</b>		
Fillets, frozen (1 lb.)	6 to 9 min.	
Shellfish, small pieces (1 lb.)	3 to 7 min.	Place block in casserole. Turn over and break up after first half of time.
<b>Fruit</b>		
Plastic pouch—1 or 2 (10-oz. package)	1 to 5 min.	
<b>Meat</b>		
Bacon (1 lb.)	2 to 5 min.	Place unopened package in oven. Let stand 5 minutes after defrosting.
Franks (1 lb.)	2 to 5 min.	Place unopened package in oven. Microwave just until franks can be separated. Let stand 5 minutes, if necessary, to complete defrosting.
Ground meat (1 lb.)	4 to 6 min.	Turn meat over after first half of time.
Roast: beef, lamb, veal, pork	9 to 12 min. per lb.	Use power level Warm (1).
Steaks, chops and outlets	4 to 8 min. per lb.	Place unwrapped meat in cooking dish. Turn over after first half of time and shield warm areas with foil. After second half of time, separate pieces with table knife. Let stand to complete defrosting.
<b>Poultry</b>		
Chicken, broiler-fryer, cut up (2 <sup>1</sup> / <sub>2</sub> to 3 lbs.)	14 to 19 min.	Place wrapped chicken in dish. Unwrap and turn over after first half of time. After second half of time, separate pieces and place in cooking dish. Microwave 2 to 4 minutes more, if necessary. Let stand a few minutes to finish defrosting.
Chicken, whole (2 <sup>1</sup> / <sub>2</sub> to 3 lbs.)	20 to 24 min.	Place wrapped chicken in dish. After first half of time, unwrap and turn chicken over. Shield warm areas with foil. To complete defrosting, run cool water in cavity until giblets can be removed.
Cornish hen	7 to 12 min. per lb.	Place unwrapped hen in oven breast-side-up. Turn over after first half of time. Run cool water in cavity until giblets can be removed.
Turkey breast (4 to 6 lbs.)	3 to 8 min. per lb.	Place unwrapped breast in microwave-safe dish breast-side-down. After first half of time, turn breast-side-up and shield warm areas with foil. Defrost for second half of time. Let stand 1 to 2 hours in refrigerator to complete defrosting.

# About the features

The Sensor Features detect the increasing humidity released during cooking. The oven automatically adjust the cooking time to various types and amounts of food.

Do not use the Sensor Features twice in succession on the same food portion - It may result in severely overcooked or burnt food. Be sure to let the oven cool down for 5 - 10 minutes before starting the next sensor cook.

If food is undercooked after the countdown, use Cook Time for additional cooking time

- The proper containers and covers are essential for best sensor cooking.
- **Always use microwave-safe containers and cover them with lids or vented plastic wrap. Never use tight-sealing plastic covers** - they can prevent steam from escaping and cause food to overcook.
- **Be sure the outside of the cooking container and the inside of the microwave oven are dry** before placing food in the oven. Beads of moisture turning into steam can mislead the sensor.

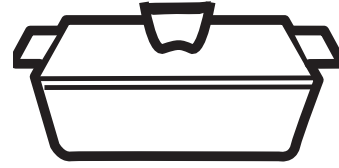

Covered



Vented



Dry off dishes so they don't mislead the sensor.

## How to Change the Automatic Settings

### To reduce time by 10%:

Press 1 after the feature pad.

### To add 10% to cooking time:

Press 9 after the feature pad.

## Auto Cook

Allows you to microwave food choices with sensor.

1. Press **AUTO COOK** button.
2. Enter the food type code. See Cooking Guide for AUTO COOK below for codes or check the display for food types..

### 2. Press **START**.

The oven signals when steam is sensed and the time remaining begins counting down.

Do not open the oven door until time is counting down. If the door is opened before time is counting down 4 beeps are emitted while the display will Scroll & Cycle "SENSOR ERROR " until **CANCEL** is pressed. The sensor cook will be cancelled as well. If the Door is opened during the counting down, close it and press **START** immediately.

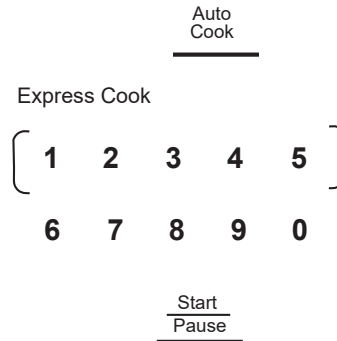

### Cooking Guide for Auto Cook Feature

CODE ENTRY	FOOD	COMMENTS
1	Chicken	
2	Fish	
3	Ground Meat	
4	Veggies	Enter veggies type 1 Fresh Veggies 2 Frozen Veggies 3 Canned Veggies

# About the features

---

## Popcorn

To use the **Popcorn** feature:

1. Place the package of popcorn in the center of the microwave.
2. Press **POPCORN**. The oven starts immediately.  
Your popcorn bag may get stuck and stop rotating, but this will not affect the cooking performance. Do not open the door even if the bag is not rotating.  
Using the vent function in combination with the popcorn sensor feature may lead to over cooking.

## Popcorn

---

### How to Change the Automatic Settings

#### To reduce time by 10%:

Press 1 after the feature pad.

#### To add 10% to cooking time:

Press 9 after the feature pad.

If food is undercooked after the countdown, use **Cook Time** for additional cooking time. We recommend 30 seconds and watch carefully.

## Reheat

The **Reheat** feature reheats servings of previously cooked foods or a plate of leftovers.

1. Press **REHEAT**.
2. Using the cooking guide below, enter food code. For example, **1** for Pasta.
3. Press **START/PAUSE**. The oven signals when steam is sensed and the time remaining begins counting down.

Do not open the oven door until time is counting down. If the door is opened before time is counting down 4 beeps are emitted while the display will Scroll & Cycle "SENSOR ERROR " until **CANCEL** is pressed. The sensor cook will be cancelled as well. If the Door is opened during the counting down, close it and press **START** immediately.

## Reheat

---

**After removing food from the oven, stir, if possible, to even out the temperature. If the food is not hot enough, use Cook Time to reheat for more time. Reheated foods may have wide variations in temperature. Some areas may be extremely hot.**

It is best to use **Cook Time** for these foods:

- Bread products.
- Foods that must be reheated covered.
- Foods that need to be stirred or rotated during reheating.
- Foods calling for a dry look or crisp surface after reheating.

### How to Change the Automatic Settings

#### To reduce time by 10%:

Press 1 after the feature pad.

#### To add 10% to cooking time:

Press 9 after the feature pad.

#### Cooking Guide for Reheat Feature:

Code Entry	Food
1	Pasta
2	Pizza
3	Plate
4	Soup

## Potato

To use the **Potato** feature:

1. Place the potato in the center of the microwave.
2. Press **POTATO**.

The oven starts immediately.

Do not open the oven door until time is counting down. If the door is opened before time is counting down 4 beeps are emitted while the display will Scroll & Cycle "SENSOR ERROR " until **CANCEL** is pressed. The sensor cook will be cancelled as well. If the Door is opened during the counting down, close it and press **START** immediately.

## Potato

---

### How to Change the Automatic Settings

#### To reduce time by 10%:

Press 1 after the feature pad.

#### To add 10% to cooking time:

Press 9 after the feature pad.

# About the features

## Microwave Terms

Term	Definition
<b>Arcing</b>	Arcing is the microwave term for sparks in the oven. Arcing is caused by: <ul style="list-style-type: none"> <li>• metal or foil touching the side of the oven.</li> <li>• foil that is not molded to food (upturned edges act like antennas).</li> <li>• metal such as twist-ties, poultry pins, gold-rimmed dishes.</li> <li>• recycled paper towels containing small metal pieces.</li> </ul>
<b>Covering</b>	Covers hold in moisture, allow for more even heating and reduce cooking time. Venting plastic wrap or covering with wax paper allows excess steam to escape.
<b>Shielding</b>	In a regular oven, you shield chicken breasts or baked foods to prevent over-browning. When microwaving, you use small strips of foil to shield thin parts, such as the tips of wings and legs on poultry, which would cook before larger parts.
<b>Standing Time</b>	When you cook with regular ovens, foods such as roasts or cakes are allowed to stand to finish cooking or to set. Standing time is especially important in microwave cooking. Note that a microwaved cake is not placed on a cooling rack.
<b>Venting</b>	After covering a dish with plastic wrap, vent the plastic wrap by turning back one corner so excess steam can escape.

## Steam Cook

Use the **Steam Cook** feature to steam certain preprogrammed foods.

1. Press **Steam Cook** button.
2. Enter the food type code you wish to Steam Cook. See Cooking Guide for Steam Cook below for codes or check the display for food types.
3. Place steamer bowl with water, salt (if necessary), and food in the microwave with the steam vents on the steamer bowl in the OPEN position.
4. Press **START** button to begin cooking.

**NOTE:** The NordicWare Rice Cooker/Steamer Bowl should be used for best cooking results.

## Cooking Guide for Steam Cook Feature

Code Entry	Food	Amount Entry
1	Rice	1 - 1 cup white 2 - 1 cup brown
2	Asparagus	1 - 1 cup 2 - 2 cups
3	Broccoli	1 - 1 cup 2 - 2 cups
4	Brussel Sprouts	1 - 1 cup 2 - 2 cups
5	Carrots	1 - 1 cup 2 - 2 cups
6	Cauliflower	1 - 1 cup 2 - 2 cups
7	Zucchini	1 - 1 cup 2 - 2 cups

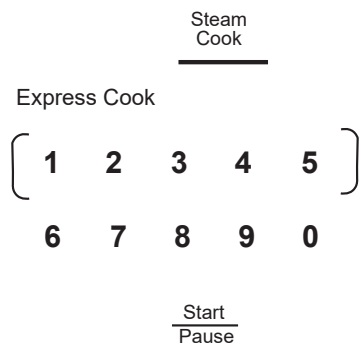

# About the features

## Changing the Power Level

The power level may be entered or changed before or during cooking. **Power Level** is set for Level 10 (High) unless it is changed.

1. Press **Power Level** button.
2. Enter new power level by using the number pads or press the **Power Level** button multiple times until you find the level you want.
3. After you have selected the power level, wait five seconds. The display will go back to the **Cook Time** screen.
4. Enter cooking time and press **START**.

OR

1. Press **Cook Time** button.
2. Enter your cooking time.
3. Press **Power Level** button.
4. Enter new power level by using the number pads or press the **Power Level** button multiple times until you find the level you want.
5. After you have selected the power level, wait five seconds. The display will go back to the **Cook Time (Enter Time)** screen.
6. Press **START**.

Variable power levels add flexibility to microwave cooking. The power levels on the microwave oven can be compared to the surface units on a range. Each power level gives you microwave energy a certain percent of the time. **Power level 7** is microwave energy 70% of the time. **Power level 3** is energy 30% of the time. Most cooking will be done on High (power level 10) which gives you 100% power. **Power level 10** will cook faster but food may need more frequent stirring, rotating or turning over. A lower setting will cook more evenly and need less stirring or rotating of the food. Some foods may have better flavor, texture or appearance if one of the lower settings is used. Use a lower power level when cooking foods that have a tendency to boil over, such as scalloped potatoes and some casseroles.

Rest periods (when the microwave energy cycles off) give time for the food to “equalize” or transfer heat to the inside of the food. An example of this is shown with **Power level 3**—the defrost cycle. If microwave energy did not cycle off, the outside of the food would cook before the inside was defrosted.

Here are some examples of uses for various power levels:

**High 10 (100%):** Fish, bacon, vegetables, boiling liquids.

**Med-High 7 (70%):** Gentle cooking of meat and poultry; baking casseroles and reheating.

**Medium 5 (50%):** Slow cooking and tenderizing for stews and less tender cuts of meat.

**Low 2 or 3 (20 or 30%):** Defrosting; simmering; delicate sauces.

**Warm 1 (10%):** Keeping food warm; softening butter.

**NOTE:** You can also change the power level during many cooking modes by pressing the power level button entering a valid power level.

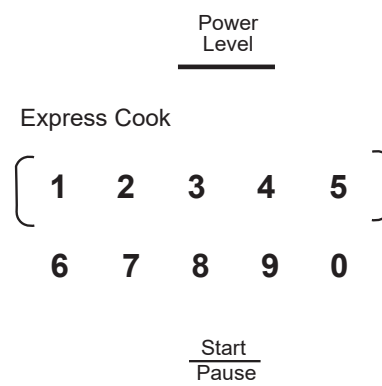

# Other Features

---

## Start/Pause

In addition to starting many functions, **START/PAUSE** allows you to stop cooking without opening the door or clearing the display and resume cooking later.

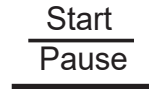

---

## Cancel/Off

Press the **CANCEL/OFF** button to stop and cancel cooking at any time.



---

## Control Lock-Out

You may lock the control panel to prevent the oven from being accidentally started during cleaning or being used by children.

To lock or unlock the controls, press and hold the **LOCK CONTROL** button for three seconds. When the control panel is locked, LOCKED will be displayed briefly anytime a button or dial is pressed. "L" will show in the display.



---

## Surface Light

Press **SURFACE LIGHT** once for low light, twice for high light or a third time to turn the light off.

**Note:** If the microwave is working and the vent fan is on Boost speed, the surface lights will be turned to low light automatically.



---

## Timer

**NOTE:** The **Timer** indicator will be lit while the timer is operating.

The **Timer** operates as a minute timer and can be used at any time, even when the oven is operating.

1. Press the **Timer** button.
2. Enter a time.
3. Press the **Timer** button to start.

To cancel, press the **Timer** button.

When time is up, the oven will signal.  
To turn off the timer signal, press **Timer**.

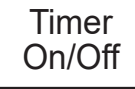

# Other Features

## Steam Clean

1. Press the **Steam Clean** button.
2. Put steam bowl with 1/4 cup of water.
3. Press the dial or **Start/Pause** to start.

Once the cycle is terminated, wipe oven cavity with paper towel or cloth.

Steam  
Clean

---

## Display

If you have the Timer counting down and you are using the Cook Time at the same time, you can change the display to show either the timer or the cook time countdown.

If the display shows the time for the Timer and you would like to view the Cook Time, press the **COOK TIME** button.

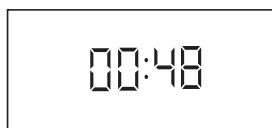

If the display shows the time for the Cook Time and you would like to view the Timer, press the **TIMER** button

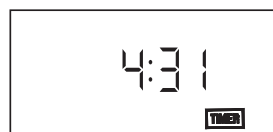

## WiFi Connect

Empowers you to remotely monitor and control your microwave oven using your smart phone or tablet. For example, you could view the current status of the microwave or turn it on and off. To get started, download and open the Café Appliances Kitchen App using your smart device. To enable this feature, follow the instructions provided in the app. To disable this feature and remove the microwave from the WiFi network, press and hold the WiFi Connect button for 3 seconds. You

have successfully disabled this feature when the WiFi icon in the display is no longer illuminated. For further instructions, visit our website at [cafeappliances.com/connect](http://cafeappliances.com/connect).

WiFi  
Connect  
— Hold 3 Sec —

## Vent Fan

The vent fan removes steam and other vapors from surface cooking.

Press **Vent Fan** once for low fan speed, twice for medium fan speed, three times for high fan speed, four times for boost speed or five times to turn the fan off

### Automatic Fan

An automatic fan feature protects the microwave from too much heat rising from the cooktop below it. It automatically turns on if it senses too much heat.

If you have turned the fan on you may find that you cannot turn it off. The fan will automatically turn off when the internal parts are cool. It may stay on for 30 minutes or more after the cooktop and microwave controls are turned off.

Vent  
Fan

---

## Insert Food Reminder

A reminder will show on the display if the user tries to start the cooking cycle without placing food inside the microwave oven within 5 minutes prior to starting the cooking cycle.

## Cooking Complete Reminder

To remind you that you have food in the oven, the oven will display "Food is ready" and beep once a minute until you either open the oven door or press the **CANCEL/OFF** button.



# Other Features

## Settings

Settings allow to change the default settings of your OTR.

1. Press the Settings pad. "SELECT SETTING ITEM"

- 1- CLOCK SETTING
- 2- CLOCK MODE
- 3- BEEPER VOLUME
- 4- LIGHT SYNC
- 5- VENT FAN SYNC
- 6- SYNC SUTO OFF

- 7- TURN TABLE
- 8- DISPLAY SETTING
- 9- REMOTE ENABLE
- 0- EXIT

2. Select the item to change the settings. See below tables for detail Guide

## Settings



Code Entry	Items for setting	Level Entry
1	CLOCK Setting	Entry valid number for setting clock time
2	Clock Mode	0 - 12 hours 1 - 24 hours Default is 12 hours
3	Beeper Volume	0 - Mute 1 - Low 2 - Normal 3 - Loud Default is normal
4	Chef Connect Feature: Light Sync - Selects the light level at which the surface lights will automatically turn on when paired range's burner is turned on. Select "Off" to disable this feature. Surface light will turn on manually.	0 - Off 1 - Low 2 - High Default is High
5	Chef Connect Feature: Vent Fan Sync - Selects the fan speed at which the vent fan will automatically turn on when paired range's burner is turned on. Select "Off" to disable this feature. Vent fan will turn on manually.	0 - Off 1 - Low 2 - Medium 3 - High 4 - Boost Default is OFF
6	Chef Connect Feature: Sync Auto Off - When the Light/Vent fan sync mode is enabled (ON), this will automatically turn OFF the light/fan when the range burner has been turned off. Select the period of time the light/fan will remain on until the microwave automatically turns it off.	0 - 0 minutes 1 - 5 minutes 2 - 10 minutes 3 - 15 minutes 4 - Manual Default is 15 minutes
7	Turntable On/Off	0 - OFF 1 - ON default setting is ON"
8	Display Setting	DISPLAY: 1 - DISPLAY ON/OFF : 0 - OFF 1 - ON 2 - SCROLL SPEED : 1 - SLOW 2 - NORMAL 3 - FAST 3 - SLEEP DELAY: 1 - 5 SEC 2 - 10 SEC 3 - 30 SEC
9	Remote Enable: Remote Enable On/Off feature could enable you to start the microwave from a remote source or avoid you unintendedly to control your microwave remotely. For turn on/off this feature please press "Settings" button on the control panel then press "9" to select this feature then press "1" for On and "0" for Off function.	0-OFF 1-ON Default is On
0	Setting Exit	0 - EXIT

## Other Features

---

### Chef Connect

Use the Chef Connect feature for connecting your microwave to a GE Appliances range to sync your vent fan, cooktop surface lights and clock via Bluetooth technology.

1. You must have a Chef Connect enabled range. To pair your microwave for the first time, initiate the Chef Connect process on the GE Appliances range. Refer to the range owner's manual for instructions
2. On the microwave, hold Chef Connect button for 3 seconds. The Bluetooth icon  on the display will start flashing as the microwave starts to search and pair with your GE Appliances range. The icon  will remain ON after pairing successfully.

If a GE Appliances range is not found within 2 minutes during search mode the microwave will stop searching and the Bluetooth icon  will turn OFF.

On initial setup, the setup protocol will start.

If the Chef Connect feature is enabled the default settings are as follows:

- Display clock sync: ON
- Auto cooktop light: ON (HIGH setting)
- Auto vent fan: OFF
- Auto off: 15 minutes

3. Select 1 to sync the surface lights to your GE Appliances range. It allows the microwave surface lights to turn on at HIGH level automatically when the paired range's cooktop burner turns on.

4. Select 1 to sync the vent fan to your GE Appliances range. This allows the microwave vent fan to turn on at LOW speed automatically when the paired range's cooktop burner turns on.

Pairing is now complete, the Chef Connect feature is now on.

**NOTE:** If there is no sync option selected during set up, 5 minutes after icon  turns on, the units will return to stand-by mode.

After completing the setting per above steps, your microwaves vent fan and cooktop light will be set to turn on automatically when the cooktop burner is turned on. The cooktop and range clock display will be synced to display the same time. The vent fan and cooktop light will be set to automatically turn off 15 minutes after the cooktop burner is turned off.

If desired, the light, fan, and auto off settings can now be changed using settings options 4, 5, and 6, respectively.

Press Chef Connect once to turn off and twice to re-connect. The icon  will illuminate when on.

In the case of an unintended disconnect such as lost power to the microwave or range the connection will remain after power resumed. For very short power interruptions, the power may need to be reset in order to reconnect

Chef  
Connect

---

Hold 3 Sec

# Other Features

## Reset Filter

The red LED indicator will light every 6 months as a reminder to replace the charcoal filter.

After replacing the charcoal filters, Hold the **Reset Filter** for 3 seconds to turn off the Red LED indicator.

Reset  
Filter

Hold 3 Sec

## Charcoal Filter

The charcoal filter cannot be cleaned. It must be replaced. Order Part No. WB02X11550 from your GE supplier.

If the model is not vented to the outside, the air will be recirculated through a disposable charcoal filter that helps remove smoke and odors.

The charcoal filter should be replaced when the red LED indicator lights under the **Reset Filter** pad. See "Optional Kits," page 8, for more information.

## To Remove The Charcoal Filter

To remove the charcoal filter, first disconnect power at the main fuse or circuit breaker, or pull the plug. Open the microwave oven door and push the "Push" area on charcoal filter cover at center of the grille. Press back on the top of the filter with both hands until the filter lays down almost horizontal. Lift the filter at the bottom until it comes free of the tabs. Slide the filter down and out.

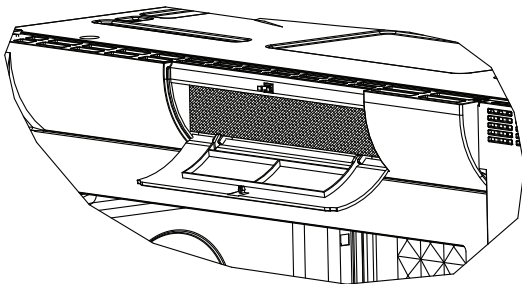
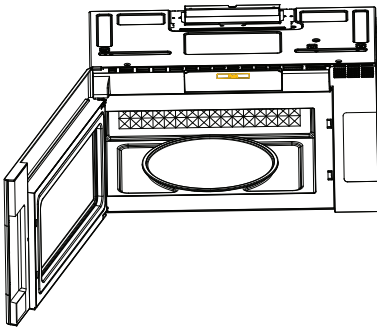

## To Install the Charcoal Filter

To install a new charcoal filter, remove plastic and other outer wrapping from the new filter.

Insert the top of the filter up and into the grooves on both sides of the inside of the top opening. Once you have cleared the bottom tab, push the bottom of the filter in until it rests in place vertically behind the tab.

Close the charcoal filter cover at center of the grille by pushing the "Push" area again.

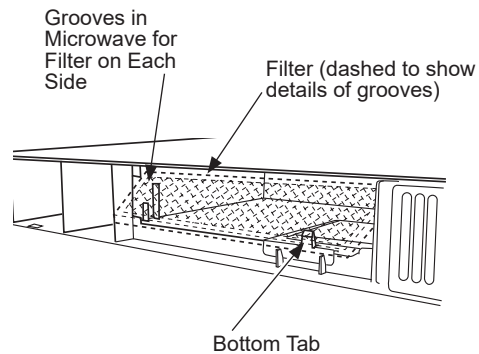

How to install charcoal filter, here is video instruction. <http://www.geappliances.com/videos/microwave-troubleshooting-fix.htm>



## WiFi Connect

### Connecting your WiFi Connect enabled microwave oven (on some models)

Your Café Appliances microwave oven is designed to provide you with two-way communication between your appliance and smart device. By using the Café Appliances WiFi Connect features, you will be able to control essential operations such as turning on and off your microwave, convenience features, cook time, timers using your smartphone, tablet or voice control device.

#### What you will need:

1. Know the password of your home WiFi router.
2. Download the Café Appliances Kitchen App to your smart device.
3. Follow the app on-screen instructions to connect your Café microwave.

For further instructions, visit:

[cafeappliances.com/connect](http://cafeappliances.com/connect).



## Remote Enable On/Off Feature

Remote Enable is a feature that allows you to start the microwave from a remote source such as the Café Appliances Kitchen App or Voice Commands from Amazon Alexa or Google Assistant.

When the Remote Enable feature is off, you will still receive messages from your microwave, you can turn off the microwave, or you can use the timer and clock from your smart device.

When the Remote Enable feature is on, you need to have opened the microwave door within the last 5 minutes. The 5 minute restriction is to help ensure food is in the microwave before starting the cooking cycle.

To turn this feature on/off select the Settings button on the control panel and then press “9” to select this feature. Press “1” for Remote Enable On and “0” for Remote Enable Off.

### Settings

## Remote Enable Equipment

This device complies with part 15 of the FCC Rules. Operation is subject to the following two conditions: (1) This device may not cause harmful interference, and (2) this device must accept any interference received, including interference that may cause undesired operation.

The wireless communication equipment installed on this microwave has been tested and found to comply with the limits for a Class B digital device, pursuant to part 15 of the FCC Rules. These limits are designed to:

(a) provide reasonable protection against harmful interference in a residential installation. This equipment generates, uses, and can radiate radio frequency energy and, if not installed and used in accordance with the instructions, may cause harmful interference to radio communications. However, there is no guarantee that interference will not occur in a particular installation. If this equipment does cause harmful interference to radio or television reception, which can be determined by turning the equipment off and on, the user is encouraged to try to correct the interference by one or more of the following measures:

- Reorient or relocate the receiving antenna.
- Increase the separation between the equipment and receiver.

- Connect the equipment into an outlet on a circuit different from that to which the receiver is connected.
- Consult the dealer or an experienced radio/TV technician for help.

(b) accept any interference received, including interference that may cause undesired operation of the device.

**NOTE:** Any changes or modifications to the wireless communication device installed on this oven that are not expressly approved by the manufacturer could void the user’s authority to operate the equipment.

RF Exposure - This device is only authorized for use in a mobile application. At least 20 cm of separation distance between the transmitting antenna device and the user’s body must be maintained at all times.

# Care and Cleaning

## Helpful Hints

An occasional thorough wiping with a solution of baking soda and water keeps the inside fresh.

**Be certain the oven control is turned off before cleaning any part of this oven.**



## How to Clean the Inside

### Walls, Floor, Inside Window, Metal and Plastic Parts on the Door

Some spatters can be removed with a paper towel; others may require a damp cloth. Remove greasy spatters with a sudsy cloth, then rinse with a damp cloth. Do not use abrasive cleaners or sharp utensils on oven walls.

To clean the surface of the door and the surface of the oven that come together upon closing, use only mild, nonabrasive soaps or detergents using a sponge or soft cloth. Rinse with a damp cloth and dry.

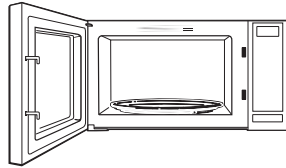

Never use a commercial oven cleaner on any part of your microwave.

### Removable Turntable and Turntable Support

To prevent breakage, do not place the turntable into water just after cooking. Wash it carefully in warm, sudsy water or in the dishwasher. The turntable and support can be broken if dropped. Remember, do not operate the oven in the microwave mode without the turntable and support seated and in place.

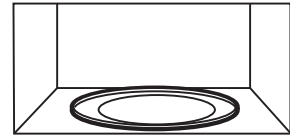

## How to Clean the Outside

Do not use cleaners containing ammonia or alcohol on the microwave oven. Ammonia or alcohol can damage the appearance of the microwave.

### Case

Clean the outside of the microwave with a sudsy cloth. Rinse with a damp cloth and then dry. Wipe the window clean with a damp cloth.

### Control Panel and Door

Wipe with a damp cloth. Dry thoroughly. Do not use cleaning sprays, large amounts of soap and water, abrasives or sharp objects on the panel—they can damage it. Some paper towels can also scratch the control panel.

### Door Surface

It is important to keep the area clean where the door seals against the microwave. Use only mild, non-abrasive detergents applied with a clean sponge or soft cloth. Rinse well.

### Power Cord

If the cord becomes soiled, unplug and wash with a damp cloth. For stubborn spots, sudsy water may be used, but be certain to rinse with a damp cloth and dry thoroughly before plugging cord into outlet.

### Stainless Steel (on some models)

Do not use a steel-wood pad; it will scratch the surface.

To clean the stainless steel surface, use a hot, damp cloth with a mild detergent suitable for stainless steel surfaces. Use a clean, hot, damp cloth to remove soap. Dry with a dry, clean cloth. Always scrub lightly in the direction of the grain.

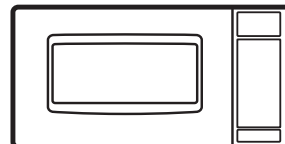

## Care and Cleaning

### Removing and Cleaning the Filters

To **remove**, slide them to the rear using the tabs. Pull down and out.

To clean the vent filters, soak them and then swish around in hot water and detergent. Don't use ammonia or ammonia products because they will darken the metal. Light brushing can be used to remove embedded dirt.

Rinse, shake and let dry before replacing.

To **replace**, slide the filters into the frame slots on the back of each opening. Press up and to the front to lock into place.

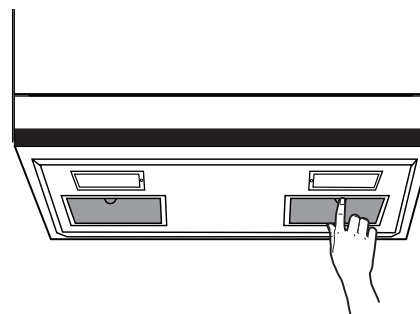

### Cooktop Lights/Nite Lights

Replace with **DC12 volt, 1.2 watt LED lights. Order WB25X33469 from your Café supplier.**

1. To replace the cooktop lights/nite lights, first disconnect the power at the main fuse or circuit breaker panel, or pull the plug.
  2. One side at a time, remove the screw from the side of the light compartment cover and lower the cover until it stops.
  3. Be sure the LED light is cool before removing. Gently remove the LED wiring connector from LED board.
  4. Replace with the new LED board and insert the wiring plug, then raise the light cover and replace the screw.
- Repeat for the other light. Connect electrical power to the oven.

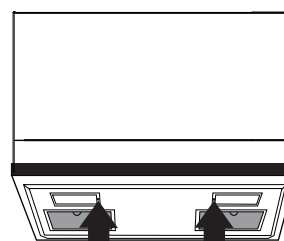

Remove screws.

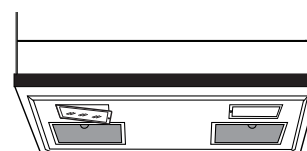

### Replacing the Oven Cavity Light

1. Disconnect power at the main fuse or circuit breaker panel.
2. Press the charcoal access door at the top to open
3. Remove charcoal filter if present. **NOTE:** Charcoal filter is an optional kit, you may not have one.
4. Press the retainer holding the lamp shield in place.
5. Pull the lamp shield out. Unscrew the LED light out and replace with the new LED board. Order WB25X33469 from your Café supplier.
6. Return the lamp and lamp shield to original position and replace charcoal filter.
7. Replace the grill and 2 screws. Reconnect power to the oven.

### Vent Fan

The vent fan has two metal reusable vent filters.

Models that recirculate air back into the room also use a charcoal filter.

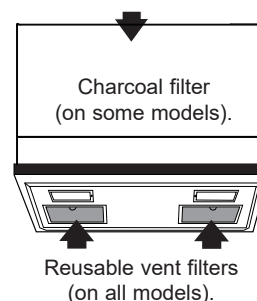

### Reusable Vent Filters

The metal filters trap grease released by foods on the cooktop. They also prevent flames from foods on the cooktop from damaging the inside of the oven.

For this reason, the filters must always be in place when the hood is used. The vent filters should be cleaned once a month, or as needed.

# Troubleshooting Tips

## Things That Are Normal With Your Microwave Oven

- Steam or vapor escaping from around the door.
- Light reflection around door or outer case.
- Dimming oven light and change in the blower sound at power levels other than high.
- Dull thumping sound while oven is operating.
- TV-radio interference might be noticed while using the microwave. Similar to the interference caused by other small appliances, it does not indicate a problem with the microwave. Plug the microwave into a different electrical circuit, move the radio or TV as far away from the microwave as possible or check the position and signal of the TV/radio antenna.

### FEDERAL COMMUNICATIONS COMMISSION RADIO FREQUENCY INTERFERENCE STATEMENT (U.S.A. ONLY)

This equipment generates and uses ISM frequency energy and if not installed and used properly, that is in strict accordance with the manufacturer's instructions, may cause interference to radio and television reception. It has been type tested and found to comply with limits for ISM Equipment pursuant to part 18 of FCC Rules, which are designed to part 18 of FCC Rules, which are designed to provide residential installation.

However, there is no guarantee that interference will not occur in a particular installation. If this equipment does cause interference to radio or television reception, which can be determined by turning the equipment off and on, the user is encouraged to try to correct the interference by one or more of the following:

- Reorient the receiving antenna of the radio or

television.

- Relocate the Microwave Oven with respect to the receiver.
- Move the microwave oven away from the receiver.
- Plug the microwave oven into a different outlet so that the microwave oven and the receiver are on different branch codes.

The manufacturer is not responsible for any radio or TV interference caused by unauthorized modification to this microwave oven. It is the responsibility of the user to correct such interference.

## Troubleshooting Tips... Before you schedule service

Save time and money! Review the charts on the following pages first and you may not need to schedule service.

Problem	Possible Causes	What To Do
Oven will not start	A fuse in your home may be blown or the circuit breaker tripped.	Replace fuse or reset circuit breaker.
	Power surge.	Unplug the microwave oven, then plug it back in.
	Plug not fully inserted into wall outlet.	Make sure the 3-prong plug on the oven is fully inserted into wall outlet.
	Door not securely closed.	Open the door and close securely.
Control panel lighted, yet oven will not start	Door not securely closed.	Open the door and close securely.
	START button not pressed after entering cooking selection.	Press <b>START</b> .
	Another selection entered already in oven and OFF/CLEAR button not pressed to cancel it.	Press <b>OFF/CLEAR</b> .
	Cooking time not entered after pressing TIME COOK.	Make sure you have entered cooking time after pressing <b>TIME COOK</b> .
	OFF/CLEAR was pressed accidentally.	Reset cooking program and press <b>START</b> .
	Food weight not entered after selecting AUTO DEFROST.	Make sure you have entered food weight after selecting <b>AUTO DEFROST</b> .
	Food type not entered after pressing COOK.	Make sure you have entered a food type.
CONTROL LOCKED appears on display	The control has been locked.	Press and hold <b>OFF/CLEAR</b> for about 3 seconds to unlock the control.
HOT appears on display	The temperature inside the oven is greater than 200°F.	This is normal.
	One of the sensor cooking pads was pressed when the temperature inside the oven was greater than 200°F.	These features will not operate when the oven is hot.



# Café Microwave Oven Limited Warranty

**LIMITED WARRANTY**

## cafeappliances.com

All warranty service is provided by our Factory Service Centers, or an authorized service technician. To schedule service online, visit us at [cafeappliances.com/service](http://cafeappliances.com/service). Please have your serial number and your model number available when scheduling service.

For the period of	Café will replace
<b>One year</b> From the date of the original purchase	Café <b>will choose to replace or service</b> the defective unit. <i>In the event of service, Café will provide</i> any part of the microwave oven which fails due to a defect in materials or workmanship. During this <b>limited one-year warranty</b> , GE Appliances will also provide, free of charge, all labor and related service costs to replace the defective part when the unit is serviced.
<b>Five year</b> From the date of the original Purchase	<b>For the period of Five Years from the date of the original purchase, Café will choose to either replace the unit or replace the magnetron tube, if the magnetron tube</b> fails due to a defect in materials or workmanship. During this <b>five –year limited warranty</b> , you will be responsible for any labor or in-home service cost.

### What Café will not cover:

- Service trips to your home to teach you how to use the product.
- Improper installation, delivery or maintenance. If you have an installation problem, contact your dealer or installer. You are responsible for providing adequate electrical, exhausting, and other connecting facilities.
- Failure of the product or damage to the product if it is abused, misused (for example, cavity arcing from wire rack or metal/foil), or used for other than the intended purpose or used commercially.
- Replacement of house fuses or resetting of circuit breakers.
- Damage to the product caused by accident, fire, floods, or acts of God.
- Damage to finish, such as surface rust, tarnish, or small blemishes not reported within 48 hours of delivery.
- Incidental or consequential damage caused by possible defects with this appliance.
- Damage caused after delivery.
- Product not accessible to provide required service.
- Service to repair or replace light bulbs, except for LED lamps.

### EXCLUSION OF IMPLIED WARRANTIES

Your sole and exclusive remedy is product repair as provided in this Limited Warranty. Any implied warranties, including the implied warranties of merchantability or fitness for a particular purpose, are limited to one year or the shortest period allowed by law.

This limited warranty is extended to the original purchaser and any succeeding owner for products purchased for home use within the USA. If the product is located in an area where service by a Café Authorized Servicer is not available, you may be responsible for a trip charge or you may be required to bring the product to an Authorized Café Service location for service. In Alaska, the limited warranty excludes the cost of shipping or service calls to your home. Some states do not allow the exclusion or limitation of incidental or consequential damages. This limited warranty gives you specific legal rights, and you may also have other rights which vary from state to state. To know what your legal rights are, consult your local or state consumer affairs office or your state's Attorney General.

**Warrantor: GE Appliances, a Haier company**  
 Louisville, KY 40225

**Extended Warranties:** Purchase a Café extended warranty and learn about special discounts that are available while your warranty is still in effect. You can purchase it online anytime at

[cafeappliances.com/extended-warranty](http://cafeappliances.com/extended-warranty)

Café Service will still be there after your warranty expires.

Staple your receipt here. Proof of the original purchase date is needed to obtain service under the warranty.

# Consumer Support

---

## Café Website

Have a question or need assistance with your appliance? Try the Café website 24 hours a day, any day of the year! You can also shop for more great Café products and take advantage of all our on-line support services designed for your convenience. In the US: [cafeappliances.com](http://cafeappliances.com)

---

## Register Your Appliance

Register your new appliance on-line at your convenience! Timely product registration will allow for enhanced communication and prompt service under the terms of your warranty, should the need arise. You may also mail in the pre-printed registration card included in the packing material. In the US: [cafeappliances.com/register](http://cafeappliances.com/register)  
In Canada: [cafeappliances.ca/registration](http://cafeappliances.ca/registration)

---

## Schedule Service

Expert Café repair service is only one step away from your door. Get on-line and schedule your service at your convenience any day of the year. In the US: [cafeappliances.com/service](http://cafeappliances.com/service)

---

## Extended Warranties

Purchase a Café extended warranty and learn about special discounts that are available while your warranty is still in effect. You can purchase it on-line anytime. Café Service will still be there after your warranty expires.  
In the US: [cafeappliances.com/extended-warranty](http://cafeappliances.com/extended-warranty)

---

## Remote Connectivity

For assistance with wireless network connectivity (for models with remote enable), visit our website at [cafeappliances.com/connect](http://cafeappliances.com/connect)

---

## Parts and Accessories

Individuals qualified to service their own appliances can have parts or accessories sent directly to their homes (VISA, MasterCard and Discover cards are accepted). Order on-line today 24 hours every day.  
In the US: [cafeappliances.com/parts](http://cafeappliances.com/parts)

**Instructions contained in this manual cover procedures to be performed by any user. Other servicing generally should be referred to qualified service personnel. Caution must be exercised, since improper servicing may cause unsafe operation.**

---

## Contact Us

If you are not satisfied with the service you receive from Café, contact us on our website with all the details including your phone number, or write to:

In the US: General Manager, Customer Relations | Café Appliances, Appliance Park | Louisville, KY 40225  
[cafeappliances.com/contact](http://cafeappliances.com/contact)