

# FRIGIDAIRE

All about the

# Use & Care

of your Electric Range

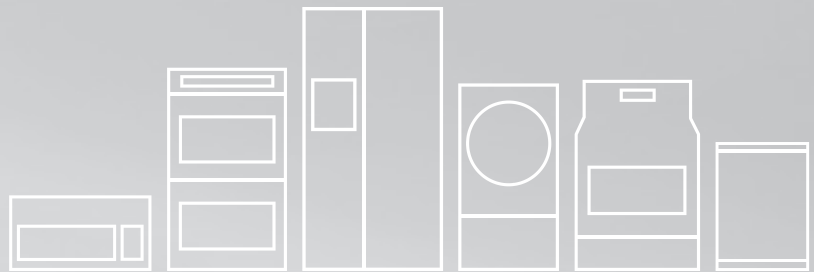

## TABLE OF CONTENTS

Important Safety Instructions.....	3-5	Setting Oven Controls.....	14-20
Before Setting Oven Controls .....	6-7	Clean .....	21-22
Before Setting Surface Controls .....	7-8	Care & Cleaning .....	23-26
Setting Surface Controls (Ceramic cooktop).....	9-12	Before You Call .....	27-29
Oven Control Functions (330i).....	13	Major Appliance Warranty .....	30

# PRODUCT RECORD AND REGISTRATION

## Contents

Product Registration .....	2
<b>Important Safety Instructions .....</b>	<b>3-5</b>
<b>Before Setting Oven Controls.....</b>	<b>6-7</b>
Removing, replacing & arranging racks .....	6
<b>Before Setting Surface Controls.....</b>	<b>7-8</b>
About the ceramic cooktop & radiant elements.....	7
Cookware material types.....	8
<b>Setting Surface Controls .....</b>	<b>9-12</b>
Single radiant surface elements.....	9
Dual radiant surface elements (some models) .....	10
Keep warm (some models) .....	11
Home canning .....	12
<b>Oven Controls Functions .....</b>	<b>13</b>
<b>Setting Oven Controls .....</b>	<b>14-20</b>
Setting the clock .....	14
Changing between continuous bake or 12-Hour	
Energy Saving features.....	14
Changing oven temperature display (F° or C°) .....	14
Setting silent control panel.....	14
Setting controls lock.....	15
Setting the minute timer.....	15
Setting bake .....	16
Setting bake time and start time features.....	16-17
Quick bake (some models).....	18
Setting broil.....	19
Adjusting oven temperature.....	20
Operating the oven light.....	20
<b>Clean.....</b>	<b>21-22</b>
<b>Care &amp; Cleaning.....</b>	<b>23-26</b>
Cleaning recommendations table.....	23
Cooktop maintenance & cleaning.....	24-25
Aluminum foil and oven liners .....	25
Replacing interior oven light.....	25
Removing & replacing oven door .....	26
<b>Before You Call</b>	
Solutions to common problems .....	27-29
<b>Appliance Warranty.....</b>	<b>31</b>

Thank you for choosing **Frigidaire**.

This Use & Care Guide is part of our commitment to customer satisfaction and product quality throughout the service life of your new appliance. We view your purchase as the beginning of a relationship. To ensure our ability to continue serving you, please use this page to record important product information.

## Need help??

**Visit the Frigidaire web site at [www.frigidaire.com](http://www.frigidaire.com)**

Before you call for service, there are a few things you can do to help us serve you better.

**Read this Use & Care manual.**

It contains instructions to help you use and maintain your range properly.

**If you received a damaged range ...**

immediately contact the dealer (or builder) that sold you the range.

**Save time and money.**

Check the section titled "Before You Call". This section helps step you through some common problems that might occur.

If you do need service, help is only a phone call away. Call Frigidaire Customer Services at **1-800-944-9044**.

## Product Registration

Registering your product with Frigidaire enhances our ability to serve you. You can register online at **www.frigidaire.com** or by dropping your Product Registration Card in the mail.

## Serial plate location



Serial plate location:  
open storage drawer (some models) or  
remove lower front panel (some models).

## Record model & serial numbers here

\_\_\_\_\_  
Purchase date

\_\_\_\_\_  
Model number

\_\_\_\_\_  
Serial number

## IMPORTANT SAFETY INSTRUCTIONS

### Read all instructions before using this appliance.

Do not attempt to install or operate your appliance until you have read the safety precautions in this manual. Safety items throughout this manual are labeled with a WARNING or CAUTION statement based on the risk type.

#### Definitions

**⚠** This is the safety alert symbol. It is used to alert you to potential personal injury hazards. Obey all safety messages that follow this symbol to avoid possible injury or death.

#### **⚠** WARNING

**WARNING** indicates a potentially hazardous situation which, if not avoided, may result in death or serious injury.

#### **⚠** CAUTION

**CAUTION** indicates a potentially hazardous situation which, if not avoided, may result in minor or moderate injury.

#### **➔** IMPORTANT

**IMPORTANT** indicates installation, operation, maintenance or valuable information that is not hazard related.

- **Remove all tape and packaging before using the range.** Destroy the carton and plastic bags after unpacking the range. Never allow children to play with packaging material.
- **Proper installation—Be sure your appliance is properly installed and grounded by a qualified technician in accordance with the National Electrical Code ANSI/NFPA No. 70 latest edition and local electrical code requirements.** Install only per installation instructions provided in the literature package for this range.
- **User servicing—Do not repair or replace any part of the appliance unless specifically recommended in the manuals.** All other servicing should be done only by a qualified technician. This may reduce the risk of personal injury and damage to the range.
- **Never modify or alter the construction of a range by removing the leveling legs, panels, wire covers, anti-tip brackets/screws, or any other part of the range.**

Ask your dealer to recommend a qualified technician and an authorized repair service. Know how to disconnect the power to the range at the circuit breaker or fuse box in case of an emergency.

#### **⚠** WARNING

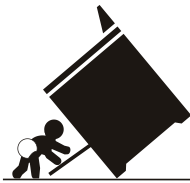

#### **Tip Over Hazard**

- **A child or adult can tip the range and be killed.**
- **Verify the anti-tip device has been installed to floor or wall.**
- **Ensure the anti-tip device is re-engaged when the range is moved to floor or wall.**
- **Do not operate the range without the anti-tip device in place and engaged.**
- **Failure to follow these instructions can result in death or serious burns to children and adults.**

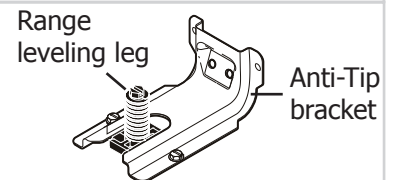

To check if the anti-tip bracket is installed properly, use both arms and grasp the rear edge of range back. Carefully attempt to tilt range forward. When properly installed, the range should not tilt forward.

Refer to the anti-tip bracket **installation instructions** supplied with your range for proper installation.

- **Remove the oven door from any unused range if it is to be stored or discarded.**

#### **⚠** WARNING

- **Stepping, leaning or sitting on the door or drawers of a range can result in serious injuries and also cause damage to the appliance. DO NOT** allow children to climb or play around the range. The weight of a child on an open oven door may cause the range to tip, resulting in serious burns or other injury
- **To avoid a possible fire hazard, never use your appliance for warming or heating the room.**

**Save these instructions for future reference.**

## IMPORTANT SAFETY INSTRUCTIONS

### WARNING

- **Storage in or on appliance — to avoid a fire hazard, flammable materials should not be stored in an oven, near surface units or in the storage drawer, warmer drawer or lower oven.** This includes paper, plastic and cloth items, such as cookbooks, plasticware and towels, as well as flammable liquids. Do not store explosives, such as aerosol cans, on or near the range.
- **DO NOT LEAVE CHILDREN ALONE — to avoid injuries or burns children should not be left alone or unattended in the area where the range is in use.** They should never be allowed to sit or stand on any part of the range including the storage drawer, lower broiler drawer, lower oven or warmer drawer.

### CAUTION

- **Do not store items of interest to children in the cabinets above a range or on the backguard of the range.** Children climbing on the range to reach items could be seriously injured.
- **Do not touch surface heating units or surface cooking elements, areas near these units or elements, or interior surfaces of oven.** Both surface heating and oven heating elements may be hot even though they are dark in color. Areas near surface cooking units may become hot enough to cause burns. During and after use, do not touch, or let clothing or other flammable materials touch these areas until they have had sufficient time to cool. Among these areas are the cook top, surfaces facing the cook top, the oven vent openings and surfaces near these openings, oven door and oven door window.
- **Wear proper apparel — loose-fitting or hanging garments should never be worn while using the appliance.** Do not let clothing or other flammable materials contact hot surfaces.
- **Do not use water or flour on grease fires — flour may be explosive. Smother the fire with a pan lid, or use baking soda, a dry chemical or foam-type extinguisher.**
- **When heating fat or grease, watch it closely.** Fat or grease may catch fire if allowed to become too hot.

### CAUTION

- **Use dry potholders — moist or damp potholders on hot surfaces may result in burns from steam.** Do not let potholders touch hot heating elements. Do not use a towel or other bulky cloth instead of a potholder.
- **Do not heat unopened food containers - buildup of pressure may cause container to burst and result in injury.**

### IMPORTANT

**Do not attempt to operate the range during a power failure.** If the power fails, always turn off the range. If the range is not turned off and the power resumes, the range will begin to operate again. Once the power resumes, reset the clock and oven function.

## IMPORTANT INSTRUCTIONS FOR USING YOUR OVEN

- **Use care when opening oven door, lower oven door or warmer drawer (if equipped)—**Stand to the side of the range when opening the door of a hot oven. Let hot air or steam escape before you remove or replace food in the oven.
- **Keep oven vent ducts unobstructed.** The oven vent is located under the left rear surface element if your model is equipped with coil elements. The oven vent is located below the backguard for models equipped with ceramic-glass cook tops. Touching the surfaces in this area when the oven is operating may cause severe burns. Also, do not place plastic or heat-sensitive items on or near the oven vent. These items could melt or ignite.
- **Placement of interior oven racks.** Always place oven racks in desired location while oven is cool. If rack must be moved while oven is hot use extreme caution. Use potholders and grasp the rack with both hands to reposition. Do not let potholders contact the hot heating elements in the oven. Remove all utensils from the rack before moving.
- **Do not use the broiler pan without its insert.** The broiler pan and its insert allow dripping fat to drain and be kept away from the high heat of the broiler. **Do not cover the broiler insert with aluminum foil. Exposed fat and grease could ignite.**
- **Protective liners—**Do not use aluminum foil to line the oven bottom. Only use aluminum foil as recommended in this manual. Improper installation of these liners may result in risk of electric shock, or fire.

## IMPORTANT SAFETY INSTRUCTIONS

### SELF-CLEANING OVENS

- **Clean in the self-cleaning cycle only the parts listed in this Use & Care Manual.** Before self-cleaning the oven, remove the broiler pan and any utensils or foods from the oven.
- **Do Not Use Oven Cleaners**—No commercial oven cleaner or oven liner protective coating of any kind should be used in or around any part of the oven.
- **Do Not Clean Door Gasket**—The door gasket is essential for a good seal. Care should be taken not to rub, damage or move the gasket.
- The health of some birds is extremely sensitive to the fumes given off during the self-cleaning cycle of any range. Move birds to another well-ventilated room.

### IMPORTANT INSTRUCTIONS FOR CLEANING YOUR RANGE

- **Clean the range regularly to keep all parts free of grease that could catch fire.** Pay particular attention to the area around each surface element. Do not allow grease to accumulate.
- **Kitchen cleaners and aerosols—Always follow the manufacturer's recommended directions for use.** Be aware that excess residue from cleaners and aerosols may ignite causing damage and injury.
- **Clean ventilating hoods frequently—Grease should not be allowed to accumulate on the hood or filter.** Follow the manufacturer's instructions for cleaning hoods.

### FOR CERAMIC-GLASS COOK TOP MODELS

- **Do not cook on broken cook top**—If cook top should break, cleaning solutions and spillovers may penetrate the broken cook top and create a risk of electric shock. Contact a qualified technician immediately.
- **Clean cook top with caution**—If a wet sponge or cloth is used to wipe spills on a hot cooking area, be careful to avoid a steam burn. Some cleaners can produce noxious fumes if applied to a hot surface.

### IMPORTANT INSTRUCTIONS FOR USING YOUR COOKTOP

- **Know which knob controls each surface heating unit.** Place a pan of food on the unit before turning it on, and turn the unit off before removing the pan.
- **Use proper pan size**—This appliance is equipped with one or more surface units of different sizes. Select utensils having flat bottoms large enough to cover the surface unit heating element. The use of undersized utensils will expose a portion of the heating element to direct contact and may result in ignition of clothing. Proper relationship of utensil to element will also improve efficiency.
- **Utensil handles should be turned inward and not extend over adjacent surface elements**—To reduce the risk of burns, ignition of flammable materials, and spillage due to unintentional contact with the utensil, the handle of the utensil should be positioned so that it is turned inward, and does not extend over adjacent surface units.
- **Never leave surface elements unattended at high heat settings**—Boilovers cause smoking and greasy spillovers that may ignite, or a pan that has boiled dry may melt.
- **Do not immerse or soak removable heating elements**—Heating elements should never be immersed in water. Heating elements clean themselves during normal operation.
- **Glazed cooking utensils**—Only certain types of glass, glass/ceramic, ceramic, earthenware, or other glazed utensils are suitable for cook top service without breaking due to the sudden change in temperature. Check the manufacturer's recommendations for cook top use.
- **When flaming foods under a ventilating hood, turn the fan on.**

### Important Safety Notice

The California Safe Drinking Water and Toxic Enforcement Act requires the Governor of California to publish a list of substances known to the state to cause cancer, birth defects or other reproductive harm, and requires businesses to warn customers of potential exposure to such substances.

## BEFORE SETTING OVEN CONTROLS

### Oven vent location

The oven vent is located **under the left side of the control panel** (See Fig. 1). When the oven is on, warm air passes through this vent. This venting is necessary for proper air circulation in the oven and good baking results. **Do not block the oven vent.**

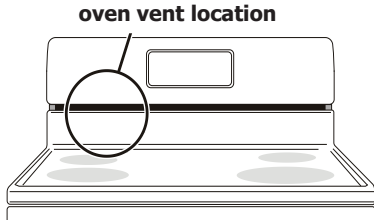

Fig. 1



### CAUTION

**Always use oven mitts when using the oven.** When using the appliance, oven racks and cooktop will become very hot which can cause burns.

### Removing, replacing & arranging racks

**To remove** - pull the rack forward until it stops. Lift up front of rack and slide out.

**To replace** - fit the rack onto the guides on the oven walls. Tilt the front of the rack upward and slide the rack back into place.

**Arranging** - always arrange the oven racks when the oven is cool (prior to operating the oven).

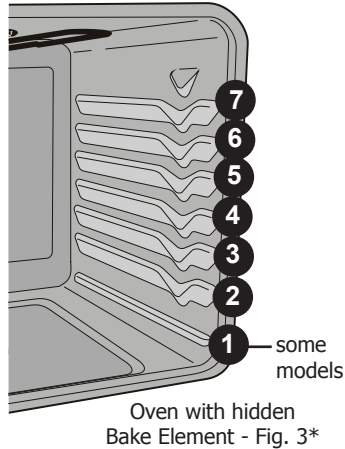
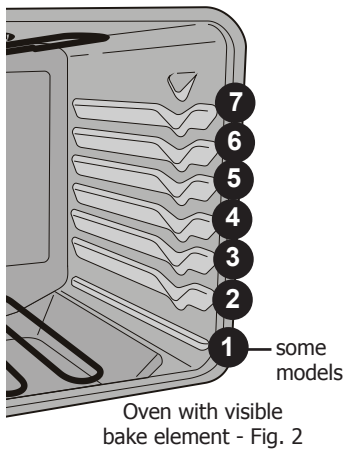

### Types of oven racks

Your range may be equipped with one or more of the oven rack styles illustrated below.

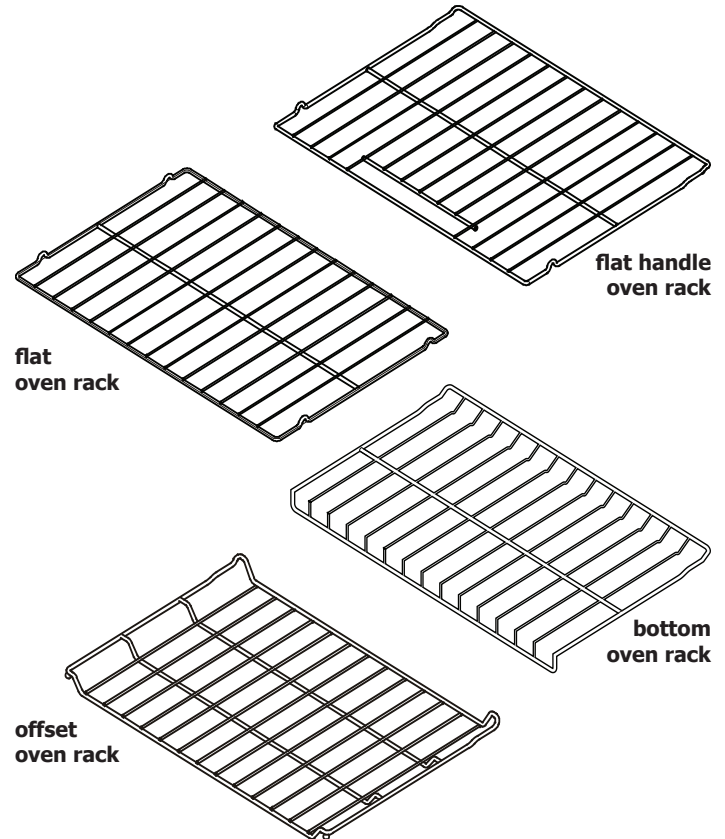

The **flat oven rack** or **flat handle oven rack** (some models) may be used for most cooking needs..

The **offset oven rack** (some models) is designed to place the base of the rack about 1/2 of a rack position lower than normal. This rack design provides several additional possible positions between the standard positions.

To maximize oven cooking space place the **bottom oven rack** (some models) in the lowest rack position for baking and when roasting large cuts of meat.

### Recommended rack positions by food type

Food type	Position models with visible bake element (Fig. 2)	Position models with hidden bake element (Fig. 3*)
Broiling meats	See broil section	See broil section
Cookies, cakes, pies, biscuits & muffins	3 or 4	3 or 4
Frozen pies, angel food cake, yeast, bread, casseroles	2 or 3	2 or 3
Small cuts of meat or poultry	2 or 3	2 or 3
Turkey, roast or ham	2	1 or 2

## BEFORE SETTING OVEN CONTROLS

### Air circulation in the oven

For best baking results allow 2-4" (5-10 cm) around the cookware for proper air circulation and be sure pans and cookware do not touch each other, the oven door, sides or back of the oven cavity. Hot air must be able to circulate around the pans and cookware in the oven for even heat to reach around the cookware (See Fig. 1).

### Baking layer cakes with 1 or 2 oven racks

For best results when baking cakes using 2 oven racks, place cookware on rack positions 2 & 5. For best results when using a single oven flat rack, place cookware on rack positions 2, 3 or 4.

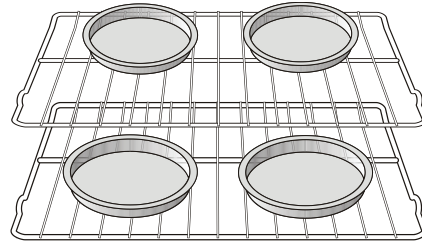

Fig. 1

## BEFORE SETTING SURFACE CONTROLS

### About the ceramic glass cooktop

The ceramic cooktop has radiant surface elements located below the surface of the glass. The design of the ceramic cooktop outlines the area of the surface element underneath. **Be sure** to match the pan size with the diameter of the element outline on the cooktop and only flat-bottomed cookware should be used.

The type and size of cookware, the number of surface elements in use and their settings are all factors that will affect the amount of heat that will spread to areas beyond the surface elements. The areas surrounding the elements may become **hot enough to cause burns**.

### About the radiant surface elements

The element temperature rises gradually and evenly. As the temperature rises, the element will glow red. To maintain the selected setting the element will cycle ON and OFF. The heating element retains enough heat to provide a uniform and consistent heat during the off cycle.

For more efficient surface cooking, turn the surface control OFF several minutes before cooking is complete. This will allow residual heat to complete the cooking process.

### on & hot surface indicator lights

Your appliance is equipped with two different types of surface element control indicator lights located on the control panel — the **on** indicator and the **hot surface** indicator lights.

The **on** indicator light (See Fig. 2) will glow when any surface element is turned ON. A quick glance at this indicator light after cooking is an easy check to be sure the surface controls are turned OFF. The **hot surface** indicator light (See Fig. 3) will glow when any surface cooking area becomes hot and will **remain on** until the glass cooktop has cooled to a **MODERATE** level.

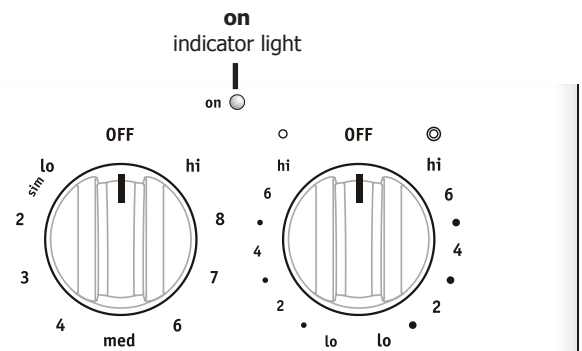

Fig. 2

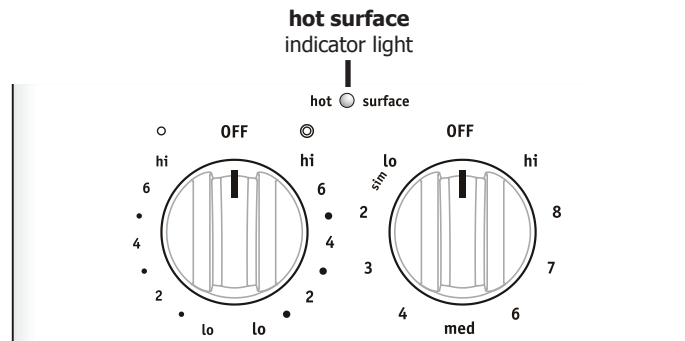

Fig. 3

### NOTES

- Radiant elements have a limiter that allows the surface element to cycle ON and OFF, even at the HI setting. This helps to prevent damage to the ceramic smoothtop. Cycling at the HI setting is normal and will occur more often if the cookware is too small for the radiant element or if the cookware bottom is not flat.
- **Be sure** to read the detailed instructions for ceramic glass cooktop maintenance and cleaning in the **Care & Cleaning** and **Before You Call** checklist sections of this Use & Care Manual.

## BEFORE SETTING SURFACE CONTROLS

### Types of cooktop elements

The ceramic glass cooktop has radiant surface elements located below the surface of the glass cooktop. The patterns on the ceramic glass will outline the size and type of element available.

The **single** radiant element will have one round outline pattern shown (**keep warm** zone is designed to keep food warm only - on some models).

The **dual** radiant element (some models) has two outline patterns. You may set just the smaller inner portion as a single element or both inner and outer portions of the element may be set to heat together. The control knobs for these element types are shown below (See Fig. 1).

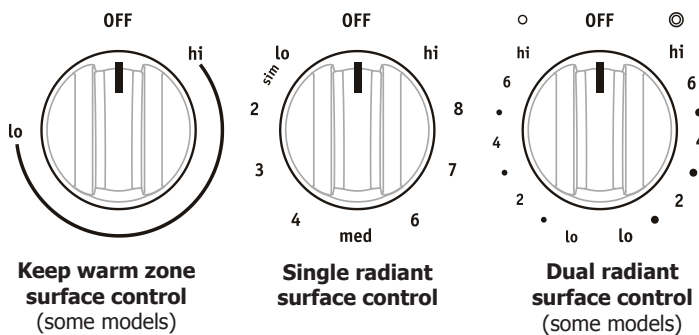

Fig. 1

### Cookware material types

The cookware material determines how evenly and quickly heat will transfer from the element to the cookware bottom. The most popular cookware materials available are:

**Aluminum** - Excellent heat conductor. Some types of food will cause it to darken (Anodized aluminum cookware resists staining & pitting). If aluminum pans slide across the ceramic cooktop, they may leave metal marks which will resemble scratches. Remove these marks immediately.

**Copper** - Excellent heat conductor but discolors easily. May leave metal marks on ceramic glass (see Aluminum).

**Stainless** - Slow heat conductor with uneven cooking results. Is durable, easy to clean and resists staining.

**Cast Iron** - A slow heat conductor however will retain heat very well. Cooks evenly once cooking temperature is reached. Not recommended for use on ceramic cooktops.

**Porcelain-enamel on metal** - Heating characteristics will vary depending on base material. Porcelain-enamel coating must be smooth to avoid scratching ceramic cooktops.

**Glass** - Slow heat conductor. Not recommended for ceramic cooktop surfaces because it may scratch the glass.

### Using proper cookware

The size and type of cookware used will influence the setting needed for best cooking results. Be sure to follow the recommendations for using proper cookware as illustrated in Figs. 2 & 3.

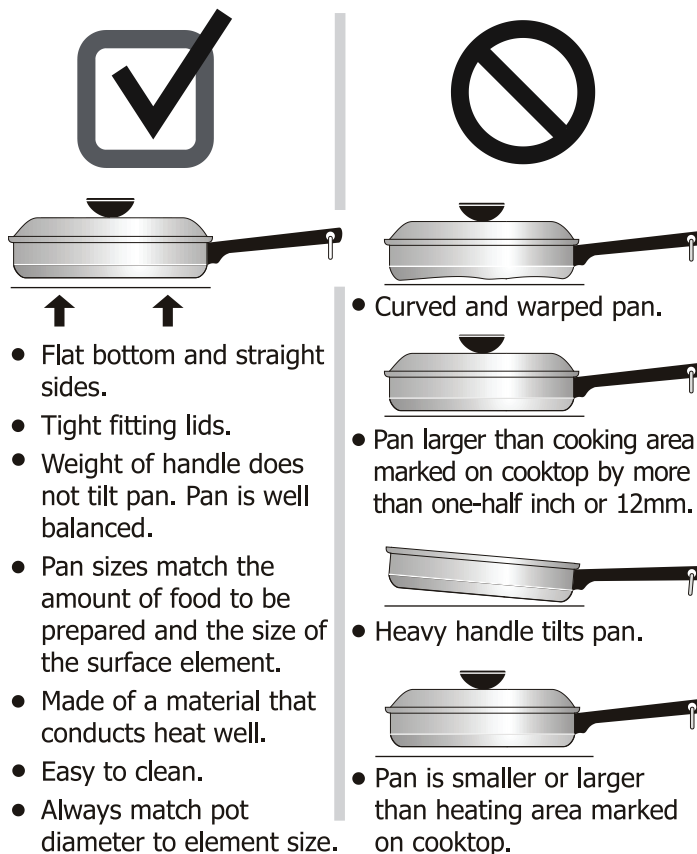

Fig. 2

Cookware should have flat bottoms that make good contact with the entire surface heating element (See Fig. 2). Check for flatness by rotating a ruler across the bottom of the cookware (See Fig. 3).

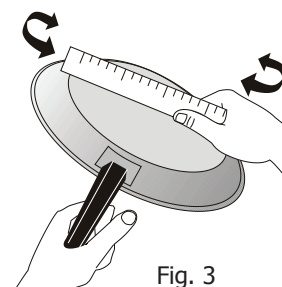

Fig. 3

### IMPORTANT

Do not place empty aluminum, glass or porcelain-enamel coated cookware on a hot ceramic cooktop! The melting point of some cookware may be reached if left heating on the cooktop when empty. The cookware can bond to the ceramic cooktop. If the cookware melts it will damage the cooktop! Be sure to follow all the manufacturer's suggestions when using any type of cookware on the ceramic cooktop.



## SETTING SURFACE CONTROLS

### Single radiant surface elements

#### To operate the single radiant element:

1. Place correctly sized cookware on single radiant surface element.
2. Push in and turn the surface control knob in either direction (Fig. 2) to the desired setting (Refer to the **Suggested radiant surface element settings table** Fig. 1). Start most cooking operations on a higher setting and then turn to a lower setting to finish cooking. The surface control knobs do not have to be set exactly on a particular spot. Use the graphics provided as a guide and adjust the control knob as needed (See Fig. 2). Each surface element provides a constant amount of heat at each setting. A glowing red surface heating area extending beyond the bottom edge of the cookware indicates the cookware is **too small** for the surface heating area.
3. When cooking is complete, turn the radiant surface element OFF before removing the cookware.

### Suggested radiant surface element settings

The suggested settings found in Fig.1 below are based when cooking with medium-weight aluminum pans with lids. Settings may vary when using other types of pans.

Recommended Setting for Surface Element	
Setting	Type of Cooking
HIGH (HI-9)	Start most foods; bring water to a boil and pan broiling.
MEDIUM HIGH (8-10)	Continue a rapid boil; frying, deep fat frying.
MEDIUM (6)	Maintain a slow boil; thicken sauces and gravies; steaming vegetables.
MEDIUM LOW (2 - 4)	Keep foods cooking; poaching and stewing.
LOW (LO)	Keep warm, melting and simmering.

Fig. 1

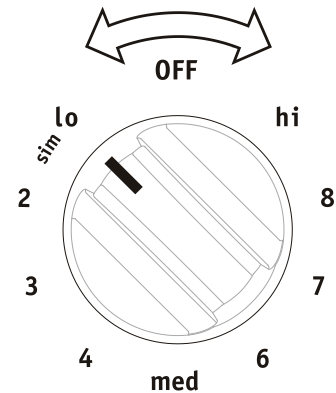

Fig. 2

### CAUTION

- Radiant surface elements may appear to have cooled after they have been turned off. **The glass surface may still be hot** and burns may occur if the glass surface is touched before it has cooled sufficiently.
- **Do not place flammable items** such as plastic salt and pepper shakers, spoon holders or plastic wrappings on top of the range when it is in use. These items could melt or ignite. Potholders, towels or wooden spoons could catch fire if placed too close to the surface elements.

### IMPORTANT

- Do not place empty aluminum, glass or porcelain-enamel coated cookware on a hot ceramic cooktop! The melting point of some cookware may be reached if left heating on the cooktop when empty. The cookware can bond to the ceramic cooktop. If the cookware melts it will damage the cooktop! Be sure to follow all the manufacturer's suggestions when using any type of cookware on the ceramic cooktop.
- **Do not allow aluminum foil, or ANY material that can melt to make contact with the ceramic glass cooktop.** If these items melt on the cooktop they can damage the ceramic cooktop.

### NOTES

- The size and type of utensil used, and the amount and type of food being cooked will influence the setting needed for best cooking results.
- The **on** indicator light will glow when one or more elements are turned ON. A quick glance at this indicator light when finished cooking is an easy check to be sure all control knobs are turned OFF. The **hot surface** indicator light will continue to glow AFTER the control knob is turned to the OFF position and will remain on until the heating surface area has cooled sufficiently.

## SETTING SURFACE CONTROLS

### Dual radiant surface elements (some models)

Symbols on the backguard will help choose which portion of the dual radiant element to set. The ○ symbol indicates a setting for the inner coil only. The ⊙ symbol indicates a setting for both inner and outer coils.

#### To operate a dual radiant element:

1. Place correctly sized cookware on dual radiant surface element.
2. Push in and turn the surface control knob clockwise (See Fig. 1) to begin heating both the inner and outer portions of the dual element. If only the inner heating portion is needed for smaller cookware, push in and turn the knob counter-clockwise to start (See Fig. 2).
3. When cooking is complete, turn the dual radiant surface element OFF before removing the cookware.

Start most cooking operations on a higher setting and then turn to a lower setting to finish cooking. The surface control knobs do not have to be set exactly on a particular mark. Use the marks as a guide and adjust the control knob as needed. A glowing red surface heating area extending beyond the bottom edge of the cookware indicates the cookware is **too small** for the surface heating area.

You may switch from either single or dual element setting at any time during cooking. See **Suggested radiant surface element settings table** on previous page.

### CAUTION

- Radiant surface elements may appear to have cooled after they have been turned off. **The glass surface may still be hot** and burns may occur if the glass surface is touched before it has cooled sufficiently.
- **Do not place flammable items** such as plastic salt and pepper shakers, spoon holders or plastic wrappings on top of the range when it is in use. These items could melt or ignite. Potholders, towels or wooden spoons could catch fire if placed too close to the surface elements.

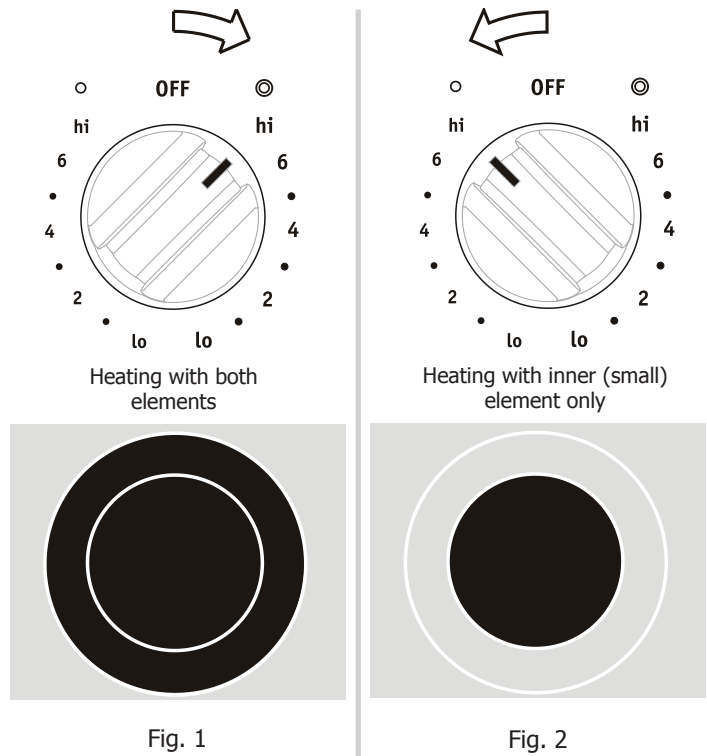

### IMPORTANT

- Do not place empty aluminum, glass or porcelain-enamel coated cookware on a hot ceramic cooktop! The melting point of some cookware may be reached if left heating on the cooktop when empty. The cookware can bond to the ceramic cooktop. If the cookware melts it will damage the cooktop! Be sure to follow all the manufacturer's suggestions when using any type of cookware on the ceramic cooktop.
- **Do not allow aluminum foil, or ANY material that can melt to make contact with the ceramic glass cooktop.** If these items melt on the cooktop they can damage the ceramic cooktop.

### NOTES

- The size and type of utensil used, and the amount and type of food being cooked will influence the setting needed for best cooking results.
- The **on** indicator light will glow when one or more elements are turned ON. A quick glance at this indicator light when finished cooking is an easy check to be sure all control knobs are turned OFF. The **hot surface** indicator light will continue to glow AFTER the control knob is turned to the OFF position and will remain on until the heating surface area has cooled sufficiently.

## SETTING SURFACE CONTROLS

### Keep warm (some models)

The purpose of the keep warm zone is to keep hot cooked foods at serving temperature. Use the keep warm feature to keep cooked foods for serving such as; vegetables, gravies, casseroles, soups, stews, breads, pastries and oven-safe dinner plates.

Always start with hot food. It is not recommended to heat cold food on the keep warm zone. All food placed on the keep warm zone should be covered with a lid to maintain quality.

For best results, when warming pastries or breads, the cover should have an opening to allow moisture to escape.

**Do not use plastic wrap to cover food. Plastic may melt onto the surface and be very difficult to clean.**

Use only dishware, utensils and cookware recommended for oven and cooktop use on the keep warm zone.

#### Setting the keep warm control:

1. Push the keep warm control knob in and turn the knob in either direction (See Fig. 1). The temperatures are approximate (See Fig. 2), and are designated by **hi** and **lo**. However, the control may be set at any position between **hi** and **lo** for different levels of warming.
2. When ready to serve, turn the keep warm zone control knob to OFF. The keep warm zone will remain warm until the **indicator light** turns OFF.

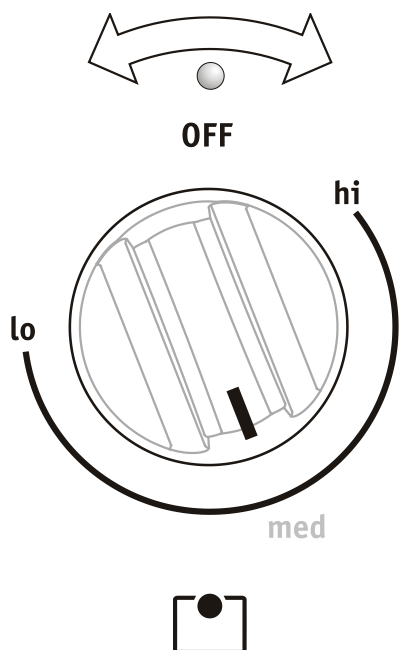

Fig. 1 (with approximate setting for medium shown)

**Temperature selection** - Refer to the **keep warm zone recommended food settings table** (See Fig. 2). If a particular food is not listed, start with the medium level, and adjust as needed. Most foods can be kept at serving temperatures by using the medium level.

#### Keep warm zone recommended food settings table

Food Item	Heating Level/Temp.
Breads/Pastries	lo, 150°F (66°C)
Casseroles	lo, 150°F (66°C)
Dinner Plates with Food	lo, 150°F (66°C)
Eggs	lo, 150°F (66°C)
Gravies	lo, 150°F (66°C)
Meats	medium, 170°F (77°C)
Sauces	medium, 170°F (77°C)
Soups (cream)	medium, 170°F (77°C)
Stews	medium, 170°F (77°C)
Vegetables	medium, 170°F (77°C)
Fried Foods	hi, 190°F (88°C)
Hot Beverages	hi, 190°F (88°C)
Soups (liquid)	hi, 190°F (88°C)

Fig. 2

### CAUTION

- Unlike the surface elements, the keep warm zone will not glow red when it is hot. To avoid burns always use potholders or oven mitts when removing food from the cooktop including the **keep warm zone** as cookware and plates **will be hot**.
- Radiant surface elements may appear to have cooled after they have been turned off. **The glass surface may still be hot** and burns may occur if the glass surface is touched before it has cooled sufficiently.
- **Do not place flammable items** such as plastic salt and pepper shakers, spoon holders or plastic wrappings on the cooktop when it is in use. These items could melt or ignite. Potholders, towels or wooden spoons could catch fire if placed too close to the surface elements.

### IMPORTANT

**Do not allow aluminum foil, or ANY material that can melt to make contact with the ceramic glass cooktop.** If these items melt on the cooktop they can damage the ceramic cooktop.

## SETTING SURFACE CONTROLS

### Home canning

Be sure to read and observe all the following points when home canning with your appliance. Check with the USDA (United States Department of Agriculture) website and be sure to read all the information they have available as well as follow their recommendations for home canning procedures.

- Use only quality flat bottom canners when home canning. Use a straight-edge to check canner bottom (see "Cookware material types" in the **Before setting surface controls** section).
- Use only a **completely flat bottom canner** with no ridges that radiate from the bottom center when home canning using a ceramic cooktop.
- **Make sure the diameter of the canner does not exceed 1 inch beyond the surface element markings or burner.** It is recommended to use smaller diameter canners on electric coil and ceramic glass cooktops.
- Start with hot tap water to bring water to boil more quickly.
- Use the highest heat setting when first bringing the water to a boil. Once boiling is achieved, reduce heat to lowest possible setting to maintain that boil.

### IMPORTANT

**NEVER** place or straddle a cooking utensil over 2 different surface cooking areas at the same time. This may cause the ceramic cooktop to fracture.

### CAUTION

- Radiant surface elements may appear to have cooled after they have been turned off. **The glass surface may still be hot** and burns may occur if the glass surface is touched before it has cooled sufficiently.
- **Do not place flammable items** such as plastic salt and pepper shakers, spoon holders or plastic wrappings on the cooktop when it is in use. These items could melt or ignite. Potholders, towels or wooden spoons could catch fire if placed too close to the surface elements.

### IMPORTANT

**Do not allow aluminum foil, or ANY material that can melt to make contact with the ceramic glass cooktop.** If these items melt on the cooktop they will damage the ceramic cooktop.

# OVEN CONTROL FUNCTIONS

## READ THE INSTRUCTIONS CAREFULLY BEFORE USING THE OVEN.

For satisfactory use of your oven, become familiar with the various keypad functions as described below.

### Oven control (for models with quick bake)

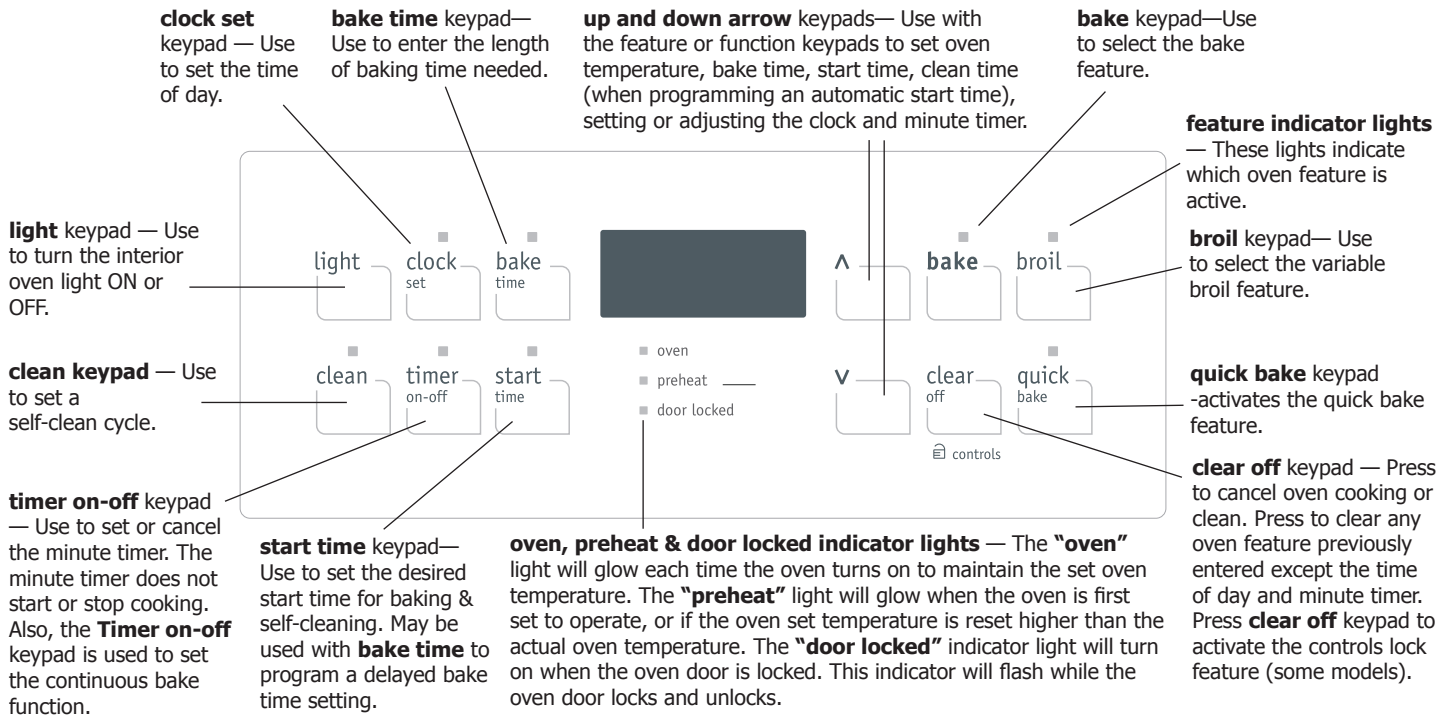

## SETTING OVEN CONTROLS

### Setting the clock

When the appliance is first plugged in or when the power supply to the appliance has been interrupted, the display will flash "12:00". It is recommended to always set the clock for the correct time of day before using the appliance.

#### To set the clock:

1. Press **clock set** once (do not hold keypad down).
2. Within 5 seconds, press and hold the **▲** or **▼** until the correct time of day appears in the display.

#### NOTE

The time of day cannot be changed when the oven or clean is active.

### Changing between continuous bake setting or 12-Hour Energy Saving feature

The oven control has a built-in 12-Hour Energy Saving feature that will shut off the oven if the control is left on for more than 11 hours and 59 minutes. The oven can be programmed to override this feature for continuous baking.

#### Changing to continuous bake setting:

1. Press and hold **timer on-off** keypad for 5 seconds until a tone sounds, " — — hr" will appear in display for continuous cooking. The current time of day will return to the display.
2. To cancel the continuous bake setting, press **timer on-off** keypad and hold for 5 seconds until a tone sounds. "12hr" will appear in display indicating that the control has returned to the 12-Hour Energy Saving feature.

#### NOTE

Changing between continuous bake or the 12-Hour Energy saving modes will not change how the cooktop controls operate.

### Changing oven temperature display (°F or °C)

The electronic oven control is set to display °F (Fahrenheit) temperatures by default when shipped from the factory.

#### To change the temperature to display °C (Celsius) or from °C to °F (control should not be set for bake or clean when setting this feature):

1. Press **broil** keypad. " — — " appears in the display.
2. Press and hold the **▲** until "HI" appears in the display.
3. Press and hold **broil** keypad until °F or °C appears in the display.
4. Press the **▲** or **▼** to change °F to °C or °C to °F.
5. Press any control keypad to return to normal operating mode.

#### NOTE

The temperature display (°F or °C) feature cannot be changed when the oven or clean is active.

### Setting a silent control panel

A beep will sound each time a control keypad is pressed. If desired, the control may be programmed for silent operation.

Press and hold the **start time** keypad. After 7 seconds, the control will beep once then release keypad.

This will block the controls from sounding when a keypad is pressed in the future.

To turn the silent control panel feature off, press and hold **start time** keypad again for 7 seconds until the control beeps once.

## SETTING OVEN CONTROLS

### Setting controls lock

The oven control may be programmed to lock the oven control keypads and the oven door.



#### To set the controls lock feature:

1. Press **clear off** keypad and hold for 3 seconds. "Loc" will appear in display, the "door locked" indicator light will flash and the motor driven door lock will begin to close automatically. **Allow about 15 seconds** for the oven door to lock. Once the oven door is locked, the current time of day will appear in the display.
2. To cancel the controls lock feature, press **clear off** keypad and hold for 3 seconds. The control will unlock the oven door and resume normal keypad operation.

### NOTES

- To avoid possible damage to the oven door latch locking mechanism, do not attempt to open or close the oven door whenever the "door locked" indicator light is flashing.
- If a control keypad is pressed when controls lock is active, "Loc" will appear in the display as a reminder that the keypad action requested is not available when the controls lock feature is active.

### Setting the minute timer

#### To set the minute timer:

1. Press **timer on-off** keypad.
2. Press the **▲** to increase the minute timer in one minute increments. Press and hold the **▲** to increase the time in 10 minute increments. The minute timer may be set for any amount of time from 1 minute to 11 hours and 59 minutes.

If the **▼** keypad is pressed first, the timer will advance to 11 hours and 59 minutes.

3. When the set time has run out, the minute timer will beep 3 times and will continue to beep 3 times every 60 seconds until **timer on-off** keypad is pressed.

#### To change the minute timer while it is in use:

While the timer is active and shows in the display, press and hold the **▲** or **▼** to increase or decrease the time remaining.

#### To cancel the minute timer before the set time has run out:

Press **timer on-off** keypad once.

### NOTES

- The indicator light located above the **timer on-off** keypad will glow when the minute timer is active.
- The minute timer does not start or stop the cooking process. It serves as an extra timer in the kitchen that will beep when the set time has run out. The minute timer may be used alone or when any other oven function is active.
- The minute timer will display hours and minutes until 1 hour remains. When less than 1 hour remains, the display will count down in minutes and seconds. Once the timer has less than 1 minute remaining only seconds will display.
- If the minute timer is active and the oven is active, the timer will show in the display by default. To view information of any other active oven function, press the keypad once for the active function to view status.

## SETTING OVEN CONTROLS

### Setting bake

The oven may be programmed to bake at any temperature between 170°F to 550°F (77°C to 287°C). The factory preset automatic bake temperature is 350°F (177°C).

#### To set bake:

1. Press **bake**. “— — —” appears in the display.
2. Within 5 seconds, press the **▲** or **▼**. The display will show “350°F (177°C).” By pressing and holding the **▲** or **▼**, the temperature may be adjusted in 5°F increments (1°C if the control is set to display Celsius).
3. As soon as the **▲** or **▼** keypad is released, the oven will begin heating to the selected temperature. When the displayed temperature reaches the desired baking temperature, the preheat indicator light will turn OFF. The control will beep 3 times as a reminder.
4. To cancel bake, press **clear off** keypad.

#### To change the oven temperature after bake has started:

1. Press **bake**. Visually check the bake temperature at this time.
2. Press the **▲** or **▼** keypad to increase or decrease the set temperature to the desired new oven temperature.

### IMPORTANT

Dark or dull pans absorb more heat than shiny bakeware resulting in dark or overbrowning of foods. It may be necessary to reduce the oven temperature or cook time to prevent overbrowning of some foods. Dark pans are recommended for pies. Shiny pans are recommended for cakes, cookies and muffins.

### NOTES

- A short time after starting bake the **preheat** indicator light will turn OFF, indicating your oven has reached the set baking temperature. The control will sound 3 beeps as a reminder the oven is ready.
- The **oven** indicator light on the oven control display will turn ON and OFF while using the Bake feature. This is normal and indicates that the oven elements are cycling to maintain the selected baking temperature.

### Setting bake time and start time features

The **bake time** and **start time** keypads provide settings that will turn the oven ON and OFF at the times you select in advance. The oven may be programmed to start immediately and shut-off automatically (timed bake) or to begin baking at a later time with a delayed start time (delayed timed bake).

### CAUTION

Use caution with the bake time and (delayed) start time features. Foods that can easily spoil such as milk, eggs, fish, meat or poultry, should be chilled in the refrigerator first. Even when chilled, they should not stand in the oven for more than 1 hour before cooking begins, and should be removed promptly when cooking is completed.

#### To program the oven to begin baking immediately and to shut off automatically (timed bake):

1. Be sure that the clock shows the correct time of day.
2. Place the food in the oven.
3. Press **bake**. “— — — °” appears in the display.
4. Within 5 seconds, press the **▲** or **▼**. The display will show “350°F (177°C).” By holding the **▲** or **▼**, the temperature may be further adjusted in 5°F increments (1°C if the control is set to display Celsius).
5. Press **bake time**. “:00” will appear in the display.
6. Press the **▲** or **▼** and release when the desired bake time appears in the display.
7. The oven will turn ON and begin heating and turn off automatically after the set bake time is finished.

### NOTES

- A bake time or start time setting cannot be added when broiling.
- The bake time feature may be added when using **quick bake** (some models).
- The maximum bake time setting is 11 hours & 59 minutes.
- While baking with a bake time setting, press the bake time keypad to display any cook time remaining.



### Setting bake time and start time features (cont'd)

#### **WARNING**

**FOOD POISONING HAZARD.** Do not let food sit for more than one hour before or after cooking. Doing so can result in food poisoning or sickness.

#### **CAUTION**

Use caution with the bake time and (delayed) start time features. Foods that can easily spoil such as milk, eggs, fish, meat or poultry, should be chilled in the refrigerator first. Even when chilled, they should not stand in the oven for more than 1 hour before cooking begins, and should be removed promptly when cooking is completed.

#### **To program oven for a delayed start time and to shut-off automatically (delayed timed bake):**

1. Be sure the clock displays the correct time of day.
2. Place the food in the oven.
3. Press **bake**. " — — — ° " appears in the display.
4. Within 5 seconds, press the **▲** or **▼**. The display will show 350°F (177°C). By holding the **▲** or **▼**, the temperature may be further adjusted in 5°F increments (1°C if the control is set to display Celsius).
5. Press **bake time**. ":00" will appear in the display.
6. Press the **▲** or **▼** and release when the desired bake time appears in the display.
7. Press **start time**. The time of day will appear in the display.
8. Press the **▲** or **▼** and release when the desired start time appears in the display.
9. Once the correct times are set, the oven will turn ON at the delayed start time and turn off automatically after the set bake time is finished.

#### **When the set bake time runs out:**

1. "End" will appear in the display window and the oven will shut-off automatically.
2. The control will beep 3 times every 60 seconds as a reminder until the **clear off** keypad is pressed.

#### **To change the oven temperature or bake time after baking has started:**

1. Press the function keypad you want to change.
2. Press the **▲** or **▼** to adjust the setting.

#### **NOTES**

- A **bake time** or **start time** setting cannot be added when broiling.
- The maximum bake time or start time setting is 11 hours & 59 minutes.
- During a start time operation the oven preheat function will be delayed until the set time to start cooking is reached.

## SETTING OVEN CONTROLS

### Quick bake (some models)

#### Benefits of the quick bake feature

- Foods cook more evenly
- Multiple rack baking
- No special pans or bakeware needed

**Quick bake** uses a fan to circulate the oven's heat uniformly and continuously around the oven. This improved heat distribution allows for fast, even cooking and browning results. It also provides better baking performance when using two racks at the same time.

Heated air flows around the food from all sides, sealing in juices and flavors. Meats cooked with **quick bake** are juicier. Poultry is crisp on the outside while staying tender and moist on the inside. Breads and pastry brown more evenly. Most foods baked in a standard oven can be cooked faster and more evenly with **quick bake**.

#### Suggestions for quick bake

##### When baking

- For optimum cooking results it is recommended to preheat the oven when baking foods such as cookies, biscuits and breads.
- Reduce oven temperature 25°F from recipe's recommended oven temperature. Follow the remainder of the recipe's instructions using the minimum recommended cook time.
- When using 2 oven racks at the same time, place in positions 2 & 5 for best results (See Fig. 1).

##### When roasting

- Preheating is not necessary when roasting foods using **quick bake**.
- Reduce the cook time by 25% from the recommended cook time of your recipe. Check the food at this time. If necessary, increase cook time until the desired doneness is obtained.

### NOTES

- When using quick bake cook time reductions may vary depending on the amount and type of food being cooked.
- Layer cakes will have better results using the **bake** feature.
- If the oven door is opened when quick bake is active, the fan will stop rotating until the oven door is closed.

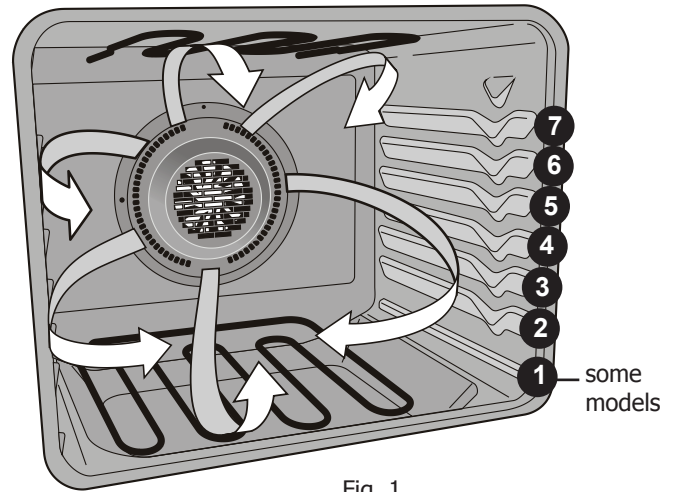

Fig. 1

### Setting quick bake

The oven may be programmed for quick bake at any temperature from 170°F to 550°F (77°C to 287°C). The factory preset automatic bake temperature is 350°F (177°C).

#### To set quick bake:

1. Press **quick bake**. "— — —" appears in the display.
2. Within 5 seconds, press the **▲** or **▼**. The display will show "350°F (177°C)." By pressing and holding the **▲** or **▼**, the temperature can then be adjusted in 5°F increments (1°C if the control is set to display Celsius).
3. As soon as the **▲** or **▼** keypad is released, the oven will begin heating to the selected temperature. When the displayed temperature reaches the desired baking temperature, the preheat indicator light will turn OFF and the control will beep 3 times.
4. To cancel quick bake, press **clear off** keypad.

#### To change the oven temperature after quick bake has started

1. Press **quick bake** key pad.
2. If necessary, press the **▲** or **▼** pad to increase or decrease the oven set temperature.

## SETTING OVEN CONTROLS

### Setting broil

Use the broil feature to cook meats that require direct exposure to radiant heat for optimum browning results. When broiling always remember to arrange the oven racks while oven is still cool. Position the rack as suggested in the **broil settings table** (See Figs. 1 & 4).

#### To set Broil

1. Arrange the oven rack while oven is still cool.
2. Press **broil**. " — — " will appear in display.
3. Press and hold the **▲** or **▼** until the desired broil setting level appears in the display. Press the **▲** for **HI** broil or the **▼** for **LO** broil. Most foods may be broiled at the **HI** broil setting. Select the **LO** broil setting to avoid excess browning or drying of foods that should be cooked to the well-done stage.
4. **For optimum results, preheat oven for 5 minutes before adding food.**
5. Place the insert on broil pan (if equipped), then place food on broil pan insert (if equipped - See Fig. 2).
6. Place broiler pan and insert on oven rack.
7. **Keep the oven door open** at the broil stop position when broiling (See Fig. 3).
8. Broil food on one side until desired brownness is obtained. Turn food and broil on other side.
9. When finished broiling remove food items and press **clear off**.

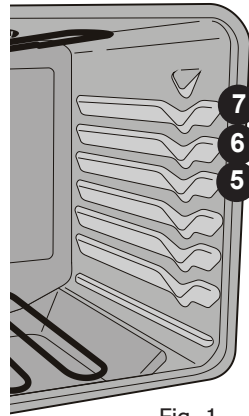

Fig. 1

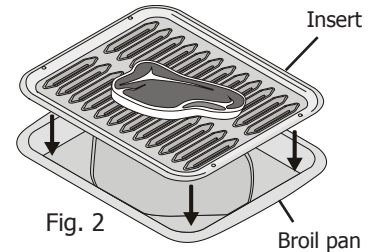

Fig. 2

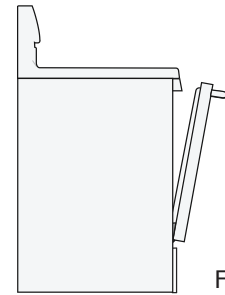

Fig. 3

### ! WARNING

Should an oven fire occur, close the oven door and turn the oven OFF. If the fire continues, use a fire extinguisher. **DO NOT** put water or flour on the fire. Flour may be explosive.

### ! CAUTION

The broiler pan and the insert (some models) allows grease to drain and be kept away from the high heat of the broiler. **DO NOT** use the pan without the insert. **DO NOT** cover the insert with foil; the exposed grease could ignite. **DO NOT** use the broil pan without the insert or cover the insert with **aluminum foil**. The exposed fat could ignite. To insure the best results when broiling **ONLY** use Electrolux Home Products, Inc. approved broil pan & insert.

### 📌 NOTE

Always pull the oven rack out to the stop position before turning or removing the food.

**Suggested broil settings table**

Food	Rack position	Setting	Cook time in minutes		Doneness
			1st side	2nd side	
Steak 1" thick	5th or 7th*	Hi	6	4	Medium
Steak 1" thick	6th or 7th*	Hi	7	5	Medium-well
Steak 1" thick	6th or 7th*	Hi	8	7	Well
Pork chops 3/4" thick	6th	Hi	8	6	Well
Chicken-bone in	5th	Lo	20	10	Well
Chicken-boneless	6th	Lo	8	6	Well
Fish	6th	Hi	13	n/a	Well
Shrimp	5th	Hi	5	n/a	Well
Hamburger 1" thick	7th*	Hi	9	7	Medium
Hamburger 1" thick	6th	Hi	10	8	Well

Fig. 4

\*Use the off-set rack if you choose to use oven rack position 7.

## SETTING OVEN CONTROLS

### Adjusting the oven temperature

Your appliance has been factory calibrated and tested to ensure an accurate baking temperature. For the first few uses, follow your recipe times and temperature recommendations carefully. If you think the oven is cooking too hot or too cool for your recipe times, you can adjust the control so the oven cooks hotter or cooler than the temperature displayed.

#### To adjust oven temperature

1. Press **bake** key pad.
2. Set the temperature to 550°F (287°C) by pressing and holding the **▲** keypad.
3. Within 2 seconds, press and hold **bake** keypad until the 2 digit display appears. Release **bake** keypad. The display now indicates the amount of degrees offset between the original factory temperature setting and the current temperature setting. If the oven control has the original factory calibration, the display will read "0."
4. The temperature can now be adjusted up or down 35°F (19°C), in 5°F increments by pressing and holding the **▲** or **▼** keypad. Adjust until the desired amount of offset appears in the display. When lowering the oven temperature, a minus sign (-) will appear before the number to indicate that the oven will be cooler by the displayed amount of degrees.
5. When you have made the desired adjustment, press **clear off** to go back to the time of day display.

### NOTES

- Any oven temperature offset made will not affect the broil or clean feature temperatures.
- If the oven display has been set to display Celsius, adjustments made will be in 1°C increments with each press of the **▲** or **▼** keypad.
- **DO NOT USE** oven thermometers such as those found in grocery stores to check the temperature settings inside the oven. These oven thermometers may vary as much as 20 to 40 degrees from actual temperatures.

### Operating the oven light

The interior oven light will automatically turn ON when the oven door is opened.

Press the **light** keypad to turn the interior oven light ON and OFF whenever the oven door is closed.

The interior oven light is located at the upper left rear wall of the oven interior and is covered with a glass shield held by a wire holder. The glass shield must be in place whenever the oven is in use.

To change the interior oven light, see "Changing the oven light" in the **Care & Cleaning** section.

## Clean

A self-cleaning oven cleans itself with high temperatures (well above normal cooking temperatures) which eliminate soils completely or reduces them to a fine powdered ash you can wipe away with a damp cloth.

### → IMPORTANT

#### Read before starting self-clean

- **Completely remove ALL OVEN RACKS and ANY ACCESSORIES FROM OVEN CAVITY** to avoid possible damage to oven racks. If the oven racks are not removed they may discolor.
- Remove **ALL** items from the oven and cooktop including **cookware, utensils** and **ANY ALUMINUM FOIL**. Aluminum foil will not withstand high temperatures from a self-clean cycle.
- **DO NOT** line the oven walls, racks, bottom or any other part of the range with aluminum foil. Doing so will destroy heat distribution, produce poor baking results and may cause permanent damage to the oven interior. During self-clean temperatures in the oven can become hot enough to melt aluminum foil.
- **DO NOT** use or spray oven cleaners or oven protective coatings in or around any part of the oven interior.
- Clean any soil from the outer oven frame, the door liner outside the oven door gasket and the small area at the front center of the oven bottom. These areas (See Fig. 1) heat sufficiently to burn soil on. Clean using soap and water before starting self-clean.
- Remove any excessive **spillovers**. Any spills on the oven bottom should be wiped-up and removed **before starting self-clean**. To clean, use hot, soapy water and a cloth. Large spillovers can cause heavy smoke or fire when subjected to high temperatures. **DO NOT** allow food spills with a high sugar or acid content (such as milk, tomatoes, sauerkraut, fruit juices or pie filling) to remain on the surface as they may leave a dull spot even after cleaning.
- **DO NOT clean the oven door gasket** (See Fig. 1). The woven material of the oven door gasket is essential for a good seal. Care should be taken not to rub, damage or remove the gasket. **DO NOT** use any cleaning materials on the oven door gasket. Doing so could cause damage to the door gasket.

### ⚠ CAUTION

- **DO NOT** leave small children unattended near the appliance. During the self-cleaning cycle, the outside of the range can become very hot to the touch.
- The health of some birds is extremely sensitive to the fumes given off during the self-cleaning cycle of any range. Move birds to another well-ventilated room.
- **DO NOT** force the oven door open when self-clean is active. This can damage the automatic door locking system. Use caution when opening the door after the self-Cleaning cycle is completed. The oven may still be **VERY HOT**.
- The oven bake and broil elements may appear to have cooled after they have been turned OFF. **The elements may still be hot** and burns may occur if these elements are touched before they have cooled sufficiently.

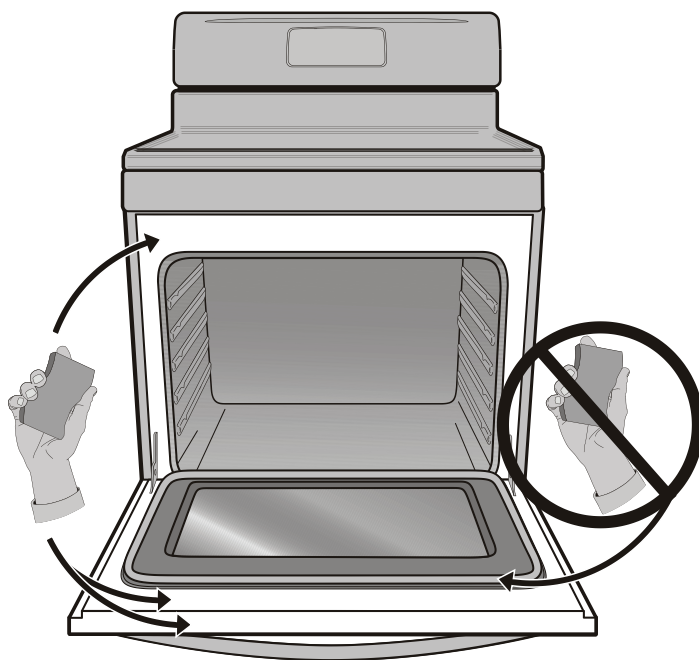

Fig. 1

(For models that have a visible bottom bake element ONLY): To help remove excessive spills from the oven bottom, the lower element may be tilted up from the **front** of the element.

Wait until the oven is **completely cool** and remove the bottom oven rack before attempting to raise the element. Do not to raise the lower element more than 4 or 5 inches from the resting position.

## CLEAN

### Setting a self-clean cycle or a delayed start self-clean cycle

#### Setting a self-clean cycle

1. Remove all items from the oven, cooktop, and all oven racks from the oven and be sure the oven door is completely closed. Be sure the oven control displays the correct time of day and adjust if needed.

#### NOTE

To start a self-clean cycle immediately without delay, skip steps 2 & 3 in the instructions provided below.

2. Press the **start time** keypad. The ":" in the time of day display will flash.
3. Press and hold the **▲** keypad to scroll to the time to start a delayed self-clean cycle. Release the keypad when the desired start time is displayed.
4. Press the **clean** keypad. "---" appears in the display.
5. To start press the **▲** or **▼** keypad once. "3:00" will appear in the display indicating that a 3 hour self-clean time is set. To change to a shorter 2 hour self-clean time press the **▼** keypad once ("2:00" will appear in the display indicating a 2 hour clean time is desired).

#### IMPORTANT

Once the oven control is set for clean, the motor driven lock will begin to automatically lock the oven door. The "door locked" indicator light will flash while the oven door is locking. **DO NOT** open the oven door while this indicator light is flashing (allow about 15 seconds for the oven door to completely lock).

6. "CLn" will appear in the oven display during the self-clean cycle and the "door locked" indicator light will remain ON until the self-cleaning cycle is complete or cancelled and the oven temperature has cooled.

#### When the self-clean cycle has completed:

1. The time of day will appear in the oven display and the "clean" and "door locked" indicator lights will continue to glow.
2. Once the oven has cooled down for about 1 hour and the "door locked" light has turned off, the oven door may be opened.

#### Stopping or interrupting a self-clean cycle If it becomes necessary to stop or interrupt a self-cleaning cycle once it has been activated:

1. Press the **clear off** keypad.
2. Once the oven has cooled down (about 1 hour) and the "door locked" indicator light has turned off, the oven door may be opened.
3. If needed, the self-clean may be restarted.

#### CAUTION

- To avoid possible burns use care when opening the oven door after the self-cleaning cycle is finished. **Stand to the side of the oven** when opening the oven door to allow any hot air or steam to escape.
- **DO NOT** force the oven door open. This can damage the automatic door locking system. Use caution and avoid possible burns when opening the oven door after the self-cleaning cycle has completed. The oven may still be **VERY HOT**.

#### NOTES

- Whenever the **clean** feature is active you may check the amount of time remaining in the self-clean cycle by pressing the **clean** keypad once. Remember the oven door will not unlock until the range has cooled sufficiently. You will need to **add about 1 hour to the time** displayed before you can use the oven for cooking again.
- After the oven has completely cooled and the oven door has unlocked, wipe away any residue or powdered ash from the oven interior using a damp cloth or paper towel.

### Cleaning recommendation table

Surface type	Recommendation
<ul style="list-style-type: none"> <li>• <b>Control knobs</b> (some models)</li> <li>• <b>Painted body parts</b></li> <li>• <b>Painted decorative trim</b></li> <li>• <b>Aluminum, plastic or vinyl trim</b></li> </ul>	<p>For general cleaning, use hot, soapy water and a cloth. For more difficult soils and built-up grease, apply a liquid detergent directly onto the soil. Leave on soil for 30-60 minutes. Rinse with a damp cloth and dry. Do not use abrasive cleaners on any of these materials; they can scratch. To remove control knobs (some models), turn to OFF position; grasp firmly and pull knob straight off the shaft. To replace knobs after cleaning, line up the flat sides of both knob and shaft; then push knob into place.</p>
<ul style="list-style-type: none"> <li>• <b>Control panel</b></li> <li>• <b>Control keypad membrane</b></li> <li>• <b>Decorative trim</b> (some models)</li> </ul>	<p>Before cleaning the control panel, turn all controls OFF, activate controls lock (if equipped) and remove any knobs from panel (some models). Do not use abrasive cleaners on any of these materials; they can scratch. Clean using hot, soapy water and a dishcloth. Be sure to squeeze excess water from dishcloth before wiping control panel; especially when wiping around the controls area. Excess water in or around the controls may cause damage to the appliance. When rinsing, use clean water and a dishcloth and be sure to squeeze excess water from dishcloth before wiping the control panel.</p>
<ul style="list-style-type: none"> <li>• <b>Porcelain enamel parts</b></li> <li>• <b>Porcelain enamel broiler pan and broiler pan insert</b> (if equipped)</li> </ul>	<p>Gentle scrubbing with a soapy <b>no-scratch</b> cleaning pad will remove most spots. Rinse with a 1:1 solution of clear water and ammonia. If necessary, cover difficult spots with an ammonia-soaked paper towel for 30 to 40 minutes. Rinse with clean water and a damp cloth, and then scrub with a soap-filled <b>no-scratch</b> cleaning pad. Rinse and wipe dry with a clean cloth. Do not allow food spills with high sugar or acid content (milk, tomatoes, sauerkraut, fruit juices or pie filling) to remain on the surface; they may cause a dull spot even after cleaning.</p>
<ul style="list-style-type: none"> <li>• <b>Oven interior</b></li> </ul>	<p>Remove excessive spillovers from oven bottom <b>before</b> starting self-clean. Clean any soils from oven frame and door liner outside the oven door gasket. For very important preparation information be sure to read all the instructions in the self-cleaning section.</p>
<ul style="list-style-type: none"> <li>• <b>Oven racks</b></li> </ul>	<p><b>Do not clean oven racks in oven using the self-clean cycle.</b> Remove oven racks and clean using a mild, abrasive cleaner following manufacturer's instructions. Thoroughly rinse and dry.</p>
<ul style="list-style-type: none"> <li>• <b>Oven door</b></li> </ul>	<p>Use soap &amp; water to thoroughly clean the top, sides and front of the oven door. Rinse well. You may use a glass cleaner on the outside glass of the oven door. <b>Do not</b> immerse the door in water. <b>Do not spray or allow water or the glass cleaner to enter the door vents.</b> Do not use oven cleaners, cleaning powders or any harsh abrasive cleaning materials on the outside of the oven door. <b>Do not</b> clean the oven door gasket. On self-cleaning models the oven door gasket is made of a woven material which is essential for a good seal. Care should be taken not to rub, damage or remove this gasket.</p>
<ul style="list-style-type: none"> <li>• <b>Stainless steel</b> (some models)</li> </ul>	<p>Only use cleaners and polishes that are specifically made for cleaning stainless steel. Always rub in direction of metal grain to avoid damaging. <b>Do not use cleaners with high concentrations of chlorides or chlorine.</b> Do not use harsh scrubbing cleaners. Polish with a lint-free cloth. Always be sure to wipe excess cleaner/polish off from the metal surface as bluish stains may occur during future oven heating that cannot be removed. Clean heavier soils with hot, soapy water and a dishcloth. Rinse and dry using clean water and a cloth.</p>
<ul style="list-style-type: none"> <li>• <b>Ceramic cooktop</b></li> </ul>	<p>See Cooktop Cleaning and Maintenance in the <b>Care &amp; Cleaning</b> section.</p>

## CARE & CLEANING

### Cooktop maintenance

#### ➔ IMPORTANT

**Consistent and proper cleaning is essential to maintaining your ceramic glass cooktop.**

Prior to using your cooktop for the first time, apply some of the glass-ceramic cooktop cleaner supplied with your new appliance. Buff with a **non-abrasive** cloth or no-scratch cleaning pad. This will make cleaning easier when soiled from cooking. The special cooktop cleaning cream leaves a protective finish on the glass to help prevent scratches and abrasions.

Sliding aluminum or copper clad bottom pans on the cooktop can cause metal markings on the cooktop surface. These marks should be removed **immediately** after the cooktop has cooled using the cooktop cleaning cream. Metal marks can become permanent if not removed prior to future use. Cookware (cast iron, metal, ceramic or glass) with rough or dirty bottoms can **mark or scratch** the cooktop surface.

#### To maintain the cooktop appearance:

- Do not slide anything metal or glass across the cooktop.
- Do not use cookware with dirt or dirt build up on bottom; replace with clean cookware before using.
- Do not use your ceramic cooktop as a cutting board or work surface in the kitchen.
- Do not cook foods directly on the cooktop surface without a pan.
- Do not drop heavy or hard objects on the ceramic glass cooktop, they may cause it to crack.

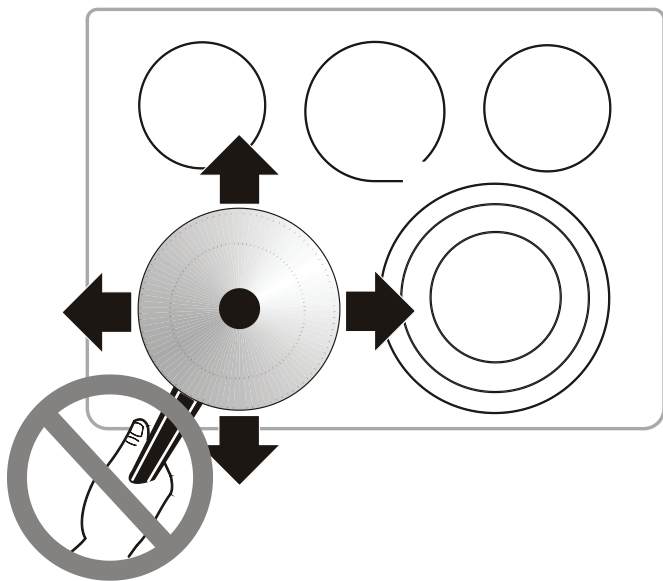

### Cooktop cleaning

#### ⚠ CAUTION

Before cleaning the cooktop, be sure the controls are turned to OFF and the cooktop is COOL.

#### ⚠ WARNING

**DO NOT use a cooktop cleaner on a hot cooktop. The fumes can be hazardous to your health and can chemically damage the ceramic glass surface.**

**For light to moderate soil** - Apply a few drops of glass-ceramic cooktop cleaner directly to the cooktop. Use a paper towel or use a non-abrasive plastic type no-scratch cleaning pad to clean the entire cooktop surface. Make sure the cooktop is cleaned thoroughly, leaving no residue.

**For heavy, burned on soil** - Apply a few drops of glass-ceramic cooktop cleaner directly to the soiled area. Rub the soiled area using a non-abrasive plastic type no-scratch cleaning pad, applying pressure as needed. Do not use the pad you use to clean the cooktop for any other purpose.

If soils remain, carefully scrape soils with a metal razor blade scraper, holding scraper at a 30 degree angle to the surface. Remove loosened soils with cooktop cleaning cream and buff surface clean.

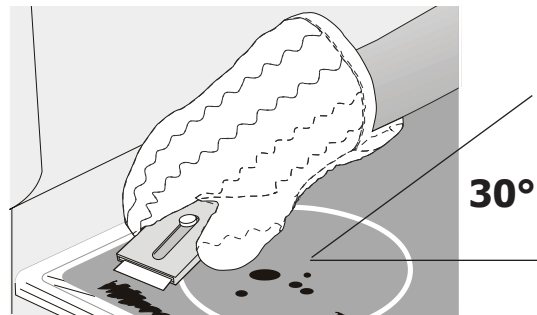

#### Removing plastic or foods with a high sugar content:

These types of soils need be removed immediately if spilled or melted onto the ceramic cooktop surface. Permanent damage (such as pitting of the cooktop surface) may occur if not removed **immediately**. After turning the surface elements OFF, use a razor blade scraper or a metal spatula with a mitt and scrape the soil from the hot surface (as illustrated). Allow the cooktop to cool, and use the same method for heavy or burned on soils.

#### ➔ IMPORTANT

Damage to the ceramic glass cooktop may occur if you use an abrasive cleaning pad. Only use cleaning products that have been specifically designed for cooktops.



### Cooktop cleaning (cont'd)

**DO NOT use the following on the cooktop:**



- Do not use abrasive cleaners and scouring pads, such as metal and some nylon pads. They may scratch the cooktop, making it more difficult to clean.
- Do not use harsh cleaners, such as chlorine bleach, ammonia or oven cleaners, as they may etch or discolor the cooktop.
- Do not use dirty sponges, cloths or paper towels, as they can leave soil or lint on the cooktop which can burn and cause discoloration.

### Aluminum foil and oven liners

#### **WARNING**

**Protective liners**—Do not use aluminum foil to line the oven bottom. Only use aluminum foil as recommended in this manual. Improper installation of these liners may result in risk of electric shock, or fire.

Using liners in the oven will restrict the heat and air flow needed to obtain the best possible cooking results for any oven, including the warmer drawer (some models).

Do not use oven bottom liners or use aluminum foil to cover the oven bottom or any oven racks.

During self-clean the oven temperature can become hot enough to melt aluminum cooking utensils or aluminum foil which could result in damage to the oven interior porcelain finish.



### Aluminum foil and oven liners (cont'd)

**Aluminum foil and the cooktop** - Use of aluminum foil on a hot cooktop can damage the ceramic glass. Do not use thin aluminum cooking utensils or allow aluminum foil to touch the ceramic cooktop under ANY circumstances.

**Aluminum utensils and the cooktop** - Care must be taken when aluminum pots or pans are used on the cooktop. If aluminum pans are allowed to boil dry when using the cooktop, the utensil can become hot enough to be damaged or destroyed, and may fuse to, break or mark the ceramic glass surface, permanently damaging the cooktop surface.

### Replacing interior oven light

#### **CAUTION**

Be sure the range is unplugged and all parts are COOL before replacing oven light. Wear a leather-faced glove for protection against possible broken glass.

The interior oven light is located at the rear of the oven interior back wall and is covered with a glass shield held by a wire holder.

The glass shield must always be in place to protect and shield the oven interior light whenever using the oven.

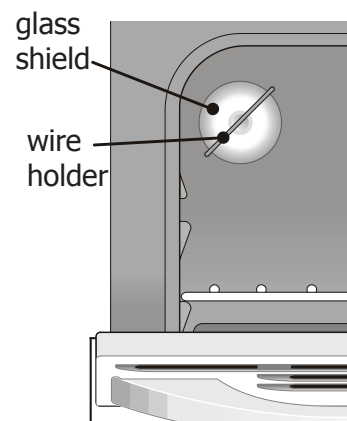

#### **To replace the oven light bulb:**

1. Turn electrical power off at the main source or unplug the range.
2. While holding the glass shield in place, press wire holder to one side to release the glass shield.
3. Remove glass shield. Replace bulb with a new 40 watt appliance bulb.
4. Replace glass shield over bulb and snap wire holder into place.
5. Turn power back on again at the main source (or plug the range back in).
6. The clock will then need to be reset. To reset, see **Setting the Clock and Minute Timer** in this Use & Care Manual.

## CARE & CLEANING

### Removing and replacing the lift-off oven door

#### CAUTION

- To avoid possible injury when removing or replacing the oven door, follow the instructions below carefully and always hold the oven door with both hands positioned away from the door hinge area.
- The door is heavy. For safe, temporary storage, lay the door flat with the inside of the door facing down.

#### To remove oven door:

1. Open oven door completely (horizontal with floor - See Fig. 1).
2. Pull the door hinge locks on both left and right door hinges down from the oven frame completely towards the oven door to unlock (See Fig. 2). A tool such as a small flat-blade screwdriver may be required.
3. Firmly grasp both sides of oven door along the door sides (Do not use the oven door handle).
4. Close the door to the broil stop position. The oven door will stop into this position just before fully closing.
5. With the oven door in the broil stop position (Fig. 3), slightly lift and carefully pull the oven door away from the oven frame. To avoid finish damage, be careful not to allow the oven door hinges to contact the oven front frame.

#### To replace oven door:

1. Firmly grasp both sides of oven door along the door sides (Do not use the oven door handle).
2. Holding the oven door at the same angle as the removal position (See Fig. 3), carefully line up and insert both door hinge arms between the pins located on each side of the oven door frame (See Fig. 4).
3. With both door hinge arms in place, open the oven door (horizontal with floor - See Fig. 1).
4. Push the door hinge locks up towards and into the oven frame for both left and right oven door hinges to the locked position (See Fig. 2).
5. Close the oven door.

#### Special door care instructions - Most oven doors contain glass that can break.

#### Read the following recommendations:

1. DO NOT close the oven door until all the oven racks are fully positioned into the oven interior.
2. Do not hit the glass with pots, pans, or any other object.
3. Scratching, hitting, jarring or stressing the glass may weaken its structure causing an increased risk of breakage at a later time.

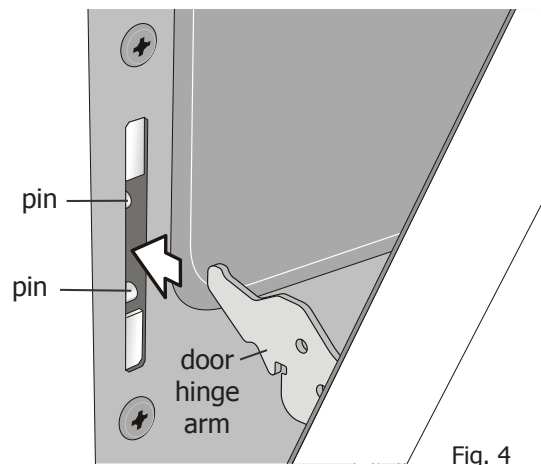
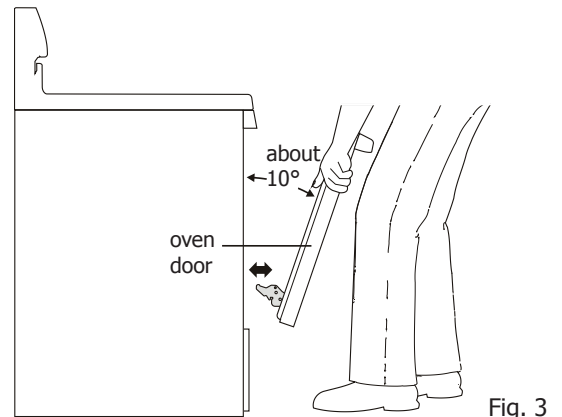
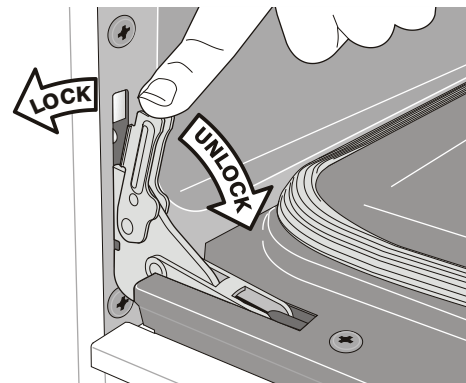
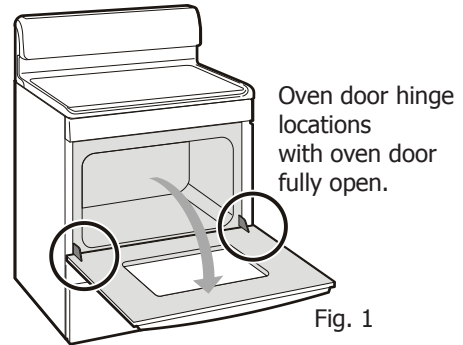

<b>Problem</b>	<b>Solution</b>
Oven control beeps and displays an <b>F code</b> (fault code) error.	<ul style="list-style-type: none"> <li>• The oven control has detected a fault or error condition. Press <b>clear off</b> to clear the display &amp; stop beeping. Try the <b>bake</b> or <b>broil</b> feature again. If the F code error repeats, remove electric power from appliance, wait 5 minutes and then <b>repower</b> appliance and set clock for the time of day. Try the bake or broil feature again. If the fault recurs, record fault and call your authorized service agent.</li> </ul>
Poor baking results.	<ul style="list-style-type: none"> <li>• Allow oven to preheat to the set temperature before placing food in oven.</li> <li>• Make sure the proper oven rack position is used. Adjust if needed.</li> <li>• Center food in the oven and space pans to allow air to circulate.</li> <li>• Try adjusting the recipe's recommended temperature or baking time.</li> <li>• If you feel the oven is too hot or cool, see "Adjusting oven temperature" in <b>Setting Oven Controls</b> section.</li> </ul>
Appliance is not level.	<ul style="list-style-type: none"> <li>• Be sure floor is level, strong &amp; stable enough to support the appliance. If floor is sagging or sloping, contact a carpenter to correct the problem.</li> <li>• Cooktop or oven racks not level. To correct, place oven rack in center of oven. Place a spirit level on the oven rack. Adjust by turning leveling legs at base of appliance until the oven rack rests level.</li> <li>• Kitchen cabinet alignment may make range appear not level. Be sure cabinets are square &amp; have sufficient room for appliance clearance.</li> </ul>
Cannot move appliance easily. Appliance must be accessible for service.	<ul style="list-style-type: none"> <li>• Cabinets not square or are built in too tightly to appliance sides. Contact builder or installer to make appliance accessible.</li> <li>• Carpet interferes with appliance. Provide sufficient space so appliance may be lifted over carpet.</li> </ul>
Entire appliance does not operate.	<ul style="list-style-type: none"> <li>• Make sure power cord is plugged correctly into outlet.</li> <li>• Electrical power outage. Check house lights to be sure. Call your local electric company for service.</li> <li>• Service wiring is not complete. Contact your dealer, installing agent or authorized service agent.</li> </ul>
Oven portion of appliance does not operate.	<ul style="list-style-type: none"> <li>• Be sure the oven controls are set properly for the desired cooking feature. See <b>Setting Oven Controls</b> section in this manual or see "Entire appliance does not operate" in this checklist.</li> <li>• The time of day is not set. The time of day <b>must</b> first be set in order to properly operate some of the oven features. See "Setting the clock" in <b>Setting Oven Controls</b> section.</li> </ul>
Surface element does not heat cookware.	<ul style="list-style-type: none"> <li>• Lightweight or warped pans used. Use only flat, evenly balanced, medium or heavyweight quality cookware. Flat pans heat better than warped pans. Cookware materials and weight of the material affect heating. Heavy &amp; medium-weight pans heat evenly. Because lightweight pans heat unevenly, foods may burn easily.</li> </ul>
Surface element seems too hot or not hot enough.	<ul style="list-style-type: none"> <li>• Incorrect control setting. Be sure the matching control is set for the surface element that you are attempting to use or adjust power level setting.</li> </ul>

## BEFORE YOU CALL • Solutions to common problems

Problem	Solution
Flames inside oven or smoking from oven vent.	<ul style="list-style-type: none"><li>• Excessive spillovers in oven. For example this may happen for pie spillovers or large amounts of grease left on the oven bottom. Wipe up excessive spillovers before starting oven. If flames or excessive smoke are present see <b>Setting broil</b> instructions in the "Setting Oven Controls" section for additional recommendations.</li></ul>
Oven smokes excessively when broiling.	<ul style="list-style-type: none"><li>• Incorrect setting or food preparation. See <b>Setting broil</b> instructions in "Setting Oven Controls" section.</li><li>• Make sure oven door is open to broil stop position.</li><li>• Food positioned too close to upper element. Reposition the food item lower if necessary to provide proper clearance between the food &amp; the broil element. Try preheating the oven before broiling.</li><li>• Food not properly prepared. Remove excess fat from meat. Cut remaining fatty edges to prevent curling.</li><li>• Broil pan and insert (some models) wrong side up and grease not draining. Always place insert on top of broil pan with ribs up &amp; slots down to allow excess grease to drip into broil pan.</li><li>• Do not use aluminum foil. Aluminum foil will trap grease, expose grease to high temperatures and increase smoking.</li><li>• Grease has built up on interior oven surfaces. Regular cleaning is necessary if broiling frequently. Old grease or food spatters cause excessive smoking.</li></ul>
Convection does not work (some models)	<ul style="list-style-type: none"><li>• Oven control not set properly. Review instructions for <b>Quick bake</b> in "Setting Oven Controls" section.</li><li>• See "Convection fan does not rotate" in this checklist.</li></ul>
Convection fan does not rotate (some models)	<ul style="list-style-type: none"><li>• Oven door is open. The convection fan will turn off if oven door is opened when any convection feature is active. Close oven door.</li></ul>
Self-cleaning cycle does not work.	<ul style="list-style-type: none"><li>• Oven control not set properly for self-clean. Follow the instructions provided in the <b>Clean</b> section of this manual.</li><li>• Self-clean cycle was interrupted. Refer to the <b>Clean</b> section for more detailed information.</li></ul>
Soil not completely removed after running a self-cleaning cycle.	<ul style="list-style-type: none"><li>• Dirty front oven frame outside oven door gasket area. These areas are not within the self-cleaning area, but get hot enough to burn on residue. Manually clean these areas <b>before</b> starting a self-clean cycle.</li><li>• Excessive food spillovers inside oven. Wipe up spillovers before starting a self-clean cycle.</li></ul>
Oven light does not work.	<ul style="list-style-type: none"><li>• See <b>Replacing the interior oven light</b> in the "Care &amp; Cleaning" section. Also be sure the oven light bulb is secure in the socket.</li></ul>

<b>Problem</b>	<b>Solution</b>
Scratches or abrasions on cooktop surface.	<ul style="list-style-type: none"><li>• Coarse particles such as salt or sand between cooktop and utensils can cause scratches. Be sure cooktop surface and bottoms of utensils are clean before usage. Small scratches do not affect cooking and will become less visible with time.</li><li>• Cleaning materials not recommended for ceramic-glass cooktop have been used. See "Cooktop Cleaning" and "Cooktop Maintenance" in the <b>Care and Cleaning</b> section of this Use &amp; Care Guide.</li><li>• Cookware with rough bottom has been used. Use smooth, flat-bottomed cookware.</li></ul>
Metal marks on the cooktop.	<ul style="list-style-type: none"><li>• Sliding or scraping of metal utensils on cooktop surface. Always lift cooking utensils from cooktop surface. Use a ceramic-glass cooktop cleaning creme to remove the marks. See "Cooktop Cleaning" and "Cooktop Maintenance" in the <b>Care &amp; Cleaning</b> section.</li></ul>
Brown streaks or specks on cooktop.	<ul style="list-style-type: none"><li>• Spillovers are burnt onto ceramic surface. Use a razor blade scraper to remove soil. See "Cooktop Cleaning" and "Cooktop Maintenance" in the <b>Care &amp; Cleaning</b> section.</li></ul>
Areas of discoloration with metallic sheen on cooktop surface.	<ul style="list-style-type: none"><li>• Mineral deposits from water and food. Remove using a ceramic-glass cooktop cleaning creme. Always use cookware with clean, dry bottoms.</li></ul>

## MAJOR APPLIANCE WARRANTY

Your appliance is covered by a one year limited warranty. For one year from your original date of purchase, Electrolux will pay all costs for repairing or replacing any parts of this appliance that prove to be defective in materials or workmanship when such appliance is installed, used and maintained in accordance with the provided instructions.

### **Exclusions This warranty does not cover the following:**

- 1 Products with original serial numbers that have been removed, altered or cannot be readily determined.
- 2 Product that has been transferred from its original owner to another party or removed outside the USA or Canada.
- 3 Rust on the interior or exterior of the unit.
- 4 Products purchased "as-is" are not covered by this warranty.
- 5 Food loss due to any refrigerator or freezer failures.
- 6 Products used in a commercial setting.
- 7 Service calls which do not involve malfunction or defects in materials or workmanship, or for appliances not in ordinary household use or used other than in accordance with the provided instructions.
- 8 Service calls to correct the installation of your appliance or to instruct you how to use your appliance.
- 9 Expenses for making the appliance accessible for servicing, such as removal of trim, cupboards, shelves, etc., which are not a part of the appliance when it is shipped from the factory.
- 10 Service calls to repair or replace appliance light bulbs, air filters, water filters, other consumable, or knobs, handles, or other cosmetic parts.
- 11 Surcharges including, but not limited to, any after hour, weekend, or holiday service calls, tolls, ferry trip charges, or mileage expense for service calls to remote areas, including the state of Alaska.
- 12 Damages to the finish of appliance or home incurred during installation, including but not limited to floors, cabinets, walls, etc.
- 13 Damages caused by: services performed by unauthorized service companies; use of parts other than genuine Electrolux parts or parts obtained from persons other than authorized service companies; or external causes such as abuse, misuse, inadequate power supply, accidents, fires, or acts of God.

### **DISCLAIMER OF IMPLIED WARRANTIES; LIMITATION OF REMEDIES**

Customer's sole and exclusive remedy under this limited warranty shall be product repair or replacement as provided herein. Claims based on implied warranties, including warranties of merchantability or fitness for particular purpose, are limited to one year or the shortest period allowed by law, but not less than one year. Electrolux shall not be liable for consequential or incidental damages such as property damage and incidental expenses resulting from any breach of this written limited warranty or any implied warranty. Some states and provinces do not allow the exclusion or limitation of incidental or consequential damages, or limitations on the duration of implied warranties, so these limitations or exclusions may not apply to you. This written warranty gives you specific legal rights. You may also have other rights that vary from state to state.

### **If You Need Service**

Keep your receipt, delivery slip, or some other appropriate payment record to establish the warranty period should service be required. If service is performed, it is in your best interest to obtain and keep all receipts. Service under this warranty must be obtained contacting Electrolux at the addresses or phone numbers below.

This warranty only applies in the USA and Canada. In the USA, your appliance is warranted by Electrolux Major Appliances North America, a division of Electrolux Home Products, Inc. In Canada, your appliance is warranted by Electrolux Canada Corp. Electrolux authorizes no person to change or add to any obligations under this warranty. Obligations for service and parts under this warranty must be performed by Electrolux or an authorized service company. Product features or specifications as described or illustrated are subject to change without notice.

**USA**  
**1.800.944.9044**  
**Electrolux Major Appliances**  
**North America**  
**P.O. Box 212378**  
**Augusta, GA 30907**



**Canada**  
**1.800.265.8352**  
**Electrolux Canada Corp.**  
**5855 Terry Fox Way**  
**Mississauga, Ontario, Canada**  
**L5V 3E4**