

FRIGIDAIRE

All about the

Use & Care

of your Wall Oven



TABLE OF CONTENTS

Product Record and Registration	2	Setting Oven Controls	13
Important Safety Instructions	3	Care and Cleaning	33
Cooking Recommendations	8	Before You Call	38
Before Setting Oven Controls	11	Warranty	41

A00538206 Rev B (November 2018)

PRODUCT RECORD AND REGISTRATION

Need Help?	2
Product Registration	2
Product Record and Registration	2
Important Safety Instructions	3
Cooking Recommendations	8
Before Setting Oven Controls	11
Setting Oven Controls	13
Care and Cleaning	33
Before You Call	38
Warranty	41

Need Help?

Visit the Frigidaire web site at www.frigidaire.com

Before you call for service, there are a few things you can do to help us serve you better.

Read this Use & Care Manual

This manual contains instructions to help you use and maintain your oven properly.

If You Received a Damaged Oven...

Immediately contact the dealer (or builder) that sold you the oven.

Save Time and Money

Check "[Solutions to Common Problems](#)" on page 39. This section helps step you through some common problems that might occur.

If you do need service, help is only a phone call away. Call Frigidaire customer services at **1-800-944-9044**.

Product Registration

Registering your product with Frigidaire enhances our ability to serve you. You can register online at <http://www.frigidaire.com> or by dropping your product registration card in the mail.

Record model and serial numbers here

Purchase Date: _____

Frigidaire model number: _____

Frigidaire serial number: _____

Serial Plate Location

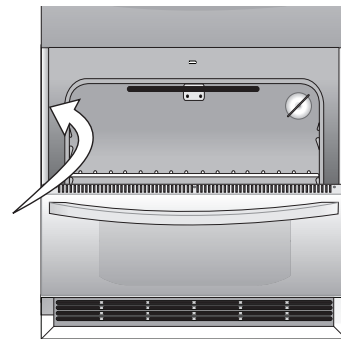

Questions?

For toll-free telephone support in the U.S. and Canada call **1-800-944-9044**

For online support and product information visit <http://www.frigidaire.com>.

Thank you for choosing Frigidaire.

This Use & Care manual is part of our commitment to customer satisfaction and product quality throughout the service life of your new appliance. We view your purchase as the beginning of a relationship. To ensure our ability to continue serving you, please use this page to record important product information.

IMPORTANT SAFETY INSTRUCTIONS

Read all instructions before using this appliance.

This manual contains important safety symbols and instructions. Please pay attention to these symbols and follow all instructions given.

Do not attempt to install or operate your appliance until you have read the safety precautions in this manual. Safety items throughout this manual are labeled with a **WARNING** or **CAUTION** statement based on the risk type.

Warnings and important instructions appearing in this guide are not meant to cover all possible conditions and situations that may occur. Common sense, caution, and care must be exercised with installing, maintaining, or operating your appliance.

DEFINITIONS



This is the safety alert symbol. It is used to alert you to potential personal injury hazards. Obey all safety messages that follow this symbol to avoid possible injury or death.

WARNING

Indicates a potentially hazardous situation which, if not avoided, may result in death or serious injury.

CAUTION

Indicates a potentially hazardous situation which, if not avoided, may result in minor or moderate injury.

IMPORTANT

Indicates installation, operation, maintenance, or valuable information that is not hazard related.

NOTE

Indicates a short, informal reference-something written down to assist the memory or for future reference.

WARNING

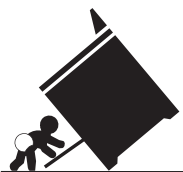

Tip Over Hazard

- A child or adult can tip the oven and be killed.
- Install the anti-tip device to oven and/or structure per installation instructions.
- Ensure the anti-tip device is re-engaged when the oven is moved.
- Do not operate the oven without the anti-tip device in place and engaged.
- Failure to follow these instructions can result in death or serious burns to children and adults.

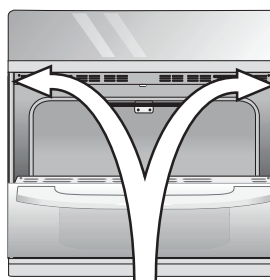

Anti-tip mounting holes

Refer to the installation instructions supplied with your appliance for proper installation.

Check for proper installation with a visual check that the anti-tip screws are present. Test the installation with light downward pressure on the open oven door. The oven should not tip forward.

IMPORTANT

Save these instructions for future reference.

IMPORTANT SAFETY INSTRUCTIONS

IMPORTANT INSTRUCTIONS FOR UNPACKING AND INSTALLATION

IMPORTANT

Read and follow the below instructions and precautions for unpacking, installing, and servicing your appliance:

Remove all tape and packaging before using the appliance. Destroy the carton and plastic bags after unpacking the appliance. Never allow children to play with packaging material. Do not remove the wiring label and other literature attached to the range. Do not remove model/serial number plate.

Cold temperatures can damage the electronic control. When using this appliance for the first time, or when the appliance has not been used for an extended period of time, be sure the appliance has been in temperatures above 32°F (0°C) for at least 3 hours before turning on the power to the appliance.

Never modify or alter the construction of the appliance by removing the leveling legs, panels, wire covers, anti-tip brackets/screws, or any other part of the appliance.

Be sure to have an appropriate foam-type fire extinguisher available, visible, and easily accessible located near the appliance.

GROUNDING INSTRUCTIONS

WARNING

Avoid fire hazard or electrical shock. Failure to follow this warning may cause serious injury, fire, or death.

Avoid fire hazard or electrical shock. Do not use an adapter plug, use an extension cord, or remove grounding prong from the power cord. Failure to follow this warning may cause serious injury, fire, or death.

Proper Installation—Be sure your appliance is properly installed and grounded by a qualified technician. In the United States, install in accordance with the National Fuel Gas Code ANSI Z223.1/NPFA No. 54, latest edition and National Electrical Code NFPA No. 70 latest edition, and local electrical code requirements. In Canada, install in accordance with CAN/CGA B149.1 and CAN/CGA B149.2 and CSA Standard C22.1, Canadian Electrical code, Part 1-latest editions and local electrical code requirements. Install only per installation instructions provided in the literature package for this appliance.

For personal safety, this appliance must be properly grounded. For maximum safety, the power cord must be securely connected to an electrical outlet or junction box that is the correct voltage, is correctly polarized and properly grounded, and protected by a circuit breaker in accordance with local codes.

It is the personal responsibility of the consumer to have the appropriate outlet or junction box with the correct, properly grounded wall receptacle installed by a qualified electrician. It is the responsibility and obligation of the consumer to contact a qualified installer to assure that the electrical installation is adequate and is in conformance with all local codes and ordinances.

See the installation instructions packaged with this appliance for complete installation and grounding instructions.

Save these instructions for future reference

IMPORTANT SAFETY INSTRUCTIONS

IMPORTANT INSTRUCTIONS FOR USING THE APPLIANCE

WARNING

Storage In or On Appliance—Flammable materials should not be stored in an oven, near surface burners, or in the warmer drawer (if equipped). This includes paper, plastic, and cloth items, such as cookbooks, plastic ware, and towels, as well as flammable liquids. Do not store explosives, such as aerosol cans, on or near the range.

Do not leave children alone - Children should not be left alone or unattended in the area where the appliance is in use. They should never be allowed to sit or stand on any part of the appliance, including the storage drawer, lower broiler drawer, or lower double oven.

Do not store items of interest to children in the cabinets above the range. Children climbing on the range to reach items could be seriously injured.

Do not allow children to climb or play around the appliance. The weight of a child on an open oven door may cause the appliance to tip, resulting in serious burns or other injury. An open drawer when hot may cause burns.

Stepping, leaning, or sitting on the door or drawers of this appliance can result in serious injuries and also cause damage to the appliance.

WARNING

Never cover any slots, holes, or passages in the oven bottom or cover an entire oven rack with materials such as aluminum foil or aftermarket oven liners. Doing so blocks air flow through the oven and may result in carbon monoxide poisoning. Aluminum foil linings may trap heat, causing a fire hazard.

Do not use oven or warmer drawer (if equipped) for storage.

Never use your appliance as a space heater to heat or warm the room. Doing so may result in carbon monoxide poisoning and overheating of the appliance.

CAUTION

When heating fat or grease, watch it closely. Grease may catch fire if it becomes too hot.

Do not use water or flour on grease fires. Smother fire or flame or use dry chemical or foam-type extinguisher. Cover the fire with a pan lid or use baking soda.

Use dry potholders. Moist or damp potholders on hot surfaces may result in burns from steam. Do not let potholders touch hot cooking areas. Do not use towels or other bulky cloths.

Do not heat unopened food containers - Build-up of pressure may cause container to burst and result in injury.

Wear proper apparel - Loose-fitting or hanging garments should never be worn while using the appliance. Do not let clothing or other flammable materials contact hot surfaces.

IMPORTANT SAFETY INSTRUCTIONS

CAUTION

Do not touch surface burners or elements, areas near these burners or elements, interior surfaces of the oven, or the warmer drawer (if equipped). Surface burners and elements may be hot even though they appear cool. Areas near surface burners and elements may become hot enough to cause burns. During and after use, do not touch, or let clothing or other flammable materials touch these areas until they are cool. These areas may include the cooktop, surfaces facing the cooktop, oven vent areas, oven door, and oven window.

Do not attempt to operate the appliance during a power failure. If the power fails, always turn off the appliance. If the appliance is not turned off and the power resumes, electric surface elements may resume operation when power is restored. Once the power resumes, reset the clock and the oven function.

Keep oven vent ducts unobstructed. Touching surfaces in this area when the oven is on may cause severe burns. Do not place plastic or heat-sensitive items on or near the oven vent. These items can melt or ignite.

Placement of oven racks - Always place oven racks in desired location while oven is cool. If rack must be moved while oven is hot, do not let potholder contact hot burner or element in oven. Use potholders and grasp the rack with both hands to reposition. Remove all cookware and utensils before moving the rack.

Do not use a broiler pan without its insert. Broiler pans and inserts allow dripping fat to drain away from the high heat of the broiler. Do not cover the broiler insert with aluminum foil; exposed fat and grease could ignite.

Do not cook food on the oven bottom. Always cook in proper cookware and always use the oven racks.

IMPORTANT INSTRUCTIONS FOR USING YOUR OVEN

Protective liners—Do not use aluminum foil, after-market oven liners, or any other materials or devices to line oven bottom, oven racks, or any other part of the appliance. Only use aluminum as recommended for baking, such as lining cookware or as a cover placed on food. Any other use of protective liners or aluminum foil may result in a risk of electric shock or fire or a short circuit.

Use care when opening oven door, lower oven door, or warmer drawer (some models). Stand to the side of the appliance when opening the door of a hot oven. Let hot air or steam escape before you remove or replace food in the oven.

Save these instructions for future reference

IMPORTANT SAFETY INSTRUCTIONS

IMPORTANT INSTRUCTIONS FOR CLEANING YOUR APPLIANCE

CAUTION

Before manually cleaning any part of the appliance, be sure all controls are turned off and the range is cool. Cleaning a hot oven can cause burns.

Clean the appliance regularly to keep all parts free of grease that could catch fire. Do not allow grease to accumulate. Greasy deposits in the fan could catch fire.

Always follow the manufacturer's recommended directions for use of kitchen cleaners and aerosols. Be aware that excess residue from cleaners and aerosols may ignite causing damage and injury.

Clean ventilating hoods frequently - Grease should not be allowed to accumulate on hood or filter. Follow the manufacturer's instructions for cleaning vent hoods.

IMPORTANT INSTRUCTIONS FOR SELF CLEANING OVENS

Do not clean the oven door gasket. The door gasket is essential for a good seal. Care should be taken not to rub, damage, or move the gasket.

Do not use oven cleaners. No commercial oven cleaner or oven liner protective coating of any kind should be used in or around any part of the appliance.

Use the self clean cycle to clean only the parts listed in this manual.

Before using self clean, remove the broiler pan, any food, utensils, and cookware from the oven, storage drawer or warming drawer (if equipped). Remove oven racks unless otherwise instructed.

Some birds are extremely sensitive to the fumes given off during the self clean cycle of any oven. Move birds to another well-ventilated room.

IMPORTANT INSTRUCTIONS FOR SERVICE AND MAINTENANCE

Do not repair or replace any part of the appliance unless specifically recommended in the manuals. All other servicing should be done only by a qualified technician. This reduces the risk of personal injury and damage to the appliance.

Always contact your dealer, distributor, service agent, or manufacturer about problems or conditions you do not understand.

Ask your dealer to recommend a qualified technician and an authorized repair service. Know how to disconnect the power to the appliance at the circuit breaker or fuse box in case of emergency.

Remove the oven door from any unused oven if it is to be stored or discarded.

Do not touch a hot oven light bulb with a damp cloth. Doing so could cause the bulb to break. Handle halogen lights (if equipped) with paper towels or soft gloves. Disconnect the appliance or shut off the power to the appliance before removing and replacing the bulb.



WARNING

California Residents: for cancer and reproductive harm information, visit www.P65Warnings.ca.gov

COOKING RECOMMENDATIONS

Bakeware

The material of bakeware affects how evenly and quickly it transfers heat from the pan to the food.

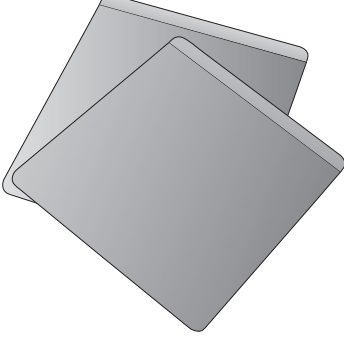
Material	Attributes	Recommendation
Shiny metal bakeware 	Shiny, aluminum, and non-coated bakeware is the best for even heating. It is suitable for all baked goods.	Recommended cooking temperatures and times are based on shiny metal bakeware.
Dark metal bakeware 	Dark bakeware cooks hotter than shiny bakeware.	Reduce the cooking temperature by 25° F (13-14° C) when using dark bakeware.
Glass bakeware 	Glass bakeware cooks hotter than shiny bakeware. Glass is convenient, as the same piece of bakeware can be used for cooking, serving, and storing food.	Reduce the cooking temperature by 25° F (13-14° C) when using glass bakeware.
Insulated bakeware 	Insulated bakeware cooks cooler than shiny bakeware. Insulated bakeware is designed for baking in gas ovens.	Increase the cooking temperature by 25° F (13-14° C) when using insulated bakeware.

COOKING RECOMMENDATIONS

Cooking Conditions

Conditions in your kitchen can affect the performance of your appliance when cooking food.

Condition	Attributes	Recommendation
Aging cookware	As pans age and become discolored, cooking times may need to be reduced slightly.	If food is too dark or overcooked, use the minimum cook time in the recipe or packaging. If food is too light or undercooked, use the middle to maximum cook time in the recipe or packaging.
High altitude	Air is drier and air pressure is lower. Water boils at a lower temperature, and liquids evaporate faster. Foods may take longer to bake. Doughs may rise faster.	Adjust cooking temperature, cooking time, or recipes as needed. Increase amount of liquid in baking recipes. Increase cook time on cooktop. Cover dishes to reduce evaporation. Increase bake time or oven temperature. Reduce amount of baking soda or baking powder in recipe. Reduce rising time or punch down dough and allow it to rise twice.

Cooking Results

Small adjustments may fix a problem with food not being as done as you like or more done than you like.

Result	Recommendation
Food too light	Use the middle to maximum cook time recommended on packaging or recipe.
Food too dark	Use the minimum cook time recommended on packaging or recipe.

Cooking Tips

Use these additional tips to get the best results from your appliance.

Cooking	Tips
Baking	
Rack placement	Follow the instructions in “Oven Control Features” on starting on page 13 . When using only one rack, place the rack so the food is in the center of the oven.
Preheat	Fully preheat the oven before baking items like cookies, cakes, biscuits and breads. Insert food immediately after the beep.
Checking food	Use the window and oven light when checking food. Opening the door may reduce baking performance.
Bake or Convection Bake	Convection bake is the best function to use for baking on multiple racks. For best performance, see “Convection Bake” on page 18 .

COOKING RECOMMENDATIONS

Cooking	Tips
Food placement	Allow at least 2 inches (5 cm) of space between bakeware for proper air circulation.
Broiling / Roasting	
Broiling pan	<p>For best results when broiling, use a broil pan with a broil pan insert designed to drain the fat from the food, help avoid spatter, and reduce smoking. The broiler pan will catch grease spills, and the insert helps prevent grease splatters.</p> <p>If a broiler pan and insert are not supplied with this appliance, they may be purchased from Frigidaire.com.</p>
Convection Cooking	
Convection attributes	<p>Convection cooking uses a fan to circulate hot air around the oven and food. It browns food more evenly and reduces hot spots in the oven.</p> <p>Convection saves time when using multiple racks or cooking several food items at once.</p>
Convection bake	<p>Reduce cooking temperature by 25° F (13-14° C) from the recipe unless the recipe is written for convection baking.</p> <p>Preheat the oven for best results.</p>
Convection roast	<p>Convection roast is best for meats and does not require preheating for most meats and poultry.</p> <p>Reducing the cooking temperature for convection roast is not recommended. Carefully follow your recipe's temperature and time recommendations, adjusting the cooking time if the recipe does not specify convection roasting time.</p> <p>Since convection roast cooks faster, cook time may be reduced by 25% to 40% depending on food type. You can reduce cook times by 25% from the recommended time of your recipe, and check the food at this time. If needed, continue cooking until the desired doneness is obtained.</p> <p>Use a meat probe if available with your appliance. Meat probes are also available from most grocery and home goods stores.</p> <p>Arrange oven racks so large cuts of meat and poultry are on the lowest rack of the oven.</p> <p>Do not cover foods when dry roasting - covering will prevent the meat from browning properly.</p> <p>When cooking meats, use the broiler pan and insert or a roasting rack. The broiler pan will catch grease spills and the insert helps prevent grease splatters. If you do not have one of these accessories, they may be purchased from Frigidaire.com.</p>

BEFORE SETTING OVEN CONTROLS

Oven Vent Location

The oven is vented as shown below. When the oven is on, warm air is released through the vent. This venting is necessary for proper air circulation in the oven and good baking results. Do not block oven vent. Never close off the openings with aluminium foil or any other material. Steam or moisture may appear near the oven vent; this is normal.

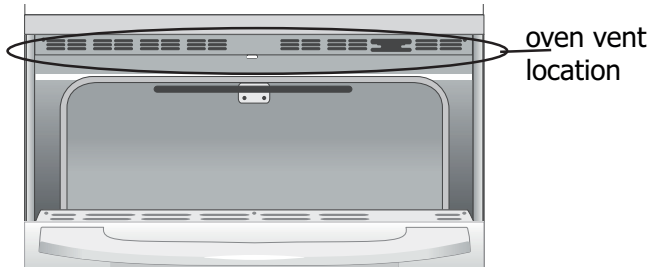

Figure 1: Do not block oven vent location

Types of oven racks

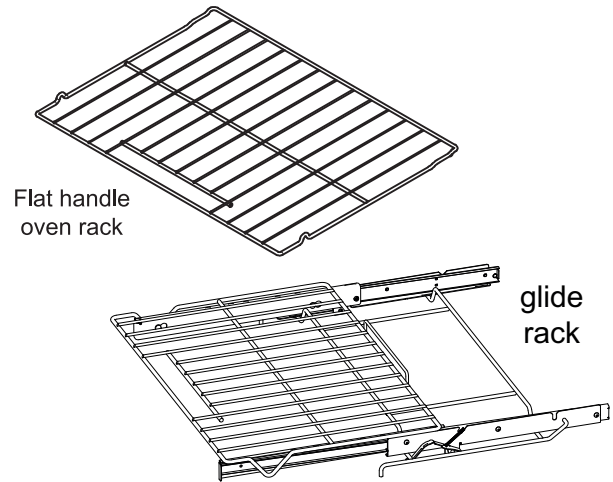

Figure 2: Oven rack types

- **Flat oven racks** may be used for most cooking needs and may be placed in most oven rack positions.
- The fully extendable **glide rack** makes food preparation easier. This oven rack has glide tracks that allow the rack to be pulled away from the oven without rubbing the sides of the oven wall.

Removing, replacing, and arranging flat or offset oven racks

To arrange - Always arrange the oven racks when the oven is cool (prior to operating the oven).

To remove - Pull the oven rack straight forward until it reaches the stop position. Lift up front of oven rack slightly and slide out.

To replace - Place the oven rack on the rack guides on both sides of oven walls. Tilt the front of oven rack upward slightly and slide the oven rack back into place. Be sure oven racks are level before using.

CAUTION

Always use pot holders or oven mitts when using the oven. When cooking, the oven interior and exterior, oven racks, and cooktop will become very hot which can cause burns.

WARNING

Protective Liners — Do not use aluminum foil or any other materials to line the oven bottom, walls, racks or any part of the oven. Only use aluminum foil as recommended in this manual. Improper installation of these liners may result in risk of electric shock or fire.

IMPORTANT

All oven racks should be removed before a self clean operation. Racks left in the oven during the high heat of the self clean function can easily discolor.

The ability of the racks to easily slide in and out along the rack positions may also be affected.

BEFORE SETTING OVEN CONTROLS

Removing and Replacing the Glide Racks

The fully extendable Glide rack makes food preparation easier. This oven rack has glide tracks that allow the rack to be pulled away from the oven without rubbing the sides of the oven wall.

To remove - Make sure the baking rack is in the closed position. Using one hand, reach through handle opening and grasp both the upper and lower portions of the glide rack as shown in [Figure 3](#).

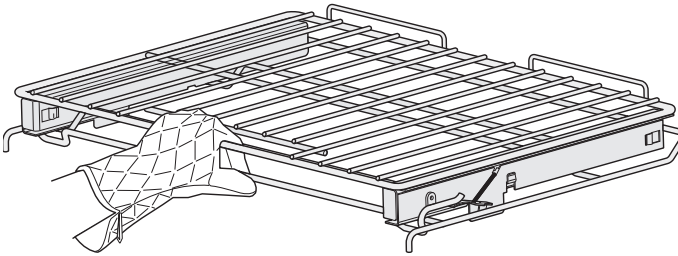

Figure 3: Grasp both rack sections

While holding both sections, pull the glide rack out of the oven until the stop position is reached ([Figure 4](#)).

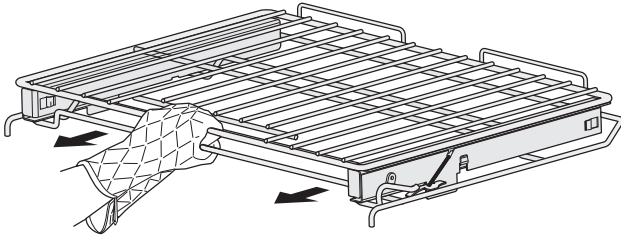

Figure 4: Pull rack to stop position

Using both hands, lift up the front of the rack slightly and continue to pull the rack away from the oven ([Figure 5](#)). Be sure to grasp both upper and lower rack portions together when removing or handling the glide rack.

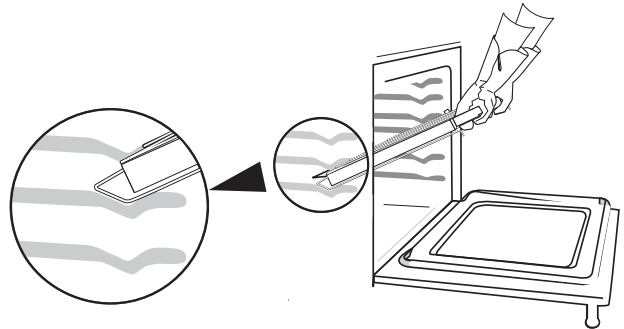

Figure 5: Remove and replace using both hands

The rack portions move independently and are difficult to handle unless held together.

To replace - Make sure the baking rack is in the closed position. Grasp both upper and lower portions of glide rack. Lift and hold the rack level between the oven cavity walls. Tilt the front of the rack upward slightly and slide the rack completely into position.

Important: To prevent possible damage to the oven, do not attempt to close the oven door until all the oven racks are fully positioned back inside the oven cavity.

➔ IMPORTANT

Do not line the oven walls, racks, bottom or any other parts of the oven with aluminum foil or with any other materials or oven liners. Doing so will alter heat distribution and may cause permanent damage to the oven interior. During clean the oven temperatures will be hot enough to melt foil.

⚠ CAUTION

Remove all oven racks and clean according to instructions provided in the Care & Cleaning section of this manual. Never pick up hot oven racks or parts.

SETTING OVEN CONTROLS

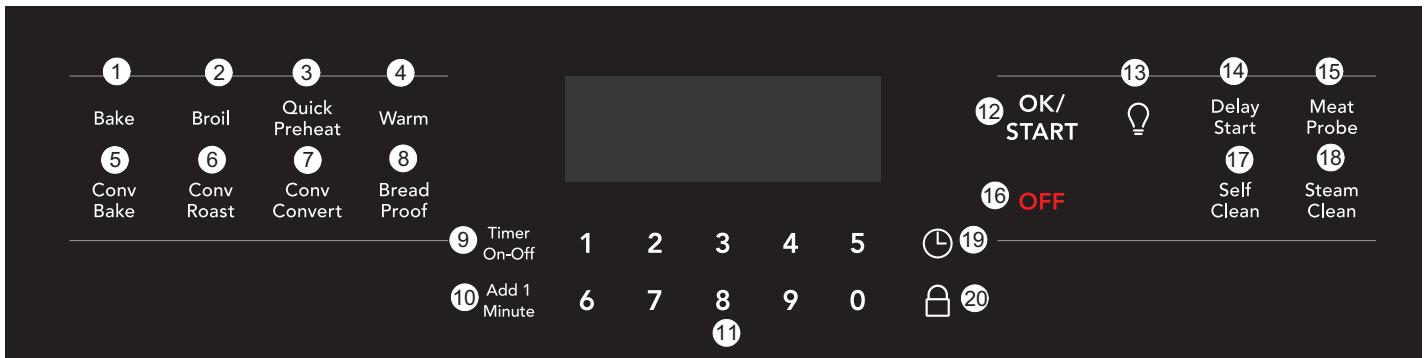

Oven Control Features

1. **Bake** - Use to enter normal baking temperatures for recipes that call for regular baking.
2. **Broil** - Selects normal broil function for direct heat cooking.
3. **Quick Preheat** - Best used for single rack baking with packaged, convenience, and made from scratch foods.
4. **Warm** - Use to keep cooked foods at serving temperature.
5. **Conv Bake** - Circulates the oven heat evenly and continuously for baking foods.
6. **Conv Roast** - Uses a convection fan to gently brown meats and poultry and seal in the juices.
7. **Convect Convert** - Converts standard bake temperatures to convection temperature in convection bake feature.
8. **Bread Proof** - Maintains a warm environment useful for rising of yeast-leavened products.
9. **Timer on-off** - Use to set or cancel the minute timer. The minute timer does not start or stop any cooking function.
10. **Add A Min** - Use to add additional minutes to the timer.
11. **0 through 9 keys** - Use to set temperature and set clock.
12. **OK/START** - Use to start cooking functions and when setting the clock.
13. **Oven Light** - Use to turn on internal light. Will turn on when the oven door is open.
14. **Delay Start** - Add to any cooking function and Self Clean to program a delayed starting time.
15. **Meat Probe** - Use when cooking meat like roasts, hams or poultry to cook to the desired internal temperature without any guesswork.
16. **OFF** - Use to turn off all cooking functions.
17. **Self Clean** - Use to set self-clean cycle between 2 and 4hrs.
18. **Steam Clean** - Use as a time saving method for cleaning light soils.
19. **Set Clock** - Use set the time of day
20. **Oven Lock** - Use to lock out oven controls.

Feature	Mode	Min.Temp. / Time	Max Temp. /Time
Quick Preheat		170°F (77°C)	550°F (288°C)
Bake		170°F (77°C)	550°F (288°C)
Broil		400°F (205°C)	550°F (288°C)
Conv Bake		170°F (77°C)	550°F (288°C)
Conv Roast		170°F (77°C)	550°F (288°C)
Meat Probe		140°F (60°C)	210°F (99°C)
Warm		170°F (77°C)	until canceled
Bread Proof		100°F (38°C)	until canceled
Timer		0:01 Min.	11:59 Hr./Min.
Clock Time	12 Hr.	1:00 Hr./Min.	12:59 Hr./Min.
	24 Hr.	0:00 Min	23:59 Hr./Min.
Delay Start	12 Hr.	1:00 Hr./Min.	12:59 Hr./Min.
	24 Hr.	0:00 Min	23:59 Hr./Min
Self Clean		2 hours	4 hours

Note: An entry acceptance tone (1beep) will sound each time a key is touched (the oven lock key is delayed 3 seconds). An entry error tone (3 short beeps) will sound if the entry of the temperature or time is below the minimum or above the maximum settings for the feature.

SETTING OVEN CONTROLS

Setting the Clock

When the appliance is first powered up, **12:00** will flash in the display (Figure 6). The time of day must first be set before operating the oven.



Figure 6: 12:00 in display before setting the clock

To Set Clock to 1:30:

1. Press .
2. Enter **1 3 0** using numeric keys.
3. Press **OK/START**.

Important note:

The clock cannot be changed when a Self Clean, Delay Start, or cooking feature is active.

Setting Timer

The minute timer allows you to track your cooking times without interfering with the cooking process. The timer may be set from a minimum time of 1 minute to a maximum of 11 hours and 59 minutes.

To set timer for 5 minutes:

1. Press **Timer on-off**.
2. Enter 5 using numeric keypad.
3. Press **Timer on-off** to start the timer. When set time ends, **END** will show in the display and the control will sound a beep three times every 30 seconds until **Timer on-off** key is pressed.

To cancel the timer when active, press **Timer on-off** again.

Important note:

- The timer does not start or stop the cooking process. It serves as an extra minute timer that will beep when the set time has run out. The timer may be used alone or while using any of the other oven functions.
- When timer is set for more than 1 hour it will display hours and minutes until 1 hour remains. When less than 1 hour remains, the display counts down in minutes and seconds. With less than 1 minute remaining, only seconds will display.
- If the timer is active during a cooking process, the timer will show in the display. To view the status of any other active oven function, press the key of the cooking function once and it will appear in the display for a few seconds.

Add 1 Min

Use the **Add 1 Min** feature to set additional minutes to the timer. Each press of the key will add 1 additional minute. If Add a Min is pressed when the timer is not active, the timer will activate and begin counting down from 1 minute.

To add 2 minutes to the timer:

Press **Add 1 Min** twice.

Setting 12 Hour or 24 Hour display mode

The clock display mode allows you to select 12 hr or 24 hr modes. The factory pre-set clock display mode is 12 hours.

To set 12 hr or 24 hr display mode:

1. Press and hold  for 6 seconds.
2. Press **Self Clean** to toggle between **12 Hr day** or **24 Hr day** display modes (Figure 7).
3. Press **OK/START** to accept the choice



Figure 7: 12 Hr dAy and 24 Hr dAy settings

Changing between continuous bake setting or 12 hour energy saving

The oven control has a factory preset built-in 12 Hour Energy Saving feature that will turn off the oven if the oven is left on for more than 12 hours. The control may be programmed to override this feature to bake continuously.

To change between continuous bake or 12 hour energy saving feature:

1. Press and hold **Timer on-off** for 6 seconds
2. Press **Self Clean** to toggle between **12 Hour OFF** or **Stay On** feature (Figure 8).
3. Press **OK/START** to accept choice.



Figure 8: 12 hr energy saving (L) and continuous setting (R)

SETTING OVEN CONTROLS

Changing temperature display from Fahrenheit to Celsius

The electronic oven control is set to display °F when shipped from the factory. The display may be changed to show either °F or °C oven temperatures.

To change temperature display mode from °F to °C or from °C to °F:

1. Press and hold **broil** for 6 seconds.
2. Once **F (or C)** appears in the display, press **Self Clean** to toggle between Fahrenheit and Celsius temperature display modes (Figure 9).
3. Press **OK/START** to accept the choice.

Important note:

The oven temperature display cannot be changed during the cooking process or if a delay start has been set or self clean is active.



Figure 9: Display showing Fahrenheit and Celsius

Setting Silent or Audible Control mode

Silent mode allows the oven control to operate without audible tones. The control may be programmed for silent operation and later reset to operate with all the normal audible tones.

To set for silent or audible mode:

1. Press and hold **Delay Start** for 6 seconds.
2. Press the **Self Clean** key to toggle between **bBEEP On** or **bBEEP OFF** (Figure 10).
3. Press **OK/START** to accept the choice.



Figure 10: Display showing audible and silent operation

Setting Oven Lockout

The control can be programmed to lock the oven door and lockout the oven control keys.

To activate the oven lockout features:

1. Be sure oven door is completely closed.
2. Press and hold the lock key for 3 seconds. The motor driven door latch mechanism will begin locking the oven door automatically. Do not open the oven door. Allow about 15 seconds for the oven door to completely lock. Once door is locked, the word **DOOR** with a lock icon will appear in the display.

To cancel the oven lockout feature:

1. Press and hold the lock key for 3 seconds. The motor door latch will begin unlocking the oven door automatically. Do not open the oven door. Allow about 15 seconds for the oven door to completely unlock.
2. When the word **DOOR** with a lock icon no longer displays, the oven door may be opened, and the oven control keypad will be available for use.

Important note:

- If a control key is pressed when oven lockout is active, the control will triple beep indicating the key action is not available when the oven lockout feature is active.

Operating Oven Lights

The interior oven lights will automatically turn on when the oven door is opened. Oven lights will not operate during a self clean cycle or Sabbath. For best baking results, do not leave oven light on while cooking.

Press  to turn the interior oven lights on and off whenever the oven door is closed. The interior oven lights are located on the rear upper corner of the oven interior and are covered with a glass shield.

To replace the interior oven light, see ["Replacing the Oven Light"](#).



SETTING OVEN CONTROLS

Quick Preheat

Quick Preheat is available for single rack baking with packaged convenience foods and foods made from scratch and can be programmed for temperatures between 170°F and 550°F. Follow the recipe or package directions for food preparation time and temperature. When quick preheat is complete, a reminder tone will sound and food should be placed in the oven.

CAUTION

Always use pot holders or oven mitts when using the oven. When cooking the oven interior, oven racks, and cooktop will become very hot which can cause burns.

During quick preheat function, the bake element will cycle on and off. The convection fan will turn on while the oven is preheating and cycle on and off as needed during cooking. Depending on your preference for doneness cooking times may vary. Watch food closely.

Important:

- Always place food in center of the oven on rack position 2 Glide or 3 flat rack (Figure 12). Place the food as shown in Figure 11.
- For best results when baking batter and dough-based items such as cookies and pastries, use convection bake function and place food in oven when the reminder tone sounds signaling the oven is fully preheated.
- Food may need to be removed early and should be checked at minimum recommended bake time.

To set the preheat temperature for 350°F:

1. Arrange the interior oven racks.
2. Press **Quick Preheat**. 350 will appear in the display.
3. Press **OK/START**.
4. 350 and PREHEAT will be displayed while the oven is preheating and disappear once oven reaches set temperature.
5. Press **OFF** when baking is complete or to cancel the preheat feature.

To change preheat temperature while oven is preheating (ex: changing from 350°F to 425°F):

1. Press **Quick Preheat**. 350 will appear in the display.
2. Enter the new preheat temperature. Press **4 2 5**.
3. Press **OK/START**. 425 will show in the display.
4. When baking is complete, press **OFF**.

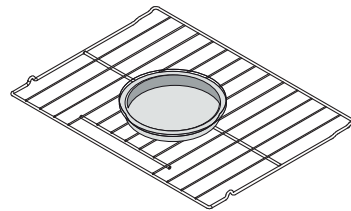

Figure 11: Single rack baking for convenience foods

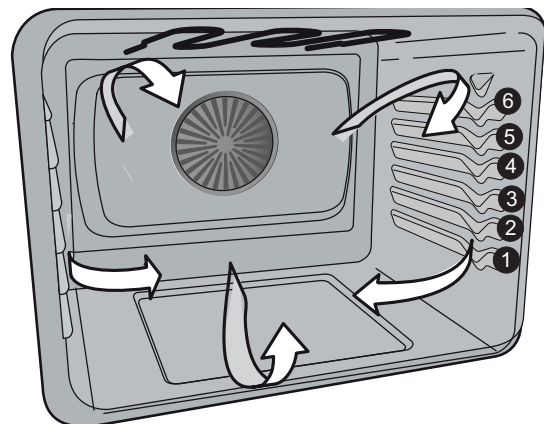

Figure 12: Oven rack positions

Note: The oven is equipped with a cooling fan that turns on when the oven reaches a high enough temperature and will remain on until the oven cavity has cooled. The cooling fans may remain on for a time after the oven function has been canceled. This is normal.

SETTING OVEN CONTROLS

Setting Bake

Bake cooks with heat that rises from the oven bottom. The heat and air circulate naturally in the oven. A reminder tone will sound indicating when the set bake temperature is reached and to place the food in the oven. The convection fan will turn on during preheat and then turn on and off as needed during the baking process.

Bake may be set for any oven temperature between 170°F (77°C) to 550°F (288°C).

CAUTION

Always use pot holders or oven mitts when using the oven. When cooking the oven interior, oven racks, and cooktop will become very hot which can cause burns.

Baking tips

- Fully preheat the oven before baking items like cookies, cakes, biscuits and breads.
- Use the convection bake function for best results when baking cookies on multiple racks.
- Bake is the best function to use for baking cakes.
- For best results when baking layer cakes using two oven racks, place racks in positions 1 flat and 4 glide and place pans as shown in [Figure 13](#).
- When using any single rack for baking cookies, cakes, biscuits, or muffins use rack position 3 flat or 2 glide.
- Allow at least 2 inches (5 cm) of space between bakeware for proper air circulation.
- Dark or dull bakeware absorbs more heat than shiny bakeware, resulting in dark or over browned foods. It may be necessary to reduce oven temperature or cook time to prevent overbrowning of some foods.
- Shiny pans are recommended for cakes, cookies, and muffins.
- Do not open oven door often. Opening the door will reduce the temperature in the oven and may increase cook time.

To set Bake for (default) oven temperature of 350°F:

1. Press **Bake**.
2. **350°** will appear in the display.
3. Press **OK/START**.

To cancel Bake at any time, press **OFF**.

To change the oven temperature to 425°F when the oven is baking:

1. Press **Bake**.
2. Enter new temperature of **4 2 5** using numeric keys.
3. Press **OK/START**.
4. To cancel Bake at any time, press **OFF**.

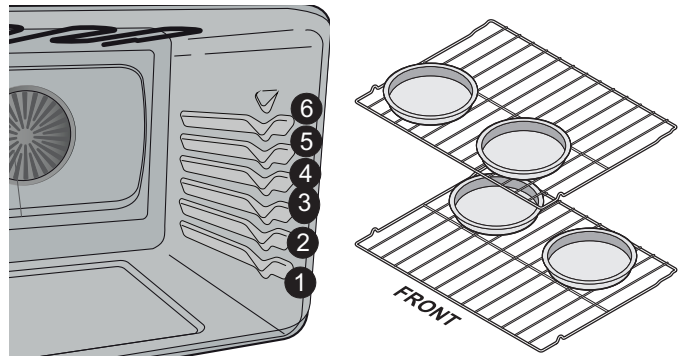

Figure 13: Rack positions and pan placement

Important: The oven will bake no longer than 12 hours. If you wish to bake for a longer period, see [“Changing between continuous bake setting or 12 hour energy saving”](#) on [page 14](#) for detailed information.

SETTING OVEN CONTROLS

Convection Bake

Convection Bake uses a fan to circulate the oven's heat uniformly around the oven. This improved heat distribution allows for even cooking and browning. Heated air flows around the food from all sides.

Convection bake may be set for any oven temperature between 170°F (77°C) and 550°F (288°C).

Benefits of convection cooking include:

- Multiple rack baking.

Baking tips

- Fully preheat the oven before baking items like cookies, cakes, biscuits and breads.
- When baking cakes using two oven racks place bakeware in positions 1 flat and 3 glide and place bakeware as shown in [Figure 14](#).
- When using any single rack for baking cookies, cakes, biscuits or muffins, use rack position 3 flat or 2 glide.
- Unless the recipe is written for convection cooking, use **Conv Convert** to reduce oven temperature from the recipe's recommended oven temperature.

To set convection bake with a default oven set temperature of 350°F:

1. Press **Conv Bake**.
2. **Conv Bake** and 350° will appear in the display.
3. Press **OK/START**. The convection fan will turn on and stay on during the cooking process.
4. To cancel convection bake at any time, press **OFF**.

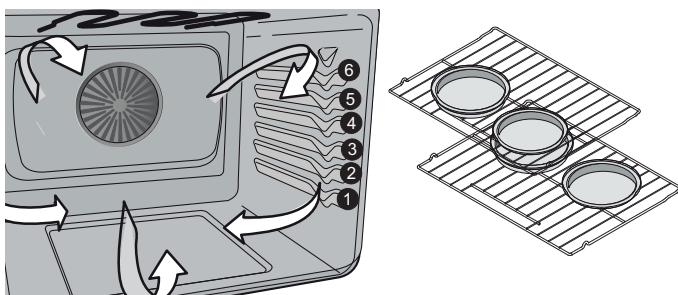

Figure 14: Rack positions and suggested pan placement [Figure 14](#)

Setting Convection Convert

Pressing the **Convect Convert** key automatically converts the cooking temperature entered for any standard baking recipe to the lower temperature required for convection baking.

To set the oven for convection bake with a standard baking recipe temperature of 400°F:

1. Arrange interior oven racks.
2. Press **Conv Bake**.
3. Press **4 0 0**.
4. Press **Conv Convert**.
5. Press **OK/START**.
6. Place food in the oven.

NOTE

Pressing **OFF** will stop the feature at any time.

Important note:

- Convection convert may only be used with the Convection Bake function.
- When using convection convert, bake time reductions may vary depending on the oven set temperature.
- If the oven door is opened when any convection function is active, the convection fan will stop rotating until the oven door is closed.
- Do not open the oven door often. Opening the door will reduce the temperature in the oven and may increase the cooking time necessary for best results.

CAUTION

Always use pot holders or oven mitts when using the oven. When cooking the oven interior, oven racks, and cooktop will become very hot which can cause burns.

SETTING OVEN CONTROLS

Setting Delay Start

Delay Start sets a delayed starting time to oven cooking or cleaning functions. Prior to setting a delay start, be sure the time of day is set correctly. Delay Start must be set while programming the cooking function.

WARNING

Food Poisoning Hazard. Do not let food sit for more than one hour before or after cooking. Doing so can result in food poisoning or sickness. Foods that can easily spoil such as milk, eggs, fish, meat or poultry, should be chilled in the refrigerator first. Even when chilled, they should not stand in the oven for more than 1 hour before cooking begins, and should be removed promptly when finished cooking.

To program oven for a delay start beginning at 5:30, and for baking at 375°F:

1. Press **Bake**. Enter **3 7 5** using numeric keypad.
2. Press **Delay Start**.
3. Enter **5 3 0** using numeric keypad.
4. Press **OK/START** to accept.
5. The oven will turn on when the delay start time (5:30) is reached.

Important note:

Delay Start may be set using a 24 hr clock. To set clock for 24 Hr operation, See "[Setting 12 Hour or 24 Hour display mode](#)" on [page 14](#) for more information. The Delay Start feature may be used with Convection Bake, Convection Roast, Convection Convert, Bake, Broil and Self Clean functions.

Bread Proof

The bread proof feature maintains a warm environment useful for rising yeast-leavened products. Bread Proof is available only in the lower oven. The following temperature settings apply to the bread proof feature:

- Bread proof setting: 100°F/38°C.

To set oven to Bread Proof:

1. Press Bread Proof.
2. **PrF** will appear in the display.
3. Press **OK/START** to accept.
4. The oven will maintain the proofing temperature. Use oven light to check on progress. Turn light off after checking.
5. When finished proofing press **OFF**.

SETTING OVEN CONTROLS

Setting Broil

Use the broil function to cook foods that require direct exposure to radiant heat for optimum browning results. Broiling may produce smoke. If smoke is excessive, place food further away from the element.

The broil feature preset to 550°F. Broil may be set at any temperature between 400°F (205°C) and 550°F (288°C).

! WARNING

Should an oven fire occur, leave the oven door closed and turn off the oven. If the fire continues, use a fire extinguisher. Do not put water or flour on the fire. Flour may be explosive and water can cause a grease fire to spread and cause personal injury.

! CAUTION

Always use pot holders or oven mitts when using the oven. When cooking, the oven interior, oven racks, and cooktop will become very hot which can cause burns.

Important: Broiler pans and inserts allow the grease to drain away from the high heat of the broiler. Do not use the pan without the insert. Do not cover the insert with foil – the exposed grease could ignite.

Note: OPEN DOOR BROIL SHUTOFF: If the oven door is left open during Broil for more than 3 minutes an alarm will sound to notify the user to close the oven door. If the door is not closed the oven will turn off within 30 seconds of the open door alarm.

To set broil with the default broil oven temperature of 550°F:

1. Arrange the oven racks when cool. For optimum browning results, preheat oven for 2 minutes before adding food. Broil can be set with Start Time.
2. Press **Broil**. Broil with oven door closed.
3. Position bakeware in oven.
4. Press **OK/START**. To adjust the broil temperature, press **Broil** again and then enter the new temperature using the number keys. Press **OK/START**.
5. Broil on one side until food is browned; turn on broil other side until done to your satisfaction.
6. When finished broiling, press **OFF**.

To cancel broil at any time, press **OFF**.

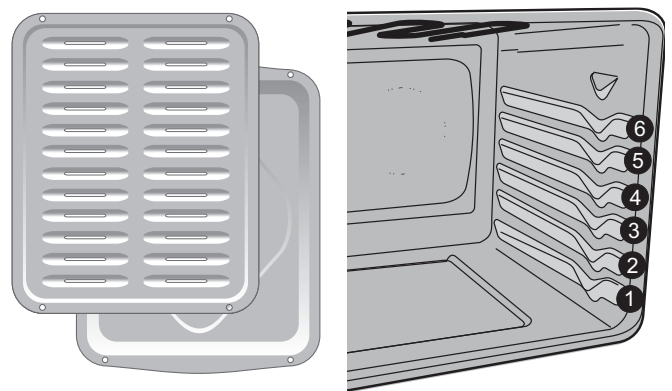

Figure 15: Broil pan with insert(L) Rack Positions (R)

Note: If a broiler pan and insert are not supplied with this appliance they may be purchased from frigidaire.com

SETTING OVEN CONTROLS

Important notes:

- Always arrange oven racks when the oven is cool.
- For best results when broiling, use a broil pan with broil pan insert designed to drain the fat from the food and help avoid spatter and reduce smoking.
- When broiling, always pull the oven rack out to the stop position before turning or removing food.
- If a broiler pan and insert are not supplied with this appliance they may be purchased from frigidaire.com.

Table 1: Broil Suggestions

Food	Rack Position	Temperature	Cook time (minutes)		Internal Temperature	Doneness
			1st side	2nd side		
Steak 1" thick	5th**	550°F (288°C)	5	4	140°F (60°C)	Rare*
Steak 1" thick	5th or 6th**	550°F (288°C)	6	4	145°F (63°C)	Medium
Steak 1" thick	5th or 6th**	550°F (288°C)	8	7	170°F (77°C)	Well
Pork Chops 3/4" thick	5th	550°F (288°C)	12	10	170°F (77°C)	Well
Chicken bone-in	5th	450°F (232°C)	20	10	170°F (77°C)	Well
Chicken boneless	5th	450°F (232°C)	8	6	170°F (77°C)	Well
Fish	5th	550°F (288°C)	as directed		170°F (77°C)	Well
Shrimp	4th	550°F (288°C)	as directed		170°F (77°C)	Well
Hamburger 1" thick	5th**	550°F (288°C)	9	7	145°F (63°C)	Medium
Hamburger 1" thick	5th	550°F (288°C)	10	8	170°F (77°C)	Well

* The U.S. Department of Agriculture states, "Rare fresh beef is popular, but you should know that cooking it to only 140°F (60°C) means some food poisoning organisms may survive." (Source: Safe Food Book, Your Kitchen Guide) The lowest temperature recommended by the USDA is 145°F (63°C) for medium rare fresh beef. For well done 170°F (77°C).

NOTE: Broiling is direct heat cooking and will produce some smoke. If smoke is excessive, place food further away from element. Always watch foods carefully to prevent burning.

SETTING OVEN CONTROLS

Convection Roast

Convection roast combines a cook cycle with the convection fan and element to rapidly roast meats and poultry. Heated air circulates around the meat from all sides, sealing in juices and flavors. Meats cooked with this feature are crispy and brown on the outside while staying moist inside. When convection roast is set there is no preheat tone and preheating is not necessary.

⚠ WARNING

Should an oven fire occur, close the oven door and turn the oven off. If the fire continues, use a fire extinguisher. Do not put water or flour on fire. Flour may be explosive.

⚠ CAUTION

Always use pot holders or oven mitts when using the oven. When cooking, the oven interior, oven racks, and cooktop will become very hot which can cause burns.

Benefits of Convection Roasting:

- Some foods cook up 25 to 30% faster, saving time and energy.
- No special pans or bakeware required.
- Preheating is not necessary for most meats and poultry.
- Be sure to carefully follow your recipe's temperature and time recommendations or refer to the convection roast chart for additional information.

To use convection roast at a temperature of 350°F (177°C):

1. Place the meat on the broiler pan and insert. Place meat (fat side up) on insert
2. Make sure the insert is securely seated on top of the broiler pan. Do not use the broiler pan without the insert.
3. Place prepared food on oven rack and slide into oven.
4. Close the door.
5. Press **Conv Roast**.
6. Press **OK/START**.
7. When cooking is completed or to cancel convection roast press **OFF**.

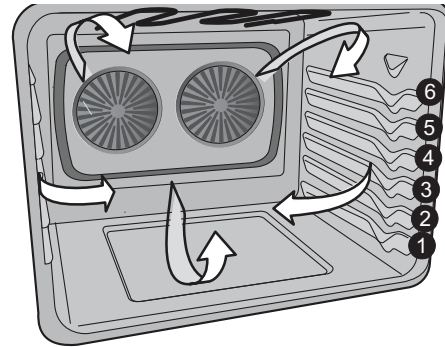

Figure 16: Convection roasting on lower oven racks

SETTING OVEN CONTROLS

Convection Roasting tips:

- Preheating for convection roast is not necessary for most meats and poultry.
- Arrange oven racks so large cuts of meat and poultry are on the lowest rack of the oven.
- Smaller roasts and poultry should be cooked using rack position 1 glide or 2 flat.
- Since convection roast cooks faster, may be able to reduce cook times as much as 25% from the recommended time of your recipe (check the food at this time). Then if needed, increase cook time until the desired doneness is obtained.
- Carefully follow your recipe's temperature and time recommendations or refer to the convection roast recommendations for additional information.
- Do not cover foods when dry roasting - covering will prevent the meat from browning properly.
- When cooking meats use the broiler pan and insert. The broiler pan will catch grease spills and the insert helps prevent grease splatters.
- It is not recommended to roast chicken on a roasting rack. Use a deep pan instead.

Table 2: Convection roasting temperature and time recommendations

Meat		Weight	Oven Temp	Internal Temp	Mins per lb.
Beef	Standing rib roast*	4 to 6 lb.	350°F (177°C)	*160°F (71°C)	25-30
	Rib eye roast*	4 to 6 lb.	350°F (177°C)	*160°F (71°C)	25-30
	Tenderloin roast	2 to 3 lb.	400°F (204°C)	*160°F (71°C)	15-25
Poultry	Turkey whole**	12 to 16 lb.	325°F (163°C)	180°F (82°C)	8-10
	Turkey whole**	16 to 20 lb.	325°F (163°C)	180°F (82°C)	10-15
	Turkey whole**	20 to 24 lb.	325°F (163°C)	180°F (82°C)	12-16
	Chicken	3 to 4 lb.	350°F-375°F (177°C-191°C)*	180°F (82°C)	12-16
Pork	Ham roast, fresh	4 to 6 lb.	325°F (163°C)	160°F (71°C)	30-40
	Shoulder blade roast	4 to 6 lb.	325°F (163°C)	160°F (71°C)	20-30
	Loin	3 to 4 lb.	325°F (163°C)	160°F (71°C)	20-25
	Pre-cooked ham	5 to 7 lb.	325°F (163°C)	160°F (71°C)	30-40

* The U.S. Department of Agriculture states, "Rare fresh beef is popular, but you should know that cooking it to only 140°F (60°C) means some food poisoning organisms may survive." (Source: Safe Food Book, Your Kitchen Guide) The lowest temperature recommended by the USDA is 145°F (63°C) for medium rare fresh beef. For well done 170°F (77°C)** Stuffed turkey requires additional roasting time. Shield legs and breast with foil to prevent over browning and drying of the skin.

SETTING OVEN CONTROLS

Cooking with Meat Probe

Use the meat probe feature for best results when cooking foods such as roasts, hams, or poultry.

The meat probe feature, when set correctly, will signal an alert when the internal food temperature reaches the desired set target temperature.

When active, the probe displays the internal food temperature which is visible in the display during the cooking process. This eliminates any guesswork or the need to open the oven door to check the thermometer.

For meats like poultry and roasts, using a probe to check internal temperature is the safest method to ensure properly cooked food.

CAUTION

Do not use kitchen utensils to pull on the probe cable or handles. Always insert and remove the meat probe using the provided handles, as shown in [Figure 17](#), and always use a pot holder to protect hands from possible burns.

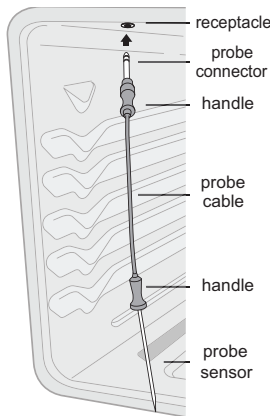

Figure 17: Using the meat probe

IMPORTANT

Do not store the meat probe inside the oven. Use only the original probe provided. Connecting any other probe or device could result in damage to the oven control, electronics, and the receptacle.

Before starting self clean, double check that the meat probe is removed from the oven interior. Defrost frozen foods completely before inserting the meat probe.

Proper placement of meat probe in food.

Insert the meat probe so that the probe tip rests inside the center of the thickest part of meat or food (See [Figure 18](#)). For best results, do not allow the probe temperature sensor to contact bone, fat, gristle, or the cookware.

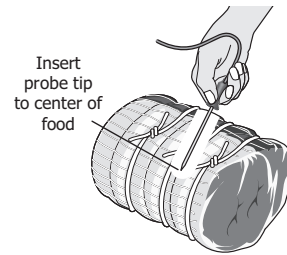

Figure 18: Probe in thickest area of food

- For bone-in ham or lamb, insert the meat probe into the center of lowest large muscle or joint.
- For meat loaf or casseroles, insert the meat probe into center of food.
- When cooking fish, insert meat probe just above the gill.
- For whole poultry or turkey, fully insert the probe sensor into the thickest part of the breast (See [Figure 19](#)).

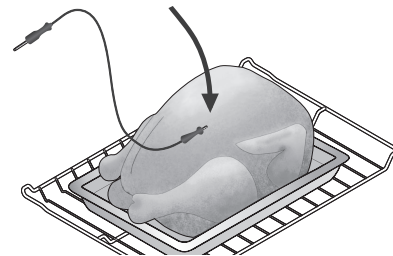

Figure 19: Probe in thickest part of breast

SETTING OVEN CONTROLS

To set meat probe:

1. Insert the meat probe into the food. Place prepared food on the desired oven rack position and slide into the oven.
2. Plug the connector end of the probe all the way into the probe receptacle while the oven is still cool. The receptacle is located on the upper left front oven cavity wall (See Figure 17). Close oven door.
3. Set for **Quick Preheat, Bake, Convection Bake, or Convection Roast** and if necessary adjust the oven temperature accordingly.
4. Press **OK/START**.
5. Press **Meat Probe**. The Meat Probe default temperature of 170°F appears. Using the numeric keys set the desired internal food temperature for food type. (See Figure 20).
6. Press **OK/START** to accept the target temperature.



Figure 20: Probe set showing meat probe temperature

Note: The minimum setting is 140°F (60°C); the maximum is 210°F (99°C). Default is 170°F (77°C).

7. The control will provide three beeps when the internal target temperature is reached.
8. When the internal target temperature is reached, the oven will automatically change to **Hid** setting and will maintain the oven temperature at 170°F (77°C) until canceled.
9. To stop cooking at any time, press **OFF**.

NOTE

During cooking the internal food temperature will display by default. To see the target temperature press the meat probe key once. After 6 seconds the display will revert to the internal food temperature. To assure accuracy, do not remove the probe from the food or receptacle until the desired internal temperature is reached.

If the probe is removed from the receptacle only, the probe feature will cancel but the oven will continue to cook. If the probe is removed from the food only, the probe feature will remain active and may eventually generate a probe too hot message.

To change the target temperature while cooking, press the meat probe key once. Use the numeric keys to change the temperature. Press the **OK/START** key to accept any change.

Table 3: USDA recommended minimum internal cooking temperatures

Food Type	Internal Temp.
Ground meat and meat mixtures	
Beef, Pork, Veal, Lamb	160°F (71°C)
Turkey, Chicken	165°F (74°C)
Fresh beef, veal, lamb	
Medium rare +	145°F (63°C)
Medium	160°F (71°C)
Well Done	170°F (77°C)
Chicken and Turkey, whole	165°F (74°C)
Poultry Breasts, Roasts	165°F (74°C)
Poultry Thighs, Wings	165°F (74°C)
Stuffing (cooked alone or in bird)	165°F (74°C)
Ham Fresh (raw)	160°F (71°C)
Ham Pre-cooked (to reheat)	140°F (60°C)
Eggs dishes	160°F (71°C)
Leftovers and Casseroles	165°F (74°C)

The U.S. Department of Agriculture states, "Rare fresh beef is popular, but you should know that cooking it to only 140°F (60°C) means some food poisoning organisms may survive." (Source: *Safe Food Book, Your Kitchen Guide*, USDA) Visit the USDA Food Safety and Inspection website at www.fsis.usda.gov

SETTING OVEN CONTROLS

To set how the oven will operate once the probe reaches the target temperature:

The oven is preset to automatically stop cooking and start the warm feature when probe sensor reaches the target temperature. This may be set to continue cooking if desired. Setting the options must be done when the oven is inactive. The probe is not required to be connected to the probe receptacle when setting this option.

To set the oven to continue cooking after reaching the target temperature:

1. Press **probe** key and hold for 6 seconds.
2. Press **Self Clean** key and toggle until **Continu** appears, (Figure 21) then press **OK/START** to accept.



Figure 21: Probe set to continue cooking

To set the oven to automatically stop cooking and start warm once reaching target temperature:

1. Press **probe** key and hold for 6 seconds.
2. Press the **Self Clean** key and toggle until **CAnCEL** appears (Figure 22), then press **OK/START** to accept.



Figure 22: Probe set to cancel cooking

Probe too hot message:

When the message **Prob... Too... Hot...** flashes in the display, the probe temperature has exceeded 250°F (121°C). If the probe is not removed, this message may continue until the sensor reaches 300°F (149°C) or higher, and oven will automatically turn off. Be sure the probe sensor is fully covered by the food.

Warm

Warm should only be used with foods that are fully cooked and at serving temperatures. Warm will keep foods warm and ready for serving at 170° F (77°C) until canceled.

To set Warm:

1. If needed, arrange oven racks and place cooked food in oven.
2. Press **Warm**: **WARM** will appear in the display. (If no other keys are touched within 25 seconds the request for Warm will clear.)
3. Press **OK/START**. **Warm** will automatically turn on and remain on until cancelled.

Note: To turn Warm off at any time, press **OFF**.

WARNING

Food poisoning hazard. Do not let food sit for more than one hour before or after cooking. Doing so can result in food poisoning or sickness.

Note: When using the Meat Probe for cooking, the Warm function will turn on automatically once the probe reaches the target temperature of the food and remain on at a serving temperature of 170°F until canceled.

SETTING OVEN CONTROLS

Setting the Sabbath Feature (for use on the Jewish Sabbath and Holidays)



For further assistance, guidelines for proper usage, and a complete list of models with the Sabbath feature, please visit the web at www.star-k.org.

This appliance provides special settings for use when observing the Jewish Sabbath/Holidays. Sabbath mode disables all audible tones or visual display changes on the oven control. **Bake** is the only cooking feature available while in the Sabbath mode. Oven controls are locked during Sabbath mode.

You must first set the Bake feature and temperature(s) needed for the oven and Delay Start options (if needed). Any settings made prior to setting the Sabbath mode will be visible in the displays.

The Sabbath mode will override the factory preset 12 hour energy saving mode, and the appliance will stay on until the cooking features are canceled. If any of the cooking features are canceled when the appliance is in the Sabbath mode, no audible or visual indicators will be available to verify the cancellation.

If the oven interior lights are needed, be sure to activate them prior to setting the Sabbath mode. Once the oven light is turned on and the Sabbath mode is active, the oven light will remain on until the Sabbath mode is turned off and the oven lights are turned off. The oven door will not activate the interior oven lights when the oven door is opened or closed.

It is recommended that any oven temperature modification made within an active Sabbath mode be followed with two presses of the **OK/START** key. This will insure the oven remains on even if an attempt is made to set the oven temperature outside of its temperature range.

If the oven temperature is set outside of the temperature range, the oven will default to the nearest available temperature. Try to set the desired oven temperature again.

WARNING

Food poisoning hazard. Do not let food sit for more than one hour before or after cooking. Doing so can result in food poisoning or sickness. Foods that can easily spoil such as milk, eggs, fish, meat or poultry, should be chilled in the refrigerator first. Even when chilled, they should not stand in the oven for more than 1 hour before cooking begins, and should be removed promptly when finished cooking.

Important:

- Do not attempt to activate any other oven function except Bake while the Sabbath feature is active. The following keys will function correctly when the Sabbath feature is active: 0-9 number keypad, Bake, OK/START, and OFF. All other keys should not be used once the Sabbath feature is active.
- You may change the oven temperature once baking has started. Press **Bake**, use the numeric keypad to enter the oven temperature change (170°F to 550°F), and press **OK/START** (for Jewish Holidays only).
- Remember that the oven control will no longer provide audible tones or display any further changes when the Sabbath feature is active.
- The oven will remain on until canceled and therefore may only be used once during the Sabbath/Jewish Holidays.
- If a delay start time longer than 11 hours and 59 minutes is desired, set the oven control for the 24 hour day display mode setting. See [“Setting 12 Hour or 24 Hour display mode”](#) on [page 14](#) for more information.

SETTING OVEN CONTROLS

To program oven to Bake with default oven temperature of 350°F and activate the Sabbath feature:

1. Be sure the clock is set with the correct time of day.
2. Arrange oven racks, place bakeware in oven, and close oven door. Press **Bake**.
3. Note: If Delay Start is desired enter the time at this point. See “Setting Delay Start” on page 19 for detailed instructions.
4. Press **OK/START**.
5. Press and hold **Self Clean** and **Delay Start** simultaneously for about 3 seconds to set the Sabbath feature. Once the feature is set, **SAb** will appear in the display indicating the oven is properly set for the Sabbath feature (Figure 23).



Figure 23: Oven set for Sabbath baking

To turn the oven off and keep the Sabbath feature active:

1. Press **OFF**.

To turn off the Sabbath feature:

Press and hold both **Self Clean** and **Delay Start** simultaneously for at least 3 seconds to turn the Sabbath feature off. The control will provide an acceptance tone, and **SAb** will disappear from the display. The oven is no longer programmed for the Sabbath feature.

What to do during a power failure or power interruption after the Sabbath feature was activated:

Should you experience a power failure or interruption, the oven will shut-off. When power is restored the oven will not turn back on automatically. The oven will remember that it is set for the Sabbath, and the oven display will show the message **SF** for Sabbath failure (Figure 24).



Figure 24: Display showing Sabbath failure

The food may be safely removed from the oven while still in the Sabbath feature, however the oven cannot be turned back on until after the Sabbath/Holidays. After the Sabbath observance turn off the Sabbath feature.

Press and hold both **Self Clean** and **Delay Start** keys for at least 3 seconds simultaneously to turn the Sabbath feature off. **SF** will disappear from the display, and the oven may be used with all normal functions.

SETTING OVEN CONTROLS

Restoring Factory Default Settings

Your appliance was set with predetermined (default) oven control settings. Over time, users may have made changes to these settings. The following options may have been modified since the appliance was new:

- 12 or 24 hr display mode
- All Meat Probe settings
- Continuous bake or 12 hour energy savings mode
- Silent or audible control
- Oven temperature display (Fahrenheit or Celsius)
- Oven temperature adjustments (UPO)

CAUTION

All of the above user settings will be restored to the factory default settings.

To restore oven control to factory default settings:

1. Press and hold **7** on numeric keypad until acceptance tone sounds (about 6 seconds).
2. Press **OK/START**. The control has been reset with the default settings.

Adjusting Oven Temperatures

Your appliance has been factory calibrated and tested to ensure accurate baking temperatures. For the first few uses, follow your recipe times and temperature recommendations carefully. If you think the oven is cooking too hot or too cool for your recipe times, you may adjust the control so the oven cooks hotter or cooler than the oven temperature displayed.

Important: Do not use oven thermometers such as those found in grocery stores to check the temperature settings inside your oven. These oven thermometers may vary as much as 20 to 40°F degrees from actual temperatures.

The oven temperature may be increased as much as +35°F (+19°C) or decreased -35°F (-19°C) from the factory calibrated settings.

To increase or decrease the oven temperature by 20°F:

1. Press and hold **Bake** until the control produces an audible tone (about 6 seconds). The factory offset temperature of 0 (zero) should appear in the display.
2. Enter **2 0** using numeric keypad.
3. To offset the oven by -20°F, press **self clean** to toggle between + and -.
4. Press **OK/START** to accept change.

Important note:

- Oven temperature adjustments will not change the Broil, Self Clean, or Keep Warm temperatures.
- The oven temperature adjustment may be made if your oven control is set to display temperatures in °C (Celsius). Minimum and maximum settings for Celsius range from plus (+)19°C to minus (-) 19°C.

SETTING OVEN CONTROLS

Self Clean

A self cleaning oven cleans itself with high temperatures (well above normal cooking temperatures), which eliminate soils completely or reduces them to a fine powdered ash you can wipe away with a damp cloth. Self Clean can be programmed for clean times between 2 and 4 hours.

Important: Before starting self clean read all following caution and important statements before starting a self clean cycle

CAUTION

- Do not leave small children unattended near appliance. During self clean cycle, the outside of the oven can become very hot and cause burns if touched.
- Do not line the oven walls, racks, oven bottom, or any part of the range with aluminum foil. This will cause permanent damage to the oven interior and destroy heat distribution, and will melt to the oven interior.
- Do not force the oven door open. This will damage the automatic door locking system. Use caution when opening the oven door after the self clean cycle ends. The oven may still be very hot and cause burns. To avoid possible burns, stand to side of oven when opening door to allow steam or hot air to escape.
- The health of some birds is extremely sensitive to fumes given off during the self clean cycle of any range. Move birds to a well ventilated room.

Important notes:

- Completely remove all oven racks and any accessories from oven cavity to avoid damage to oven racks. If the oven racks are not removed they may discolor.
- Remove all items from the oven and cooktop including cookware, utensils, and any aluminum foil. Aluminum foil will not withstand high temperatures from a self clean cycle and will melt.
- Do not spray oven cleaners or oven protective coatings in or around any part of the oven interior. Clean any soil from the oven frame, the door liner outside the oven door gasket, and the small area at the front center of the oven bottom (Figure 25). These areas heat sufficiently to burn soil on. Clean using soap and water prior to starting Self Clean.

- Remove any excessive spills. Any spills on the oven bottom should be wiped up and removed before starting a self clean cycle. To clean use hot, soapy water and a cloth. Large spills can cause heavy smoke or fire when subjected to high temperatures.
- Do not allow food spills with high sugar or acid content (such as milk, tomatoes, sauerkraut, fruit juices, or pie fillings) to remain on the surface as they may leave a dull spot even after cleaning.
- Do not clean the oven door gasket. The woven material in the gasket is essential for a good seal. Care should be taken not to rub, damage, or remove the oven door gasket. Doing so could cause damage to the door gasket and compromise the performance of the oven.

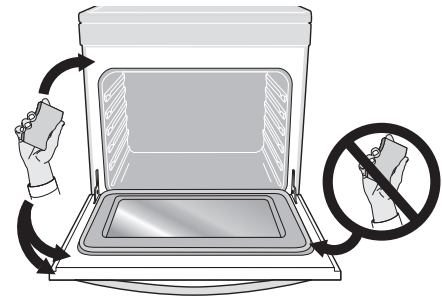

Figure 25: Areas to clean and areas to avoid (gasket)

- The kitchen area should be well ventilated using an open window, ventilation fan, or exhaust hood during the first self clean cycle. This will help eliminate the normal odors.
- Do not attempt to open the oven door when the OVEN LOCK indicator light is flashing. Allow about 15 seconds for the motorized door latch mechanism to completely lock or unlock the oven door.
- When the clean time finishes, the oven door will remain locked until the range has cooled sufficiently. In addition to the clean time that was programmed, you must allow about 1 additional hour for the oven to cool before you will be able to open the oven door.

SETTING OVEN CONTROLS

Setting Self Clean

To set self clean:

1. Be sure the oven is empty and all oven racks are removed. Remove all items from the oven. Be sure oven door is completely closed.
2. Press **Self Clean**.
3. A 3 hour clean time will appear in the display. You may accept the 3 hour clean time or choose a different clean duration by entering any time between 2 and 4 hours clean time by entering the time using the numeric keys.
4. Press **OK/START** twice to activate self clean.
5. The warning to **REMOVE RACKS** will flash in the display and beep for 30 seconds to remind you that oven racks should be removed before a self clean.
6. The warning will end and Self Clean will start. The motor door lock will begin locking the oven door.

When the oven is set to run a self-clean cycle, the motor door lock will begin locking the oven door. Do not open the oven door while the lock motor is running or when any locking indicators or displays are showing. The oven door is completely locked in about 15 seconds. Once the oven door has locked, **CLEAN** will appear in the display indicating self clean has started.

Do not force the oven door open when self-clean is active. This can damage the automatic door-locking system. Use caution when opening the door after self-clean cycle is complete; the oven may still be very hot.

When self clean is finished:

1. **CLEAN** message will turn off, and **Hot** will appear in display window.
2. Once the oven has cooled down (about 1 hour) and **Hot** is no longer displayed, the oven door may be opened.
3. When the oven interior has completely cooled, wipe away any residue or powdered ash with a damp cloth or paper towel.

Setting Delay Start Self Clean

To start a delay self clean with default clean time of 3 hours and a start time of 9:00 o'clock:

1. Be sure the clock is set with the correct time of day, the oven is empty, and all oven racks are removed. Be sure oven door is completely closed.
2. Press **Self Clean**
3. Press **Delay Start**.
4. Using numeric keypad, enter **9 0 0**.
5. Press **OK/START** twice to accept.

If it becomes necessary to stop self clean when active:

1. Press **OFF**.
2. If self clean has heated the oven to a high temperature, allow enough time for the oven to cool.
3. Before restarting self clean, be sure to read important notes below.

Important note:

- If your clock is set with the (default) 12 hr display mode, the delay start for a self clean can only be programmed to start up to 11 hours and 59 minutes after the time showing in the display (be sure to set the clock to current time before programming a Delay Start). To set a Delay Start self clean to begin 12 or more hours (maximum is 23 hours and 59 minutes) after the time of setting, be sure to first set the control in the 24 Hr display mode.
- If self clean was active and then interrupted by a power failure or cancelled before the oven was thoroughly cleaned, it may be necessary to run another self clean cycle.
- If the oven temperature was high enough when self clean was interrupted the oven control may not allow another self clean cycle to be set for up to 4 hours.

CAUTION

To avoid possible burns, use care when opening the oven door after the self-cleaning cycle. Stand to the side of the oven when opening the door to allow hot steam and air to escape.

SETTING OVEN CONTROLS

Steam Clean

The Steam Clean feature offers a chemical free and time saving method to assist in the routine cleaning of small and light soils. For heavier baked on soils use the Self Clean feature.

CAUTION

Do not add bleach, ammonia, oven cleaner, or any other abrasive household cleaners to the water used for Steam Clean. Before cleaning any part of the oven, be sure all controls are turned off and the oven is cool. The oven may be hot and can cause burns.

Be sure the oven is level and cool before starting Steam Clean. If the oven temperature is above room temperature a triple beep will be heard and the function will not start. Steam Clean produces best results when started with a cool oven.

To set a Steam Clean cycle:

1. Remove all racks and oven accessories.
2. Scrape or wipe loose debris and grease from the oven bottom.
3. Pour 1 cup of tap water onto the oven bottom. (Figure 26) Close oven door.

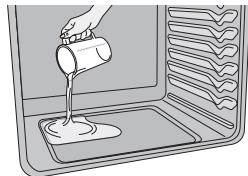

Figure 26: Add 1 cup of tap water

4. Press **Steam Clean**.
5. Press **OK/START**. **St C** will appear in the display.
6. To see time remaining in the Steam Clean cycle press **Steam Clean** key. The time left will show in the display for 6 seconds before returning to the time of day. Do not open the door during this time. If door is opened during Steam Clean for more than 4 minutes, **d-O** will appear in the display and the display will sound a triple beep until the door is closed.
7. When the steam clean cycle is complete an alert will sound and the **END** message will show in the display. Press off to return to the clock.

8. Take care opening the door when the steam clean is finished. Stand to the side of the oven out of the way of escaping vapor.
9. Wipe oven cavity and bottom. Do not clean oven door gasket (Figure 27). Avoid leaning or resting on the oven door glass while cleaning cavity.
10. To cancel Steam Clean at any time press **OFF**.

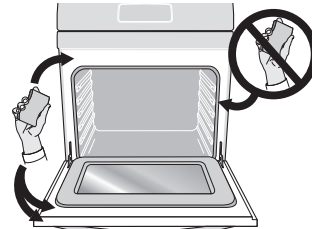

Figure 27: Clean around the oven door gasket

Important: Opening oven door during Steam Clean cycle prevents the water from reaching the temperature needed to clean. If the door is left open once Steam Clean starts, an alarm will sound alerting you to close the door.

- Opening oven door during Steam Clean cycle prevents the water from reaching the temperature needed to clean.
- For best results, clean oven immediately after the cycle is complete. Steam clean works best for soils on the oven bottom.
- Place a paper towel or cloth in front of the oven to capture any water that may spill while wiping out.
- A non abrasive scouring pad, stainless steel sponge, plastic scraper, or eraser style cleaning pad (without cleaner) can be used for difficult soils. Moisten pads with water before use.
- Do not leave the residual water in the oven for any length of time.
- Some condensation or water vapor may appear close to the oven vent. This is normal. The oven gasket may become damp; do not wipe dry.
- Local water sources often contain minerals (hard water). If hard water deposits occur, wipe cavity with a 50/50 solution of water and vinegar or 50/50 solution of lemon juice and water.
- Steam clean cannot be programmed with a delay start.
- If Steam Clean results are not satisfactory, run a Self Clean. See "[Self Clean](#)" on [page 30](#).

CARE AND CLEANING

Remove spills and any heavy soiling as soon as possible. Regular cleaning will reduce the difficulty of major cleaning later.

CAUTION

- Before cleaning any part of the appliance, be sure all controls are turned off and the appliance is cool.
- If ammonia or appliance cleaners are used, they must be removed and the appliance must be thoroughly rinsed before operating. Follow manufacturer's instructions and provide adequate ventilation.

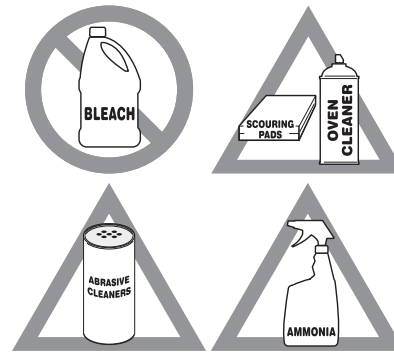

Surface Type	Recommendation
Aluminum and Vinyl trim Painted body parts Painted decorative trims Plastic	Use hot, soapy water and dry with a clean cloth. Use a soft cloth and clean with mild dish detergent and water or a 50/50 solution of vinegar and water. Follow by rinsing the area with clean water; dry and polish with a soft cloth. Glass cleaners may be used if sprayed on a soft cloth first. Do not spray liquids directly on the oven control and display area. Do not use large amounts of water on the control panel. Excess water on the control area may cause damage to the appliance. Do not use other liquid cleaners, abrasive cleaners, scouring pads, or paper towels. They will damage the finish.
Control Pad Decorative trim (some models)	Use a soft cloth and clean with mild dish detergent and water or a 50/50 solution of vinegar and water. Follow by rinsing the area with clean water; dry and polish with a soft cloth. Glass cleaners may be used if sprayed on a soft cloth first. Do not spray liquids directly on the oven control and display area. Do not use large amounts of water on the control panel. Excess water on the control area may cause damage to the appliance. Do not use other liquid cleaners, abrasive cleaners, scouring pads, or paper towels. They will damage the finish.
Stainless steel (some models)	Only use cleaners and polishes specifically manufactured for cleaning stainless steel. Always rub in direction of metal grain to avoid damaging. Do not use cleaners with high concentrations of chlorides or chlorine. Do not use harsh scrubbing cleaners. Polish with a lint-free cloth. Be sure to wipe excess cleaner/polish off from the metal surface as bluish stains may occur during future oven heating that cannot be removed. Clean heavier soils with hot, soapy water and a cloth or sponge. Use clean water to rinse; use a cloth to dry.
Smudge-Proof™ Stainless Steel (some models)	Clean the stainless with warm soapy water using a clean sponge or cloth. Rinse with clean water and dry with a soft clean cloth. Do not use store bought cleaners like stainless steel cleaners or any other types of cleaners containing any abrasive, chlorides, chlorine, or ammonia. Use mild dish soap and water or a 50/50 solution of water and vinegar.
Porcelain enamel broiler pan and insert (available by mail order) Door liner and body parts	Gentle scouring with a soapy scouring pad will remove most spots. Rinse with a 1:1 solution of clear water and ammonia. If necessary, cover difficult spots with an ammonia soaked paper towel for 30 to 40 minutes. Rinse with clean water and a damp cloth, then scrub with a soap-filled scouring pad. Rinse and wipe dry with a clean cloth. Remove all cleaners or the porcelain may become damaged during future heating.
Oven interior	Remove oven racks from the oven cavity before cleaning the oven interior. Use a mild, abrasive cleaner following manufacturer's instructions. Rinse with clean water and dry.
Oven racks	Oven racks must be removed before a self clean. Clean by using a mild, abrasive cleaner following manufacturer's instructions. Rinse with clean water and dry.
Oven door	Use soap and water to thoroughly clean the top, sides, and front of the oven door. Rinse well. Only use a glass cleaner on the outside glass of the door. Do not immerse the door in water. Do not spray or allow water or the glass cleaner to enter the door vents. Do not use oven cleaners, powders, or any harsh abrasive cleaning materials on the outside of the oven door. Do not clean the oven door gasket which is essential for a good seal. Do not rub, damage, or remove this gasket.

CARE AND CLEANING

General Cleaning

Refer to the table at the beginning of this chapter for more information about cleaning specific parts of the oven.

CAUTION

Before manually cleaning any part of the oven, be sure all controls are turned off and the oven is cool. The oven may be hot and can cause burns.

Remove all racks and accessories from the oven before cleaning.

Ammonia must be rinsed before operating the oven. Provide adequate ventilation.

Follow these cleaning precautions:

- Allow the oven to cool before cleaning.
- Wear rubber gloves when cleaning the appliance manually.

Remove soils using hot, soapy water. Do not allow food spills with a high sugar or acid content (such as milk, tomatoes, sauerkraut, fruit juices or pie filling) to remain on the surface as they may cause a dull spot even after cleaning. Remove spillovers and heavy soiling as soon as possible. Regular cleaning will reduce the effort required for major cleaning later.

Cleaning Porcelain Enamel Oven

The oven interior is porcelain on steel, it is safe to clean using oven cleaners.

To remove heavy soil:

1. Allow a dish of ammonia to sit in the oven overnight or for several hours with the oven door closed. Clean softened dirt spots using hot, soapy water. Rinse well with water and a clean cloth.
2. If soil remains, use a nonabrasive scouring pad or a nonabrasive cleaner. If necessary, use an oven cleaner following manufacturer's instructions. Do not mix ammonia with other cleaners.
3. Clean any soil from the oven frame, the door liner outside the oven door gasket and the small area at the front center of the oven bottom. Clean with hot, soapy water. Rinse well using clean water and a cloth.

Broiler Pan Cleaning Tips

To prevent grease from baking on, remove the broiler pan from the oven as soon as cooking is completed. Use oven mitts because the broiler pan is extremely hot. Pour off grease. Soak the pan in hot, soapy water.

Clean the broiler pan as soon as possible after each use. If necessary, use soap-filled steel wool pads. Heavy scouring may scratch the grid.

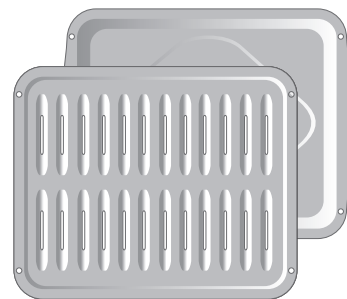

Figure 28: Broiler pan with insert

CARE AND CLEANING

Aluminum Foil, Aluminum Utensils, and Oven Liners

⚠ WARNING

Never cover any slots, holes, or passages in the oven bottom or cover an entire oven rack with materials such as aluminum foil. Doing so blocks air flow through the oven and may cause carbon monoxide poisoning. Aluminum foil linings may trap heat, causing a fire hazard.

- Protective liners—Do not use aluminum foil to line the oven bottom. The high heat of the oven can melt these materials to the oven cavity and ruin the oven. These types of materials can also reduce the effectiveness of the air circulation in the oven and produce poor baking results. Only use aluminum foil as recommended in this manual. Improper installation of these liners may result in risk of electric shock or fire.
- Aluminum utensils - The melting point of aluminum is much lower than that of other metals. Care must be taken when aluminum pots or pans are used.
- Oven racks - Do not use aluminum foil to cover the oven racks. Using a liner in the oven restricts the heat and air flow needed to obtain the best possible cooking results for any oven.

Adhere to the following precautions when using spray oven cleaners:

- Do not spray cleaner on the electrical controls or switches because it could cause a short circuit and result in sparking or fire.
- Do not spray any cleaner on the oven door trim or gasket, broiler drawer glides, handles or any exterior surfaces of the oven, plastic or painted surfaces. The cleaner can damage these surfaces.
- Do not allow a film from the cleaner to build up on the temperature sensing bulb; it could cause the oven to heat improperly. The bulb is located in the rear of the oven. Carefully wipe the bulb clean after each oven cleaning, being careful not to move the bulb. A change in its position could affect how the oven bakes. Avoid bending the bulb and capillary tube.

Replacing the Oven Light

⚠ CAUTION

Be sure the oven is unplugged and all parts are cool before replacing the oven light.

The interior oven light is located at the rear of the oven cavity and is covered by a glass shield. The glass shield must be in place whenever the oven is in use (Figure 29).

To replace the oven interior light bulb:

1. Turn electrical power off at the main source or unplug the appliance.
2. Remove interior oven light shield by turning a quarter turn counter-clockwise.
3. Replace bulb with a new T-4 type Halogen 25 watt appliance bulb.

📌 NOTE

Wear a cotton glove or use a paper towel when installing a new bulb. Do not touch the new bulb with your fingers when replacing. This will shorten the life of the bulb.

4. Replace glass oven light shield by rotating clockwise.
5. Turn power back on again at the main source (or plug the appliance back in).
6. Be sure to reset the time of day on the clock

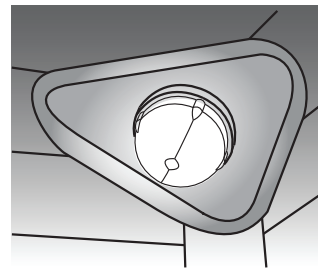

Figure 29: Wall oven Halogen light

CARE AND CLEANING

Caring for Your Glide Racks

Caution: Handle oven racks only when they are cool. After cooking or after the fresh-clean cycle, racks will be very hot and can cause burns.

Important Notes:

- Remove all oven racks, including ladder racks, before starting a clean cycle.
- Do not use cooking oil, cooking spray, or other oil-based lubrication products on the glide rack extension tracks. Use only the graphite lubrication in this area. To order graphite lubrication, contact your installer, servicer or dealer.
- It is important that the parts of the rack that contact the oven sides always have a light coating of vegetable oil. Apply a thin layer of vegetable oil to the sides of the rack after every fresh-clean cycle and when the rack becomes difficult to reposition in the oven.

To lubricate the glide rack:

1. Remove the rack from the oven and place the rack on a large flat surface covered with newspaper or scrap cloth. Fully extend the rack.
2. Wipe away debris and crumbs from the glide track using a cloth or sponge.

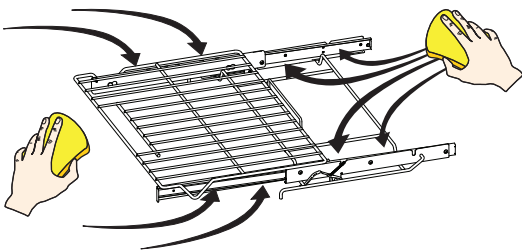

3. Shake graphite lubrication very well before applying. Apply to loading guides, and rotation pin. Repeat on both sides of the glide rack.

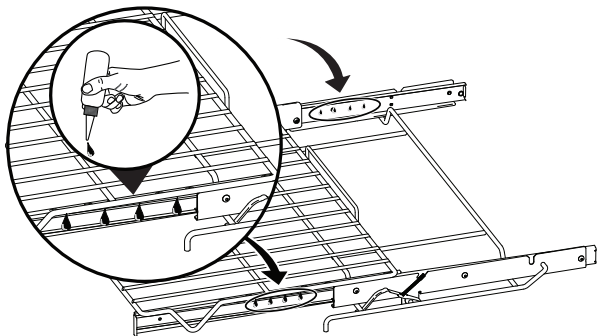

4. Extend and return the glide rack several times along the tracks to distribute the lubrication.

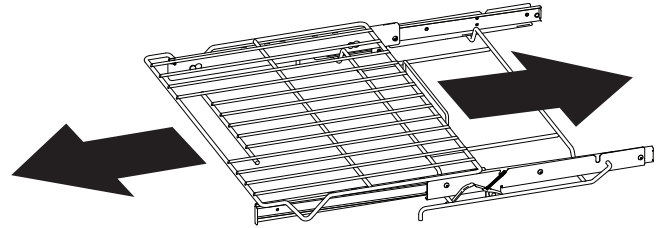

5. Turn the rack upside down and apply graphite lubrication to the insides of the loading guides.

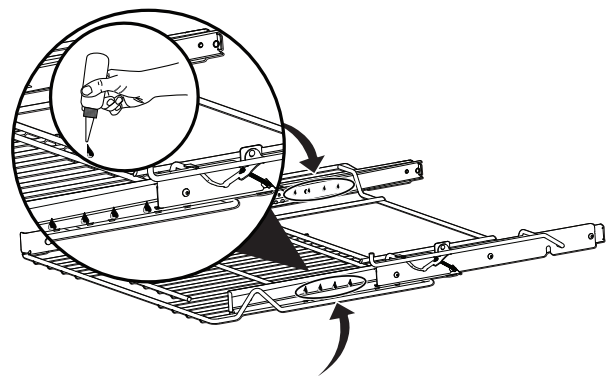

6. Extend and return the glide rack several times along the tracks to distribute the lubrication.
7. Apply a thin layer of cooking oil to the bottom of the "V" and the glide channels. Keeping the frame sides lightly lubricated allows the entire rack to slide easily when changing rack positions.

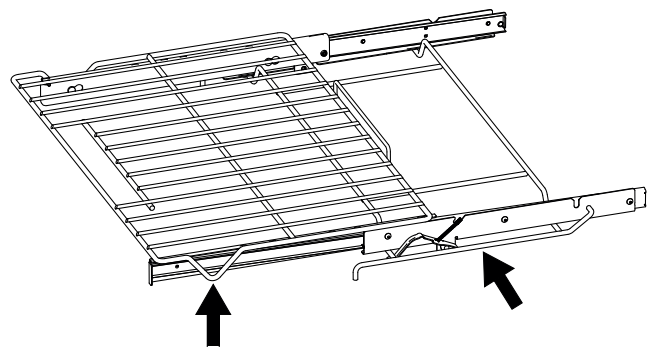

8. Replace rack in oven right-side up.

Removing and Replacing the Oven Door

→ IMPORTANT

Special door care instructions - The door is heavy. For safe, temporary storage, lay the door flat with the inside of the door facing down.

Most oven doors contain glass that can break. Do not close the oven door until all the oven racks are positioned correctly in the cavity. Do not hit the glass with bakeware or any other objects. Scratching, hitting, jarring, or stressing the glass may weaken its structure, causing an increased risk of breakage at a later time.

To remove the oven door:

1. Open oven door completely, horizontal with floor.
2. Pull up the lock located on each hinge support toward front of the oven until the lock stops. You may have to apply a little upward pressure on the lock to pull it up (Figure 31 and Figure 32).
3. Grasp the door by the sides, and close the door until the door frame makes contact with the unlocked hinges.
4. Pull the bottom of the door toward you while rotating the top of the door toward the appliance to completely disengage the hinge levers (Figure 33).

To Replace Oven Door:

1. Firmly grasp both sides of oven door along the door sides. Do not use the oven door handle (Figure 33).
2. Hold the oven door at the same angle as the removal position. Carefully insert the hinge levers into the oven frame until you feel the hinge levers are seated into the hinge notches. The hinge arms must be fully seated into the hinge notches before the oven door can be fully opened. (Figure 33).
3. Fully open the oven door, horizontal with floor (Figure 30).
4. Push the door hinge locks up toward and into the oven frame on both left and right oven door hinges to the locked position (Figure 31).
5. Close the oven door.

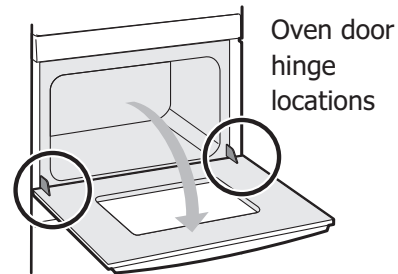

Figure 30: Door hinge location

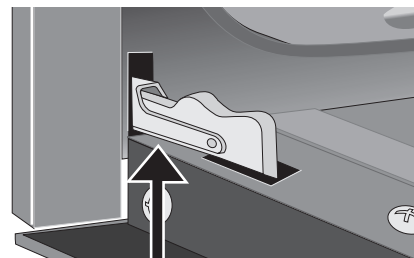

Figure 31: Door hinge locked

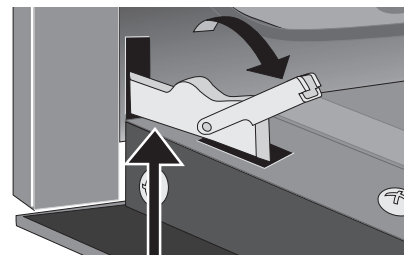

Figure 32: Unlocking door hinge

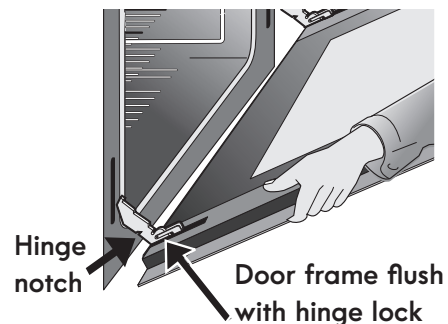

Figure 33: Remove door position

BEFORE YOU CALL





Solutions to Common Baking Problems

For best cooking results, fully preheat the oven before baking cookies, breads, cakes, pies or pastries, etc.

There is no need to preheat the oven for roasting meat or baking casseroles.

The cooking times and temperatures needed to bake a product may vary slightly from your previously owned appliance.

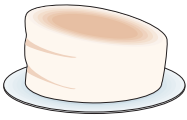
Baking Problems and Solutions Chart

Baking Problems	Causes	Corrections
Cookies and biscuits burn on the bottom. 	<ul style="list-style-type: none"> • Cookies and biscuits put into oven before the preheating time is completed. • Oven rack is overcrowded. • Dark pans absorb heat too fast. 	<ul style="list-style-type: none"> • Allow oven to preheat to desired temperature before placing food in oven, • Choose pan sizes that will permit 2 to 4 inches (5.1 to 10.2 cm) space on all sides when placed in the oven. • Use a medium weight baking sheet.
Cakes too dark on top or bottom. 	<ul style="list-style-type: none"> • Cakes put in oven before preheating time is completed. • Rack position too high or too low. • Oven too hot. 	<ul style="list-style-type: none"> • Allow oven to preheat to the selected temperature before placing food in the oven. • Use proper rack position for baking needs. • Set oven temperature 25°F (13°C) lower than recommended.
Cakes not done in center. 	<ul style="list-style-type: none"> • Oven too hot. • Incorrect pan size. • Pan not centered in oven. 	<ul style="list-style-type: none"> • Set oven temperature 25°F (13°C) lower than recommended. • Use pan size suggested in recipe. • Use proper rack position and place pan to allow for 2 to 4 inches (5.1 cm to 10.2 cm) space on all sides of pan.
Cakes not level. 	<ul style="list-style-type: none"> • Oven not level. • Pan too close to oven wall or rack overcrowded. • Pan warped. • Oven light left on while baking. 	<ul style="list-style-type: none"> • Place a marked glass measuring cup filled with water on the center of the oven rack. If the water level is uneven, refer to the installation instructions for leveling the oven. • Be sure to allow 2" to 4" (5.1 cm to 10.2 cm) of clearance on all sides of each pan in the oven. • Do not use pans that are dented or warped. • Leave oven light off while baking.
Foods not done when cooking time is over. 	<ul style="list-style-type: none"> • Oven too cool. • Oven overcrowded. • Oven door opened too frequently. 	<ul style="list-style-type: none"> • Set oven temperature 25°F (13°C) higher than suggested and bake for the recommended time. • Be sure to remove all pans from the oven except the ones to be used for baking. • Open oven door only after shortest recommended baking time.

Solutions to Common Problems

Before you call for service, review the following list. It may save you time and expense.

Possible solutions are provided with the problem listed:

Problem	Solution
Oven control panel beeps and displays error codes	<ul style="list-style-type: none"> Oven control has detected a fault or error condition. When this occurs an E or F will show in the display. Press OFF: Activate a Bake or Broil. If the F or E code error repeats, turn off power to appliance, wait 5 minutes and then repower appliance. Set clock with correct time of day. Try Bake or Broil function again. If a fault code appears again, press OFF to clear the error code and contact your servicer.
Poor baking results	<ul style="list-style-type: none"> Many factors effect baking results. Use proper oven rack position. Center food in the oven and space pans to allow air to circulate. Preheat oven to the set temperature before placing food in the oven. Try adjusting the recipe's recommended temperature or baking time. See "Adjusting Oven Temperatures" on page 29 if you feel the oven is too hot or cold.
Quick Preheat performs poorly	<ul style="list-style-type: none"> Quick Preheat not used correctly. This cooking function is intended for convenience, precooked, and other specific foods. See "Quick Preheat" on page 16 and follow tips for best using this feature.
Appliance is not level	<ul style="list-style-type: none"> Poor installation. Place oven rack in center of oven. Place a level on the oven rack to check if oven has been properly installed. Kitchen cabinet alignment may make oven appear not level. Be sure cabinets are square and have sufficient room for appliance clearance. If cabinets are not square or are built in too tightly, contact builder or installer to make appliance accessible.
Cannot move appliance easily Appliance must be accessible for service	<ul style="list-style-type: none"> Cabinets not square or are built in too tightly. Contact builder or installer to make appliance accessible.
Appliance does not operate	<ul style="list-style-type: none"> Electrical power outage. Check house lights to be sure. Call your local electric company for service outage information. Service wiring is incomplete. Call 1-800-944-9044 for assistance.
Flames inside oven or smoking from oven vent	<ul style="list-style-type: none"> Excessive spills in oven. Grease or food spilled onto oven bottom or oven cavity. Wipe up excessive spills before starting oven. If flames or excessive smoke are present when broiling, see "Setting Broil" on page 20.
Oven does not operate.	<ul style="list-style-type: none"> The time of day is not set. The oven clock must first be set in order to operate the oven. See "Setting the Clock" on page 14. Be sure oven controls are set properly. See "Oven Control Features" beginning on page 13 and review instructions for the desired cooking function in this manual.

BEFORE YOU CALL

Oven smokes excessively when broiling.	<ul style="list-style-type: none">• Incorrect setting. See “Setting Broil” on page 20.• Meat too close to the broil element. Reposition rack to provide proper clearance between the meat and broil element. Remove excess fat from meat. Cut remaining fatty edges to prevent curling, but do not cut into lean.• Grease build up on oven surfaces. Regular cleaning is necessary when broiling frequently. Grease or food splatters will cause excessive smoking.
Oven racks discolored or do not slide easily.	<ul style="list-style-type: none">• Clean by using a mild abrasive cleaner following manufacturer's instructions. Rinse with clean water, dry, and replace in oven.
Oven light does not work.	<ul style="list-style-type: none">• Be sure the oven light is secure in the socket. “See “Replacing the Oven Light” on page 35.
Fan noise occurring after the oven is turned off	<ul style="list-style-type: none">• Some models are equipped with a cooling fan that runs during the cooking process to cool internal electronic components. It is normal for this fan to continue to run for an extended period of time, even when the oven has been turned off.

WARRANTY

Your appliance is covered by a one year limited warranty. For one year from your original date of purchase, Electrolux will pay all costs for repairing or replacing any parts of this appliance that prove to be defective in materials or workmanship when such appliance is installed, used and maintained in accordance with the provided instructions.

Exclusions

This warranty does not cover the following:

1. Products with original serial numbers that have been removed, altered or cannot be readily determined.
2. Product that has been transferred from its original owner to another party or removed outside the USA or Canada.
3. Rust on the interior or exterior of the unit.
4. Products purchased "as-is" are not covered by this warranty.
5. Food loss due to any refrigerator or freezer failures.
6. Products used in a commercial setting.
7. Service calls which do not involve malfunction or defects in materials or workmanship, or for appliances not in ordinary household use or used other than in accordance with the provided instructions.
8. Service calls to correct the installation of your appliance or to instruct you how to use your appliance.
9. Expenses for making the appliance accessible for servicing, such as removal of trim, cupboards, shelves, etc., which are not a part of the appliance when it is shipped from the factory.
10. Service calls to repair or replace appliance light bulbs, air filters, water filters, other consumables, or knobs, handles, or other cosmetic parts.
11. Surcharges including, but not limited to, any after hour, weekend, or holiday service calls, tolls, ferry trip charges, or mileage expense for service calls to remote areas, including the state of Alaska.
12. Damages to the finish of appliance or home incurred during installation, including but not limited to floors, cabinets, walls, etc.
13. Damages caused by: services performed by unauthorized service companies; use of parts other than genuine Electrolux parts or parts obtained from persons other than authorized service companies; or external causes such as abuse, misuse, inadequate power supply, accidents, fires, or acts of God.

DISCLAIMER OF IMPLIED WARRANTIES; LIMITATION OF REMEDIES

CUSTOMER'S SOLE AND EXCLUSIVE REMEDY UNDER THIS LIMITED WARRANTY SHALL BE PRODUCT REPAIR OR REPLACEMENT AS PROVIDED HEREIN. CLAIMS BASED ON IMPLIED WARRANTIES, INCLUDING WARRANTIES OF MERCHANTABILITY OR FITNESS FOR A PARTICULAR PURPOSE, ARE LIMITED TO ONE YEAR OR THE SHORTEST PERIOD ALLOWED BY LAW, BUT NOT LESS THAN ONE YEAR. ELECTROLUX SHALL NOT BE LIABLE FOR CONSEQUENTIAL OR INCIDENTAL DAMAGES SUCH AS PROPERTY DAMAGE AND INCIDENTAL EXPENSES RESULTING FROM ANY BREACH OF THIS WRITTEN LIMITED WARRANTY OR ANY IMPLIED WARRANTY. SOME STATES AND PROVINCES DO NOT ALLOW THE EXCLUSION OR LIMITATION OF INCIDENTAL OR CONSEQUENTIAL DAMAGES, OR LIMITATIONS ON THE DURATION OF IMPLIED WARRANTIES, SO THESE LIMITATIONS OR EXCLUSIONS MAY NOT APPLY TO YOU. THIS WRITTEN WARRANTY GIVES YOU SPECIFIC LEGAL RIGHTS. YOU MAY ALSO HAVE OTHER RIGHTS THAT VARY FROM STATE TO STATE.

If You Need Service

Keep your receipt, delivery slip, or some other appropriate payment record to establish the warranty period should service be required. If service is performed, it is in your best interest to obtain and keep all receipts. Service under this warranty must be obtained by contacting Electrolux at the addresses or phone numbers below.

This warranty only applies in the USA and Canada. In the USA, your appliance is warranted by Electrolux Major Appliances North America, a division of Electrolux Home Products, Inc. In Canada, your appliance is warranted by Electrolux Canada Corp. Electrolux authorizes no person to change or add to any obligations under this warranty. Obligations for service and parts under this warranty must be performed by Electrolux or an authorized service company. Product features or specifications as described or illustrated are subject to change without notice.

USA
1.800.944.9044
Electrolux Home Products, Inc.
10200 David Taylor Drive
Charlotte, NC 28262



Canada
1.800.265.8352
Electrolux Canada Corp.
5855 Terry Fox Way
Mississauga, Ontario, Canada
L5V 3E4