

PRG364JDG

36-INCH GAS PRO GRAND® RANGE WITH GRIDDLE

PROFESSIONAL SERIES, COMMERCIAL-DEPTH, PORCELAIN COOKTOP SURFACE



Also Available:
PRL364JDG - LP

FEATURES & BENEFITS

- ★ - Patented Pedestal Star® Burner with QuickClean Base® designed for easy surface cleaning and superior heat spread for any size pan
- ★ - Powerful 22,000 BTU (NG) burner (front right)
- ★ - Precision simmering capabilities as low as 100°F (375 BTU) with 4 ExtraLow® Simmer burners
- ★ - SoftClose® hinges for ultra smooth closing of the oven door
- ★ - Superfast 2-hour self-clean mode—fastest in the industry

TECHNICAL DETAILS

| | |
|------------------------|-----------------------------|
| Circuit Breaker (A) | 20 A |
| Volts (V) | 120 V |
| Frequency (Hz) | 60 Hz |
| Plug Type | 120V-3 Prong |
| Power Cord Length (in) | 96" |
| Energy Source | Gas |
| Gas Type | Natural Gas 15 mbar (USA) |
| Alternative Gas Type | Liquid Gas 27, 5 mbar (USA) |

SEE PAGE 2 FOR OPTIONAL ACCESSORIES

GENERAL PROPERTIES

| | |
|-------------------------------------|--|
| Oven Capacity | 5.5 cu. ft. |
| Cooking Modes - Main / Large Cavity | Bake, Convection Bake, Broil, Roast, Self Clean, Proof |
| Cooking Modes - Small Cavity | N/A |
| Programs | Heating-up Control, Meat Probe, Sabbath Function |
| Cleaning Type | Self Clean |
| Type of Grate | Continuous Cast Iron |
| Controls | Metal Knobs and LCD Display |
| Warming Drawer | No |
| Sealed Burners | Yes |

OVEN PERFORMANCE

| | |
|------------------|-----------------|
| Bake Power | 30,000 BTU (NG) |
| Broil Power | 17,000 BTU (NG) |
| Convection Power | N/A |

BURNER PERFORMANCE

| | |
|---|-----------------------|
| Total Number of Cooktop Burners | 4 + Griddle |
| Total Cooktop BTU | 106,000 (NG) |
| Power of Front Left Burner BTU | 18,000-3,000 XLO (NG) |
| Power of Back Left Burner BTU | 18,000-3,000 XLO (NG) |
| Power of Back Center Burner BTU | N/A |
| Power of Front Center Burner BTU | N/A |
| Power of Center 12" Electric Griddle (W) | 1,630 W |
| Power of Center 12" Electric Grill (W) | N/A |
| Power of Far Right 12" Electric Griddle (W) | N/A |
| Power of Back Right Burner BTU | 18,000-3,000 XLO (NG) |
| Power of Front Right Burner BTU | 22,000-3,000 XLO (NG) |

DIMENSIONS & WEIGHT

| | |
|---|---------------------------------------|
| Overall Appliance Dimensions (HxWxD) (in) | 35 7/8"–36 3/4" x 35 15/16" x 28 1/2" |
| Required Cutout Size (HxWxD) (in) | 35 7/8"–36 3/4" x 36" x 24"–25 1/8" |
| Adjustable Range Height (in.) | 7/8" |
| Net Weight (lbs) | 360 lbs |

ACCESSORIES (INCLUDED)

3 X Telescopic Rack, 1 X Temperature Sensor, 1 X Island Trim, 1 X Grill Plate, 1 X Broiler Pan

WARRANTY

| | |
|---|--------|
| Limited Warranty, Entire Appliance, Parts and Labor | 2 Year |
|---|--------|







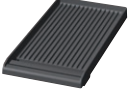

PRG364JDG

36-INCH GAS PRO GRAND® RANGE WITH GRIDDLE

PROFESSIONAL SERIES, COMMERCIAL-DEPTH, PORCELAIN COOKTOP SURFACE



ACCESSORIES (OPTIONAL)

| | | | | | |
|---|---|---|--|---|---------------------------------------|
|  | PA12GRILLN Pro Grill |  | PAGRIDDLEN Griddle for Indoor Electric Grill |  | PAGRIDDLE Griddle |
|  | PA12CVRJ 12" Pro Grill / Griddle Cover |  | PA12CHPBLK 12" Cutting Board |  | PWOKRINGHC Wok Ring |
|  | PA36JLBG 9" Low Backguard |  | PA36JTKG Toekick |  | PAKNOBLUNG Blue Knob Pro Grand Kit |

36-INCH RANGE AND CUTOUT DIMENSIONS

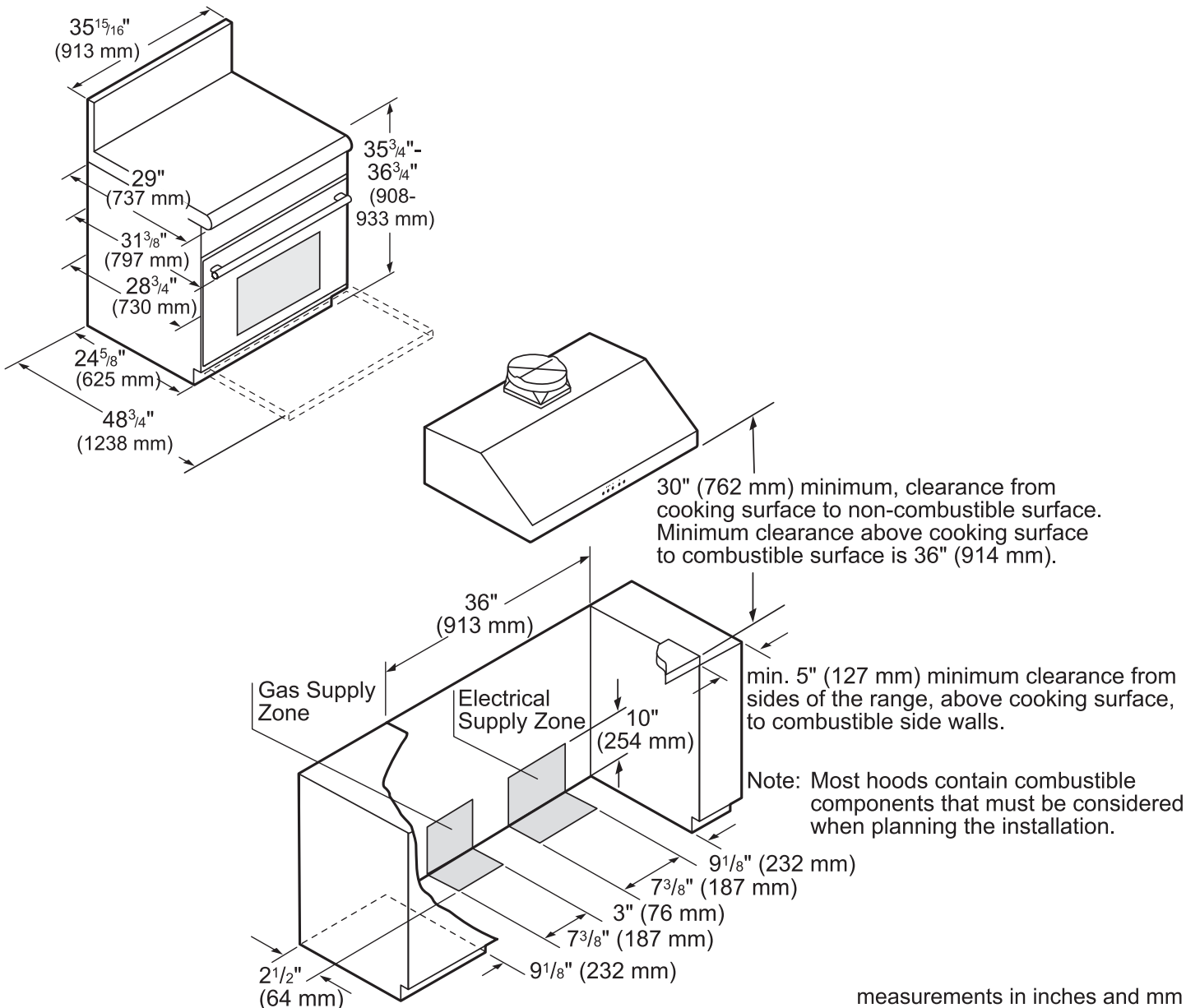

PRG364JDG
36-INCH GAS PRO GRAND® RANGE WITH GRIDDLE
 PROFESSIONAL SERIES, COMMERCIAL-DEPTH, PORCELAIN COOKTOP SURFACE



36-INCH RANGE CUTOUT DIMENSIONS

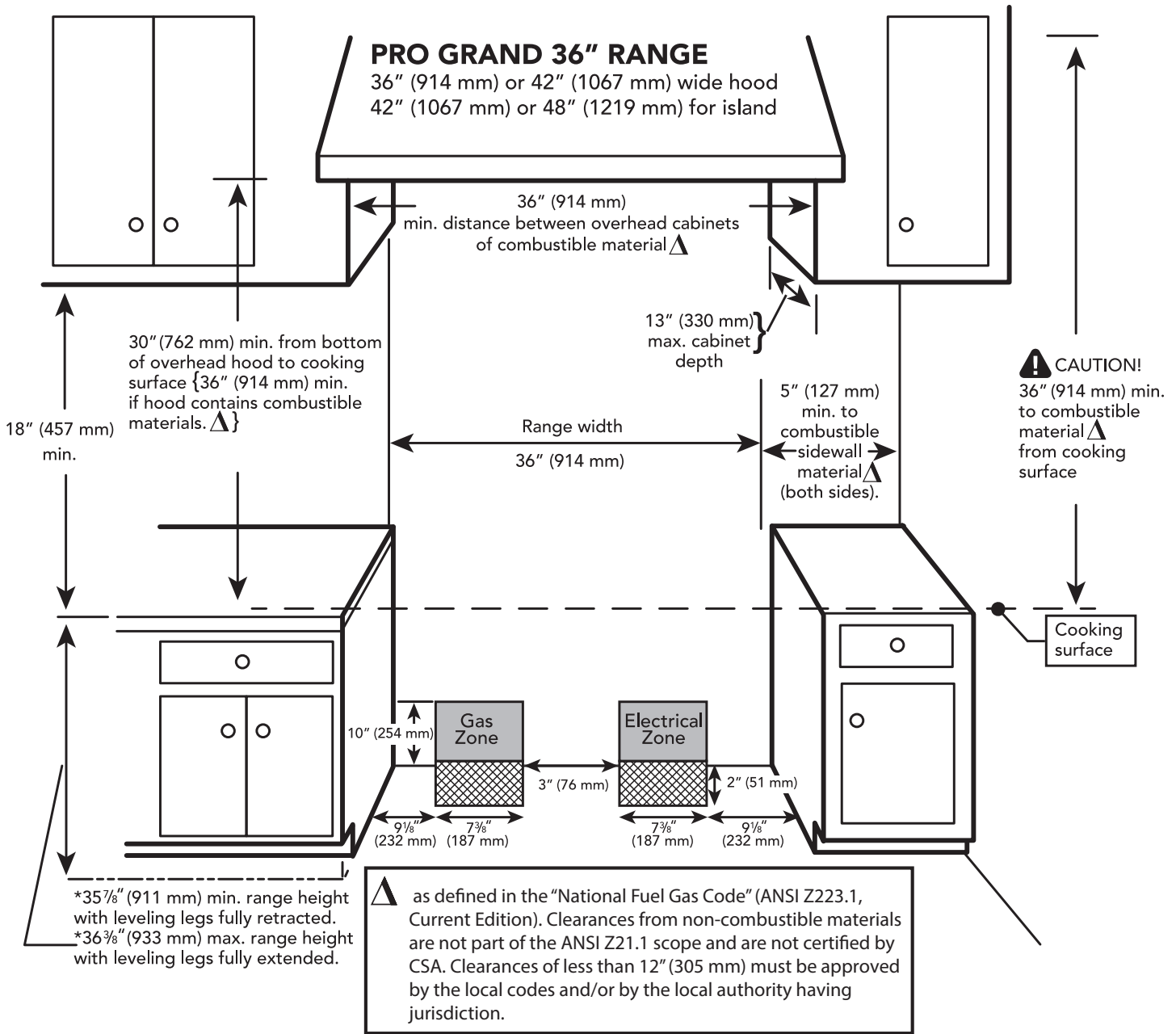

PRG364JDG
36-INCH GAS PRO GRAND® RANGE WITH GRIDDLE
 PROFESSIONAL SERIES, COMMERCIAL-DEPTH, PORCELAIN COOKTOP SURFACE



36-INCH RANGE DIMENSIONS AND CLEARANCE REQUIREMENTS WITH "LOW BACK"

NOTE: A 36-inch minimum clearance is required between the top of the cooking surface and the bottom of an unprotected cabinet. A 30-inch clearance can be used when the bottom of the wood or metal cabinet is protected by not less than 1/4 inch of a flame retardant material covered with not less than No. 28 MSG sheet steel, 0.015 inch (0.4 mm) thick stainless steel, 0.024 inch (0.6 mm) aluminum, or 0.020 inch (0.5 mm) thick copper.

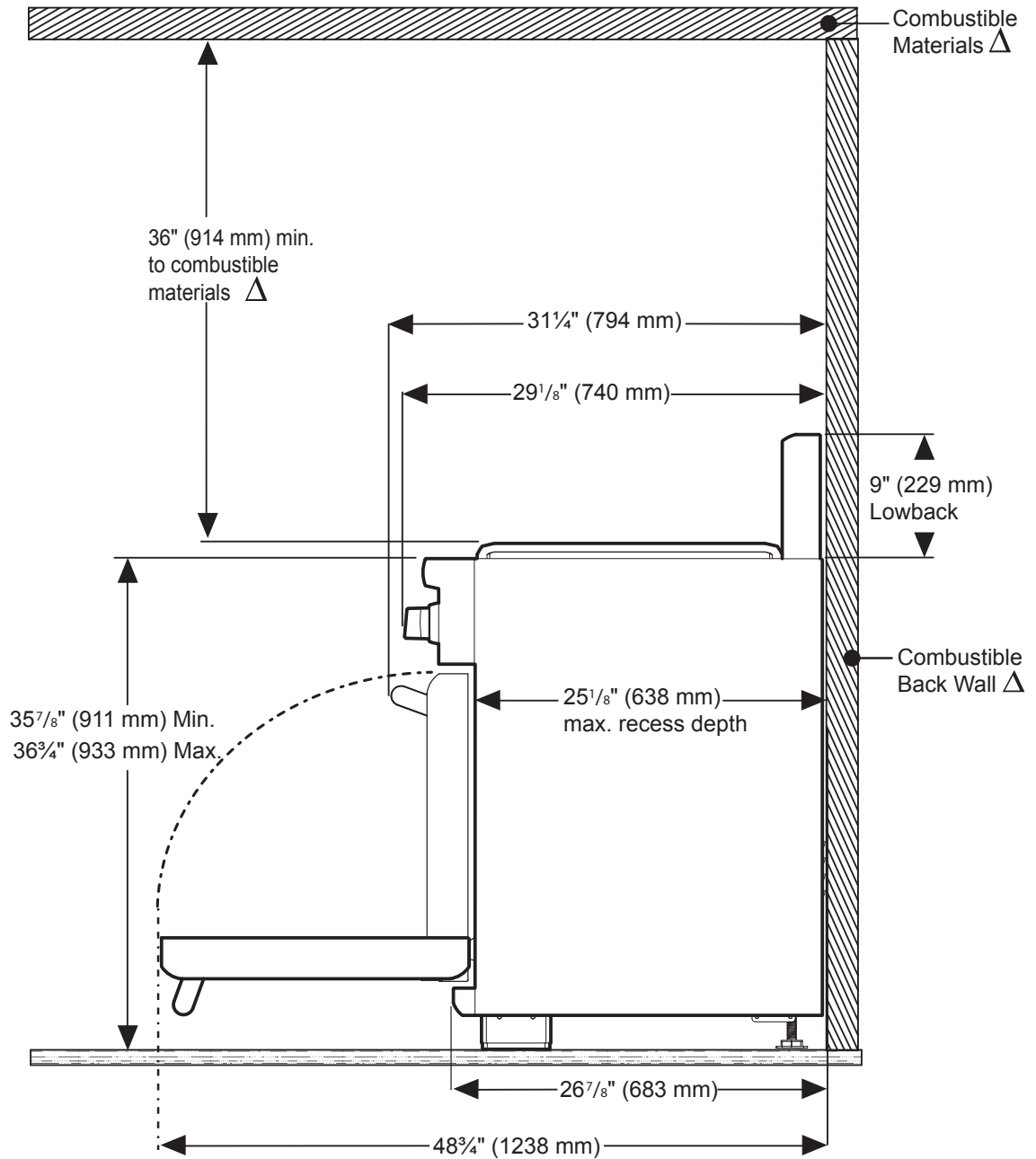

△ As defined in the "National Fuel Gas Code" (ANSI Z223.1, Current Edition). Clearances from non-combustible materials are not part of the ANSI Z21.1 scope and are not certified by CSA. Clearances of less than 12" (305 mm) must be approved by the local codes and/or by the local authority having jurisdiction.

PRG364JDG
36-INCH GAS PRO GRAND® RANGE WITH GRIDDLE
 PROFESSIONAL SERIES, COMMERCIAL-DEPTH, PORCELAIN COOKTOP SURFACE



36-INCH RANGE DIMENSIONS AND CLEARANCE REQUIREMENTS WITH "FLUSH ISLAND TRIM"

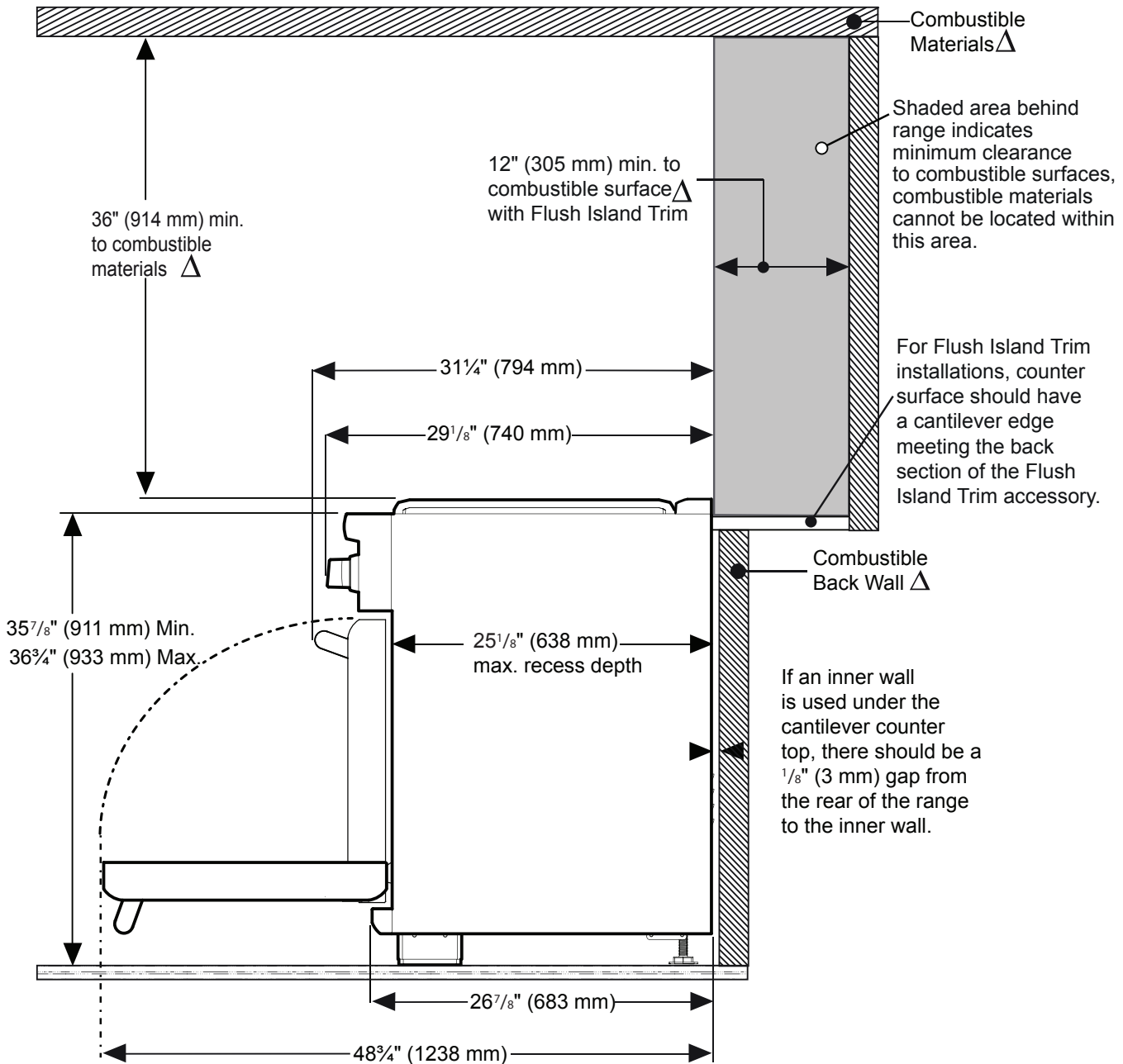

△ As defined in the "National Fuel Gas Code" (ANSI Z223.1, Current Edition). Clearances from non-combustible materials are not part of the ANSI Z21.1 scope and are not certified by CSA. Clearances of less than 12" (305 mm) must be approved by the local codes and/or by the local authority having jurisdiction.

These warranties give you specific legal rights and you may have other rights that vary from state to state. Full warranty and limited warranty from date of installation. For complete warranty details, refer to your Use & Care manual, or ask your dealer.

Specifications are for planning purposes only. Refer to installation instructions and consult your countertop supplier prior to making counter opening. Consult with a heating and ventilation engineer for your specific ventilation requirements. For the most detailed information, refer to installation instructions accompanying product or write to Thermador indicating the model number. Specifications are correct at time of printing. Thermador reserves the right to change product specifications or design without notice. Some models are certified for use in Canada. Thermador is not responsible for products that are transported from the U.S. for use in Canada.