



REF31BMFX

31 inch bottom mount freestanding refrigerator

USER'S OPERATION MANUAL

Before operating this unit, please read this manual thoroughly, and retain for future reference



English

Thank you for choosing Bertazzoni. We are sure you will find your new refrigerator a pleasure to use, before you use the appliance, we recommend that you read through these instructions carefully, which provide important details regarding installation and use. Please keep a copy for future reference.

Contents

Important safety instructions.....	2	Cleaning and care.....	13
Refrigerator Overview.....	5	Helpful hints and tips.....	14
Installing your new appliance.....	6	Troubleshooting.....	15
Display control	10	Disposal of the appliance.....	18
Using your refrigerator.....	12	Warranty statement	19

Important Safety Instructions



Read and follow all safety messages. Save these instructions.

This safety alert symbol will help you understand situations and hazards that may cause injury or death.



WARNING

The WARNING alert means a potentially hazardous situation. Serious injury or death may occur if not avoided.



DANGER

The DANGER alert means an imminently hazardous situation. Serious injury or death may occur if not avoided.



CAUTION

The CAUTION alert means a potentially hazardous situation. Moderate or minor injury may occur if not avoided.



WARNING

1. Please ensure that everyone using this appliance is familiar with its operations and safety features. This appliance is not intended for use by persons (including children) with reduced physical, sensory or

mental capabilities, unless supervised or properly instructed.

2. This appliance is intended to be used in residential households and similar domestic applications.

3. Keep explosive and flammable substances away from unit. Do not store similar products in the refrigerator.

4. Disconnect power before servicing.

5. Use nonflammable cleaner.

6. Use 2 or more people to remove old unit and for installation of the new unit .

7. Do not use mechanical devices or other means to accelerate the defrosting process, other than those recommended by the manufacturer.

8. Do not damage the refrigerant circuit.

9. Do not use electrical appliances inside the food storage compartments of the appliance, unless they are of the type recommended by the manufacturer.

10. The instructions include the following wording regarding the use of extension cords:

- Do not use an extension cord or ungrounded (two prong) adapters.
- If the supply cord is damaged, it must be replaced by the manufacturer, its service agent or similarly qualified persons in

order to avoid a hazard.

11. Keep ventilation openings, in the appliance enclosure or in the built-in structure, clear of obstructions.

DANGER

To avoid the risks that are always present when using an electric appliance, it is recommended that you pay attention to the instructions about electricity below.

1. The appliance requires single phase 115V/60Hz power supply. It has a power cord that has a 3-prong grounding plug that minimizes the possibility of electrical shock. This appliance must be grounded. Do not remove grounding prong or modify the power plug.

2. The unit should be plugged into a dedicated electrical outlet that meets all current standards and requirements. Do not plug anything else into the same outlet and ensure the appliance is the only thing plugged into the entire circuit. It should have its own dedicated breaker. Otherwise, this may overload the circuit and cause a fire.

3. The power plug must be accessible when the appliance is installed.

4. The appliance should not be turned off with a switch or other device.

5. Make sure that the plug is not pinched or damaged. Otherwise, it may cause short circuit, electric shock, overheating and could become a potential fire hazard

6. Do not insert the power plug if the socket is loose, there is a risk of electric shock or fire.

7. Switch off the appliance and disconnect it from the main power before it is cleaned or moved.

8. Never unplug the appliance by pulling on the electrical cord. Always grip the plug firmly and pull straight out from the socket to prevent damaging the power cord.

9. Do not operate the appliance without the cover over interior lighting.

10. Any electrical component must be replaced or repaired by a qualified electrician or authorized service engineer. Only genuine replacement parts should be used.

11. To avoid eye injury, do not look directly into the LED light located in the refrigerator compartment. If it is not functioning correctly, consult a qualified, registered electrician or replace it in accordance with the "cleaning and care" chapter.

12. The refrigerant isobutane (R600a) is contained within the refrigerant circuit of the appliance. During transportation and installation of the appliance, ensure that none of the components of the refrigerant circuit becomes damaged. The refrigerant (R600a) is flammable.

13. Risk of child entrapment. Before you throw away your old appliance:

- Take off the doors
- Leave the shelves in place so that children may not easily climb inside.

CAUTION

1. Do not store products which contain flammable propellants (e.g. spray cans) or explosive substances in the appliances.

2. Avoid open flames (candles, lamps *etc.*) and sources of ignition.

3. Thoroughly ventilate the room in which the appliance is situated.

4. Unpack and check through the appliance. Should any damage be evident, do not plug in the appliance but contact the shop immediately from which you purchased it. Keep all packing materials in this case.

5. We recommend that you wait for 4 hours before connecting the appliance to allow the refrigerant to flow back into the compressor.

General safety and daily use

It is important to use your appliance safely. We recommend that you follow the guidelines below.

- We recommend that you keep this user's manual with the appliance for future reference.

- This appliance is intended to be used in households and similar applications such as:

- Staff kitchen-areas in shops, offices and other working environments;

- Clients in hotels, motels and other residential types of environment;

- Bed and breakfast type of environments;

- Catering and similar non-retail applications.

- Children should always be supervised when using the appliance to ensure proper and safe usage.

- Store any food in accordance with the storage instructions from the manufacturer.

- Do not try to repair the appliance yourself. It is dangerous to alter the specifications or modify this product in any way. Any damage to the power cord may cause a

short circuit, fire or electric shock.

- Do not place excess food directly against the air outlet on the rear wall of both the refrigerator and freezer compartment, as it affects sufficient air circulation.

- Do not place hot items near the plastic components of this appliance.

- Frozen food must not be refrozen once it has been thawed out.

- Do not store bottled or canned drinks (especially carbonated drinks) in the freezer compartment. Bottles and cans may explode.

- Use caution consuming popsicles or ice cubes straight from the freezer as this can cause freezer burn to the mouth and lips.

Safety for children and Individuals with health issues/disabilities

- Keep all packaging away from children to avoid risk of suffocation.

- Protect children from being scalded by touching the compressor at the rear bottom of appliance

- Do not place items on top of the appliance as this could cause injury should they fall off.

- Never allow children to play with the appliance by hanging or standing over or on the doors, racks, shelves and drawers etc.

CALIFORNIA PROPOSITION 65



WARNING: Cancer and Reproductive Harm –www.P65Warnings.ca.gov.



ADVERTENCIA: Cáncer y Daño Reproductivo –www.P65Warnings.ca.gov.



AVERTISSEMENT: Cancer et Troubles de l'appareil reproducteur

– www.P65Warnings.ca.gov.

Refrigerator Overview



- | | | | |
|-----------------|--------------------------|-------------------|-------------------|
| ① Control panel | ⑦ Crisper | ⑬ Roller | ⑲ Little door bin |
| ② Cabinet | ⑧ Twist ice Tray | ⑭ Freezer Door | ⑳ Fridge Door |
| ③ Door switch | ⑨ Upper freezer drawer | ⑮ Freezer Gasket | ㉑ Fridge Gasket |
| ④ Glass shelf | ⑩ Middle freezer drawer | ⑯ Handle | |
| ⑤ Wind Channel | ⑪ Lower freezer drawer | ⑰ Low door bin | |
| ⑥ Crisper Cover | ⑫ Adjustable bottom foot | ⑱ Middle door bin | |

Note !

- Layout may vary from model to model.
- To obtain the best energy efficiency from this product, please place all shelves, drawers and baskets on their original position as per the illustration above.

Installing Your New Appliance

Before using the appliance for the first time, Please take note of the following important points.

WARNING

For proper installation, this refrigerator must be placed on a level surface of hard material that is the same height as the rest of the flooring. This surface should be strong enough to support a fully loaded refrigerator.

The rollers, which are not castors/swiveling wheels, should be only used for forward or backward movement. Moving the refrigerator sideways may damage your floor and the rollers.



Ventilation of appliance



In order to improve efficiency of the cooling system and save energy, it is necessary to maintain proper ventilation around the appliance. For this reason, enough clear space should be available around the refrigerator.

Suggestion:

It is advisable for there to be at least 2 inches of clearance from the back of the fridge to the wall, at least 3/8 inches of clearance from its top, at least 3/8 inches from its side to the wall and a clear space in front to allow the refrigerator doors to

open 130°. As shown in following diagrams.

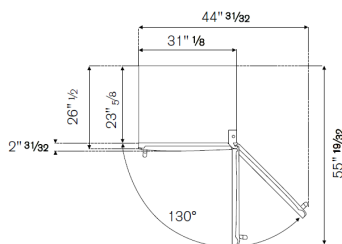
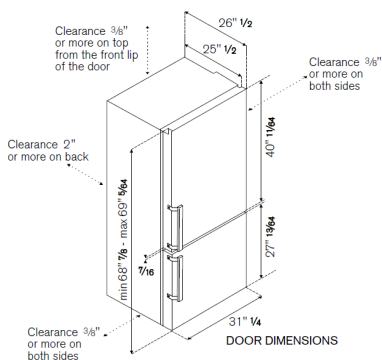

Note:

- Place your appliance in a dry place to avoid moisture.
- Keep the appliance out of direct sunlight, rain or frost. Position the appliance away from heat sources such as stoves, fire or heaters.

Leveling of appliance



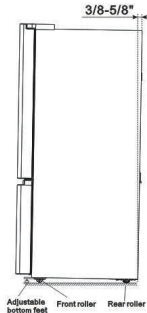



- For enough leveling and air circulating in the lower rear section of the appliance, the bottom feet may need to be adjusted. You can adjust them manually or by using a suitable tool.
- To allow the doors to self-close, tilt the top backwards by 3/8 – 5/8 inch (10mm~15mm).



Reversing the door

The side at which the door opens can be changed, from the right side (as supplied) to the left side if required.

Warning! When reversing the door, the appliance must not be connected to the mains. Make sure that the plug is removed from the mains socket.

Additional parts (in the plastic bag)	
	
Allen Wrench(4mm)	
	
Left Hinge	Left Hinge Cover
	
Right Screw Cover	Left Middle Hinge
	
Left Stop Block*2	Left Door Stopper*2

Note: If required, the refrigerator may be positioned on its back in order to gain access to the base, it should be rested on

soft foam packaging or similar material to avoid damaging the backboard of the refrigerator. To reverse the door, the following steps are recommended.

1. Stand the refrigerator upright. Open the door to **remove** all door racks (to avoid damage) and then close the door.

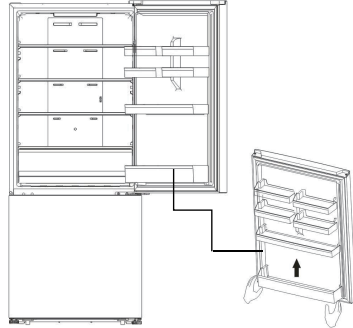

Caution!

slightly squeeze the door rack from two sides towards the center and inside of the door rack, then move it upward when taking out the upper rack and lower rack.

2. Remove right upper hinge cover ① on top of the cabinet. Remove the 3 screws ② used for fixing the right upper hinge part (see picture below) and dismantle the upper hinge parts ③.

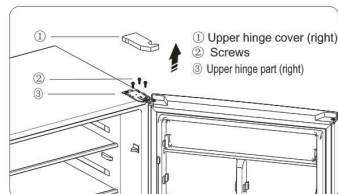
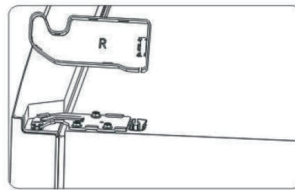

3. Remove screw cover from the left-front corner of cabinet with flat head screwdriver and install screw cover-right to the right front corner. Put the upper hinge cover(right) and upper hinge part (right) into the plastic bag.

4. Remove the upper door from the middle hinge by carefully lifting the door straight up.

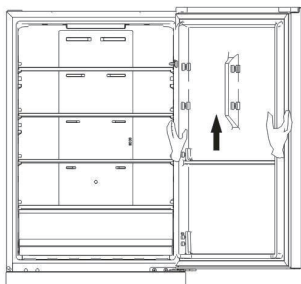

5. Place the upper door on a smooth surface with its panel upwards. Loosen screw ③ and take down part ② and part ①, Install replacement door stopper-left provided (in the plastic bag attached) and left stop block to the left side with screw ③. Keep part ① and ② with the appliance for future reference.

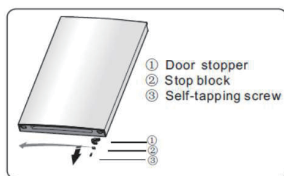

6. Use the Allen wrench(provided in the plastic bag) to loosen screws used to fix the right middle hinge and remove right middle hinge. Then remove the lower door.

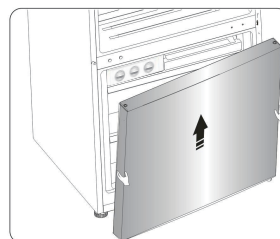
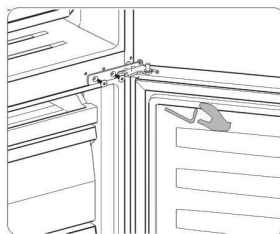

7. Place the lower door on a smooth surface with its panel upwards. Loosen screw ③ and dismount part ② and part ①, Install replacement door stopper-left provided (in the plastic bag) and left stop block to the left side with screw ③. Keep part ① and ② with the appliance for future reference.

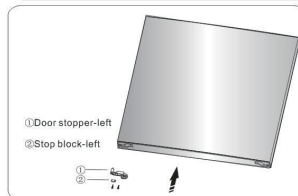
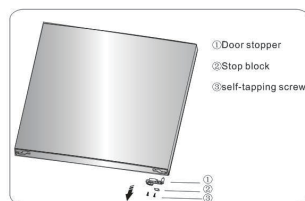

8. Change screw hole covers and screw on middle cover plate from left to right (as shown in figure below).

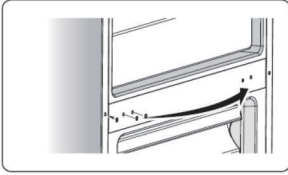

9. Lie the refrigerator backwards, Remove ④ (right), Remove three self-tapping screws from the lower hinge part(right). Loosen the lower hinge axis then install it on the reverse hole site, and tighten into position(change it into left hinge part). Remove the lower hinge part to the left-bottom corner of the cabinet, Then fix it with 3 screws, finally install part ④ on the left-bottom and right-bottom of cabinet.

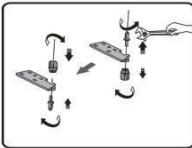
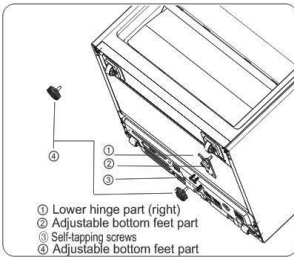

10. Stand the refrigerator upright and carefully slot the lower door onto the lower hinge pin and hold in position. install middle hinge-left (in the plastic bag) ensuring the lower door in secured place.

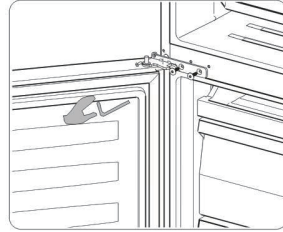
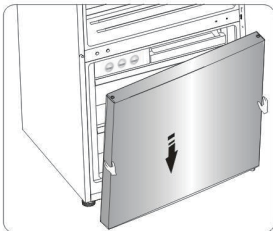

11. Carefully slot the upper door onto the middle hinge pin and hold in position. Move the upper door to an appropriate position, adjust left upper hinge(in the plastic bag) and upper door, then fit the hinge pin into the hinge hole at the top and the door to secure the door in place. Then fix the upper hinge part with screws (Please carefully hold upper door by hand when installing).

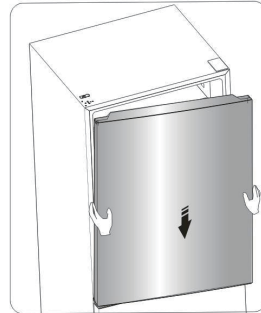

12. Assemble the left hinge cover provided (in the plastic bag) to match the hinge, install the door racks to original position. Keep the right hinge cover with the appliance for future reference.

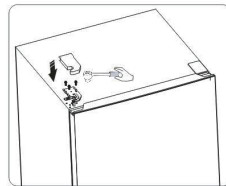

Display Control

Use the appliance according to the following guidelines. The functions are described below in more detail.



Controlling the temperature

We recommend that when you start your refrigerator for the first time, the temperature for the refrigerator is set to 39°F(4°C) and the freezer is set to 0°F(-18°C). If you want to change the temperature, follow the instructions below. Caution! When you set a temperature, you set an average temperature for the whole refrigerator cabinet. Temperatures inside each compartment may vary from the temperature displayed on the panel, depending on how much food you store and where you place them. Ambient temperature may also affect the actual temperature inside the appliance.

1. °F /°C

To toggle between Celsius and Fahrenheit on the display, press and hold the "TEMP." button for three seconds.

2. Fridge



Fridge

Press the "ZONE" button until the "Fridge" icon lights up, then press the "TEMP." button to select a temperature setting. If you have set the temperature type to Fahrenheit, the temperature settings cycle from 44°F to 34°F.

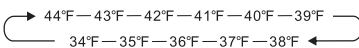

If you have set the temperature type to Celsius, the temperature settings cycle from 7°C to 1°C.

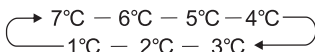

3. Freezer



Freezer

Press the "ZONE" button until the "Freezer" icon lights up, then press the "TEMP." button to select a temperature setting.

If you have set the temperature type to Fahrenheit, the temperature settings cycle from 7°F to -11°F.

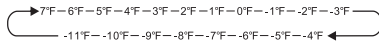

If you have set the temperature type to Celsius, the temperature settings cycle from -14°C to -24°C.

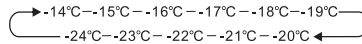

4. Super Cool



Super Cool

Super Cool can refrigerate the food quicker and keep food fresh for a longer period. This is useful to activate before inserting a large amount of warm/room temperature food.

- Press the "MODE" button to activate this function. The "Super Cool" icon will be illuminated and the fridge temperature indicator will display 34°F (1°C).
- Super Cool will automatically turn off after 3 hours.
- When super Cool function is on you can turn it off by pressing the "MODE" or setting fridge temperature. To manually turn off the Super Cool function, the fridge

temperature setting will revert back to the previous setting.

5. Energy saving



Press the "MODE" button to turn on the Energy saving function, the "Energy saving" icon will be illuminated.

- When the Energy saving function is on, the temperature of fridge is automatically switched to 43°F (6°C) and the temperature of freezer is automatically switched to 1°F(-17°C).
- When the Energy saving function is on you can switch it off by pressing the "MODE" or "TEMP." button and the refrigerator temperature setting will revert back to the previous setting.

6. Super Freeze



Super Freeze will quickly lower the temperature within the freezer so food will freeze faster than usual. This feature also helps to keep vitamins and nutrition of fresh food fresh for longer period.

- Press the "MODE" button to activate this function. The "Super Freeze" icon will be illuminated and the temperature for the freezer is set to -11°F (-24°C).
- Super Freeze will automatically turn off after 52 hours.
- When the Super Freeze function is on you can turn it off by pressing the "MODE" or setting freezer temperature. To manually turn off the Super Freeze function, the freezer temperature setting will revert back to the previous setting.

NOTE: When you select the Super Freeze function, ensure there are no bottled or canned drinks (especially carbonated drinks) in the freezer compartment. Bottles and cans may explode.

7. POWER



Press and hold the "POWER" button  for three seconds to turn the power function on or off.

- When the power function is on, the  icon lights and the display board will show "OF". If no buttons have been pressed, the display board will turn off about 1 minute later.
- IF you want to turn off the power function, make sure the display board is lighting up. IF not, you can press any button to light up the display board and then turn power function off.

NOTE:

When the power function is on, the refrigerator stops cooling.

8. Door Alarm

- When the door of fridge is open over 2 minutes, the control panel will show "dr".
- To save energy, do not keep the door open for a long time when using the refrigerator.

Using your refrigerator

Your appliance has the accessories as the “Description of the appliance” showed in general, with this part instruction you can have the right way to use them. We recommend that you read through them carefully before using the appliance.

Door rack

It is suitable for the storage of canned liquid, bottled drinks and packed food, etc. Do not place too many heavy things in the racks.

Shelf in Refrigerator chamber

1. There are shelves in refrigerator chamber, and they can be taken out to be cleaned.



2. The crisper is suitable for storage of vegetables and fruit, etc.

Firstly Pull the crisper out in level, Secondly tip it up before taking it out. Using to the opposite sequence you can position the crisper correctly

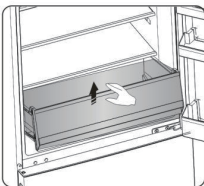
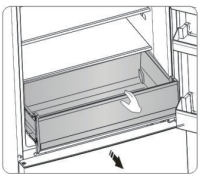

Freezer chamber

The freezer chamber is suitable for storage of foods required to be frozen, such as meat, ice.

Caution! Never close the freezer door while the drawers, installation bracket, ice tray are extended. It may damage the unit. Ensure that drink bottles are not left in the freezer for a longer time than needed as freezing liquid may cause the bottle to break.

Twistable ice tray

Twistable ice tray produce abundant ice cubes.

1. Pull out the twistable ice tray from the installation bracket.
2. Fill with drinking water below the maximum level mark.
3. Place the filled ice tray back to bracket.
4. wait for around 3 hours, twist the knobs clockwise and the ice will drop into the ice box below.

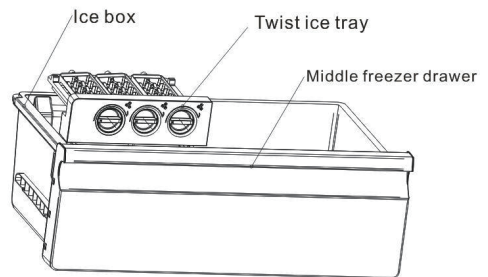

Cleaning and care

For hygienic reasons the appliance (including exterior and interior accessories) should be cleaned regularly at least every two months.



CAUTION

The appliance must not be connected to the mains during cleaning. Danger of electrical shock! Before cleaning switch the appliance off and remove the plug from the mains socket.

Exterior cleaning

To maintain good appearance of your appliance, it should be cleaned regularly.

- Spray water onto a cleaning cloth instead of spraying directly on the surface of the appliance. This helps ensure an even distribution of moisture to the surface.
- Clean the doors, handles and cabinet surfaces with a mild detergent and then wiped dry with a soft cloth.

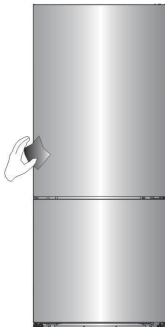

CAUTION

- Do not use sharp objects as they are likely to scratch the surface.
- Do not use Thinner, Car detergent, Clorox, ethereal oil, abrasive cleansers or organic solvent such as Benzene for cleaning. They may damage the surface

of the appliance and may cause fire.

Interior cleaning

You should clean the appliance interior regularly. It will be easier to clean when food stocks are low. Wipe the inside of the fridge freezer with a weak solution of bicarbonate of soda, and then rinse with warm water using a wrung-out sponge or cloth. Wipe completely dry before replacing the shelves and baskets. Thoroughly dry all surfaces and removable parts before putting them back into place.



Although this appliance automatically defrosts, a layer of frost may occur on the freezer compartment's interior walls if the freezer door is opened frequently or kept open too long. If the frost is too thick, choose a time when the freezer is nearly empty and proceed as follow:

1. Remove existing food and accessories baskets, unplug the appliance from the mains power and leave the doors open. Ventilate the room thoroughly to accelerate the process.
2. When defrosting is completed, clean the freezer as described above.

⚠ WARNING

Do not use sharp objects to remove frost from the freezer compartment. Only after the interior is completely dry should the appliance be switched back on and plugged back into the mains socket.

Door seals cleaning

Take care to keep door seals clean. Sticky food and drinks can cause seals to stick to the cabinet and tear when you open the door. Wash seal with a mild detergent and warm water. Rinse and dry it thoroughly after cleaning.

CAUTION

Only after the door seals are completely dry should the appliance be powered on

Replacing the LED light

Warning: The LED light must be replaced by a competent person. If the LED light is damaged, follow the steps below:

1. Unplug the refrigerator from the electrical outlet.
2. Locate the LED light on the inside of the refrigerator.
3. Remove the light cover. Insert a tool (tweezers or a screwdriver) along the side opening of the LED light cover. Pop open the side over the cover, grasp the exposed side and gently pull towards you to remove the item and expose the LED light.
4. Replace the new LED light.
5. Replace the light cover.

Helpful hints and tips**Energy saving tips**

We recommend that you follow the tips below to save energy.

- Try to avoid keeping the door open for long periods in order to conserve energy. Ensure the appliance is away from any sources of heat (Direct sunlight, electric oven or cooker *etc.*)
- Do not set the temperature colder than necessary.
- Do not store warm food or evaporating liquid in the appliance.



- Place the appliance in a well ventilated, humidity free, room. Please refer to Installing your new appliance chapter.
- If the diagram shows the correct combination for the drawers, crisper and shelves, do not adjust the combination as this is designed to be the most energy efficient configuration.

Hints for fresh food refrigeration

- Do not place hot food directly into the refrigerator or freezer, the internal temperature will increase resulting in the compressor having to work harder and will consume more energy.
- Do cover or wrap the food, particularly if it has a strong odor.
- Place food properly so that air can circulate freely around it.

Hints for refrigeration

- Meat (All Types) Wrap in polyethylene food: wrap and place on the glass shelf above the vegetable drawer. Always follow food storage times and use by dates suggested by manufacturers.
- Cooked food, cold dishes, *etc.*: They should be covered and may be placed on any shelf.
- Fruit and vegetables: They should be stored in the special drawer provided.

- **Butter and cheese:**

Should be wrapped in airtight foil or plastic film wrap.

- **Milk bottles:**

Should have a lid and be stored in the door racks.

Hints for freezing

- When first starting-up or after a period out of use, let the appliance run at least 2 hours on the higher settings before putting food in the compartment.

- Prepare food in small portions to enable it to be rapidly and completely frozen and to make it possible to subsequently thaw only the quantity required.

- Wrap up the food in aluminum foil or polyethylene food wraps which are airtight,
- Do not allow fresh, unfrozen food to touch food which is already frozen to avoid temperature rise of the latter.

- Iced products, if consumed immediately after removal from the freezer compartment, could possibly cause frost burns to the skin.

- It is recommended to label and date each frozen package in order to keep track of the storage time.

Hints for the storage of frozen food

- Ensure that frozen food has been stored correctly by the food retailer

- Once defrosted, food will deteriorate rapidly and should not be re-frozen. Do not exceed the storage period indicated by the food manufacturer.

Switching off your appliance

If the appliance needs to be switched off for an extended period, the following steps should be taken prevent mold.

1. Remove all food.
2. Remove the power plug from the mains socket.
3. Clean and dry the interior thoroughly.
4. Ensure that all the doors are wedged open slightly to allow air to circulate.

Troubleshooting

If you experience a problem with your appliance or are concerned that the appliance is not functioning correctly, you can carry out some easy checks before calling for service, please see below.



WARNING

1. Don't try to repair the appliance yourself. If the problem persists after you have made the checks mentioned below, contact a qualified electrician, authorized service engineer or the shop where you purchased the product.
2. A child entrapment warning statement is included in either the operating instructions or in a use and care manual provided with each refrigerator.

Problem	Possible Cause & Solution
Appliance is not working correctly	Check whether the power cord is plugged into the power outlet properly.

	<p>Check the fuse or circuit of your power supply, replace if necessary.</p> <p>The ambient temperature is too low. Try setting the chamber temperature to a colder level to solve this problem.</p> <p>It is normal that the freezer is not operating during the defrost cycle, or for a short time after the appliance is switched on to protect the compressor.</p>
Odors from the compartments	<p>The interior may need to be cleaned</p> <p>Some food, containers or wrapping cause odors.</p>
Noise from the appliance	<p>The sounds below are quite normal:</p> <ul style="list-style-type: none"> •Compressor running noises. •Air movement noise from the small fan motor in the freezer compartment or other compartments. •Gurgling sound like water boiling. •Popping noise during automatic defrosting. •Clicking noise before the compressor starts. •Clicking noise when water is supplied. •The motor running noises ice is supplied. <p>Other unusual noises are due to the reasons below and may require action:</p> <p>The cabinet is not level.</p> <p>The back of appliance is touching the wall.</p> <p>Bottles or containers have fallen or are rolling.</p>
The motor runs continuously	<p>It is normal to frequently hear the sound of the motor, it will need to run more when in following circumstances:</p> <ul style="list-style-type: none"> •Temperature setting is set colder than necessary •Large quantity of warm food has recently been stored within the appliance. •The temperature outside the appliance is high. •Doors are kept open too long or too often. •After installing the appliance or it has been switched off for a long time.
A layer of frost occurs in the compartment	<p>Check that the air outlets are not blocked by food and ensure food is placed within the appliance to allow enough ventilation. Ensure that door is fully closed. To remove the frost, please refer to the "Cleaning and Care" chapter.</p>
Temperature inside is too warm	<p>The doors may have been left open too long or too frequently; or the doors are kept open by some obstacle; or the appliance is located with insufficient clearance at the sides, back and top</p>
Temperature inside is too cold	<p>Increase the temperature by following the "Display Control " chapter.</p>
Doors can't be closed	<p>Check whether the top of the refrigerator is tilted back by</p>

easily	10~15mm to allow the doors to self-close, or if something inside is preventing the doors from closing.
The light is not working	<ul style="list-style-type: none">•The LED light may be damaged. Refer to replace LED lights in“ Cleaning and Care” chapter.•The control system has disabled the lights due to the door being kept open too long. Close and reopen the door to reactivate the lights.
Hear water bubbling in the refrigerator	This is normal. The bubbling comes from the refrigerant coolant liquid circulating through the refrigerator.

Disposal of the appliance

DANGER

It is prohibited to dispose of this appliance as household waste.

Packaging materials

Packaging materials with the recycle symbol are recyclable. Dispose of the packaging into a suitable waste collection container to recycle it.

Before disposal of the appliance

1. Pull out the main plug from the main socket.
2. Cut off the power cord and discard with the main plug.

WARNING

Potential Suffocation Hazard! Potential death or brain damage could occur. Remove doors to prevent potential suffocation.

1. To prevent potential suffocation hazard, remove your old refrigerators doors completely immediately. Leave shelves installed to help block children from climbing on or getting inside.
2. When disposing of the appliance do so only at an authorized waste disposal center. Do not expose to flame.

Refrigerators contain refrigerant and gases in the insulation. Refrigerant and gases must be disposed of professionally as they may cause eye injuries or ignition. Ensure that tubing of the refrigerant circuit is not damaged prior to proper disposal.

	Correct Disposal of this product
	<p>This symbol on the product or in its packing indicates that this product may not be treated as household waste. Instead, it should be taken to the appropriate waste collection point for the recycling of electrical and electronic equipment. By ensuring this product is disposed of correctly, you will help prevent potential negative consequences for the environment and human health, which could otherwise be caused by the inappropriate waste handling of this product. For more detailed information about the recycling of this product, please contact your local council, your household waste disposal service, or the shop where you purchased the product.</p>

Please kindly register on our web site www.bertazzoni.com to validate your new product warranty and help us to assist you better in case of any inconvenience.

TWO YEAR LIMITED WARRANTY

The warranties provided by Bertazzoni Spa in this statement apply exclusively to Bertazzoni appliances and accessories sold as new products to the original owner by a Bertazzoni authorized distributor, retailer, dealer or service center and installed in the United States and Canada. The warranties provided in this statement are not transferable and have validity from the date of installation.

COVERAGE INFORMATION

Bertazzoni SpA will repair or replace any component part which fails or proves defective due to materials and/or workmanship within 2 years from the date of installation and under conditions of normal residential use. Repair or replacement will be free of charge, including labor at standard rates and shipping expenses. Repair service must be performed by a Bertazzoni Authorized Service Center during normal working hours.

COSMETIC WARRANTY

Bertazzoni will cover parts showing cosmetic defects in material and workmanship for a period of thirty (30) days from date of installation of the unit. This coverage will include scratches, stains, surface imperfections on stainless steel, paint and porcelain, with the exclusion of slight differences in color due to materials and painting/enamelling technologies.

Exclusions are labor costs, B stock items, out - of - box appliances and display units.

HOW TO OBTAIN SERVICE

To obtain service please contact Bertazzoni Customer Service at the numbers below and make sure to have model number, serial number, and date of purchase ready. This information will be requested by our team and is crucial to speeding up resolution.

UNITED STATES <https://us.bertazzoni.com/more/support>

Phone: 866-905-0010

CANADA <https://ca.bertazzoni.com/more/support>

Phone : 800-361-0799

Save proof of original purchase or of original installation to establish warranty period. Copy of the product serial tag is affixed to the back cover of the instruction manual.

WHAT IS NOT COVERED

1. The product used in any commercial/business application
2. Repair service provided by other than a Bertazzoni authorized service agent.
3. Damage or repair service to correct service provided by an unauthorized agency or the use of unauthorized parts.
4. Installation not in accordance with local electrical codes or plumbing codes.
5. Defects or damage due to improper storage of the product.
6. Defects or damage or missing parts on products sold out of the original factory packaging or from displays.
7. Service calls or repairs to correct the installation of the product and/or related accessories.
8. Service calls to connect, convert or otherwise repair the electrical wiring / gas line / water line to properly use the product.
9. Service calls to provide instructions on the use of a Bertazzoni product.
10. Repair service due to product usage in manner other than what is normal and customary for home use.
11. Replacement of wear and tear parts
12. Replacement of glasses and light bulbs if they are claimed to have failed later than 30 days after installation and in no case later than 4 months after date of purchase
13. Defects and damages arising from accident, alteration, misuse, abuse, improper installation.
14. Defects and damages arising from transportation of the product to the home of the owner.
15. Defects and damage arising from external forces beyond the control of Bertazzoni SpA such as fire, flood, earthquakes and other acts of God.

In case the product will be installed in a remote area, where certified trained technicians are not reasonably available, the customer will be responsible for the transportation costs for the delivery of the product to the nearest authorized service center or for the displacement costs of a certified trained technician.

Bertazzoni does not assume any responsibility for incidental or consequential damages.

Some states do not allow the exclusion or limitation of incidental or consequential damages, so the above limitation or exclusion may not apply to you. This warranty gives you specific legal rights and you may also have other rights which may vary from state to state or province to province.

Technical code: HMVADIU3XE.UA