

# REF30FCIPRL

30" BUILT-IN FREEZER COLUMN  
PANEL READY LEFT SWING DOOR



Conveniently preserve food for an extended time in dry air conditions, avoid freezer burn and frost build-up.

Enjoy ample and flexible food storage thanks to Bertazzoni's columns design featuring the most usable interior depth in the category.

Serve premium ice and choose the actual ice cube size with the digitally-controlled and filtered automatic ice maker

Access all temperature settings through the intuitive digital touch-control interface, with fast-freeze and bottle chill options.

Maintain the correct temperature in the freezer when opening the door for reloading, thanks to the unique lateral side-to-side airflow circulation.

Create a truly flush front alignment with the adjacent cabinets and minimal clearance with the exclusive "lift & swing" door hinge.

Customize virtually any column combination suited for your kitchen layout. Single, double, triple and more configurations are possible.

Create a harmonized look throughout the kitchen selecting the handle style that matches your complete Bertazzoni appliances suite. Panel ready models provide the option to mount your own cabinet hardware.

Designed and manufactured with pride in Italy.

Have peace of mind with a standard full 2 years parts & labor warranty and 5 years warranty for the entire sealed system.

## PRODUCT FEATURES

Size	H: 84" W: 30" D: 24 1/4"
Refrigerator type	Built-in freezer column
Door finish	Panel ready
Interior finish	White aluminum
User interface	Digital touch control interface inside
Lighting	LED lights interior illumination
Shelves	2
Drawer freezer	3
Door storage	2
Ice maker	Automatic ice maker
Ice production capacity	2.2 lbs/ 24 hrs
Modes	Shopping, Vacation, Bottle cooler, Ice maker, Water filter, Super ice, Sabbath mode
Open door alarm	Yes
Included accessories	Ice tray

## INTERIOR CAPACITY

Total volume	16.84 cu.ft
--------------	-------------

## TECHNICAL SPECIFICATIONS

Electrical supply	115 V 60 HZ - 327 W 3 Amp
Power connection	NEMA 5-15P with 79" power cord
DOE Compliant	Yes
Energy consumption	598.0 kWh/yr
Water connection	Rear of product
Water filter	Yes - external
Water supply pressure	Min 0.05 MPa (0.5Bar) Max 0.5 MPa (5Bar)
Certification	cUL
Warranty	2 years parts & labor Sealed system: 5 years labor
Packaging dimensions and weight	W 31 8/16" H 89" D 31 2/16" 396.83 lbs

## OPTIONAL ACCESSORIES

901560	42" Bridge toekick
Z330001	Replacement water filter accessory
901561	48" Bridge toekick
HERHKCOL	Handle kit for columns Heritage
MASHKCOL	Handle kit for columns Master
PROHKCOL	Handle kit for columns Professional

# REF30FCIPRL

30" BUILT-IN FREEZER COLUMN  
PANEL READY LEFT SWING DOOR



## PRODUCT DIMENSIONS

SIDE VIEW

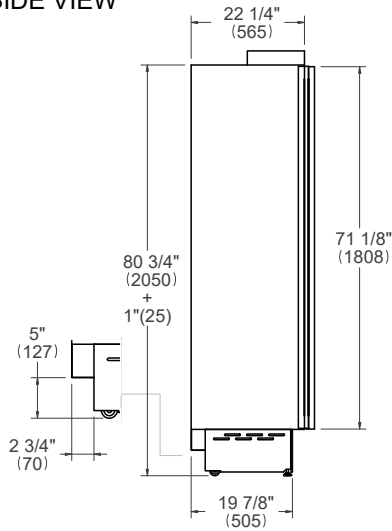

FRONT VIEW

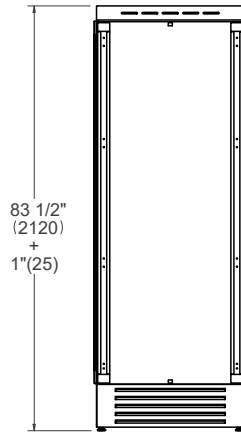

TOP VIEW

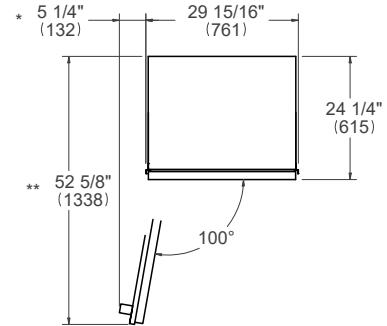

\* Maximum Overall Handle Dimension  
\*\* Width of 3/4" (19mm) Door Panel

## ELECTRICAL & WATER CONNECTION

TOP VIEW

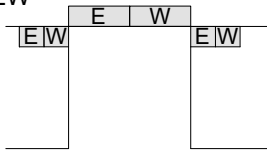

FRONT VIEW

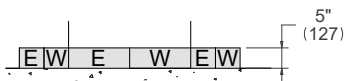

**E** A properly-grounded, horizontally-mounted electrical receptacle should be installed according to this drawing.

**W** To connect to the water supply system, a 3/4" NPT waterline with accessible shut-off valve must be supplied.

Connection(s) placement within the opening may require additional cabinet depth.

## INSTALLATION REQUIREMENTS

If the appliance(s) is not connected through the side profile trims to secured cabinetry anti-tip brackets must be installed.

## CUTOUT DIMENSIONS

TOP VIEW

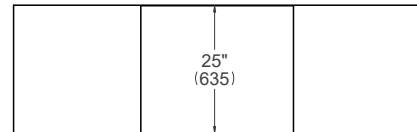

SIDE VIEW

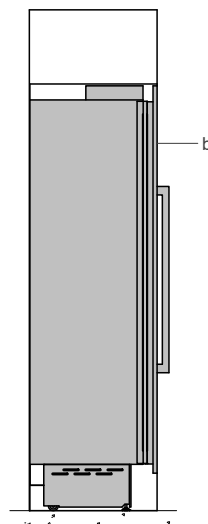

FRONT VIEW

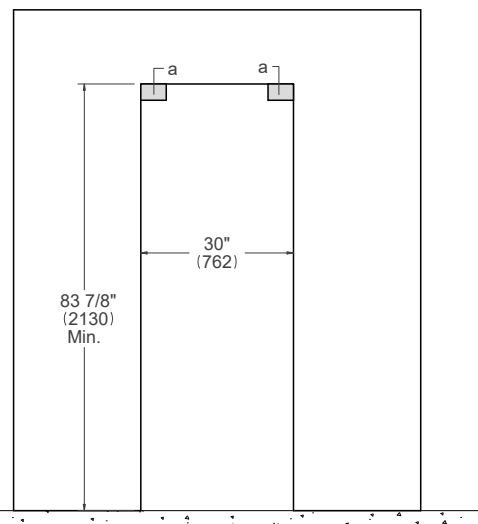

- (a) Area to be left clear for the anti-tipping brackets – 3"1/2x5" (82x127mm)
- (b) Panel dimensions available on Built-in Food Preservation Design Guide or Installation Manual

For installation of multiple products in combination, refer to the Built-in Food Preservation Design Guide at [us.bertazzoni.com](http://us.bertazzoni.com) or [ca.bertazzoni.com](http://ca.bertazzoni.com)

**Disclaimer:** while every effort has been made to ensure the accuracy of the information contained in this document, Fratelli Bertazzoni reserves the right to change it at any time without notice. For detailed installation instructions, consult the installation manual. Fratelli Bertazzoni, Bertazzoni and the winged wheel brand icon are registered trademarks of Bertazzoni Spa.