WALL OVENS
SPECIALTY OVENS
GAS RANGETOPS & COOKTOPS
INDUCTION & ELECTRIC COOKTOPS

DESIGN GUIDE



BUILT-IN COOKING DESIGN GUIDE

Bertazzoni appliances are designed to work together and create harmony in the kitchen.

The products in our built-in cooking program can be combined with numerous installation options to create the ideal setup that suits the kitchen layout and cooking style of the homeowner.

Versatility is key, with a choice of technologies and designs that work together seamlessly.

This guide contains up-to-date technical specifications and dimensions necessary to prepare the installation of Bertazzoni built-in cooking products in a kitchen.

All these details are also available online at bertazzoni.com.

INDEX



INTRODUCTION	3	INDUCTION & ELECTRIC COOKTOPS	72
WALL OVENS	4	36" Induction Cooktop	74
30" Electric Convection Single Ovens	6	30" Induction Cooktop	77
30" Electric Convection Double Ovens	11	30" Electric Ceramic Cooktop	80
24" Electric Convection Oven	15	24" Electric Ceramic Cooktop	83
SPECIALTY OVENS	19	MULTIPLE INSTALLATIONS	86
30" Convection Speed Ovens	21	30" Oven - Wall Configurations	88
30" Convection Steam Ovens	26	24" Oven - Wall Configurations	100
30" Warming Drawer	31	30" Oven and Cooktop - Undercounter Configurations	104
30" Microwave Oven	34	24" Oven and Cooktop - Undercounter Configurations	123
24" Convection Speed Ovens	38		
24" Microwave Drawer	43		
GAS RANGETOPS & COOKTOPS	46		
48" Rangetops	48		
36" Rangetops	51		
36" Drop-in Cooktops 6 burners	54		
36" Drop-in Cooktops 5 burners	57		
30" Drop-in Cooktops	60		
36" Gas Cooktop Front Control	63		
30" Gas Cooktop Front Control	66		
24" Gas Cooktop Front Control	69		

WALL OVENS



Built-in ovens offer an excellent alternative – or even complementary choice – to freestanding range, offering simple elegance. For some, the ability to fit an oven easily into a compact space makes built-in ovens their first choice. For others it is the attraction of flexible design with the option to install the ovens on top of each other or side-by-side, at eye-level or undercounter.

All Bertazzoni built-in ovens can be installed proud or perfectly flush to align with matching convection steam, speed and microwave ovens as well as warming drawers.

30" Electric Convection
Single Ovens

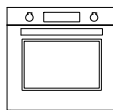

24" Electric Convection
Single Ovens



30" Electric Convection
Double Ovens

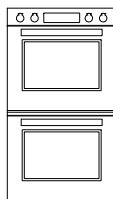



30" Electric Convection Single Ovens

Dimensions



PROF30FSEXT
 PROF30FSEXV

MAST30FSEXT
 MAST30FSEXV

SIDE VIEW

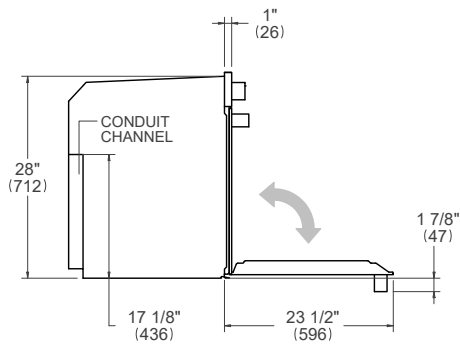

FRONT VIEW

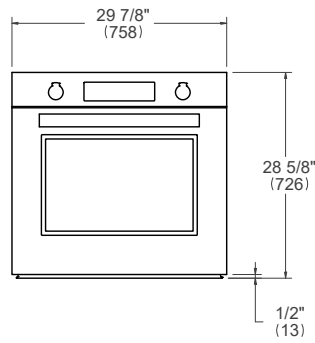

TOP VIEW

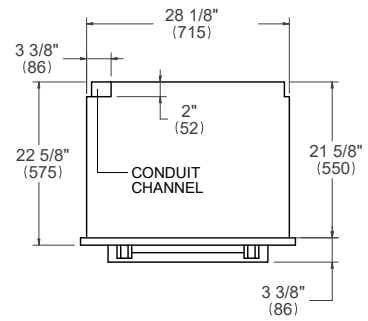

30" Electric Convection Single Ovens

Installation requirements



INSTALLATION

The oven can be installed in a proud or flush application. Finish the edges of the opening because they may be visible when the door is open.

The clearance between the oven and the kitchen units or other installed appliances must be enough to ensure sufficient cooling air ventilation.

For instructions and clearance of product combinations please see the Multiple Installation Sections (page 86).

CABINET REQUIREMENT

To prevent possible damage to cabinets and cabinet finishes, use only materials and finishes that will not discolor or delaminate and will withstand temperatures up to 195°F (90°C).

Installation of the appliance must be performed in accordance with the provisions of applicable legislation.

BE SURE that support for this appliance is perpendicular to the front facing of the wall or cabinet before you perform the installation.

The cabinet base must be flat and capable of supporting the weight of the oven when in use.

Minimum Suggested Load on Cabinet Base Board	275lb (125kg)
---	---------------

ELECTRICAL REQUIREMENT

The installation must comply with all applicable electrical codes.

A properly-grounded horizontally- mounted electrical receptacle should be installed.

Place the electrical supply flush with the back wall and within the shaded area shown in the illustrations.

Placement within the opening may require additional cabinet depth.

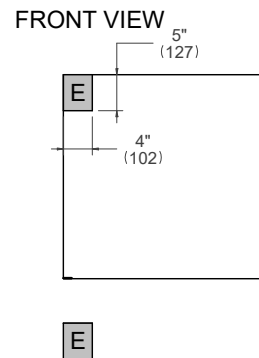

A separate circuit and a circuit breaker servicing only this appliance is recommended

Electrical supply	120/240 V 60 Hz 5500 W
	120/208 V 60 Hz 4400 W
Service	30 Amp dedicated circuit
Power Connection	METAL CONDUIT – 59" cord

For detailed installation specifications consult the installation manual.

30" Electric Convection Single Ovens

Proud installation



TOP VIEW

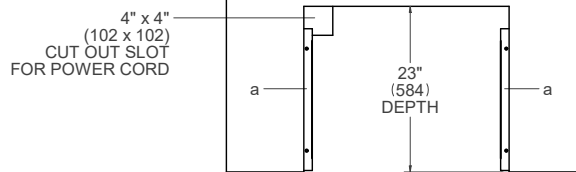

SIDE VIEW

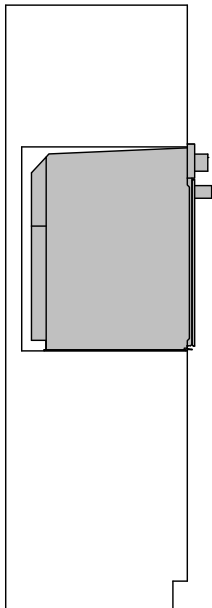

FRONT VIEW

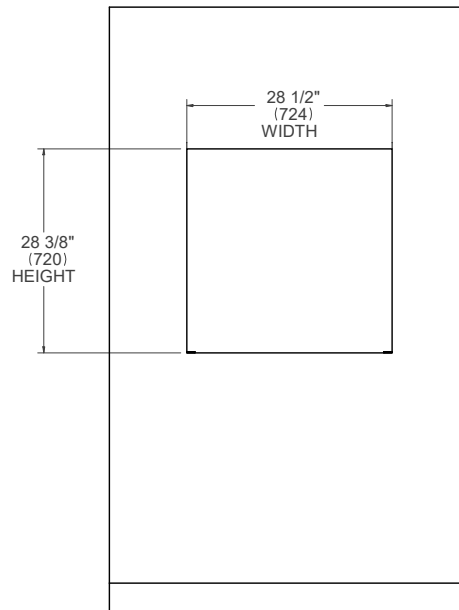

(a) Spacers - Included with appliance

30" Electric Convection Single Ovens

Flush installation non vented



TOP VIEW

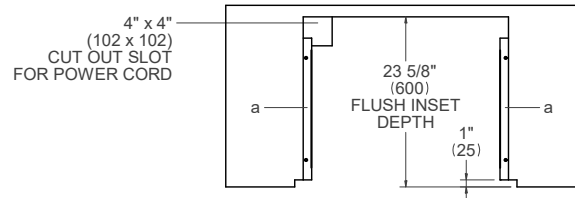

SIDE VIEW

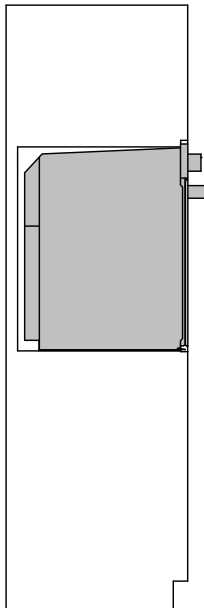

FRONT VIEW

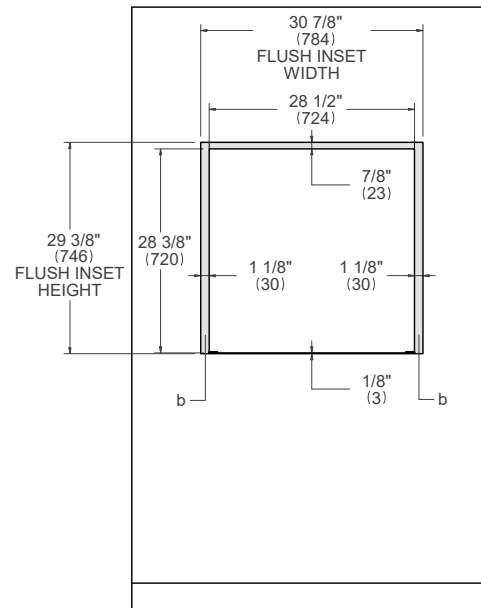

- (a) Spacers - Included with appliance
- (b) Visible Area - Match finish to outside cabinet panels

30" Electric Convection Single Ovens

Flush installation vented



TOP VIEW

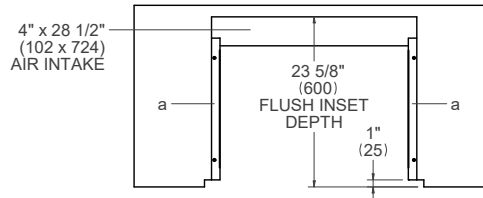

SIDE VIEW

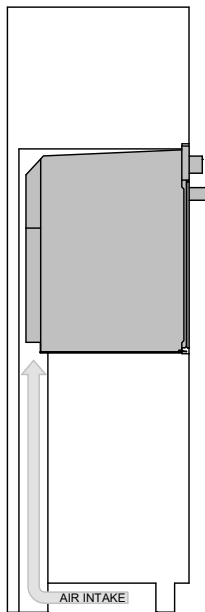

FRONT VIEW

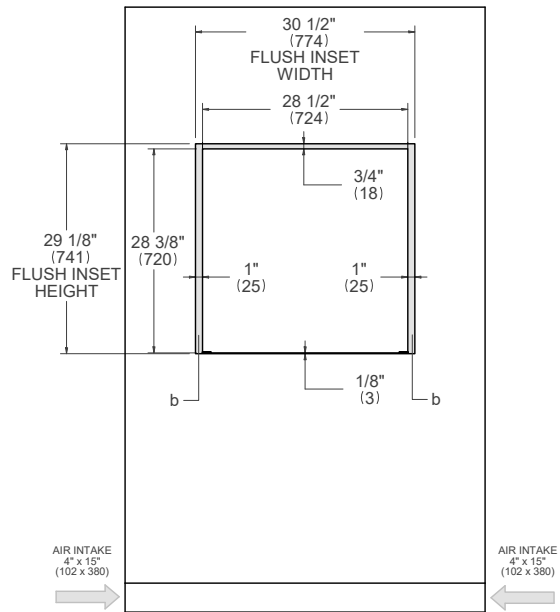

- (a) Spacers - Included with appliance
- (b) Visible Area - Match finish to outside cabinet panels

30" Electric Convection Double Ovens

Dimensions



PROF30FDEXT
 PROF30FDEXV

MAST30FDEXT
 MAST30FDEXV

SIDE VIEW

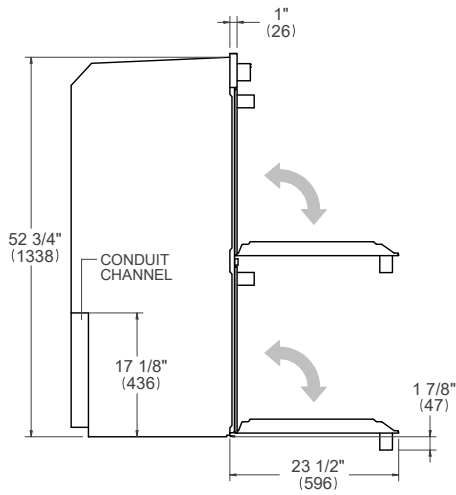

FRONT VIEW

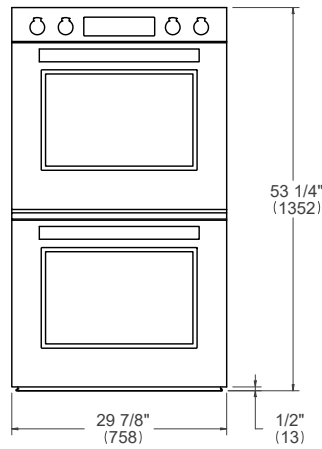

TOP VIEW

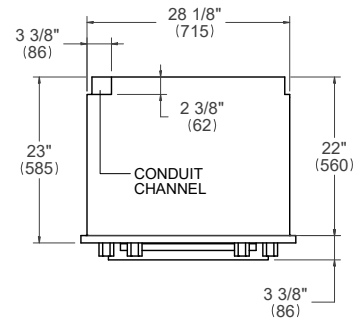

30" Electric Convection Double Ovens

Installation requirements



INSTALLATION

The oven can be installed in a proud or flush application. Finish the edges of the opening because they may be visible when the door is open.

The clearance between the oven and the kitchen units or other installed appliances must be enough to ensure sufficient cooling air ventilation.

For instructions and clearance of product combinations please see the Multiple Installation Sections (page 86).

CABINET REQUIREMENT

To prevent possible damage to cabinets and cabinet finishes, use only materials and finishes that will not discolor or delaminate and will withstand temperatures up to 195°F (90°C). Installation of the appliance must be performed in accordance with the provisions of applicable legislation. BE SURE that support for this appliance is perpendicular to the front facing of the wall or cabinet before you perform the installation.

The cabinet base must be flat and capable of supporting the weight of the oven when in use.

Minimum Suggested Load on Cabinet Base Board	485lb (220kg)
---	---------------

ELECTRICAL REQUIREMENT

The installation must comply with all applicable electrical codes. A properly-grounded horizontally- mounted electrical receptacle should be installed. Place the electrical supply flush with the back wall and within the shaded area shown in the illustrations. Placement within the opening may require additional cabinet depth.

FRONT VIEW

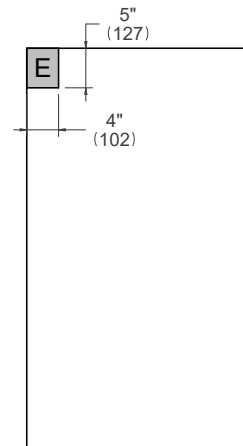

A separate circuit and a circuit breaker servicing only this appliance is recommended.

Electrical supply	120/240 V 60 Hz 1 1000 W
	120/208 V 60 Hz 8800 W
Service	50 Amp dedicated circuit
Power Connection	METAL CONDUIT – 59" cord

For detailed installation specifications consult the installation manual.

30" Electric Convection Double Ovens

Proud installation



TOP VIEW

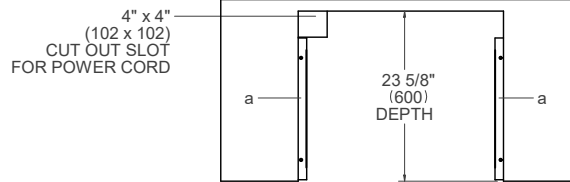

SIDE VIEW

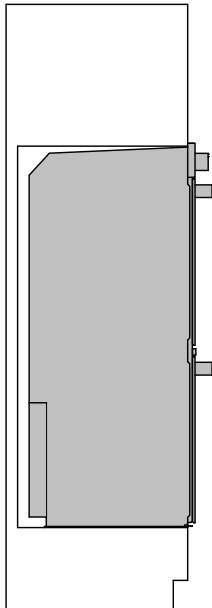

FRONT VIEW

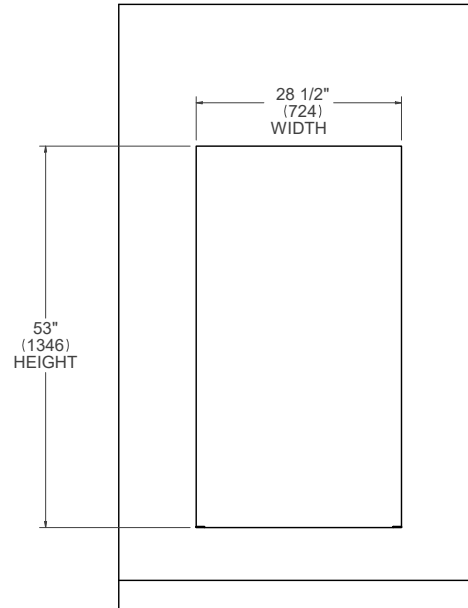

(a) Spacers - Included with appliance

30" Electric Convection Double Ovens

Flush installation vented



TOP VIEW

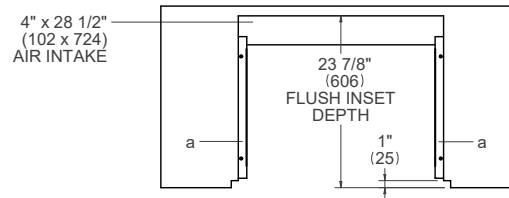

SIDE VIEW

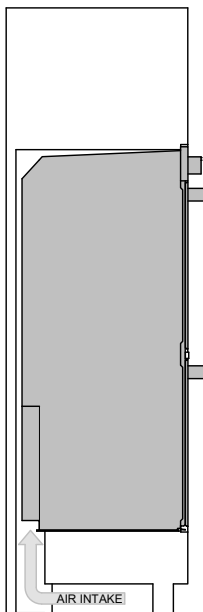

FRONT VIEW

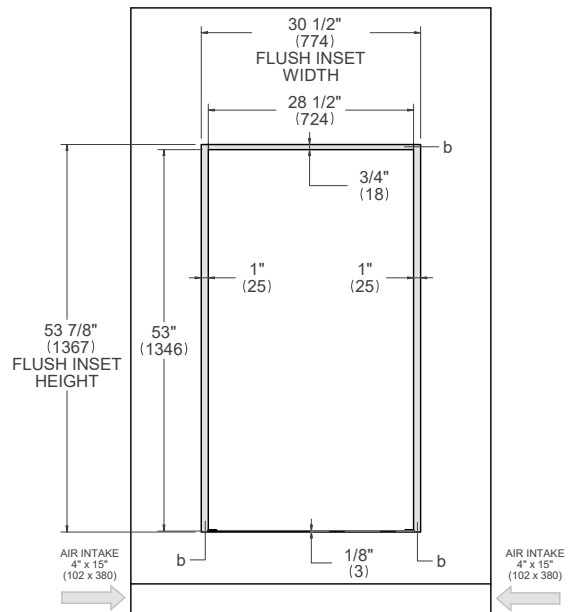

- (a) Spacers - Included with appliance
- (b) Visible Area - Match finish to outside cabinet panels

24" Electric Convection Single Ovens

Dimensions



PROF24FSEXV

SIDE VIEW

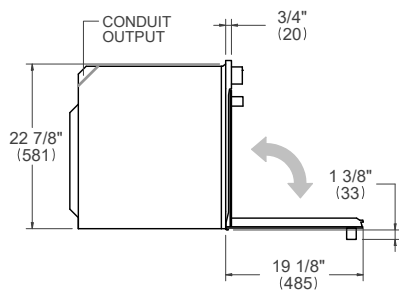

FRONT VIEW

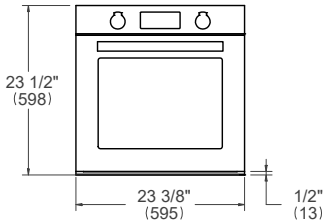

TOP VIEW

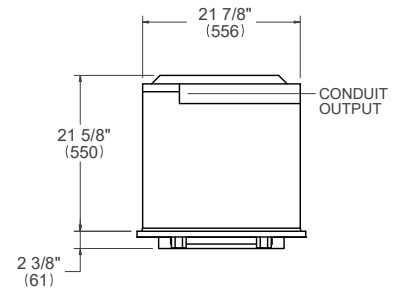

24" Electric Convection Single Ovens

Installation requirements



INSTALLATION

The oven can be installed in a proud or flush application. Finish the edges of the opening because they may be visible when the door is open.

The clearance between the oven and the kitchen units or other installed appliances must be enough to ensure sufficient cooling air ventilation.

For instructions and clearance of product combinations please see the Multiple Installation Sections (page 86).

CABINET REQUIREMENT

To prevent possible damage to cabinets and cabinet finishes, use only materials and finishes that will not discolor or delaminate and will withstand temperatures up to 195°F (90°C). Installation of the appliance must be performed in accordance with the provisions of applicable legislation. BE SURE that support for this appliance is perpendicular to the front facing of the wall or cabinet before you perform the installation.

The cabinet base must be flat and capable of supporting the weight of the oven when in use.

Minimum Suggested Load on Cabinet Base Board	155lb (70kg)
---	--------------

ELECTRICAL REQUIREMENT

The installation must comply with all applicable electrical codes.

A properly-grounded horizontally- mounted electrical receptacle should be installed.

Place the electrical supply flush with the back wall and within the shaded area shown in the illustrations. Placement within the opening may require additional cabinet depth.

FRONT VIEW

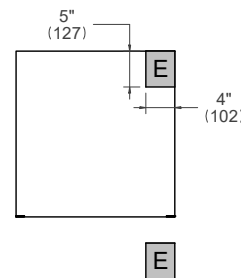

A separate circuit and a circuit breaker servicing only this appliance is recommended

Electrical supply	120/240 V 60 Hz 2800 W 120/208 V 60 Hz 2100 W
Service	16 Amp dedicated circuit
Power Connection	METAL CONDUIT – 59" cord

For detailed installation specifications consult the installation manual.

24" Electric Convection Single Ovens

Proud installation



TOP VIEW

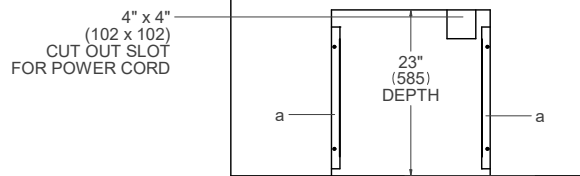

SIDE VIEW

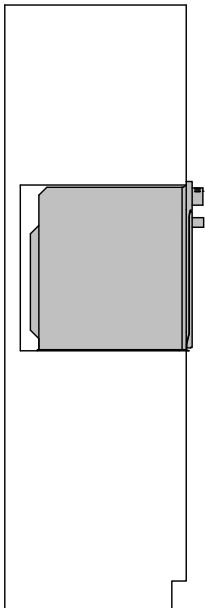

FRONT VIEW

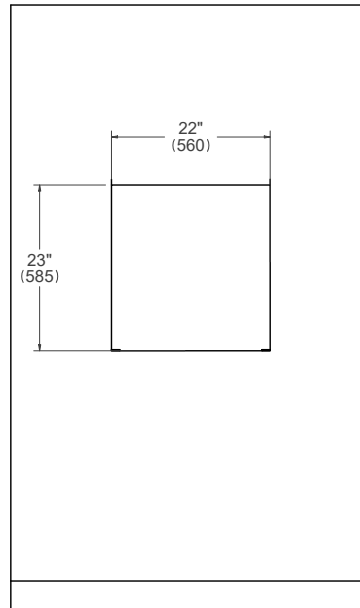

(a) Spacers - Included with appliance

24" Electric Convection Single Ovens

Flush installation non vented



TOP VIEW

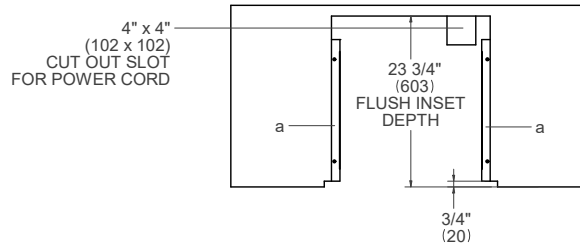

SIDE VIEW

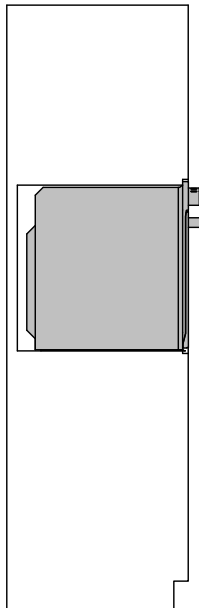

FRONT VIEW

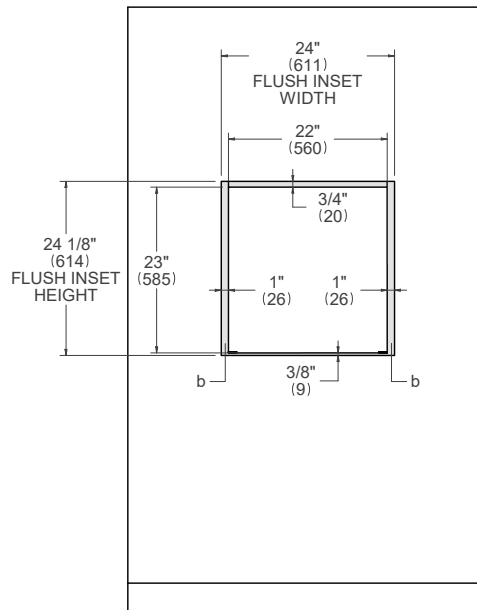

- (a) Spacers - Included with appliance
- (b) Visible Area - Match finish to outside cabinet panels

SPECIALTY OVENS



Bertazzoni has perfected cooking appliances for over 100 years. As a result, we understand that today's home chefs want a variety of technologies at their disposal. That means lifestyle-driven speed cooking without sacrificing flavor, texture or aroma. Or cooking with steam to retain the food's natural nutrients, vitamins and minerals. Bertazzoni built-in specialty ovens include convection, steam, speed and powerful microwave technology, along with a practical warming drawer. Engineered to integrate perfectly into the vertical and horizontal lines of your kitchen cabinets, they can be installed stacked or side by side to create perfect symmetry.

30" Convection
Speed Ovens

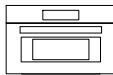

30" Microwave Oven



30" Convection
Steam Ovens

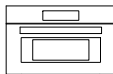

24" Convection
Speed Oven



30" Warming Drawers



24" Microwave Drawer



Control panel with buttons: TIMER, VEG, FISH, MEAT, REHEAT, COOK BROS, BROIL, COMI, COOK STEAM, STEAM, - +, WATER, RECALL, 11:50, TIME, STOP, 3 SEC.



30" Convection Speed Ovens

Dimensions



PROF30SOEX
MAST30SOEX

SIDE VIEW

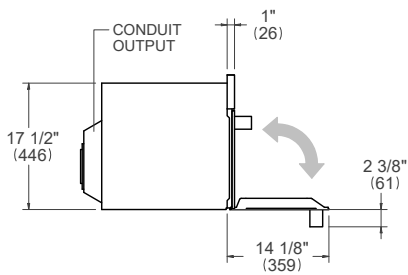

FRONT VIEW

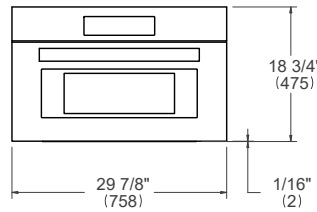

TOP VIEW

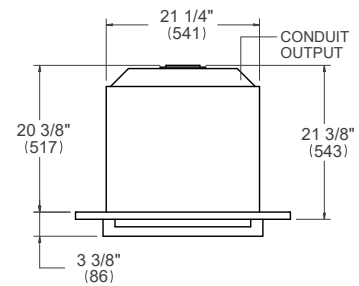

30" Convection Speed Ovens

Installation requirements



INSTALLATION

The oven can be installed in a proud or flush application. Finish the edges of the opening because they may be visible when the door is open.

The clearance between the oven and the kitchen units or other installed appliances must be enough to ensure sufficient cooling air ventilation.

For instructions and clearance of product combinations please see the Multiple Installation Sections (page 86).

CABINET REQUIREMENT

To prevent possible damage to cabinets and cabinet finishes, use only materials and finishes that will not discolor or delaminate and will withstand temperatures up to 195°F (90°C). Installation of the appliance must be performed in accordance with the provisions of applicable legislation.

BE SURE that support for this appliance is perpendicular to the front facing of the wall or cabinet before you perform the installation.

The cabinet base must be flat and capable of supporting the weight of the oven when in use.

Minimum Suggested Load on Cabinet Base Board	110lb (50kg)
---	--------------

ELECTRICAL REQUIREMENT

The installation must comply with all applicable electrical codes.

A properly-grounded horizontally- mounted electrical receptacle should be installed.

Place the electrical supply flush with the back wall and within the shaded area shown in the illustrations. Placement within the opening may require additional cabinet depth.

FRONT VIEW

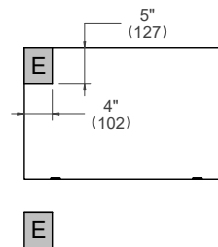

A separate circuit and a circuit breaker servicing only this appliance is recommended.

Electrical supply	120/240 V 60 Hz 3850 W
Service	16 Amp dedicated circuit
Power Connection	METAL CONDUIT – 59" cord

For detailed installation specifications consult the installation manual.

30" Convection Speed Ovens

Proud installation



TOP VIEW

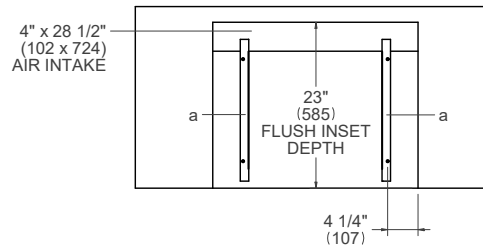

SIDE VIEW

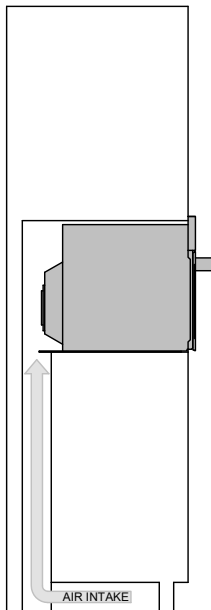

FRONT VIEW

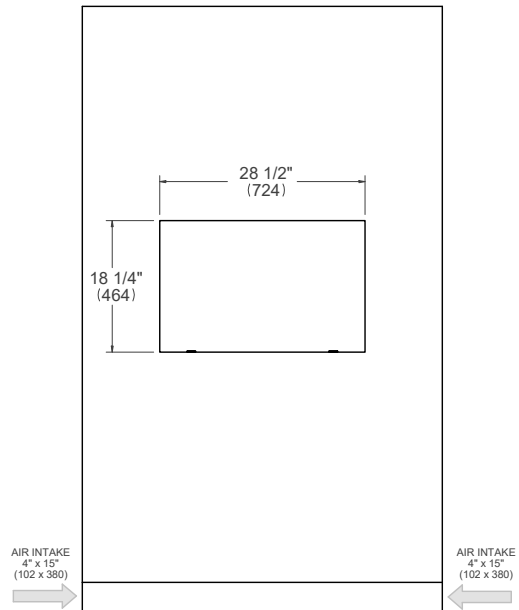

(a) Spacers - Included with appliance

30" Convection Speed Ovens

Flush installation



TOP VIEW

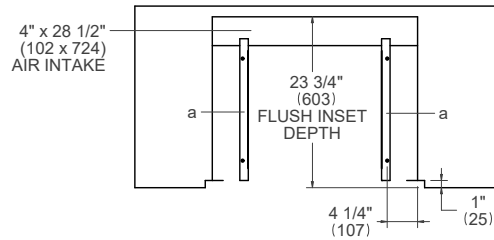

SIDE VIEW

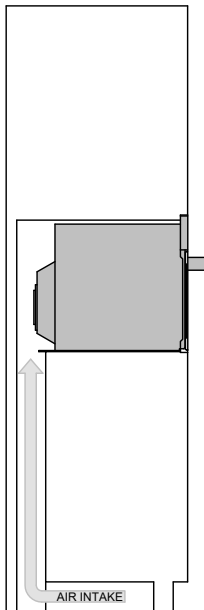

FRONT VIEW

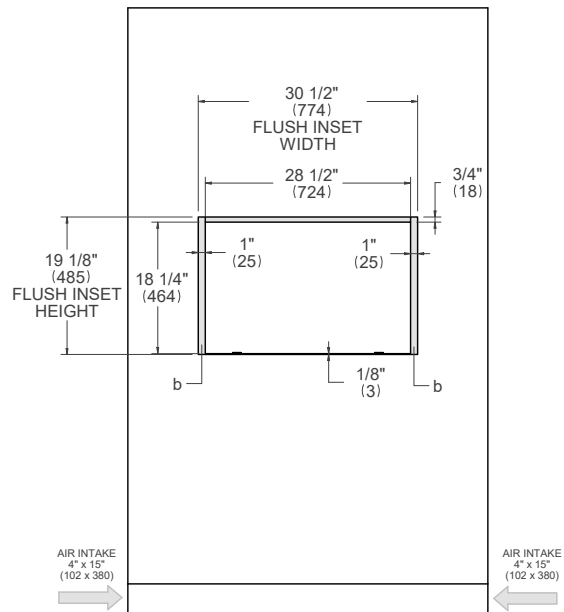

- (a) Spacers - Included with appliance
- (b) Visible Area - Match finish to outside cabinet panels

30" Convection Speed Ovens

Undercounter installation



TOP VIEW

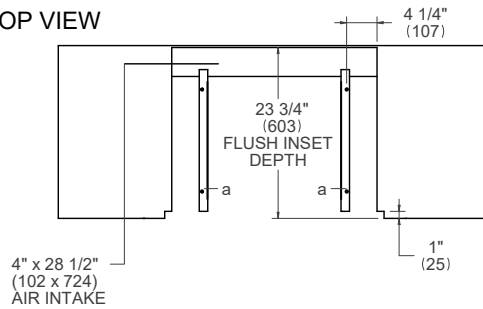

SIDE VIEW

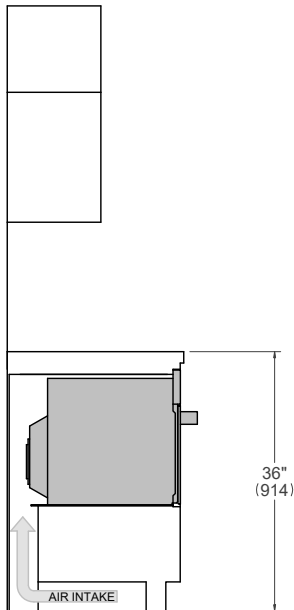

FRONT VIEW

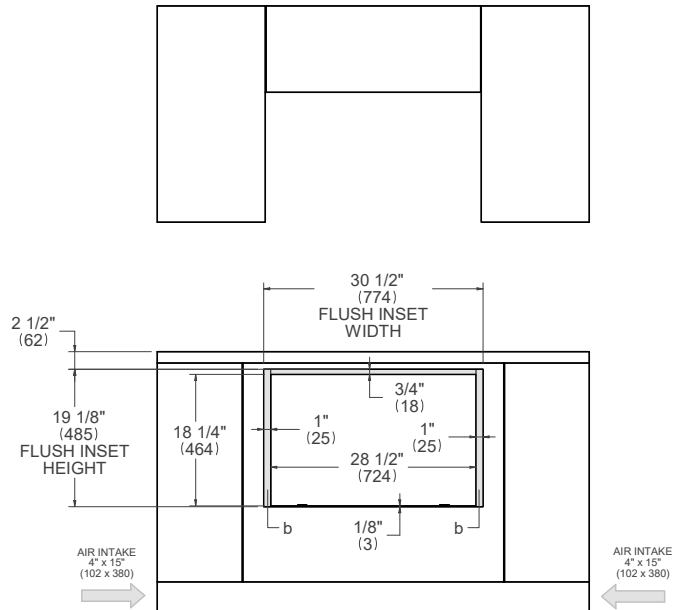

- (a) Spacers - Included with appliance
- (b) Visible Area - Match finish to outside cabinet panels

30" Convection Steam Ovens

Dimensions



PROF30CSEX
MAST30CSEX

SIDE VIEW

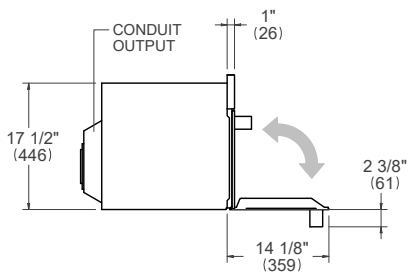

FRONT VIEW

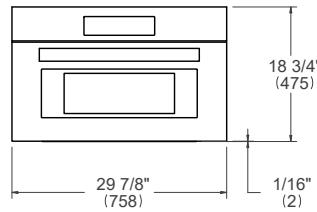

TOP VIEW

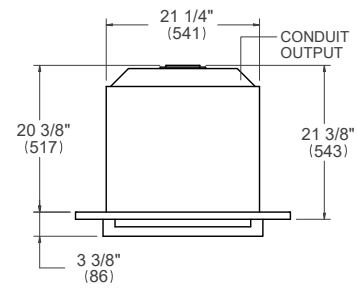

30" Convection Steam Ovens

Installation requirements



INSTALLATION

The oven can be installed in a proud or flush application. Finish the edges of the opening because they may be visible when the door is open.

The clearance between the oven and the kitchen units or other installed appliances must be enough to ensure sufficient cooling air ventilation.

For instructions and clearance of product combinations please see the Multiple Installation Sections (page 86).

CABINET REQUIREMENT

To prevent possible damage to cabinets and cabinet finishes, use only materials and finishes that will not discolor or delaminate and will withstand temperatures up to 195°F (90°C). Installation of the appliance must be performed in accordance with the provisions of applicable legislation.

BE SURE that support for this appliance is perpendicular to the front facing of the wall or cabinet before you perform the installation.

The cabinet base must be flat and capable of supporting the weight of the oven when in use.

Minimum Suggested Load on Cabinet Base Board	110lb (50kg)
---	--------------

ELECTRICAL REQUIREMENT

The installation must comply with all applicable electrical codes.

A properly-grounded horizontally- mounted electrical receptacle should be installed.

Place the electrical supply flush with the back wall and within the shaded area shown in the illustrations. Placement within the opening may require additional cabinet depth.

FRONT VIEW

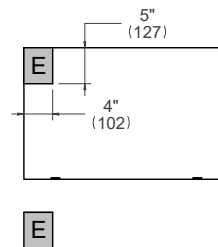

A separate circuit and a circuit breaker servicing only this appliance is recommended

Electrical supply	120/240 V 60 Hz 3200 W
Service	16 Amp dedicated circuit
Power Connection	METAL CONDUIT – 59" cord

For detailed installation specifications consult the installation manual.

30" Convection Steam Ovens

Proud installation



TOP VIEW

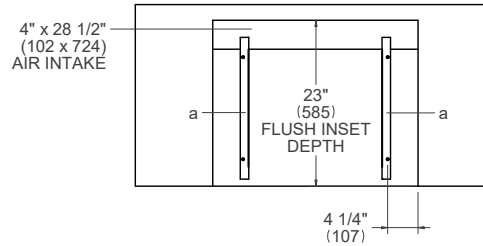

SIDE VIEW

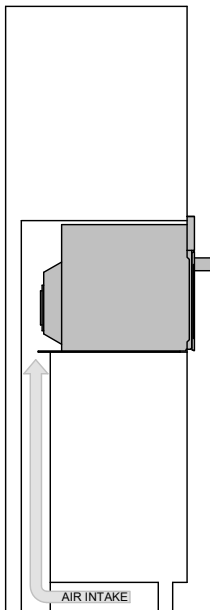

FRONT VIEW

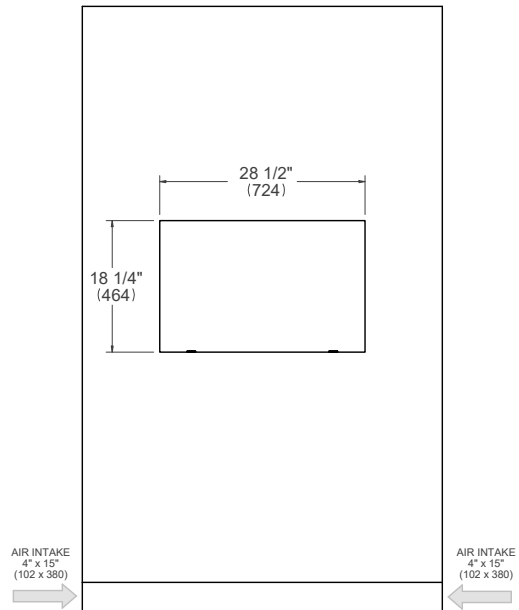

(a) Spacers - Included with appliance

30" Convection Steam Ovens

Flush installation



TOP VIEW

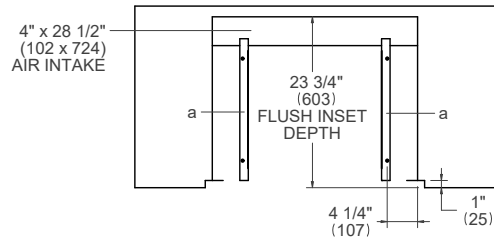

SIDE VIEW

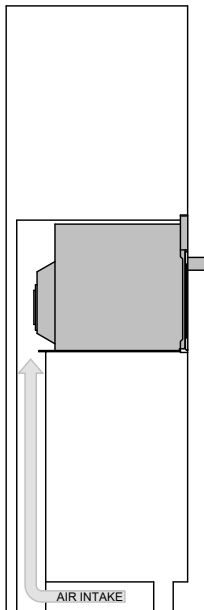

FRONT VIEW

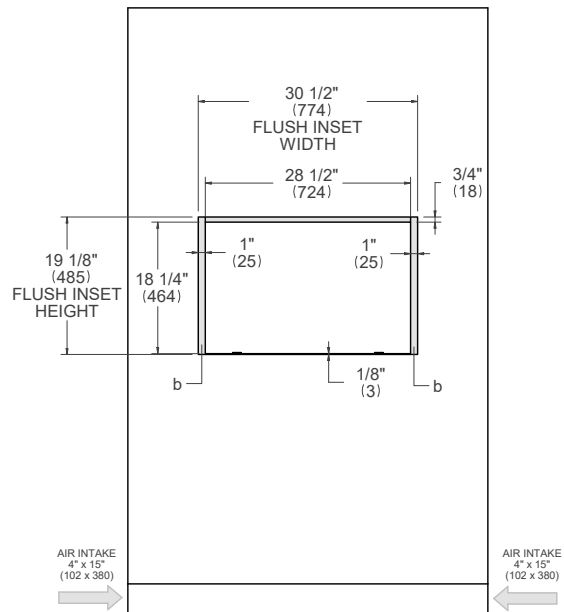

- (a) Spacers - Included with appliance
- (b) Visible Area - Match finish to outside cabinet panels

30" Convection Steam Ovens

Undercounter installation

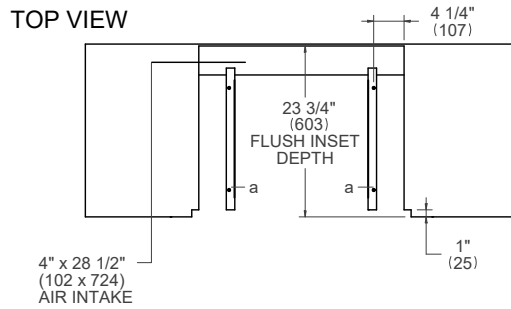

SIDE VIEW

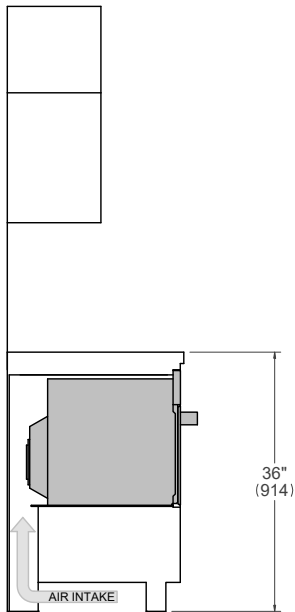

FRONT VIEW

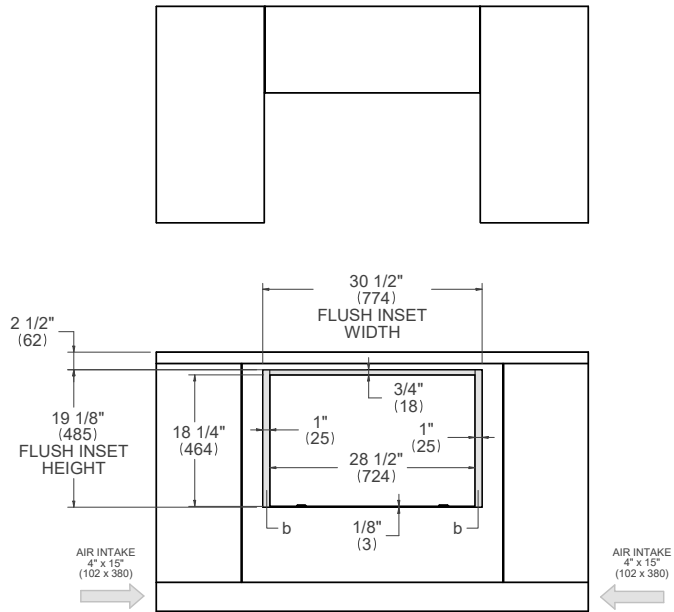

Accessories – Included with appliance
 Visible Area – Match finish to outside cabinet panels

30" Warming Drawers

Dimensions



PROF30WDEX
MAST30WDEX

SIDE VIEW

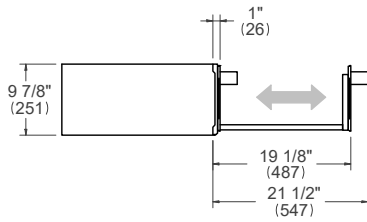

FRONT VIEW

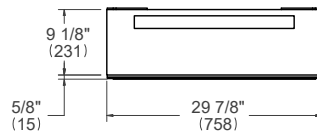

TOP VIEW

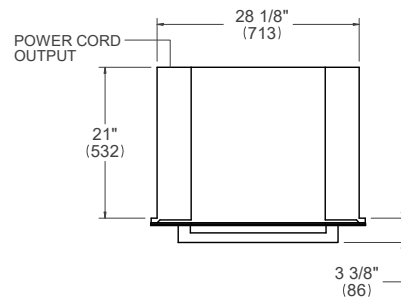

30" Warming Drawer

Installation requirements



INSTALLATION

The oven can be installed in a proud or flush application. Finish the edges of the opening because they may be visible when the door is open.

The clearance between the oven and the kitchen units or other installed appliances must be enough to ensure sufficient cooling air ventilation.

For instructions and clearance of product combinations please see the Multiple Installation Sections (page 86).

CABINET REQUIREMENT

To prevent possible damage to cabinets and cabinet finishes, use only materials and finishes that will not discolor or delaminate and will withstand temperatures up to 195°F (90°C). Installation of the appliance must be performed in accordance with the provisions of applicable legislation.

BE SURE that support for this appliance is perpendicular to the front facing of the wall or cabinet before you perform the installation.

The cabinet base must be flat and capable of supporting the weight of the oven when in use.

Minimum Suggested Load on Cabinet Base Board	110lb (50kg)
---	--------------

ELECTRICAL REQUIREMENT

The installation must comply with all applicable electrical codes.

A properly-grounded horizontally- mounted electrical receptacle should be installed.

Place the electrical supply flush with the back wall and within the shaded area shown in the illustrations. Placement within the opening may require additional cabinet depth.

FRONT VIEW

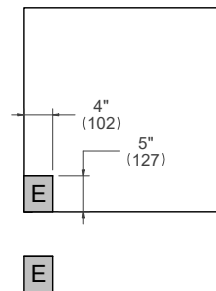

Electrical supply	120 V	60 Hz	550 W
Service	5 Amp		
Power Connection	NEMA 5-15P		

For detailed installation specifications consult the installation manual.

30" Warming Drawer

Flush installation

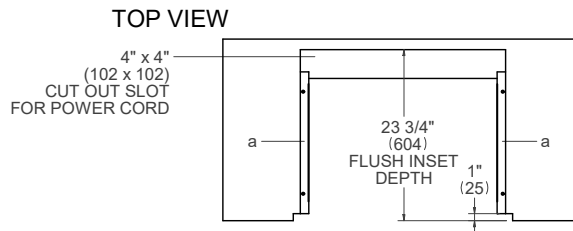

SIDE VIEW

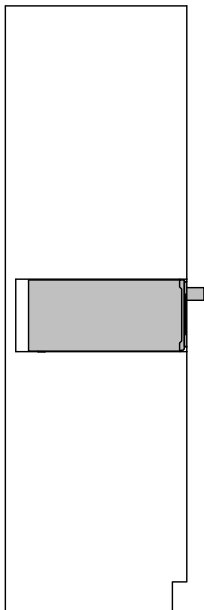

FRONT VIEW

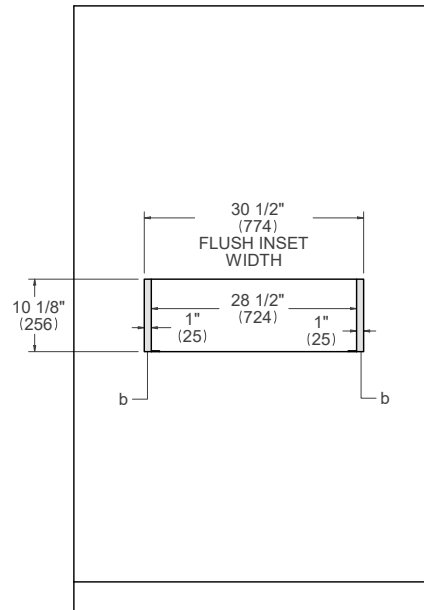

-
- (a) Spacers - Included with appliance
 - (b) Visible Area - Match finish to outside cabinet panels

30" Microwave Oven

Dimensions



MO30STANE with frame FR30PROX

SIDE VIEW

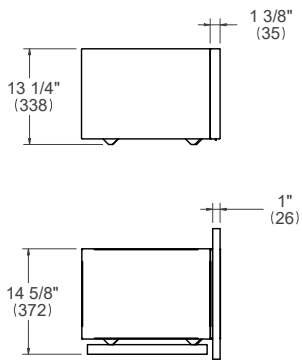

FRONT VIEW

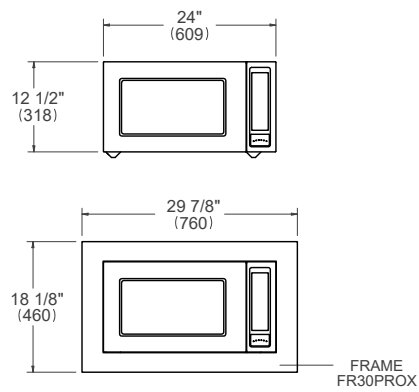

TOP VIEW

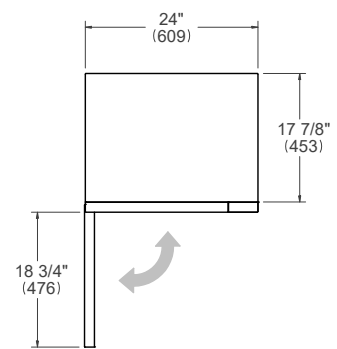

30" Microwave Oven

Installation requirements



INSTALLATION

The oven can be installed in a proud or flush application. Finish the edges of the opening because they may be visible when the door is open.

The clearance between the oven and the kitchen units or other installed appliances must be enough to ensure sufficient cooling air ventilation.

For instructions and clearance of product combinations please see the Multiple Installation Sections (page 86).

CABINET REQUIREMENT

To prevent possible damage to cabinets and cabinet finishes, use only materials and finishes that will not discolor or delaminate and will withstand temperatures up to 195°F (90°C). Installation of the appliance must be performed in accordance with the provisions of applicable legislation.

BE SURE that support for this appliance is perpendicular to the front facing of the wall or cabinet before you perform the installation.

The cabinet base must be flat and capable of supporting the weight of the oven when in use.

Minimum Suggested Load on Cabinet Base Board	110lb (50kg)
---	--------------

ELECTRICAL REQUIREMENT

The installation must comply with all applicable electrical codes.

A properly-grounded horizontally- mounted electrical receptacle should be installed.

Place the electrical supply flush with the back wall and within the shaded area shown in the illustrations.

Placement within the opening may require additional cabinet depth.

FRONT VIEW

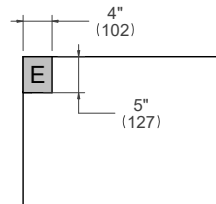

A separate circuit and a circuit breaker servicing only this appliance is recommended.

Electrical supply	120 V	60 Hz	1100 W
Service	10 Amp dedicated circuit		
Power Connection	NEMA 5-15P plug with 59" cord		

For detailed installation specifications consult the installation manual.

30" Microwave Oven

Proud installation



TOP VIEW

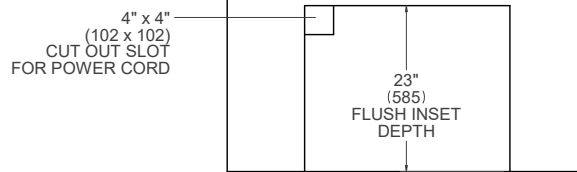

SIDE VIEW

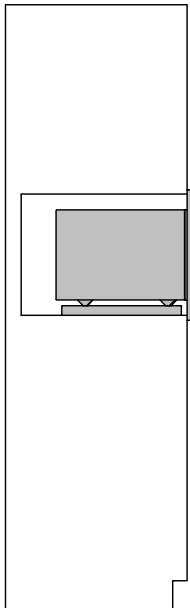

FRONT VIEW

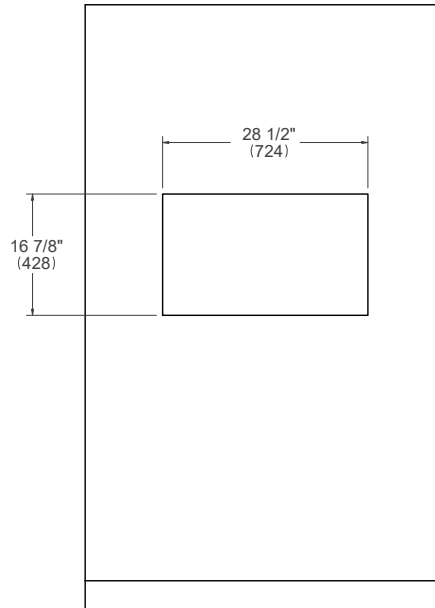

30" Microwave Oven

Flush installation



TOP VIEW

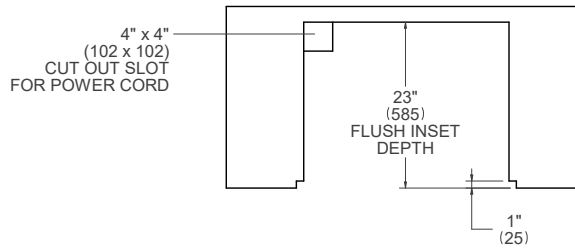

SIDE VIEW

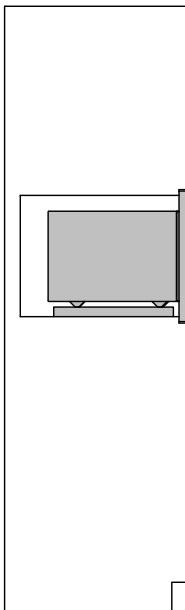

FRONT VIEW

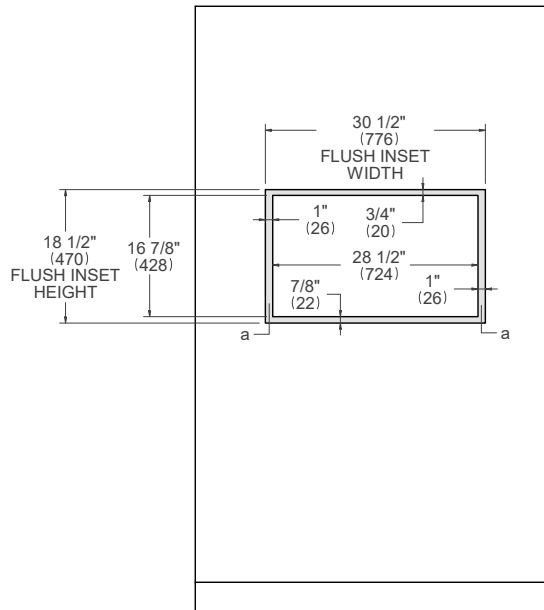

(a) Visible Area - Match finish to outside cabinet panels

24" Convection Speed Ovens

Dimensions



PROF24SOEX

SIDE VIEW

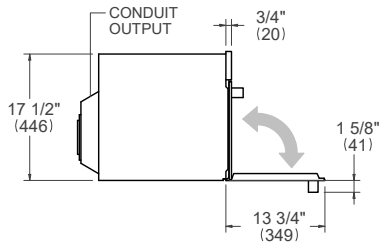

FRONT VIEW

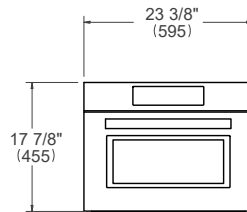

TOP VIEW

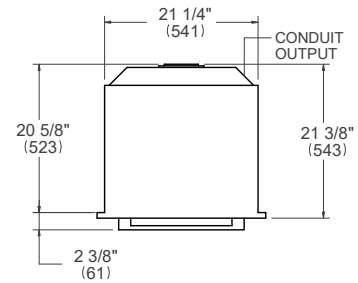

24" Convection Speed Ovens

Installation requirements



INSTALLATION

The oven can be installed in a proud or flush application. Finish the edges of the opening because they may be visible when the door is open.

The clearance between the oven and the kitchen units or other installed appliances must be enough to ensure sufficient cooling air ventilation.

For instructions and clearance of product combinations please see the Multiple Installation Sections (page 86).

CABINET REQUIREMENT

To prevent possible damage to cabinets and cabinet finishes, use only materials and finishes that will not discolor or delaminate and will withstand temperatures up to 195°F (90°C). Installation of the appliance must be performed in accordance with the provisions of applicable legislation.

BE SURE that support for this appliance is perpendicular to the front facing of the wall or cabinet before you perform the installation.

The cabinet base must be flat and capable of supporting the weight of the oven when in use.

Minimum Suggested Load on Cabinet Base Board	110lb (50kg)
---	--------------

ELECTRICAL REQUIREMENT

The installation must comply with all applicable electrical codes.

A properly-grounded horizontally- mounted electrical receptacle should be installed.

Place the electrical supply flush with the back wall and within the shaded area shown in the illustrations. Placement within the opening may require additional cabinet depth.

FRONT VIEW

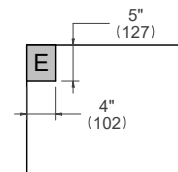

A separate circuit and a circuit breaker servicing only this appliance is recommended.

Electrical supply	120/240 V 60 Hz 3850 W
Service	16 Amp dedicated circuit
Power Connection	METAL CONDUIT – 59" cord

For detailed installation specifications consult the installation manual.

24" Convection Speed Ovens

Proud installation



TOP VIEW

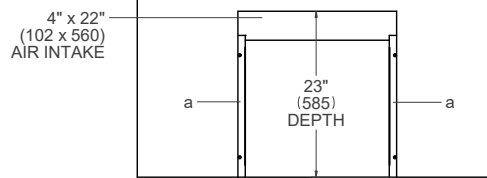

SIDE VIEW

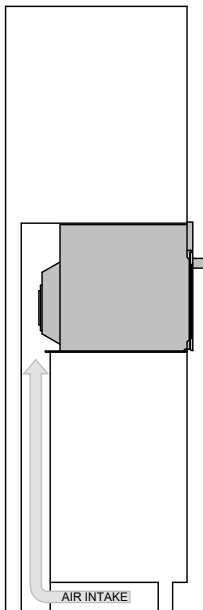

FRONT VIEW

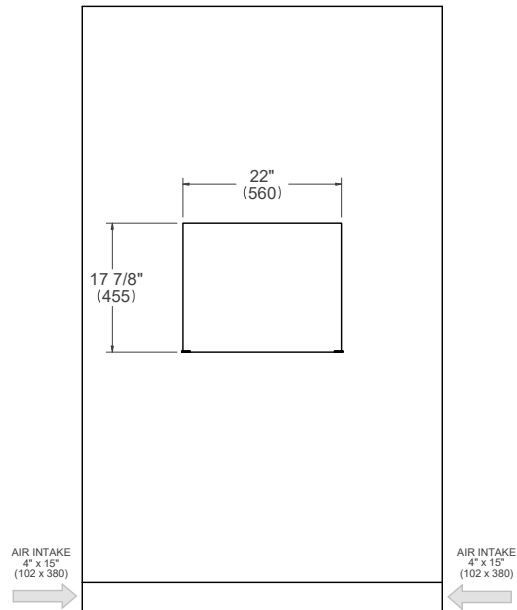

(a) Spacers - Included with appliance

24" Convection Speed Ovens

Flush installation



TOP VIEW

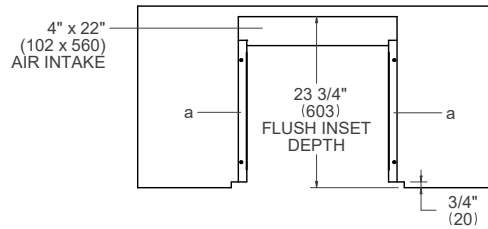

SIDE VIEW

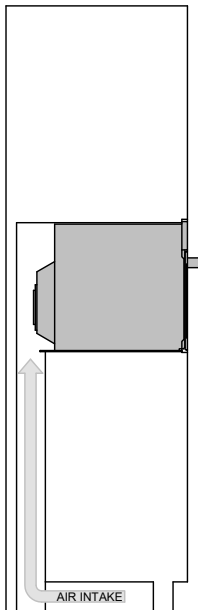

FRONT VIEW

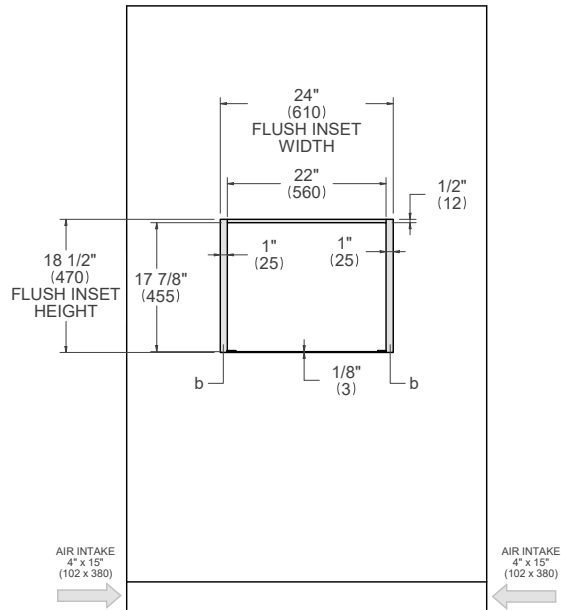

- (a) Spacers - Included with appliance
- (b) Visible Area - Match finish to outside cabinet panels

24" Convection Speed Ovens

Undercounter installation



TOP VIEW

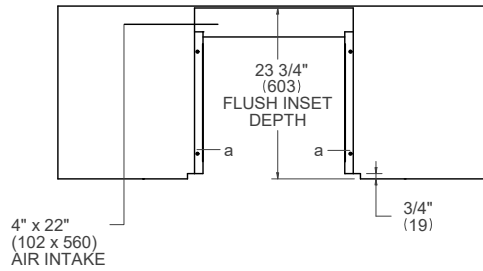

SIDE VIEW

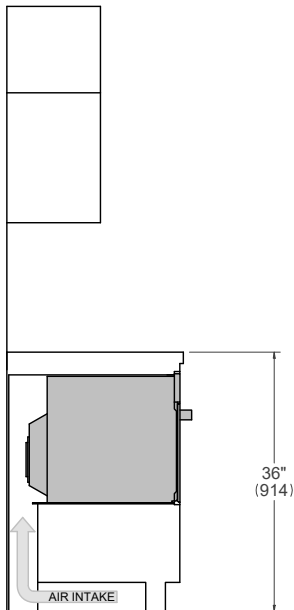

FRONT VIEW

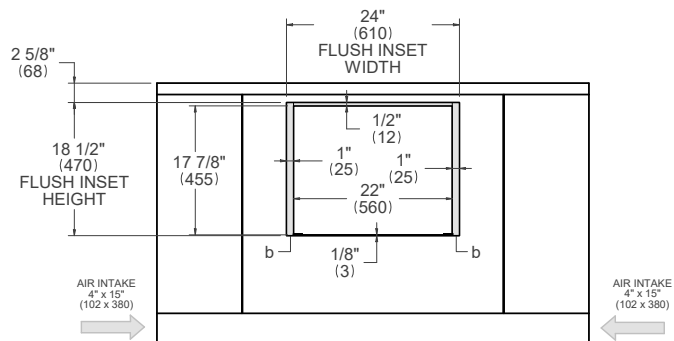

- (a) Spacers - Included with appliance
- (b) Visible Area - Match finish to outside cabinet panels

24" Microwave Drawer

Dimensions



MD24X

SIDE VIEW

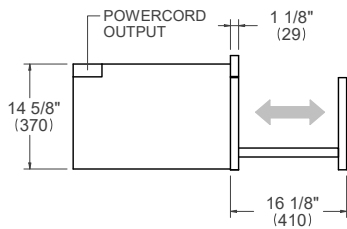

FRONT VIEW

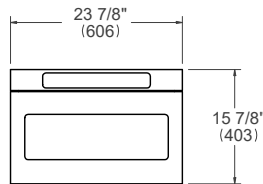

TOP VIEW

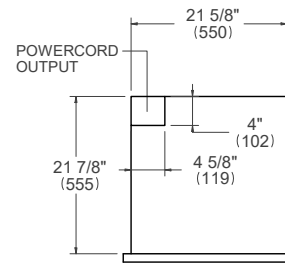

24" Microwave Drawer

Installation requirements



INSTALLATION

The oven can be installed in a proud or flush application. Finish the edges of the opening because they may be visible when the door is open.

The clearance between the oven and the kitchen units or other installed appliances must be enough to ensure sufficient cooling air ventilation.

For instructions and clearance of product combinations please see the Multiple Installation Sections (page 86).

CABINET REQUIREMENT

To prevent possible damage to cabinets and cabinet finishes, use only materials and finishes that will not discolor or delaminate and will withstand temperatures up to 195°F (90°C). Installation of the appliance must be performed in accordance with the provisions of applicable legislation.

BE SURE that support for this appliance is perpendicular to the front facing of the wall or cabinet before you perform the installation.

The cabinet base must be flat and capable of supporting the weight of the oven when in use.

Minimum Suggested Load on Cabinet Base Board	110lb (50kg)
---	--------------

ELECTRICAL REQUIREMENT

The installation must comply with all applicable electrical codes.

A properly-grounded horizontally- mounted electrical receptacle should be installed.

Place the electrical supply flush with the back wall and within the shaded area shown in the illustrations. Placement within the opening may require additional cabinet depth.

FRONT VIEW

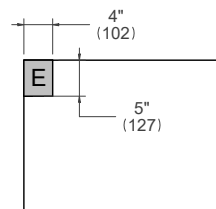

Electrical supply	120/240 V 60 Hz 1500 W
Service	15 Amp
Power Connection	NEMA 5-15P plug with 47" cord

For detailed installation specifications consult the installation manual.

24" Microwave Drawer

Flush installation



TOP VIEW

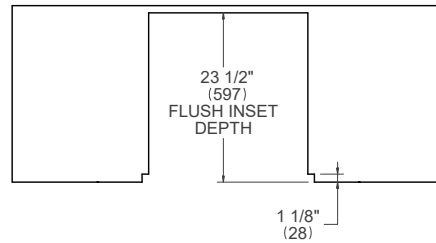

SIDE VIEW

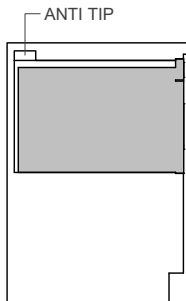

FRONT VIEW

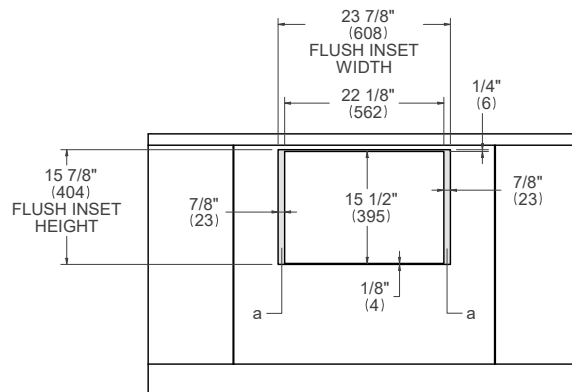

(a) Visible Area - Match finish to outside cabinet panels

GAS RANGETOPS & COOKTOPS



Bertazzoni rangetops and cooktops offer amazing versatility and feature a maximized cooking surface. Available in 24", 30", 36" and 48" versions, together with a variety of versatile burner configurations, these powerful models are the perfect pairing any Bertazzoni built-in oven.

Rangetops

48" Rangetops

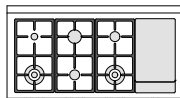

36" Rangetops

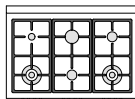

Side control drop-in cooktops

36" Drop-in Cooktops
6 burners

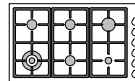

30" Drop-in Cooktops
5 burners

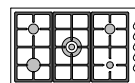

30" Drop-in Cooktops
4 burners

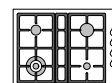

Front control built-in cooktops

36" Cooktops
5 burners

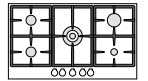

30" Cooktops
5 burners

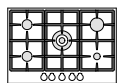

24" Cooktops
4 burners

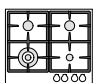



48" Rangetops

Dimensions



PROF486GRTBXT
MAST486GRTBXT

TOP VIEW

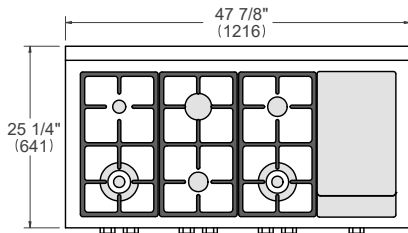

FRONT VIEW



SIDE VIEW

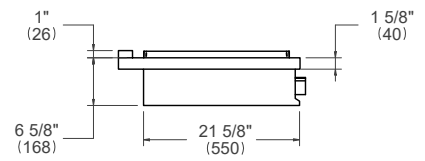

48" Rangetops

Installation requirements



INSTALLATION

The gas rangetops can be mounted in a standard installation sitting on top of the countertop surface.

If a drawer is placed under the appliance, avoid to put into this drawer flammable objects or not heat-resistant objects.

For installation with an updraft or downdraft hood, refer to the hood manufacturer's installation requirements.

For instructions and clearance of product combinations please see the Multiple Installation Sections (page 86).

CABINET REQUIREMENT

To prevent possible damage to cabinets and cabinet finishes, the countertop must be able to withstand temperatures up to 300°F (149°C). Installation of the appliance must be performed in accordance with the provisions of applicable legislation. BE SURE that support for this appliance is horizontale before you perform the installation. The cabinet base must be flat and capable of supporting the weight of the oven when in use.

Minimum Suggested Load on Cabinet Base Board	187 lb (85kg)
---	---------------

ELECTRICAL REQUIREMENT

The installation must comply with all applicable electrical codes. A properly-grounded horizontally- mounted electrical receptacle should be installed. Place the electrical supply flush with the back wall and within the shaded area shown in the illustrations. Placement within the opening may require additional cabinet depth.

For detailed installation specifications consult the installation manual.

FRONT VIEW

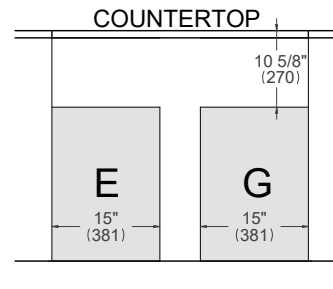

Electrical supply	120 V 60 Hz 1100 W
Service	10 Amp
Power Connection	NEMA 5-15P plug with 59" cord

GAS CONNECTION

The gas rangetops can be used with Natural or LP/Propane gas. An agency-approved, properly-sized manual shutoff valve should be installed. To connect gas between shut-off valve and regulator, use agency-approved, properly sized flexible or rigid pipe. Check all local code requirements.

Gas Inlet	1/2" NPT
Natural Gas	4" iwc (1.00 kPa)
LPG Gas	10" iwc (2.50 kPa)

Since service pressure may fluctuate with local demand, every gas cooktop must be equipped with the supplied pressure regulator on the incoming service line for safe and efficient operation.

48" Rangetops

Installation

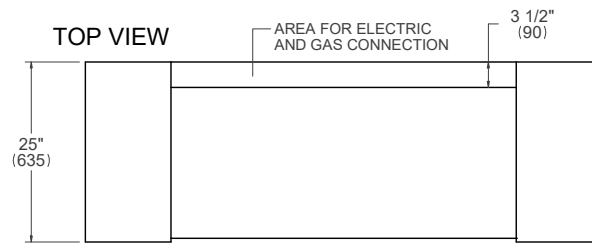

SIDE VIEW

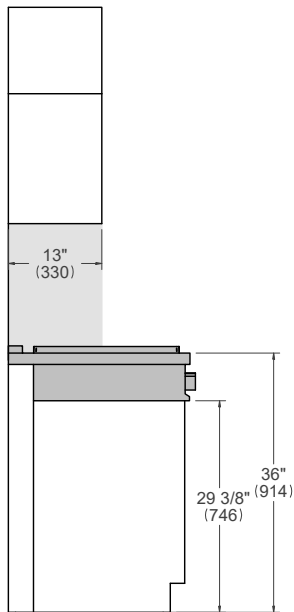

FRONT VIEW

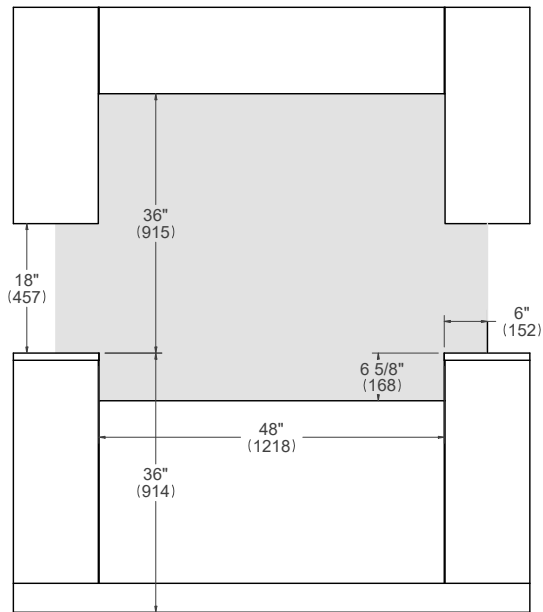

Combustible material cannot be located within shaded area.

36" Rangetops

Dimensions



PROF366RTBXT
MAST366RTBXT
MAST366RTXE

TOP VIEW

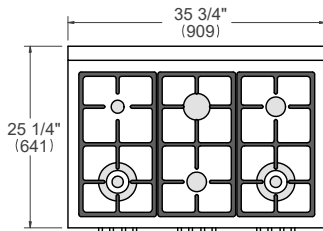

FRONT VIEW

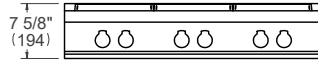

SIDE VIEW

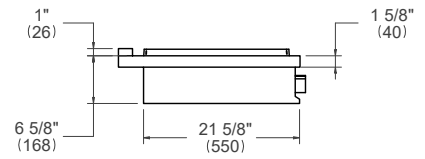

36" Rangetops

Installation requirements



INSTALLATION

The gas rangetops can be mounted in a standard installation sitting on top of the countertop surface.

If a drawer is placed under the appliance, avoid to put into this drawer flammable objects or not heat-resistant objects.

For installation with an updraft or downdraft hood, refer to the hood manufacturer's installation requirements.

For instructions and clearance of product combinations please see the Multiple Installation Sections (page 86).

CABINET REQUIREMENT

To prevent possible damage to cabinets and cabinet finishes, the countertop must be able to withstand temperatures up to 300°F (149°C). Installation of the appliance must be performed in accordance with the provisions of applicable legislation. BE SURE that support for this appliance is horizontale before you perform the installation. The cabinet base must be flat and capable of supporting the weight of the oven when in use.

Minimum Suggested Load on Cabinet Base Board	165lb (75kg)
---	--------------

ELECTRICAL REQUIREMENT

The installation must comply with all applicable electrical codes. A properly-grounded horizontally- mounted electrical receptacle should be installed. Place the electrical supply flush with the back wall and within the shaded area shown in the illustrations. Placement within the opening may require additional cabinet depth.

FRONT VIEW

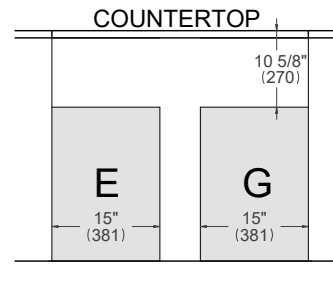

Electrical supply	120 V 60 Hz 1 W
Service	1 Amp
Power Connection	NEMA 5-15P plug with 59" cord

GAS CONNECTION

The gas rangetops can be used with Natural or LP/Propane gas. An agency-approved, properly-sized manual shutoff valve should be installed. To connect gas between shut-off valve and regulator, use agency-approved, properly sized flexible or rigid pipe. Check all local code requirements.

Gas Inlet	1/2" NPT
Natural Gas	4" iwc (1.00 kPa)
LPG Gas	10" iwc (2.50 kPa)

Since service pressure may fluctuate with local demand, every gas cooktop must be equipped with the supplied pressure regulator on the incoming service line for safe and efficient operation.

For detailed installation specifications consult the installation manual.

36" Rangetops

Installation

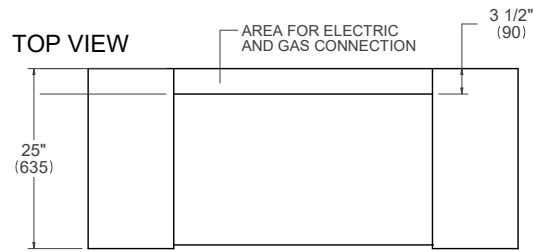

SIDE VIEW

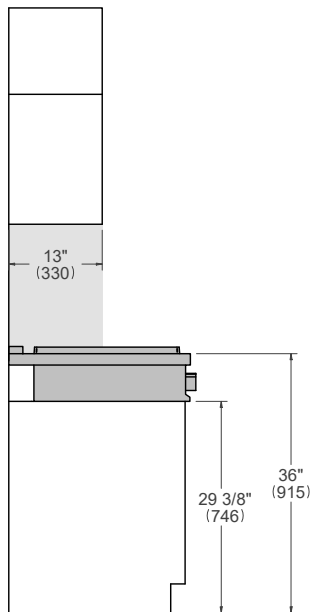

FRONT VIEW

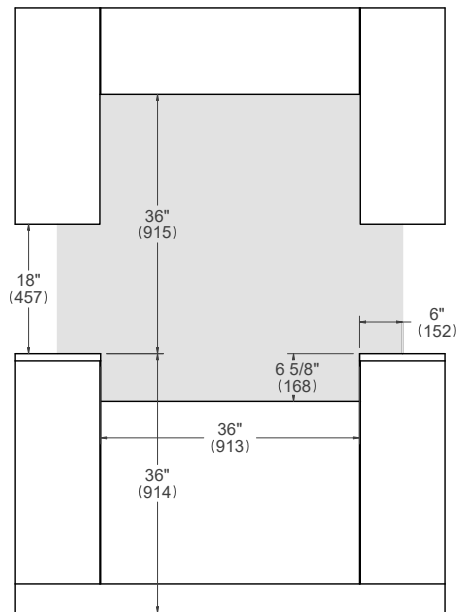

Combustible material cannot be located within shaded area.

36" Drop-in Cooktops 6 burners

Dimensions



PROF366QBXT
MAST366QBXT

TOP VIEW

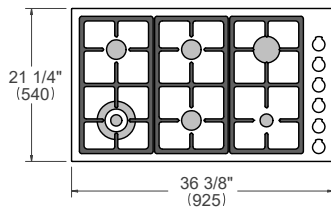

FRONT VIEW

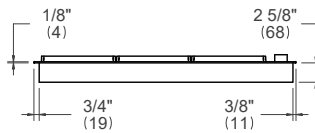

SIDE VIEW

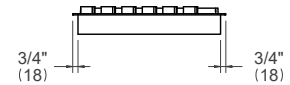

36" Drop-in Cooktops 6 burners

Installation requirements



INSTALLATION

The gas cooktop can be mounted in a standard installation sitting on top of the countertop surface.

The clearance between the hob and the kitchen furniture or other installed appliances must be enough to ensure sufficient cooling air ventilation.

If a drawer is placed under the work, avoid to put into this drawer flammable objects or not heat-resistant objects.

For installation with an updraft or downdraft hood as well as any OTR, refer to the hood/OTR manufacturer's installation requirements.

For instructions and clearance of product combinations please see the Multiple Installation Sections (page 86).

CABINET REQUIREMENT

To prevent possible damage to cabinets and cabinet finishes, the countertop must be able to withstand temperatures up to 300°F (149°C). Installation of the appliance must be performed in accordance with the provisions of applicable legislation. BE SURE that support for this appliance is horizontale before you perform the installation. The cabinet base must be flat and capable of supporting the weight of the oven when in use.

Minimum Suggested Load on Cabinet Base Board	132lb (60kg)
---	--------------

ELECTRICAL REQUIREMENT

The installation must comply with all applicable electrical codes. A properly-grounded horizontally- mounted electrical receptacle should be installed. Place the electrical supply flush with the back wall and within the shaded area shown in the illustrations. Placement within the opening may require additional cabinet depth.

FRONT VIEW

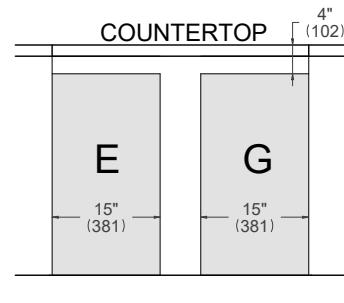

Electrical supply	120 V 60 Hz 1 W
Service	1 Amp
Power Connection	NEMA 5-15P plug with 59" cord

GAS CONNECTION

The gas cooktop can be used with Natural or LP/Propane gas. An agency-approved, properly-sized manual shutoff valve should be installed. To connect gas between shut-off valve and regulator, use agency-approved, properly sized flexible or rigid pipe. Check all local code requirements.

Gas Inlet	1/2" NPT
Natural Gas	4" iwc (1.00 kPa)
LPG Gas	10" iwc (2.50 kPa)

Since service pressure may fluctuate with local demand, every gas cooktop must be equipped with the supplied pressure regulator on the incoming service line for safe and efficient operation.

For detailed installation specifications consult the installation manual.

36" Drop-in Cooktops 6 burners

Installation



TOP VIEW

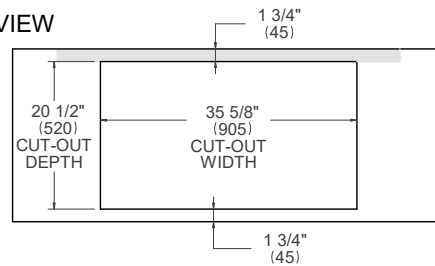

SIDE VIEW

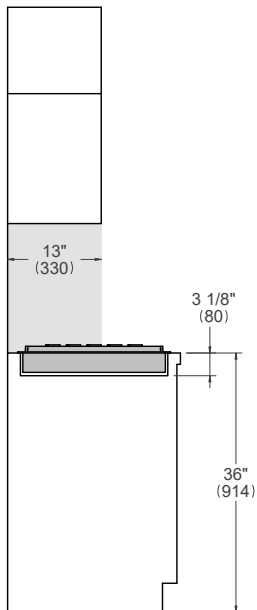

FRONT VIEW

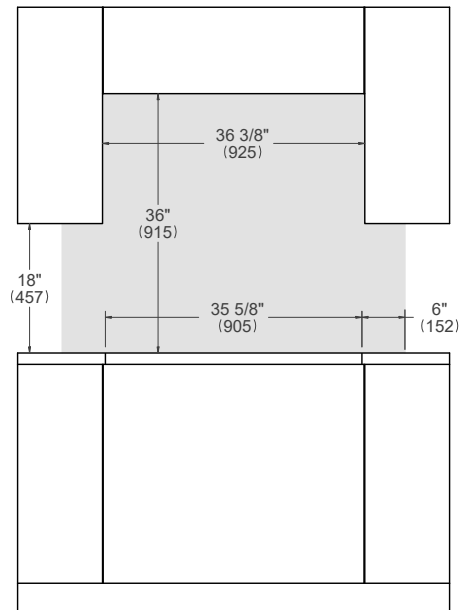

Combustible material cannot be installed within shaded area.

36" Drop-in Cooktops 5 burners

Dimensions



PROF365QBXT
PROF365QXE

MAST365QBXT
MAST365QXE

TOP VIEW

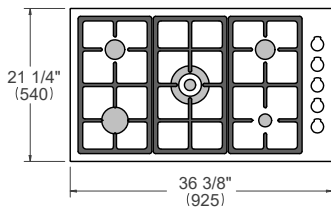

FRONT VIEW

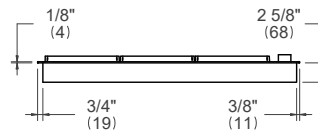

SIDE VIEW

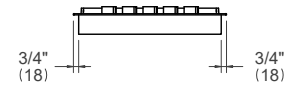

36" Drop-in Cooktops 5 burners

Installation requirements



INSTALLATION

The gas cooktop can be mounted in a standard installation sitting on top of the countertop surface.

The clearance between the hob and the kitchen furniture or other installed appliances must be enough to ensure sufficient cooling air ventilation.

If a drawer is placed under the work, avoid to put into this drawer flammable objects or not heat-resistant objects.

For installation with an updraft or downdraft hood as well as any OTR, refer to the hood/OTR manufacturer's installation requirements.

For instructions and clearance of product combinations please see the Multiple Installation Sections (page 86).

CABINET REQUIREMENT

To prevent possible damage to cabinets and cabinet finishes, the countertop must be able to withstand temperatures up to 300°F (149°C). Installation of the appliance must be performed in accordance with the provisions of applicable legislation. BE SURE that support for this appliance is horizontale before you perform the installation. The cabinet base must be flat and capable of supporting the weight of the oven when in use.

Minimum Suggested Load on Cabinet Base Board	125lb (57kg)
---	--------------

ELECTRICAL REQUIREMENT

The installation must comply with all applicable electrical codes. A properly-grounded horizontally- mounted electrical receptacle should be installed. Place the electrical supply flush with the back wall and within the shaded area shown in the illustrations. Placement within the opening may require additional cabinet depth.

FRONT VIEW

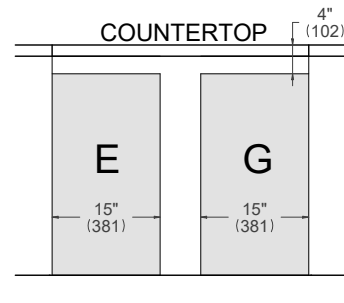

Electrical supply	120 V 60 Hz 1 W
Service	1 Amp
Power Connection	NEMA 5-15P plug with 59" cord

GAS CONNECTION

The gas cooktop can be used with Natural or LP/Propane gas. An agency-approved, properly-sized manual shutoff valve should be installed. To connect gas between shut-off valve and regulator, use agency-approved, properly sized flexible or rigid pipe. Check all local code requirements.

Gas Inlet	1/2" NPT
Natural Gas	4" iwc (1.00 kPa)
LPG Gas	10" iwc (2.50 kPa)

Since service pressure may fluctuate with local demand, every gas cooktop must be equipped with the supplied pressure regulator on the incoming service line for safe and efficient operation.

For detailed installation specifications consult the installation manual.

36" Drop-in Cooktops 5 burners

Installation



TOP VIEW

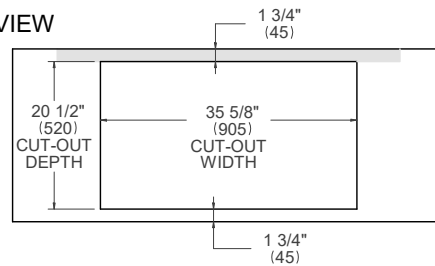

SIDE VIEW

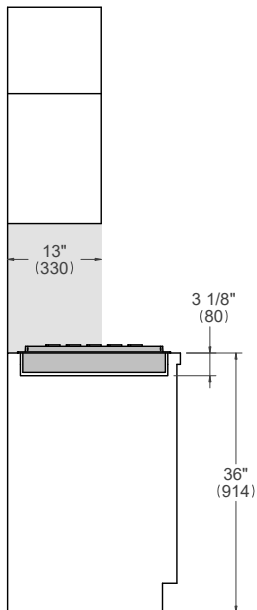

FRONT VIEW

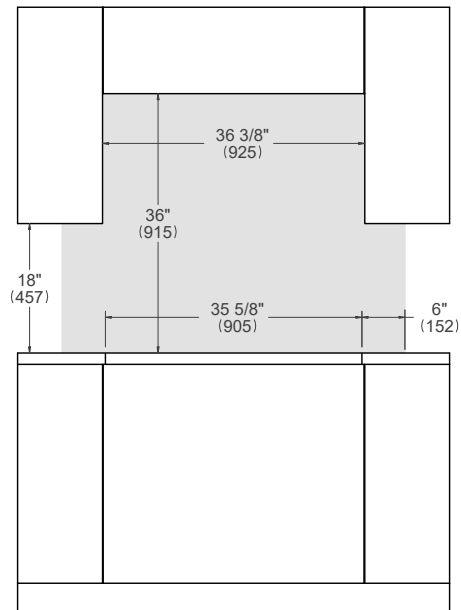

Combustible material cannot be installed within shaded area.

30" Drop-in Cooktops

Dimensions



PROF304QBXT
PROF304QXE

MAST304QBXT
MAST304QXE

TOP VIEW

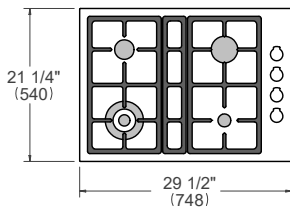

FRONT VIEW

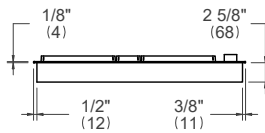

SIDE VIEW



30" Drop-in Cooktops

Installation requirements



INSTALLATION

The gas cooktop can be mounted in a standard installation sitting on top of the countertop surface.

The clearance between the hob and the kitchen furniture or other installed appliances must be enough to ensure sufficient cooling air ventilation.

If a drawer is placed under the work, avoid to put into this drawer flammable objects or not heat-resistant objects.

For installation with an updraft or downdraft hood as well as any OTR, refer to the hood/OTR manufacturer's installation requirements.

For instructions and clearance of product combinations please see the Multiple Installation Sections (page 86).

CABINET REQUIREMENT

To prevent possible damage to cabinets and cabinet finishes, the countertop must be able to withstand temperatures up to 300°F (149°C). Installation of the appliance must be performed in accordance with the provisions of applicable legislation. BE SURE that support for this appliance is horizontale before you perform the installation. The cabinet base must be flat and capable of supporting the weight of the oven when in use.

Minimum Suggested Load on Cabinet Base Board	110lb (50kg)
---	--------------

ELECTRICAL REQUIREMENT

The installation must comply with all applicable electrical codes. A properly-grounded horizontally- mounted electrical receptacle should be installed. Place the electrical supply flush with the back wall and within the shaded area shown in the illustrations. Placement within the opening may require additional cabinet depth.

FRONT VIEW

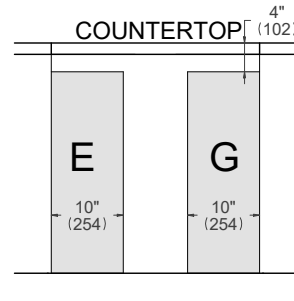

Electrical supply	120 V 60 Hz 1 W
Service	1 Amp
Power Connection	NEMA 5-15P plug with 59" cord

GAS CONNECTION

The gas cooktop can be used with Natural or LP/Propane gas. An agency-approved, properly-sized manual shutoff valve should be installed. To connect gas between shut-off valve and regulator, use agency-approved, properly sized flexible or rigid pipe. Check all local code requirements.

Gas Inlet	1/2" NPT
Natural Gas	4" iwc (1.00 kPa)
LPG Gas	10" iwc (2.50 kPa)

Since service pressure may fluctuate with local demand, every gas cooktop must be equipped with the supplied pressure regulator on the incoming service line for safe and efficient operation.

For detailed installation specifications consult the installation manual.

30" Drop-in Cooktops

Installation



TOP VIEW

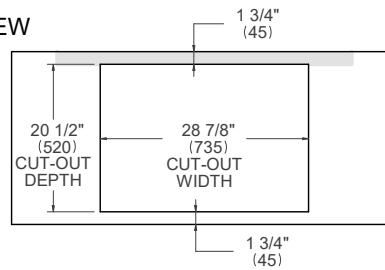

SIDE VIEW

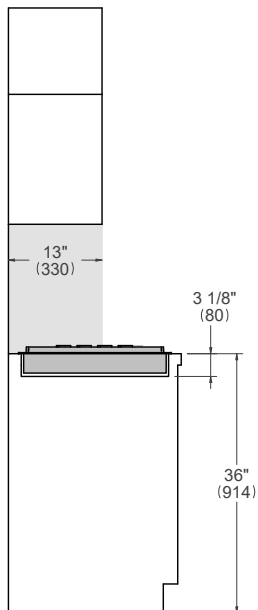

FRONT VIEW

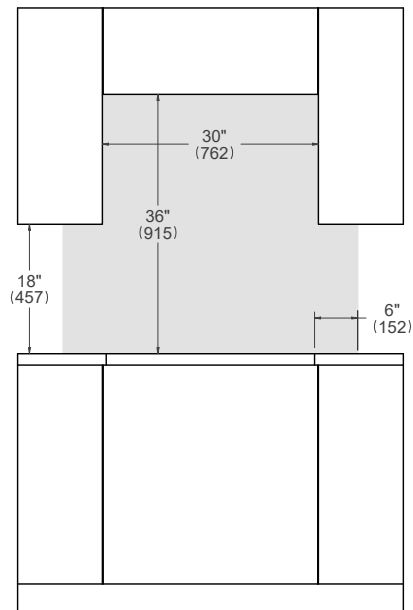

Combustible material cannot be installed within shaded area.

36" Gas Cooktop Front Control

Dimensions



PROF365CTXV

TOP VIEW

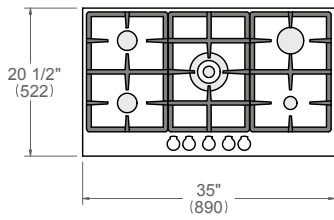

FRONT VIEW



SIDE VIEW



36" Gas Cooktop Front Control

Installation requirements



INSTALLATION

The gas cooktop can be mounted in a standard installation sitting on top of the countertop surface.

The clearance between the hob and the kitchen furniture or other installed appliances must be enough to ensure sufficient cooling air ventilation.

If a drawer is placed under the work, avoid to put into this drawer flammable objects or not heat-resistant objects.

For installation with an updraft or downdraft hood as well as any OTR, refer to the hood/OTR manufacturer's installation requirements.

For instructions and clearance of product combinations please see the Multiple Installation Sections (page 86).

CABINET REQUIREMENT

To prevent possible damage to cabinets and cabinet finishes, the countertop must be able to withstand temperatures up to 300°F (149°C). Installation of the appliance must be performed in accordance with the provisions of applicable legislation. BE SURE that support for this appliance is horizontale before you perform the installation. The cabinet base must be flat and capable of supporting the weight of the oven when in use.

Minimum Suggested Load on Cabinet Base Board	88lb (40kg)
---	-------------

ELECTRICAL REQUIREMENT

The installation must comply with all applicable electrical codes. A properly-grounded horizontally- mounted electrical receptacle should be installed. Place the electrical supply flush with the back wall and within the shaded area shown in the illustrations. Placement within the opening may require additional cabinet depth.

FRONT VIEW

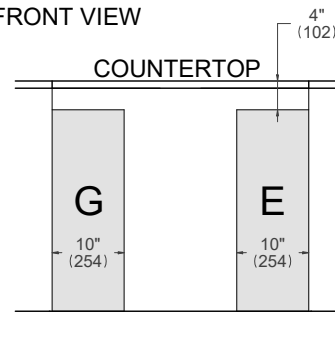

Electrical supply	120 V 60 Hz 1 W
Service	1 Amp
Power Connection	NEMA 5-15P plug with 59" cord

GAS CONNECTION

The gas cooktop can be used with Natural or LP/Propane gas. An agency-approved, properly-sized manual shutoff valve should be installed. To connect gas between shut-off valve and regulator, use agency-approved, properly sized flexible or rigid pipe. Check all local code requirements.

Gas Inlet	1/2" NPT
Natural Gas	4" iwc (1.00 kPa)
LPG Gas	10" iwc (2.50 kPa)

Since service pressure may fluctuate with local demand, every gas cooktop must be equipped with the supplied pressure regulator on the incoming service line for safe and efficient operation.

For detailed installation specifications consult the installation manual.

36" Gas Cooktop Front Control Installation

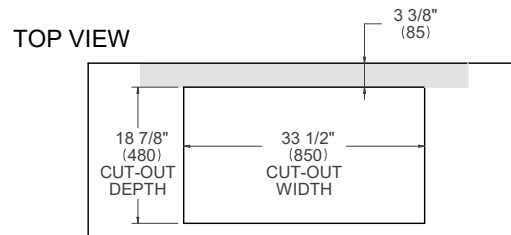

SIDE VIEW

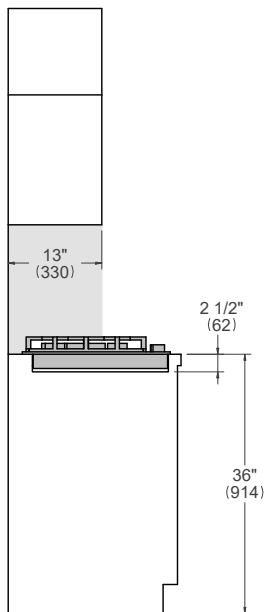

FRONT VIEW

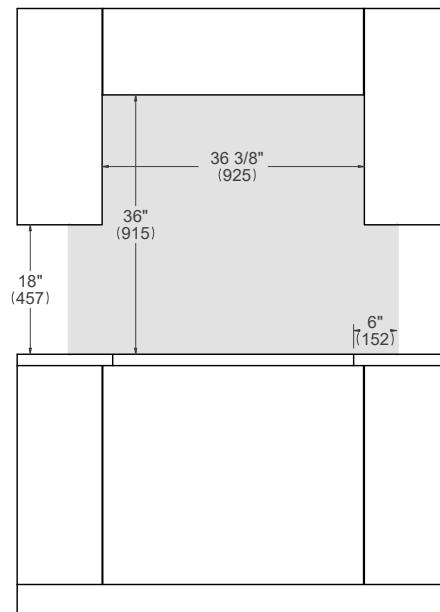

Combustible material cannot be installed within shaded area.

30" Gas Cooktop Front Control

Dimensions



PROF305CTXV

TOP VIEW

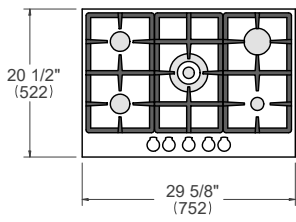

FRONT VIEW

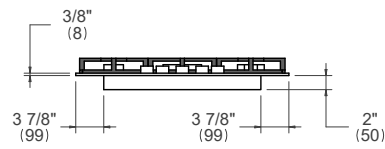

SIDE VIEW



30" Gas Cooktop Front Control

Installation requirements



INSTALLATION

The gas cooktop can be mounted in a standard installation sitting on top of the countertop surface.

The clearance between the hob and the kitchen furniture or other installed appliances must be enough to ensure sufficient cooling air ventilation.

If a drawer is placed under the work, avoid to put into this drawer flammable objects or not heat-resistant objects.

For installation with an updraft or downdraft hood as well as any OTR, refer to the hood/OTR manufacturer's installation requirements.

For instructions and clearance of product combinations please see the Multiple Installation Sections (page 86).

CABINET REQUIREMENT

To prevent possible damage to cabinets and cabinet finishes, the countertop must be able to withstand temperatures up to 300°F (149°C). Installation of the appliance must be performed in accordance with the provisions of applicable legislation. BE SURE that support for this appliance is horizontale before you perform the installation. The cabinet base must be flat and capable of supporting the weight of the oven when in use.

Minimum Suggested Load on Cabinet Base Board	81lb (37kg)
---	-------------

ELECTRICAL REQUIREMENT

The installation must comply with all applicable electrical codes. A properly-grounded horizontally- mounted electrical receptacle should be installed. Place the electrical supply flush with the back wall and within the shaded area shown in the illustrations. Placement within the opening may require additional cabinet depth.

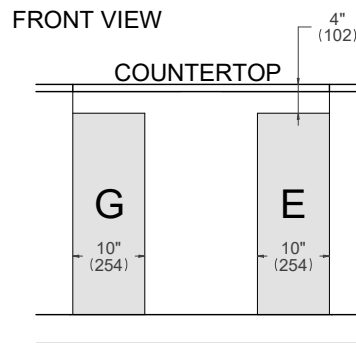

Electrical supply	120 V 60 Hz 1 W
Service	1 Amp
Power Connection	NEMA 5-15P plug with 59" cord

GAS CONNECTION

The gas cooktop can be used with Natural or LP/Propane gas. An agency-approved, properly-sized manual shutoff valve should be installed. To connect gas between shut-off valve and regulator, use agency-approved, properly sized flexible or rigid pipe. Check all local code requirements.

Gas Inlet	1/2" NPT
Natural Gas	4" iwc (1.00 kPa)
LPG Gas	10" iwc (2.50 kPa)

Since service pressure may fluctuate with local demand, every gas cooktop must be equipped with the supplied pressure regulator on the incoming service line for safe and efficient operation.

For detailed installation specifications consult the installation manual.

30" Gas Cooktop Front Control Installation



TOP VIEW

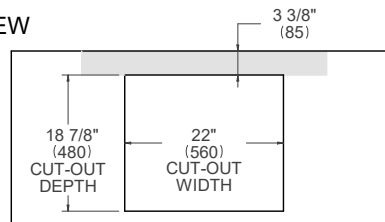

SIDE VIEW

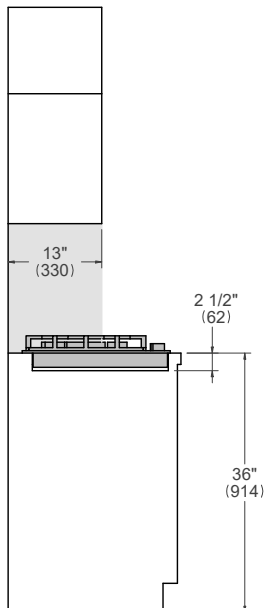

FRONT VIEW

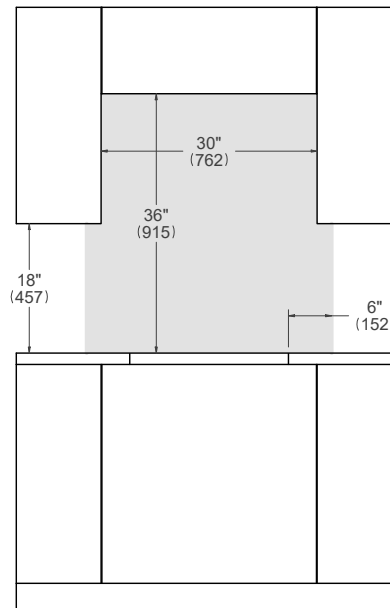

Combustible material cannot be installed within shaded area.

24" Gas Cooktop Front Control

Dimensions



PROF244CTXV

TOP VIEW

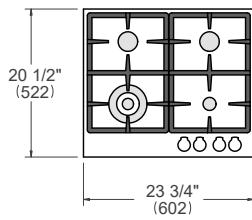

FRONT VIEW

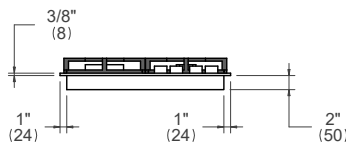

SIDE VIEW



24" Gas Cooktop Front Control

Installation requirements



INSTALLATION

The gas cooktop can be mounted in a standard installation sitting on top of the countertop surface.

The clearance between the hob and the kitchen furniture or other installed appliances must be enough to ensure sufficient cooling air ventilation.

If a drawer is placed under the work, avoid to put into this drawer flammable objects or not heat-resistant objects.

For installation with an updraft or downdraft hood as well as any OTR, refer to the hood/OTR manufacturer's installation requirements.

For instructions and clearance of product combinations please see the Multiple Installation Sections (page 86).

CABINET REQUIREMENT

To prevent possible damage to cabinets and cabinet finishes, the countertop must be able to withstand temperatures up to 300°F (149°C). Installation of the appliance must be performed in accordance with the provisions of applicable legislation. **BE SURE** that support for this appliance is horizontal before you perform the installation. The cabinet base must be flat and capable of supporting the weight of the oven when in use.

Minimum Suggested Load on Cabinet Base Board	84lb (38kg)
---	-------------

ELECTRICAL REQUIREMENT

The installation must comply with all applicable electrical codes. A properly-grounded horizontally-mounted electrical receptacle should be installed. Place the electrical supply flush with the back wall and within the shaded area shown in the illustrations. Placement within the opening may require additional cabinet depth.

FRONT VIEW

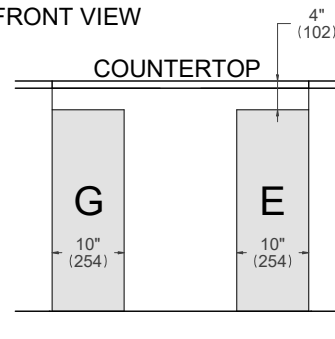

Electrical supply	120 V 60 Hz 1 W
Service	1 Amp
Power Connection	NEMA 5-15P plug with 59" cord

GAS CONNECTION

The gas cooktop can be used with Natural or LP/Propane gas. An agency-approved, properly-sized manual shutoff valve should be installed. To connect gas between shut-off valve and regulator, use agency-approved, properly sized flexible or rigid pipe. Check all local code requirements.

Gas Inlet	1/2" NPT
Natural Gas	4" iwc (1.00 kPa)
LPG Gas	10" iwc (2.50 kPa)

Since service pressure may fluctuate with local demand, every gas cooktop must be equipped with the supplied pressure regulator on the incoming service line for safe and efficient operation.

For detailed installation specifications consult the installation manual.

24" Gas Cooktop Front Control Installation



TOP VIEW

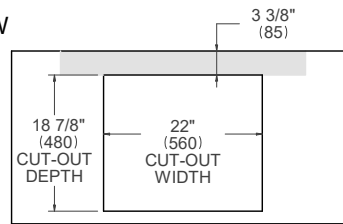

SIDE VIEW

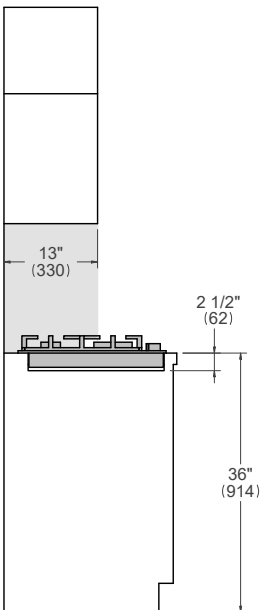

FRONT VIEW

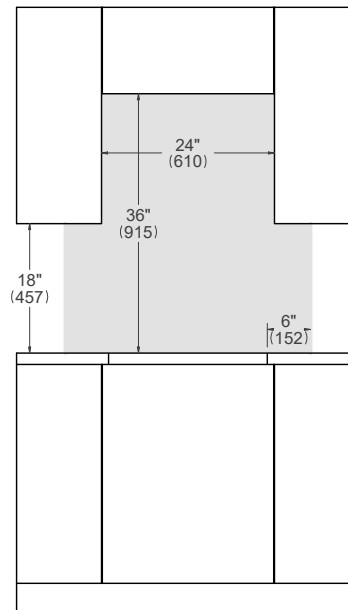

Combustible material cannot be installed within shaded area.

INDUCTION & ELECTRIC COOKTOPS



Electric induction and electric CERAN® cooktops add an elegant and clean look to your kitchen, with the added advantage of faster induction heating. On the induction models, precision touch controls and digital timed cooking functions let you automatically manage the entire cooking process; sensor controlled cookware detection means all the energy is used to heat the exact space instantly from the moment you turn them on. They make preparing a wide variety of dishes effortless, with 5 or 4 zones for cooking. And when you've finished cooking, cleaning up is equally straightforward.

Induction

36" Induction Cooktop

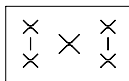

CERAN®

30" Electric Ceramic Cooktop

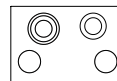

30" Induction Cooktop

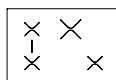

24" Electric Ceramic Cooktop





36" Induction Cooktop

Dimensions



P365IAE

TOP VIEW

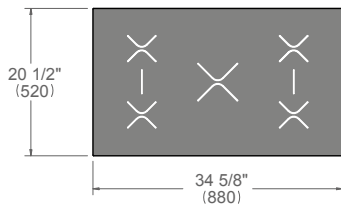

FRONT VIEW

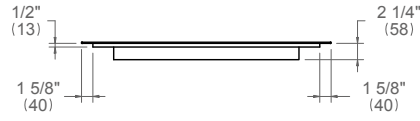

SIDE VIEW

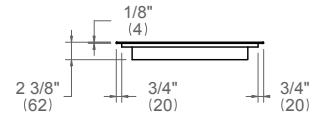

36" Induction Cooktop

Installation requirement



INSTALLATION

The induction cooktop can be mounted in a standard installation sitting on top of the countertop surface. The clearance between the hob and the kitchen furniture or other installed appliances must be enough to ensure sufficient cooling air ventilation. For installation with an updraft or downdraft hood as well as any OTR, refer to the hood/OTR manufacturer's installation requirements. If a drawer is placed under the worktop, avoid to put into this drawer flammable objects or not heat-resistant objects.

For instructions and clearance of product combinations please see the Multiple Installation Sections (page 86).

CABINET REQUIREMENT

To prevent possible damage to cabinets and cabinet finishes, the countertop must be able to withstand temperatures up to 300°F (149°C).

Installation of the appliance must be performed in accordance with the provisions of applicable legislation.

BE SURE that support for this appliance is horizontal before you perform the installation.

The cabinet base must be flat and capable of supporting the weight of the oven when in use.

Minimum Suggested Load on Cabinet Base Board	110 lb (50kg)
---	---------------

ELECTRICAL REQUIREMENT

A properly-grounded horizontally- mounted electrical receptacle should be installed.

The installation must comply with all applicable electrical codes. Place the electrical supply flush with the back wall and within the shaded area shown in the illustrations. Placement within the opening may require additional cabinet depth.

FRONT VIEW

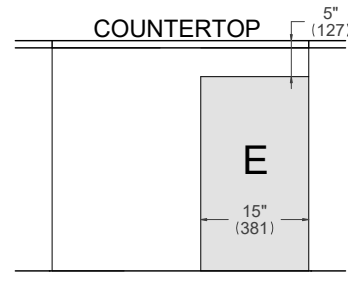

A separate circuit and a circuit breaker servicing only this appliance is recommended.

Electrical supply	208/240 V 60 Hz 11100 W
Service	55 Amp dedicated circuit
Power Connection	METAL CONDUIT - 54" cord

For detailed installation specifications consult the installation manual.

36" Induction Cooktop Installation



TOP VIEW

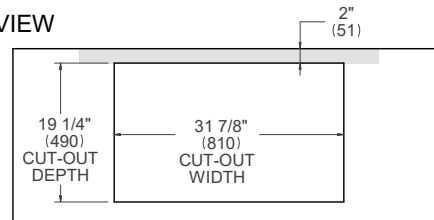

SIDE VIEW

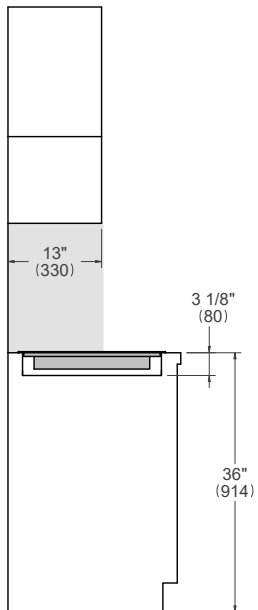

FRONT VIEW

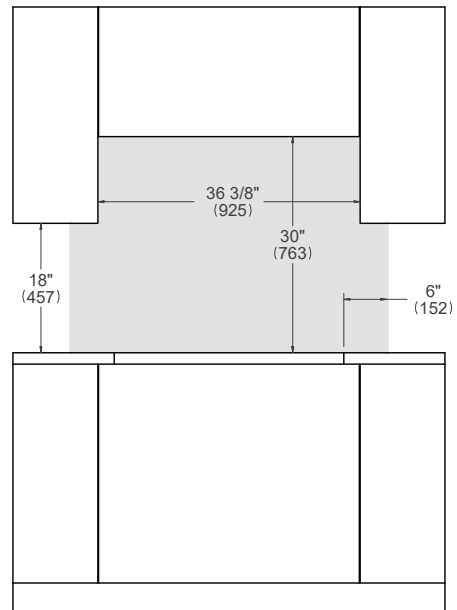

Combustible material cannot be installed within shaded area.

30" Induction Cooktop

Dimensions



P304IAE

TOP VIEW

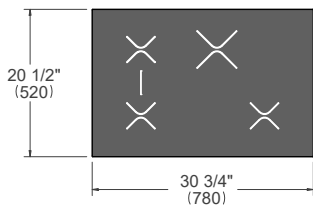

FRONT VIEW

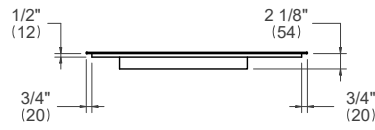

SIDE VIEW

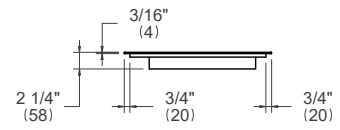

30" Induction Cooktop

Installation requirements



INSTALLATION

The induction cooktop can be mounted in a standard installation sitting on top of the countertop surface. The clearance between the hob and the kitchen furniture or other installed appliances must be enough to ensure sufficient cooling air ventilation. For installation with an updraft or downdraft hood as well as any OTR, refer to the hood/OTR manufacturer's installation requirements. If a drawer is placed under the worktop, avoid to put into this drawer flammable objects or not heat-resistant objects.

For instructions and clearance of product combinations please see the Multiple Installation Sections (page 86).

CABINET REQUIREMENT

To prevent possible damage to cabinets and cabinet finishes, the countertop must be able to withstand temperatures up to 300°F (149°C).

Installation of the appliance must be performed in accordance with the provisions of applicable legislation.

BE SURE that support for this appliance is horizontal before you perform the installation.

The cabinet base must be flat and capable of supporting the weight of the oven when in use.

Minimum Suggested Load on Cabinet Base Board	88lb (40kg)
---	-------------

ELECTRICAL REQUIREMENT

A properly-grounded horizontally- mounted electrical receptacle should be installed.

The installation must comply with all applicable electrical codes. Place the electrical supply flush with the back wall and within the shaded area shown in the illustrations. Placement within the opening may require additional cabinet depth.

FRONT VIEW

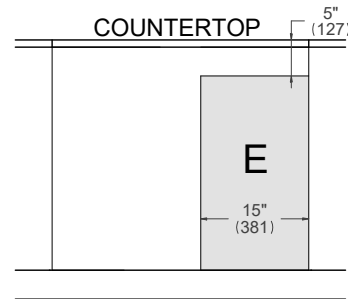

A separate circuit and a circuit breaker servicing only this appliance is recommended.

Electrical supply	208/240 V 60 Hz 7400 W
Service	40 Amp dedicated circuit
Power Connection	METAL CONDUIT - 54" cord

30" Induction Cooktop Installation



TOP VIEW

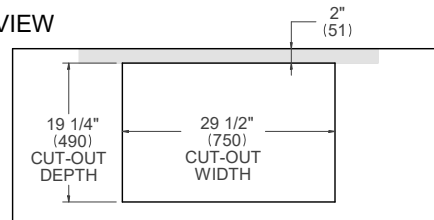

SIDE VIEW

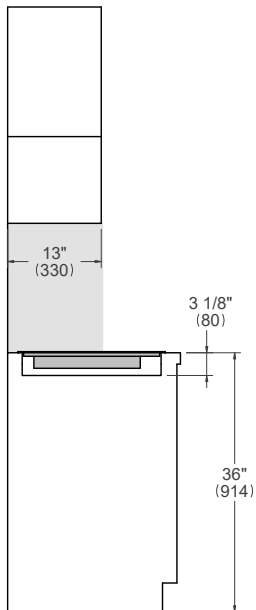

FRONT VIEW

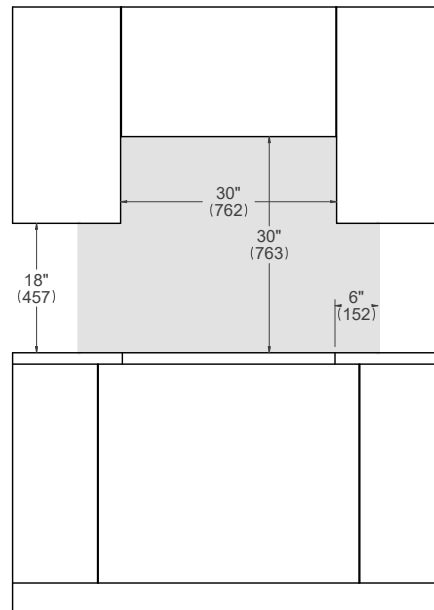

Combustible material cannot be installed within shaded area.

30" Electric Ceramic Cooktop

Dimensions



PE304CER

TOP VIEW

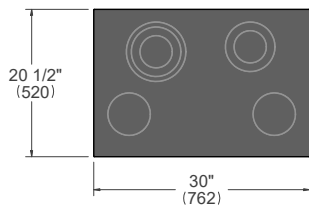

FRONT VIEW

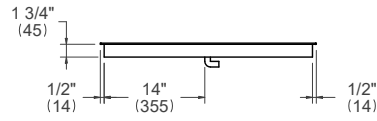

SIDE VIEW

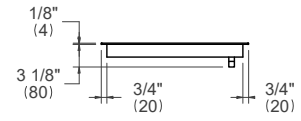

30" Electric Ceramic Cooktop

Installation requirements



INSTALLATION

The electric cooktop can be mounted in a standard installation sitting on top of the countertop surface.

The clearance between the hob and the kitchen furniture or other installed appliances must be enough to ensure sufficient cooling air ventilation.

If a drawer is placed under the worktop, avoid to put into this drawer flammable objects or not heat-resistant objects.

For instructions and clearance of product combinations please see the Multiple Installation Sections.

CABINET REQUIREMENT

To prevent possible damage to cabinets and cabinet finishes, the countertop must be able to withstand temperatures up to 300°F (149°C).

Installation of the appliance must be performed in accordance with the provisions of applicable legislation.

BE SURE that support for this appliance is horizontale before you perform the installation.

The cabinet base must be flat and capable of supporting the weight of the oven when in use.

Minimum Suggested Load on Cabinet Base Board	88lb (40kg)
---	-------------

ELECTRICAL REQUIREMENT

A properly-grounded horizontally- mounted electrical receptacle should be installed.

The installation must comply with all applicable electrical codes. Place the electrical supply flush with the back wall and within the shaded area shown in the illustrations. Placement within the opening may require additional cabinet depth.

FRONT VIEW

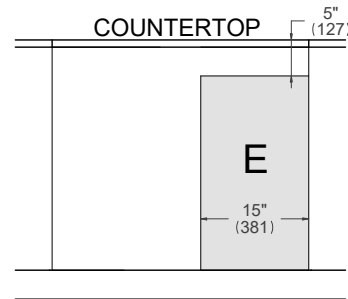

A separate circuit and a circuit breaker servicing only this appliance is recommended

Electrical supply	240 V	60 Hz	6400 W
	208 V	31 A	60 Hz 4800 W
Service	35 Amp dedicated circuit		
Power Connection	METAL CONDUIT - 5/8" cord		

For detailed installation specifications consult the installation manual.

30" Electric Ceramic Cooktop

Installation



TOP VIEW

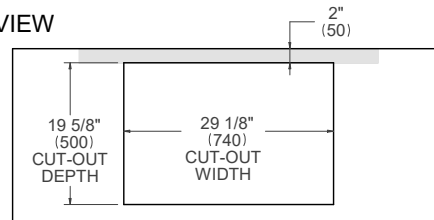

SIDE VIEW

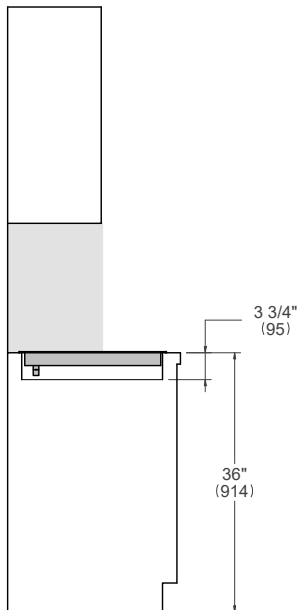

FRONT VIEW

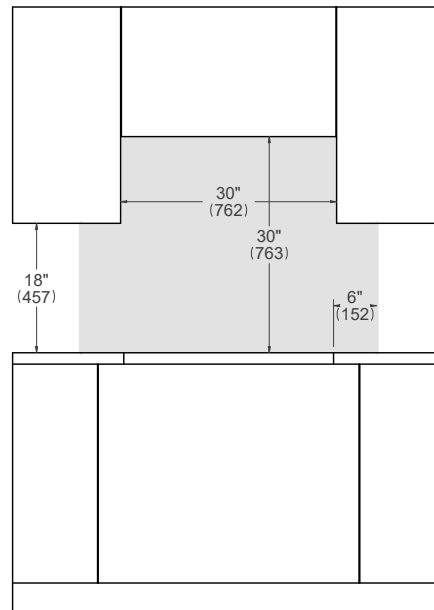

Combustible material cannot be installed within shaded area.

24" Electric Ceramic Cooktop

Dimensions



PE244CER

TOP VIEW

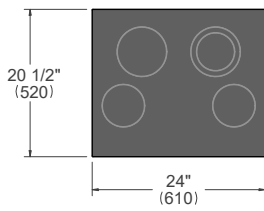

FRONT VIEW

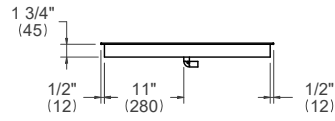

SIDE VIEW

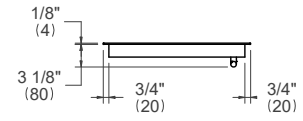

24" Electric Ceramic Cooktop

Installation requirements



INSTALLATION

The electric cooktop can be mounted in a standard installation sitting on top of the countertop surface.

The clearance between the hob and the kitchen furniture or other installed appliances must be enough to ensure sufficient cooling air ventilation.

If a drawer is placed under the worktop, avoid to put into this drawer flammable objects or not heat-resistant objects.

For instructions and clearance of product combinations please see the Multiple Installation Sections.

CABINET REQUIREMENT

To prevent possible damage to cabinets and cabinet finishes, the countertop must be able to withstand temperatures up to 300°F (149°C).

Installation of the appliance must be performed in accordance with the provisions of applicable legislation.

BE SURE that support for this appliance is horizontale before you perform the installation.

The cabinet base must be flat and capable of supporting the weight of the oven when in use.

Minimum Suggested Load on Cabinet Base Board	84lb (38kg)
---	-------------

ELECTRICAL REQUIREMENT

A properly-grounded horizontally- mounted electrical receptacle should be installed.

The installation must comply with all applicable electrical codes. Place the electrical supply flush with the back wall and within the shaded area shown in the illustrations. Placement within the opening may require additional cabinet depth.

FRONT VIEW

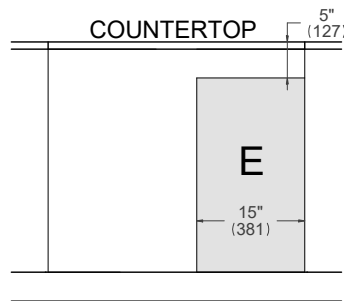

A separate circuit and a circuit breaker servicing only this appliance is recommended

Electrical supply	240 V	60 Hz	5900 W
	208 V	28 A	60 Hz 4200 W
Service	30 Amp dedicated circuit		
Power Connection	METAL CONDUIT - 5/8" cord		

24" Electric Ceramic Cooktop

Installation



TOP VIEW

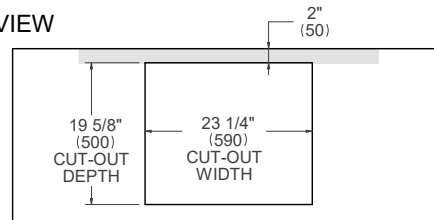

SIDE VIEW

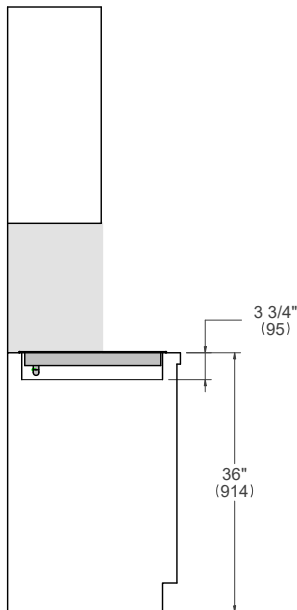

FRONT VIEW

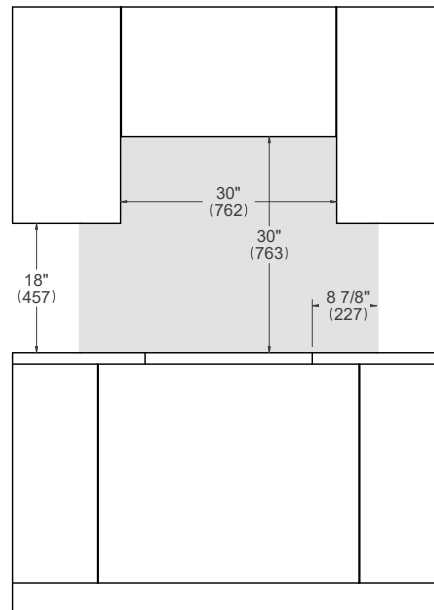

Combustible material cannot be installed within shaded area.

MULTIPLE INSTALLATIONS



BUILD YOUR SUITE

Select the perfect combination from the following pages to build a unique kitchen – the true heart of the home, where people can experience the Bertazzoni joy of family, food and engineering.

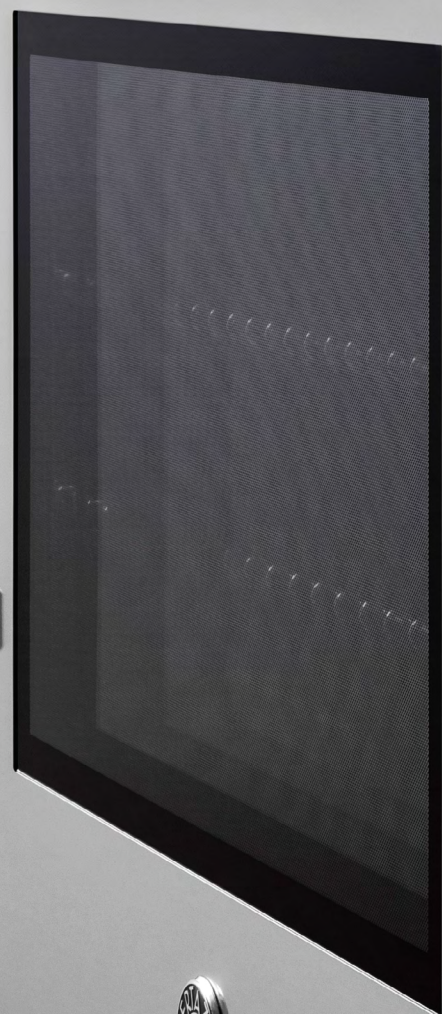
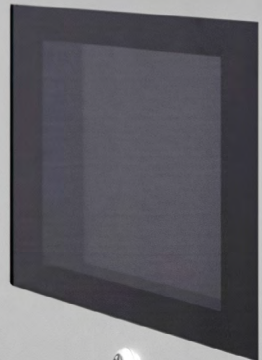

30" Specialty Oven + 30" Convection Single Oven + 30" Warming Drawer

Proud installation

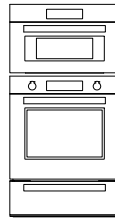

PROF30SOEX	PROF30FSEXT	PROF30WDEX
PROF30CSEX	PROF30FSE XV	MAST30WDEX
MAST30SOEX	MAST30FSEXT	
MAST30CSEX	MAST30FSE XV	

TOP VIEW

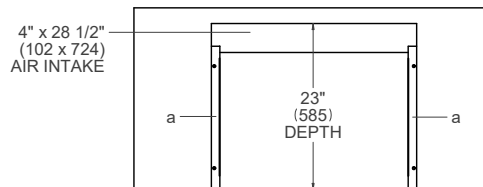

SIDE VIEW

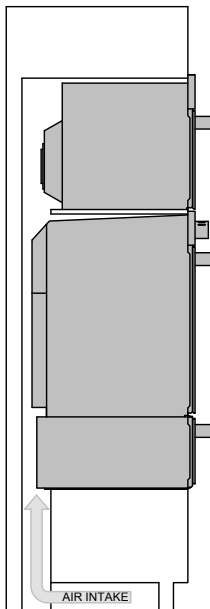

FRONT VIEW

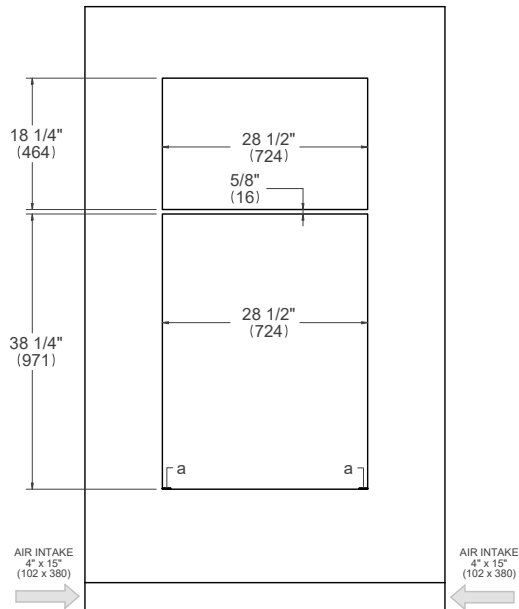

(a) Spacers - Included with appliance

For electrical and gas supply please see single installation requirements. Placement within the opening may require additional cabinet depth.

30" Specialty Oven + 30" Convection Single Oven + 30" Warming Drawer

Flush installation

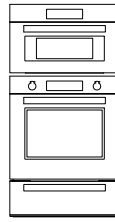

PROF30SOEX	PROF30FSEXT	PROF30WDEX
PROF30CSEX	PROF30FSE XV	MAST30WDEX
MAST30SOEX	MAST30FSEXT	
MAST30CSEX	MAST30FSE XV	

TOP VIEW

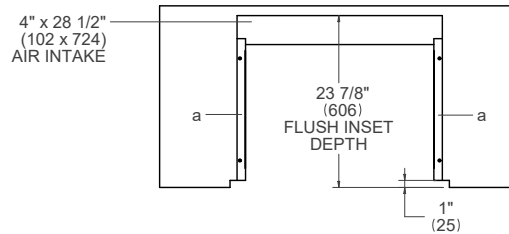

SIDE VIEW

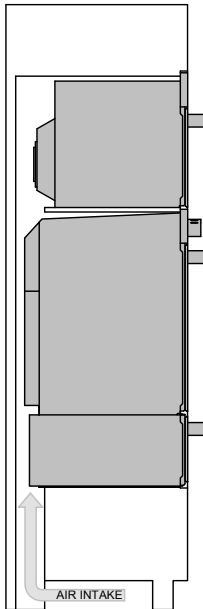

FRONT VIEW

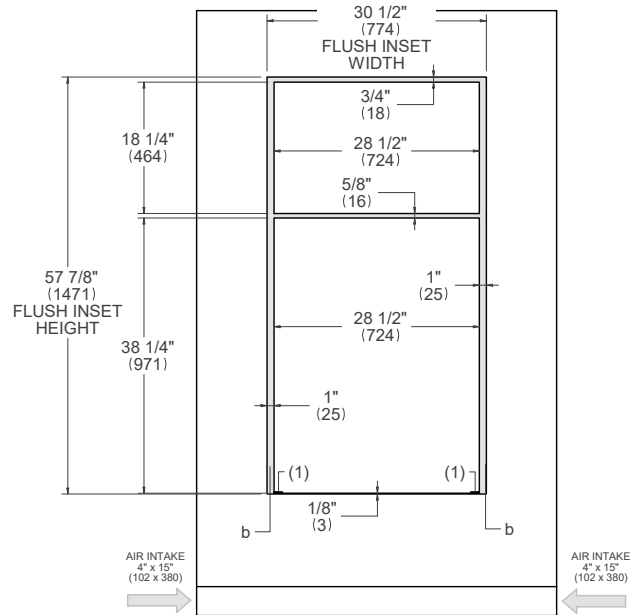

- (a) Spacers - Included with appliance
- (b) Visible Area - Match finish to outside cabinet panels

For electrical and gas supply please see single installation requirements. Placement within the opening may require additional cabinet depth.

30" Specialty Oven + 30" Convection Single Oven

Proud installation

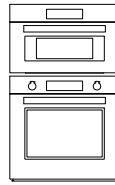

PROF30SOEX	PROF30FSEXT
PROF30CSEX	PROF30FSE XV
MAST30SOEX	MAST30FSEXT
MAST30CSEX	MAST30FSE XV

TOP VIEW

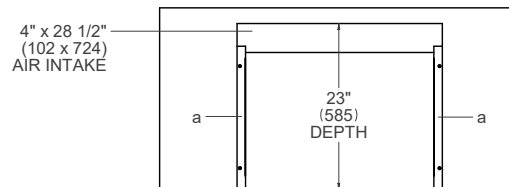

SIDE VIEW

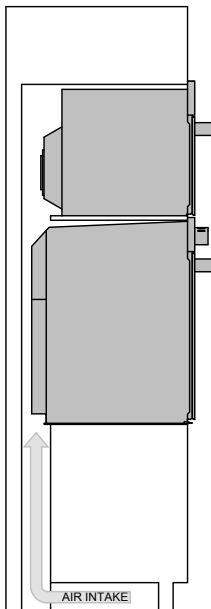

FRONT VIEW

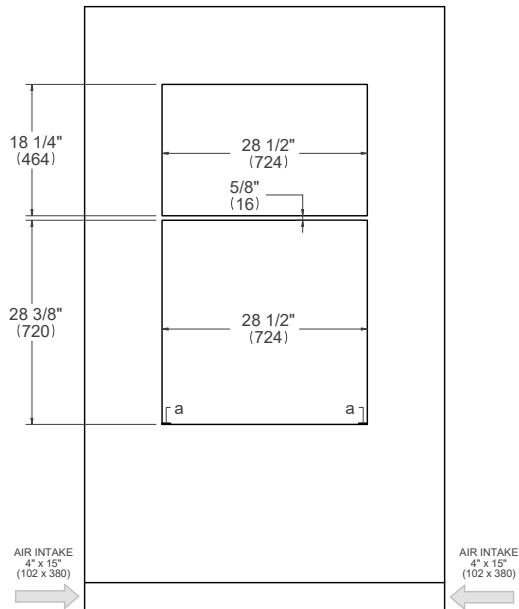

(a) Spacers - Included with appliance

For electrical and gas supply please see single installation requirements. Placement within the opening may require additional cabinet depth.

30" Specialty Oven + 30" Convection Single Oven

Flush installation

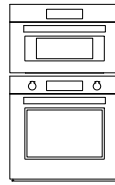

PROF30SOEX	PROF30FSEXT
PROF30CSEX	PROF30FSE XV
MAST30SOEX	MAST30FSEXT
MAST30CSEX	MAST30FSE XV

TOP VIEW

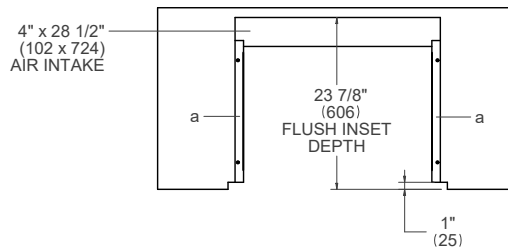

SIDE VIEW

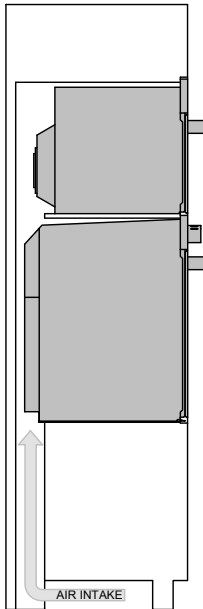

FRONT VIEW

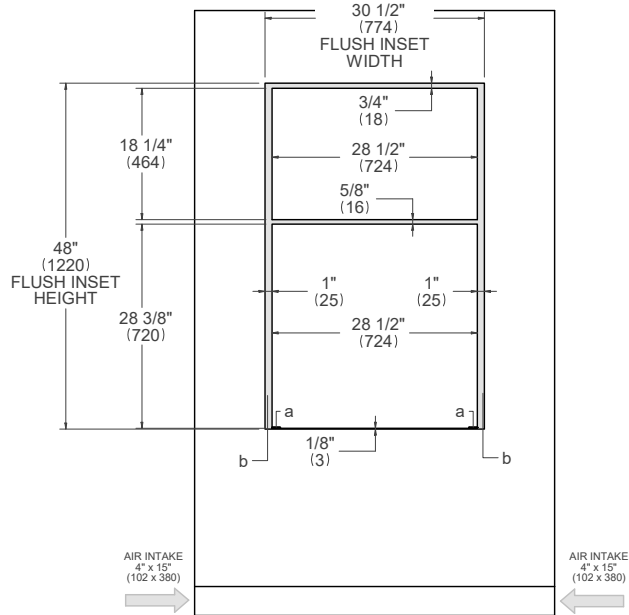

- (a) Spacers - Included with appliance
- (b) Visible Area - Match finish to outside cabinet panels

For electrical and gas supply please see single installation requirements. Placement within the opening may require additional cabinet depth.

30" Microwave + 30" Convection Single Oven

Proud installation

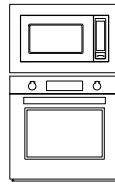

MO30STANE PROF30FSEXT
 PROF30FSEXV
 MAST30FSEXT
 MAST30FSEXV

TOP VIEW

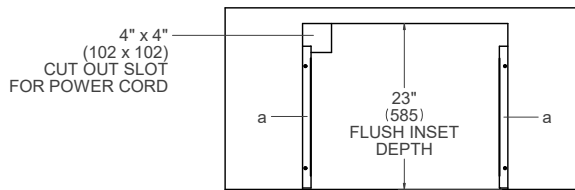

SIDE VIEW

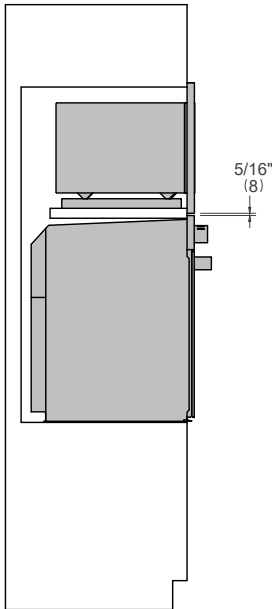

FRONT VIEW

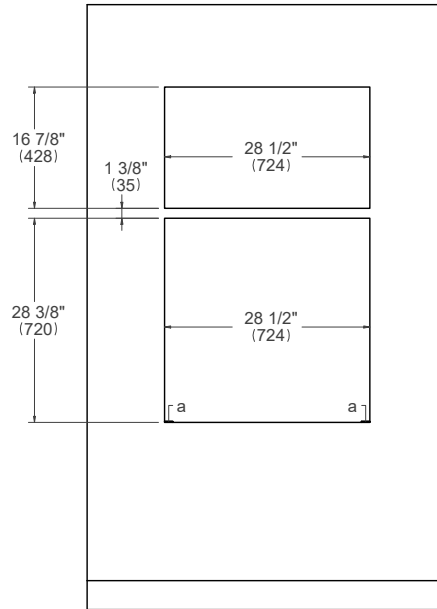

(a) Spacers - Included with appliance

For electrical and gas supply please see single installation requirements. Placement within the opening may require additional cabinet depth.

30" Microwave + 30" Convection Single Oven

Flush installation non vented

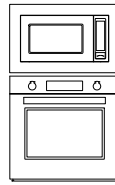

MO30STANE PROF30FSEXT
 PROF30FSEXV
 MAST30FSEXT
 MAST30FSEXV

TOP VIEW

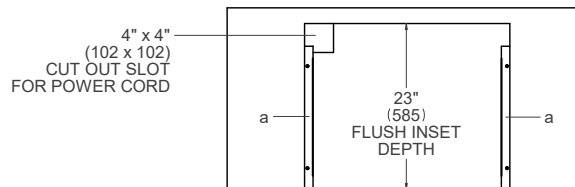

SIDE VIEW

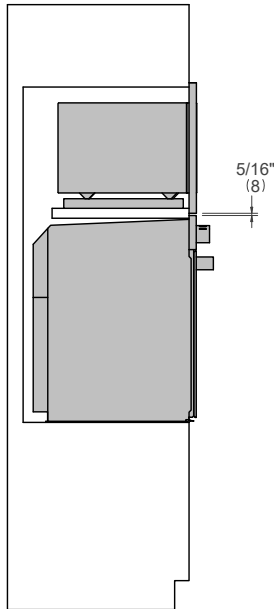

FRONT VIEW

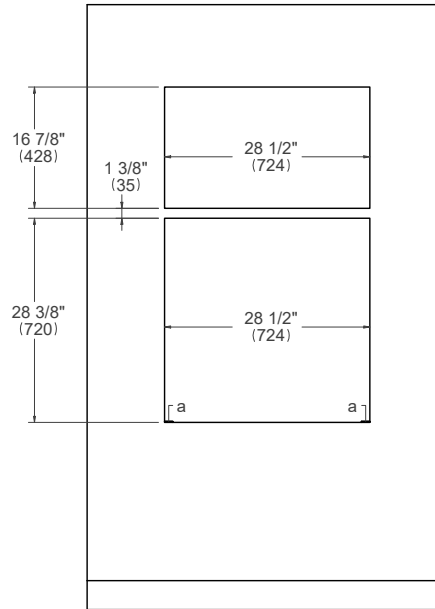

- (a) Spacers - Included with appliance
- (b) Visible Area - Match finish to outside cabinet panels

For electrical and gas supply please see single installation requirements. Placement within the opening may require additional cabinet depth.

30" Microwave + 30" Convection Single Oven

Flush installation vented

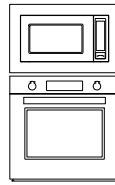

MO30STANE PROF30FSEXT
 PROF30FSE XV
 MAST30FSEXT
 MAST30FSE XV

TOP VIEW

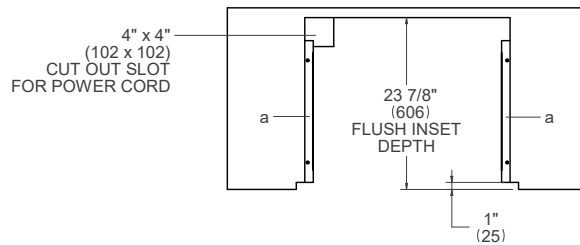

SIDE VIEW

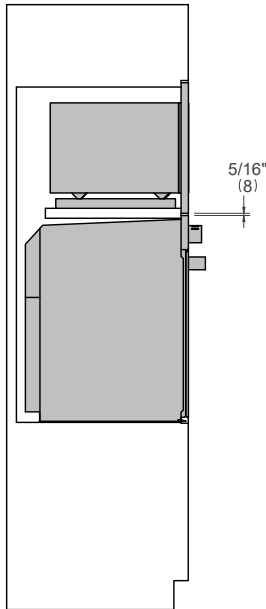

FRONT VIEW

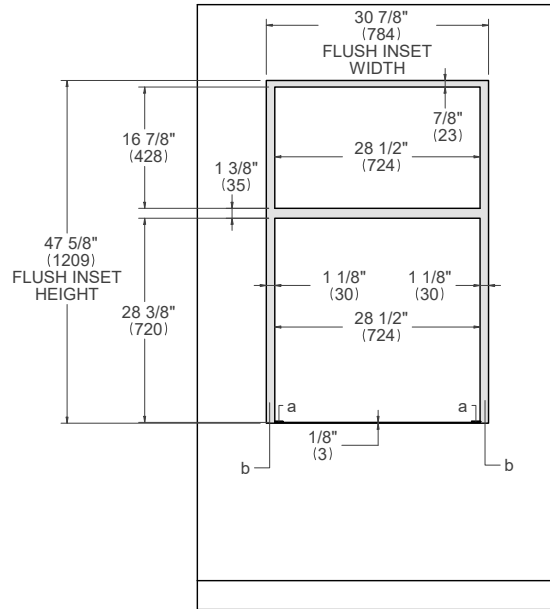

- (a) Spacers - Included with appliance
- (b) Visible Area - Match finish to outside cabinet panels

For electrical and gas supply please see single installation requirements. Placement within the opening may require additional cabinet depth.

30" Convection Single Oven + 30" Warming Drawer

Proud installation

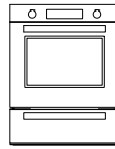

PROF30FSEXT PROF30WDEX
 PROF30FSEXV MAST30WDEX
 MAST30FSEXT
 MAST30FSEXV

TOP VIEW

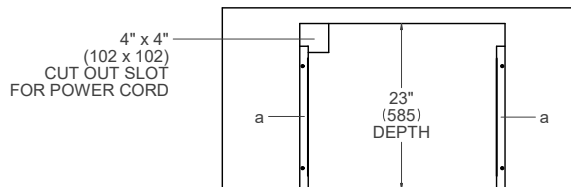

SIDE VIEW

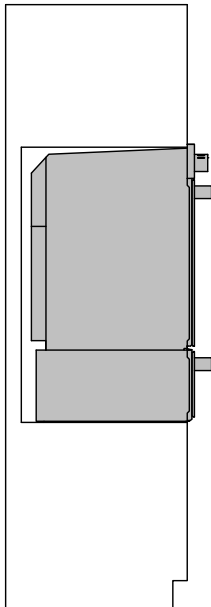

FRONT VIEW

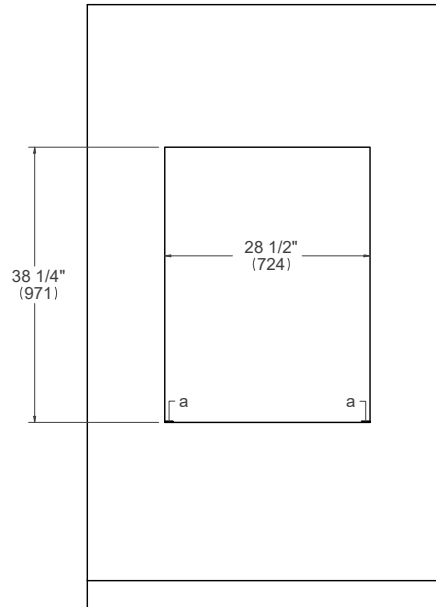

(a) Spacers - Included with appliance

For electrical and gas supply please see single installation requirements. Placement within the opening may require additional cabinet depth.

30" Convection Single Oven + 30" Warming Drawer

Flush installation non vented

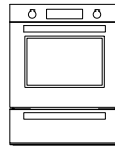

PROF30FSEXT PROF30WDEX
 PROF30FSEXV MAST30WDEX
 MAST30FSEXT
 MAST30FSEXV

TOP VIEW

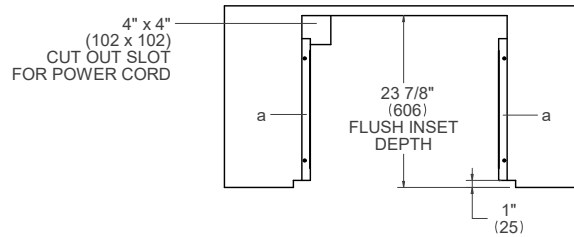

SIDE VIEW

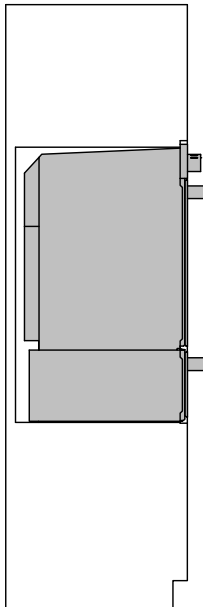

FRONT VIEW

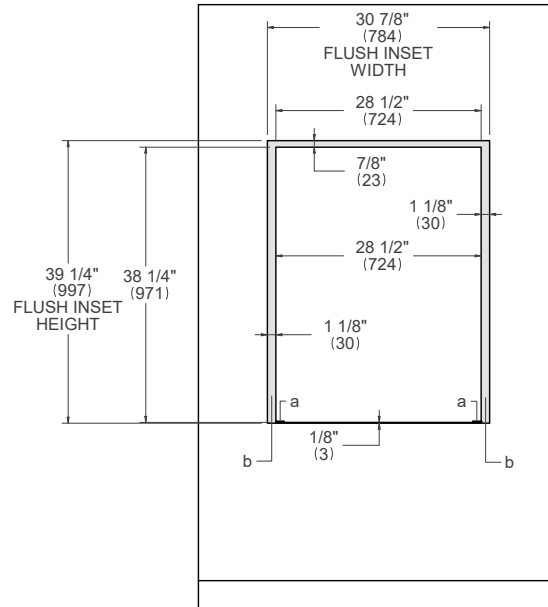

- (a) Spacers - Included with appliance
- (b) Visible Area - Match finish to outside cabinet panels

For electrical and gas supply please see single installation requirements. Placement within the opening may require additional cabinet depth.

30" Convection Single Oven + 30" Warming Drawer

Flush installation vented

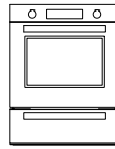

PROF30FSEXT PROF30WDEX
 PROF30FSEXV MAST30WDEX
 MAST30FSEXT
 MAST30FSEXV

TOP VIEW

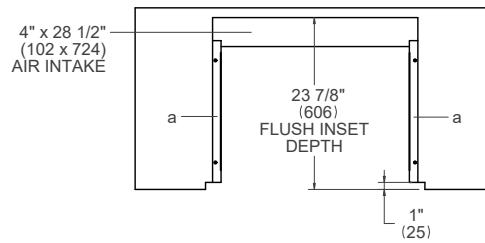

SIDE VIEW

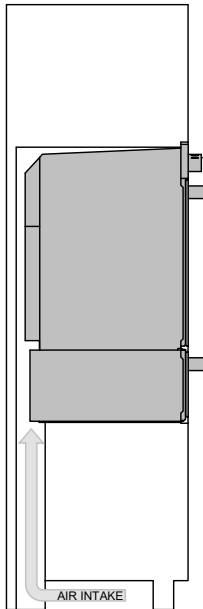

FRONT VIEW

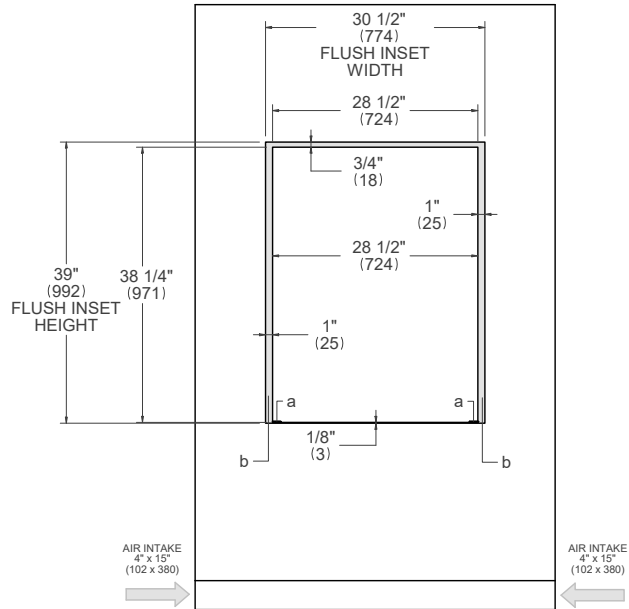

- (a) Spacers - Included with appliance
- (b) Visible Area - Match finish to outside cabinet panels

For electrical and gas supply please see single installation requirements. Placement within the opening may require additional cabinet depth.

30" Convection Double Oven + 30" Warming Drawer

Proud installation

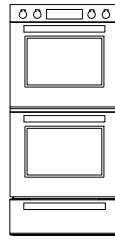

PROF30FDEXT PROF30WDEX
 PROF30FDEXV MAST30WDEX
 MAST30FDEXT
 MAST30FDEXV

TOP VIEW

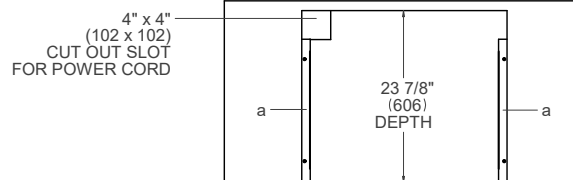

SIDE VIEW

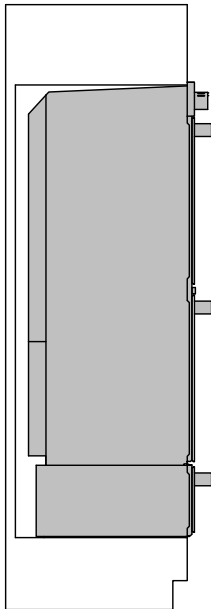

FRONT VIEW

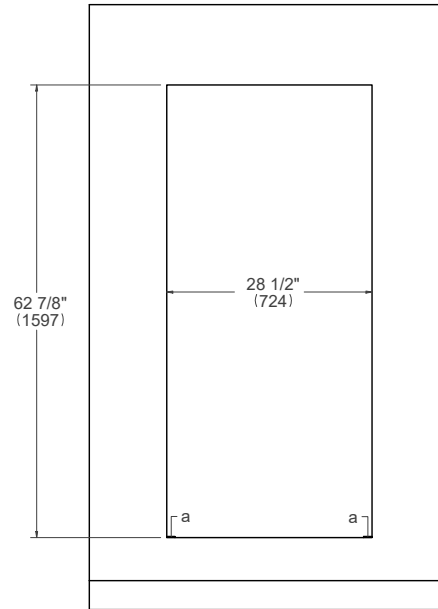

(a) Spacers - Parts of standard equipment

For electrical and gas supply please see single installation requirements. Placement within the opening may require additional cabinet depth.

30" Convection Double Oven + 30" Warming Drawer

Flush installation

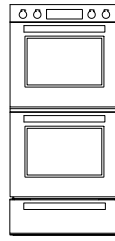

- PROF30FDEXT PROF30WDEX
- PROF30FDEXV MAST30WDEX
- MAST30FDEXT
- MAST30FDEXV

TOP VIEW

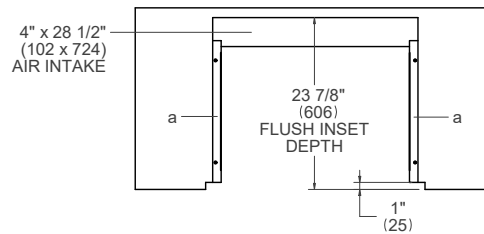

SIDE VIEW

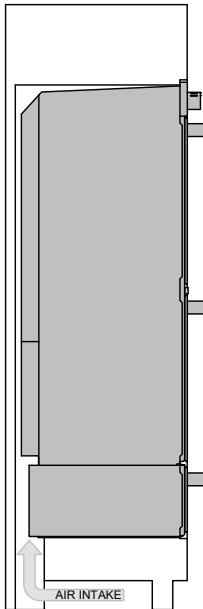

FRONT VIEW

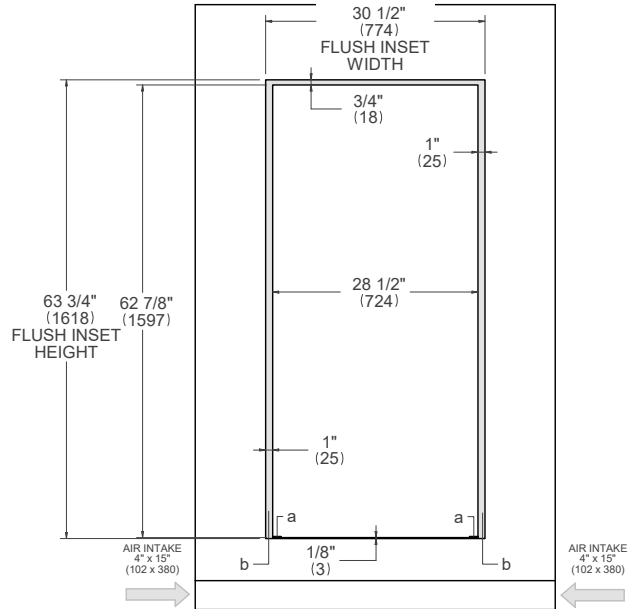

- (a) Spacers - Included with appliance
- (b) Visible Area - Match finish to outside cabinet panels

For electrical and gas supply please see single installation requirements. Placement within the opening may require additional cabinet depth.

24" Specialty Oven + 24" Convection Single Oven

Proud installation



PROF24SOEX
PROF24FSEXV

TOP VIEW

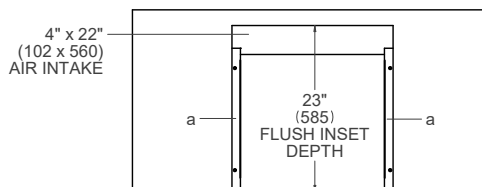

SIDE VIEW

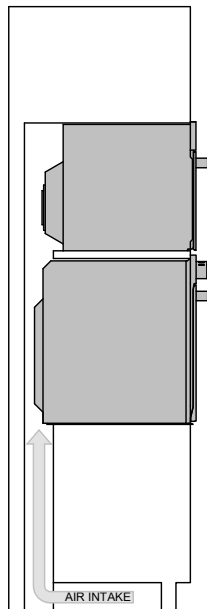

FRONT VIEW

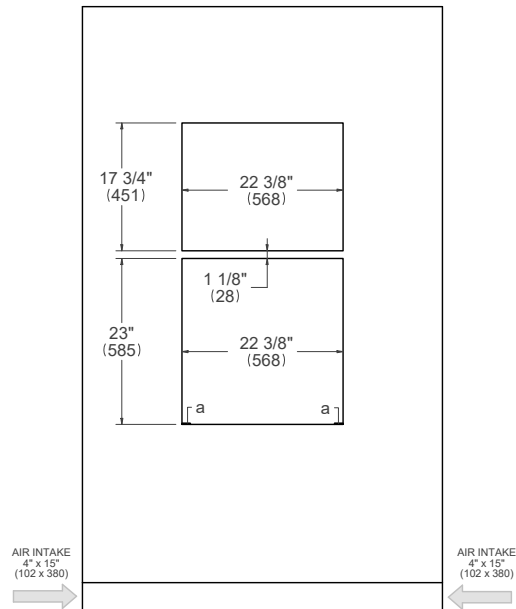

(a) Spacers - Included with appliance

For electrical and gas supply please see single installation requirements. Placement within the opening may require additional cabinet depth.

24" Specialty Oven + 24" Convection Single Oven

Flush installation

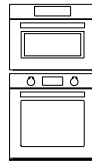

PROF24SOEX
PROF24FSEXV

TOP VIEW

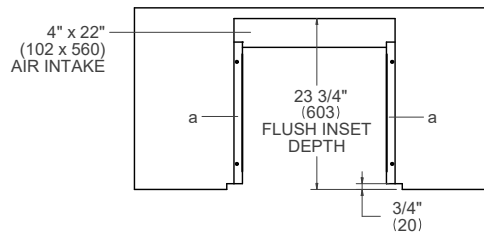

SIDE VIEW

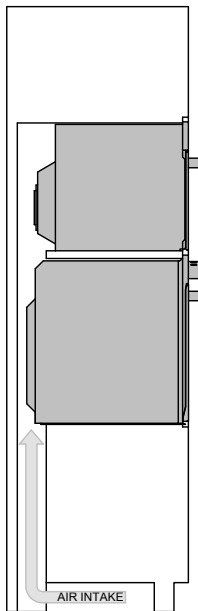

FRONT VIEW

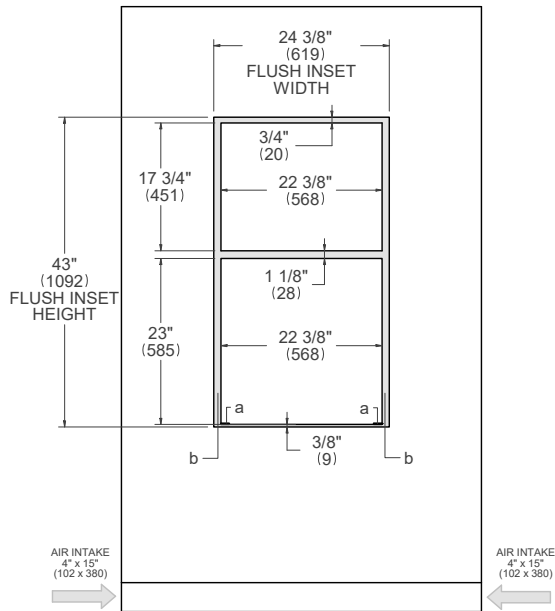

- (a) Spacers - Included with appliance
- (b) Visible Area - Match finish to outside cabinet panels

For electrical and gas supply please see single installation requirements. Placement within the opening may require additional cabinet depth.

Side by Side 30" Convection Single Oven + 30" Specialty Oven + 30" Warming Drawer Proud installation

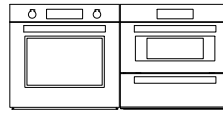

PROF30SOEX	PROF30FSEXT	PROF30WDEX
PROF30CSEX	PROF30FSE XV	MAST30WDEX
MAST30SOEX	MAST30FSEXT	
MAST30CSEX	MAST30FSE XV	

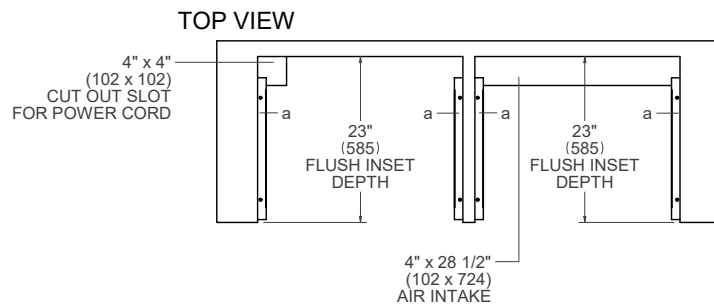

LEFT CABINET VIEW

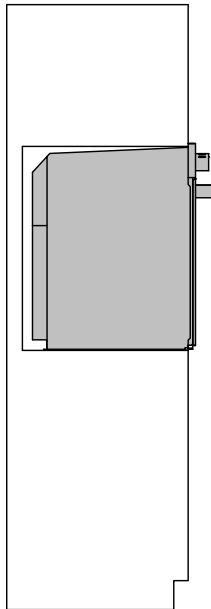

RIGHT CABINET VIEW

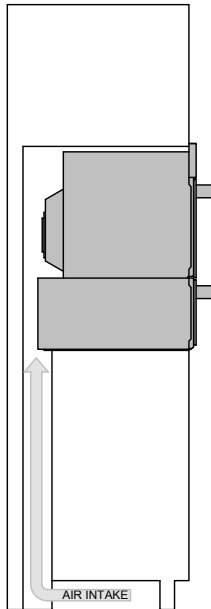

FRONT VIEW

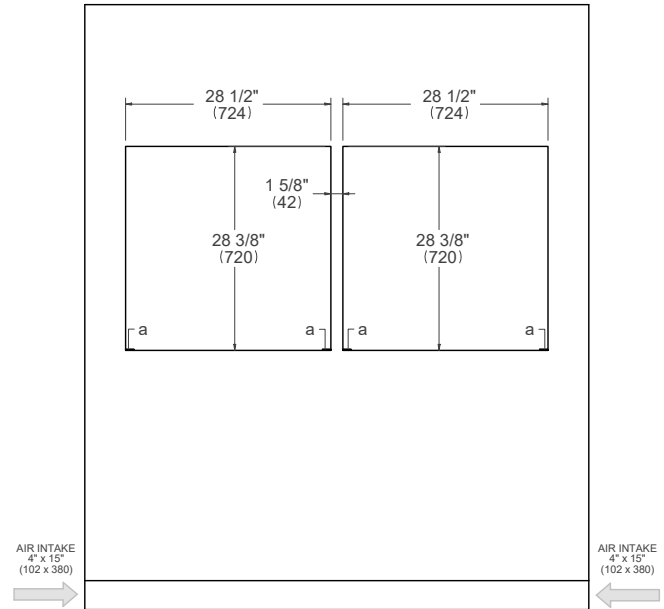

(a) Spacers - Included with appliance

For electrical and gas supply please see single installation requirements. Placement within the opening may require additional cabinet depth.

Side by Side 30" Convection Single Oven + 30" Specialty Oven + 30" Warming Drawer Flush installation

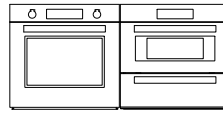

PROF30SOEX	PROF30FSEXT	PROF30WDEX
PROF30CSEX	PROF30FSE XV	MAST30WDEX
MAST30SOEX	MAST30FSEXT	
MAST30CSEX	MAST30FSE XV	

TOP VIEW

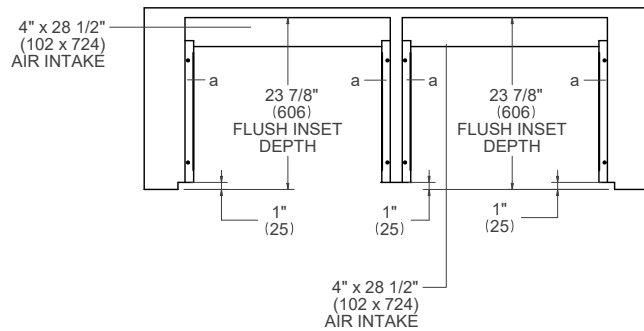

LEFT CABINET VIEW

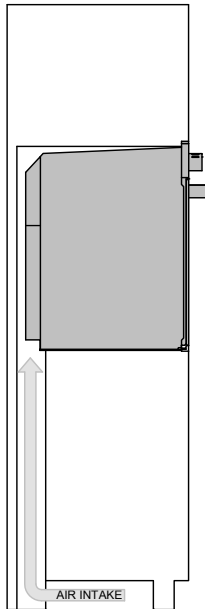

RIGHT CABINET VIEW

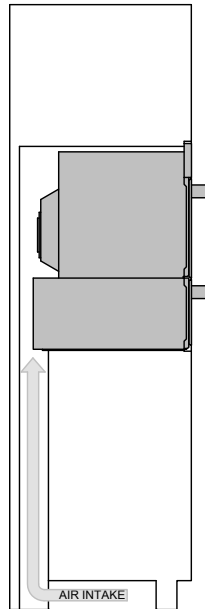

FRONT VIEW

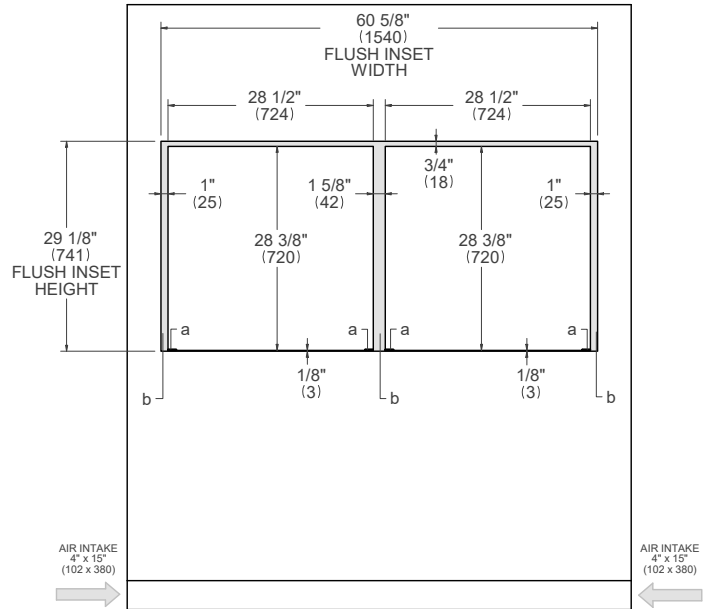

- (a) Spacers - Included with appliance
- (b) Visible Area - Match finish to outside cabinet panels

For electrical and gas supply please see single installation requirements. Placement within the opening may require additional cabinet depth.

30" Convection Oven + 36" Drop-in Cooktop

Flush installation non vented

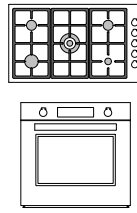

PROF366QBXT MAST366QBXT PROF30FSEXT MAST30FSEXT
 PROF365QBXT MAST365QBXT PROF30FSEXV MAST30FSEXV
 PROF365QXE MAST365QXE

TOP VIEW – COOKTOP DETAIL

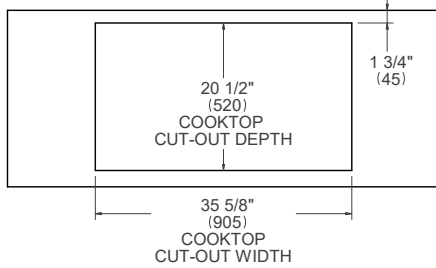

TOP VIEW – OVEN DETAIL

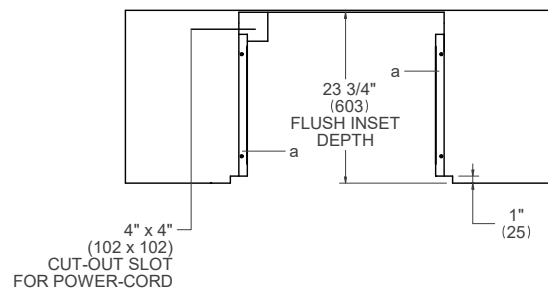

SIDE VIEW

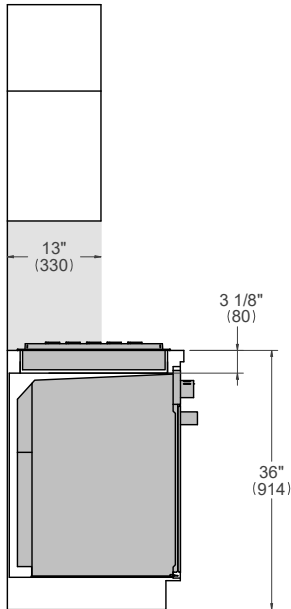

FRONT VIEW

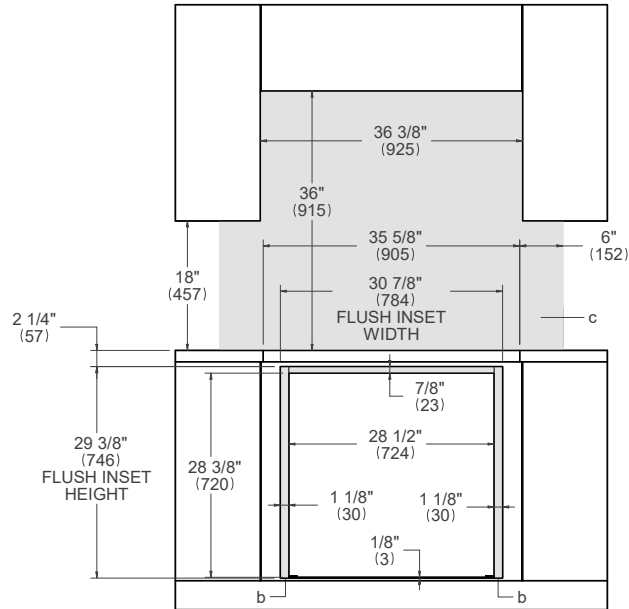

- (a) Spacers - Included with appliance
- (b) Visible Area - Match finish to outside cabinet panels
- (c) Combustible material cannot be installed within shaded area

For electrical and gas supply please see single installation requirements. Placement within the opening may require additional cabinet depth.

30" Convection Oven + 36" Drop-in Cooktop

Flush installation vented

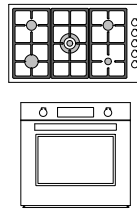

PROF366QBXT MAST366QBXT PROF30FSEXT MAST30FSEXT
 PROF365QBXT MAST365QBXT PROF30FSEXV MAST30FSEXV
 PROF365QXE MAST365QXE

TOP VIEW – COOKTOP DETAIL

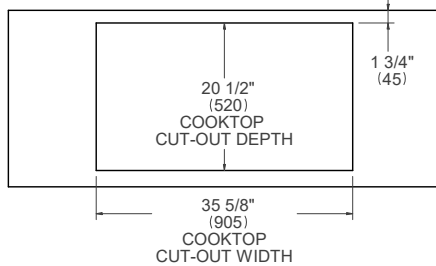

TOP VIEW – OVEN DETAIL

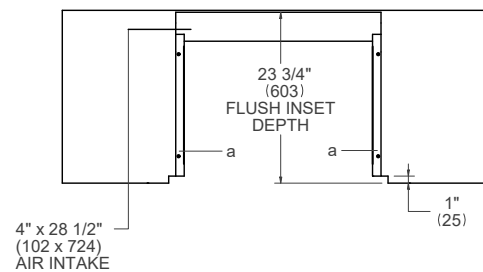

SIDE VIEW

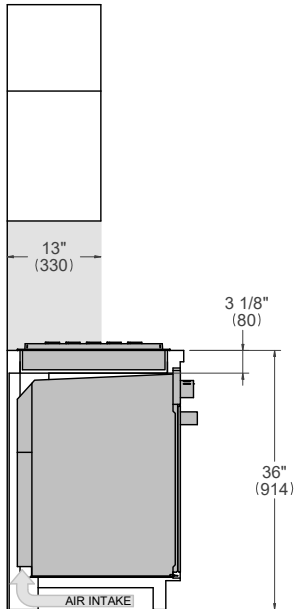

FRONT VIEW

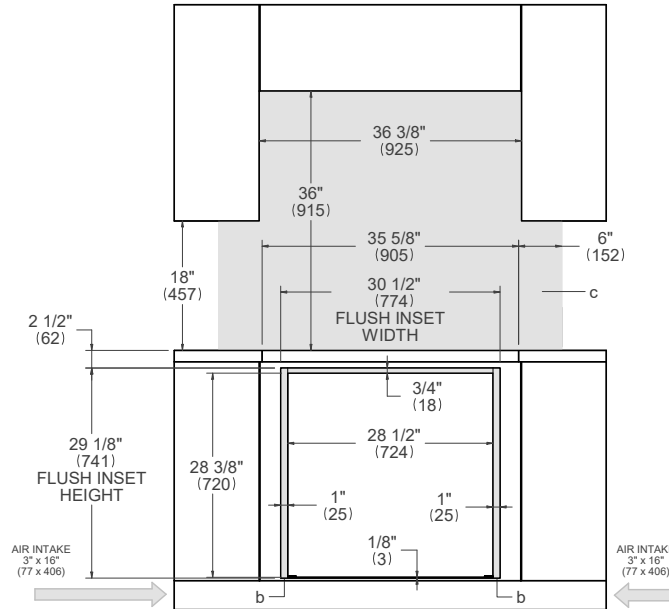

- (a) Spacers - Included with appliance
- (b) Visible Area - Match finish to outside cabinet panels
- (c) Combustible material cannot be installed within shaded area

For electrical and gas supply please see single installation requirements. Placement within the opening may require additional cabinet depth.

30" Convection Oven + 30" Drop-in Cooktop

Flush installation non vented

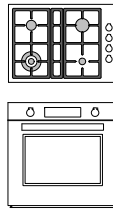

PRO304QBXT PROF30FSEXT MAST30FSEXT
 PROF304QXE PROF30FSEXTV MAST30FSEXTV
 MAST304QBXT
 MAST304QXE

TOP VIEW – COOKTOP DETAIL

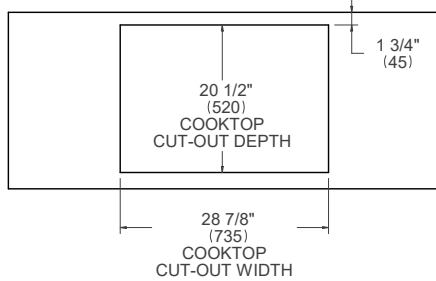

TOP VIEW – OVEN DETAIL

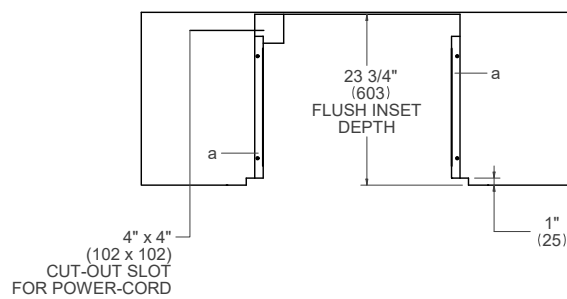

SIDE VIEW

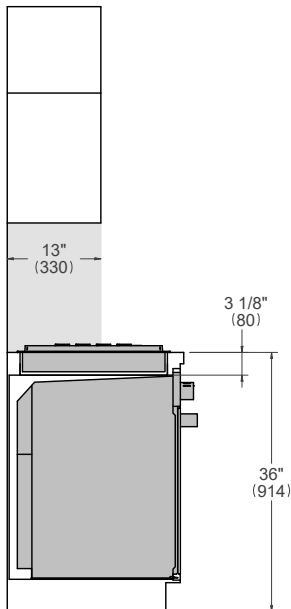

FRONT VIEW

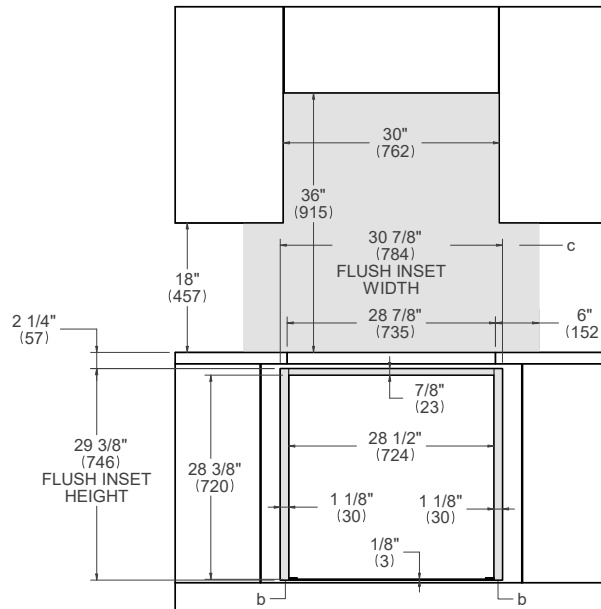

- (a) Spacers - Included with appliance
- (b) Visible Area - Match finish to outside cabinet panels
- (c) Combustible material cannot be installed within shaded area

For electrical and gas supply please see single installation requirements. Placement within the opening may require additional cabinet depth.

30" Convection Oven + 30" Drop-in Cooktop

Flush installation vented

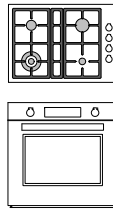

PRO304QBXT PROF30FSEXT MAST30FSEXT
 PROF304QXE PROF30FSEXTV MAST30FSEXTV
 MAST304QBXT
 MAST304QXE

TOP VIEW – COOKTOP DETAIL

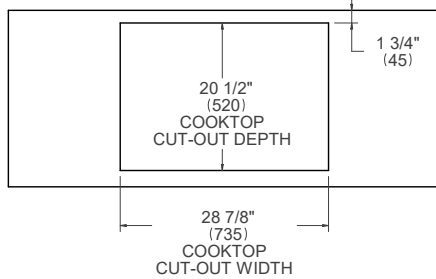

TOP VIEW – OVEN DETAIL

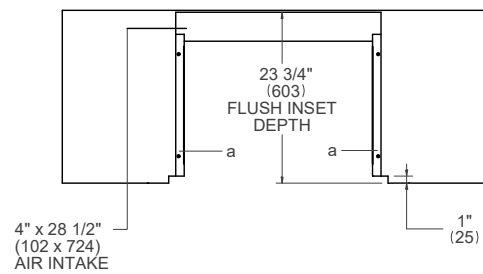

SIDE VIEW

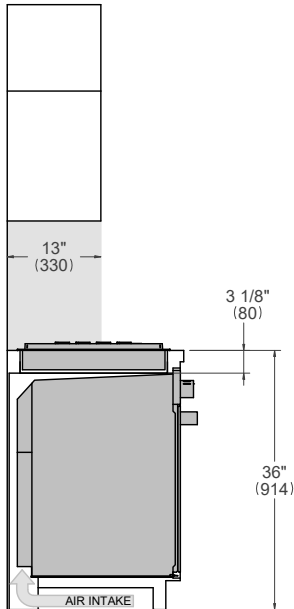

FRONT VIEW

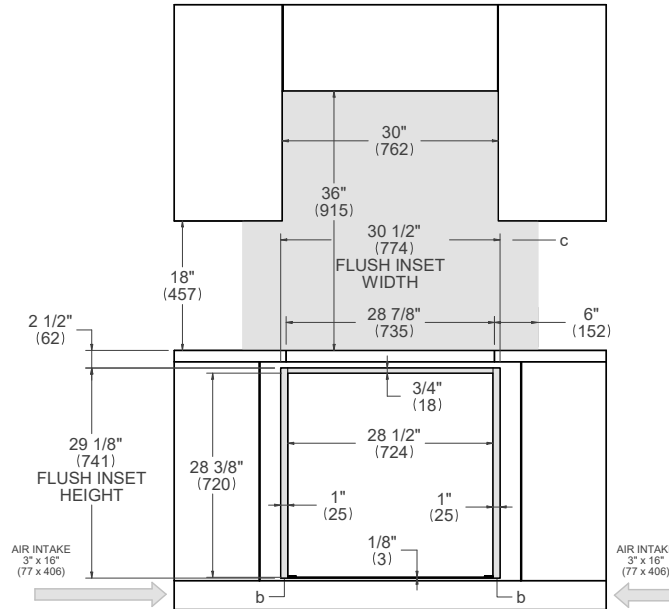

- (a) Spacers - Included with appliance
- (b) Visible Area - Match finish to outside cabinet panels
- (c) Combustible material cannot be installed within shaded area

For electrical and gas supply please see single installation requirements. Placement within the opening may require additional cabinet depth.

30" Convection Oven + 36" Cooktop XV

Flush installation non vented

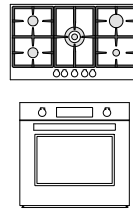

PROF365CTV PROF30FSEXT MAST30FSEXT
 PROF30FSEXV MAST30FSEXV

TOP VIEW – COOKTOP DETAIL

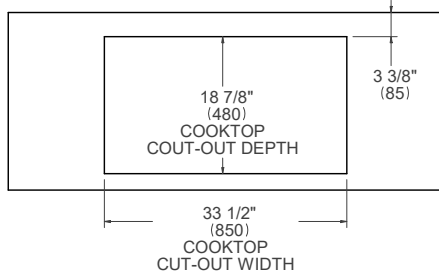

TOP VIEW – OVEN DETAIL

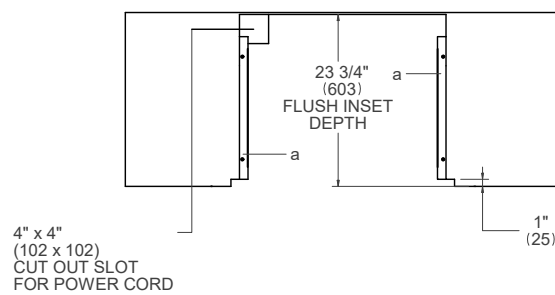

SIDE VIEW

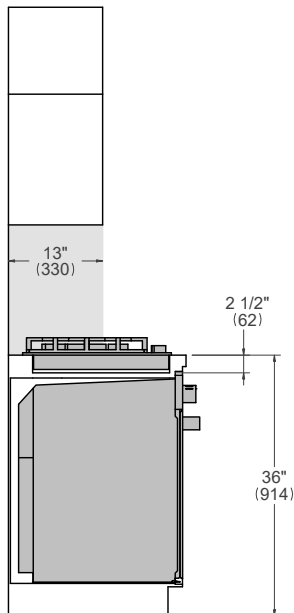

FRONT VIEW

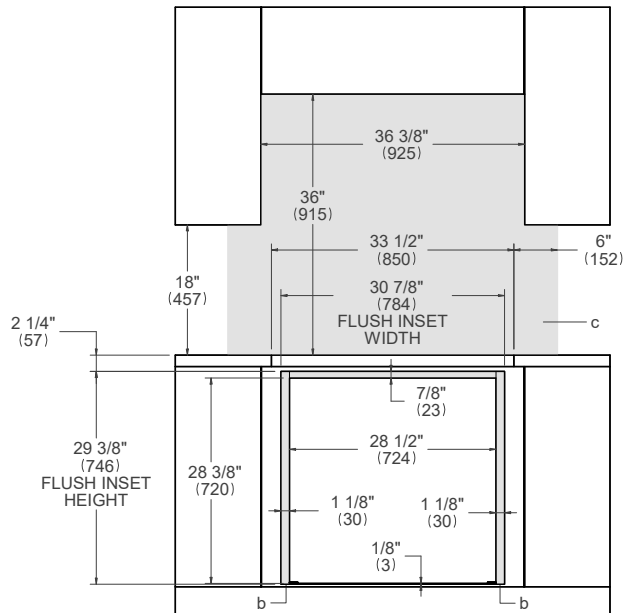

- (a) Spacers - Included with appliance
- (b) Visible Area - Match finish to outside cabinet panels
- (c) Combustible material cannot be installed within shaded area

For electrical and gas supply please see single installation requirements. Placement within the opening may require additional cabinet depth.

30" Convection Oven + 36" Cooktop XV

Flush installation vented

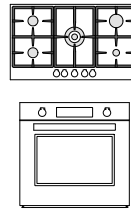

PROF365CTV PROF30FSEXT MAST30FSEXT
 PROF30FSEXV MAST30FSEXV

TOP VIEW – COOKTOP DETAIL

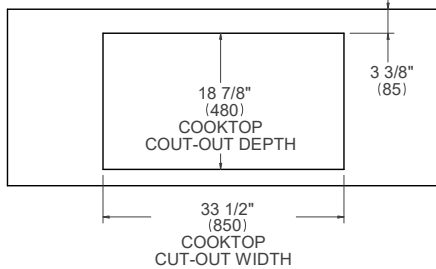

TOP VIEW – OVEN DETAIL

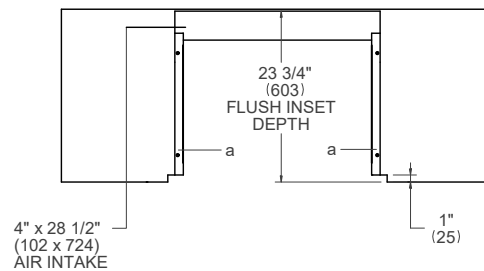

SIDE VIEW

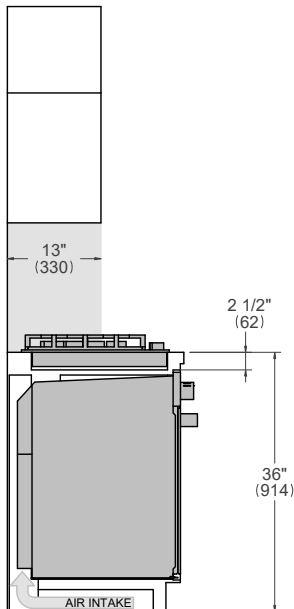

FRONT VIEW

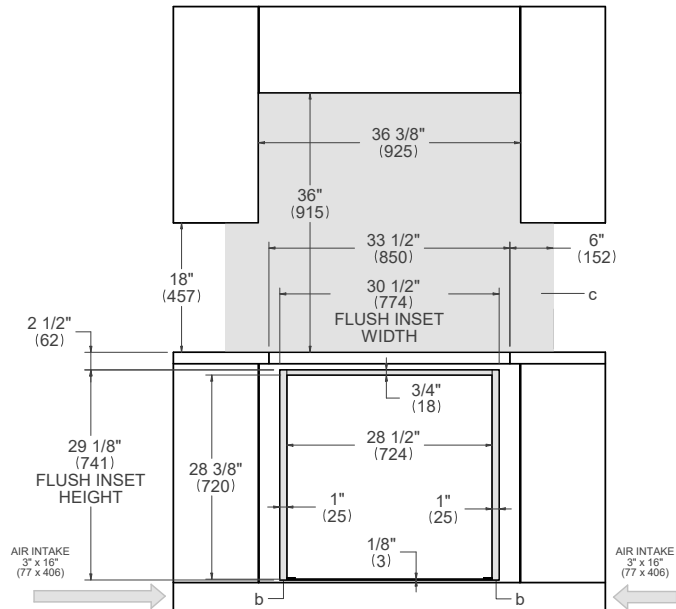

- (a) Spacers - Included with appliance
- (b) Visible Area - Match finish to outside cabinet panels
- (c) Combustible material cannot be installed within shaded area

For electrical and gas supply please see single installation requirements. Placement within the opening may require additional cabinet depth.

30" Convection Oven + 30" Cooktop XV

Flush installation non vented

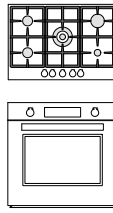

PROF305CTXV PROF30FSEXT MAST30FSEXT
 PROF30FSEXV MAST30FSEXV

TOP VIEW – COOKTOP DETAIL

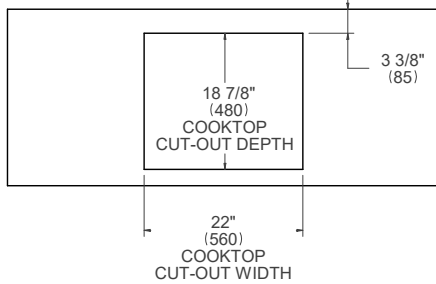

TOP VIEW – OVEN DETAIL

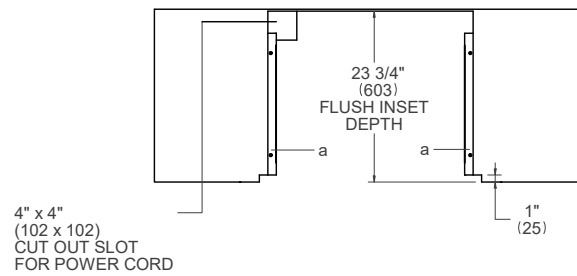

SIDE VIEW

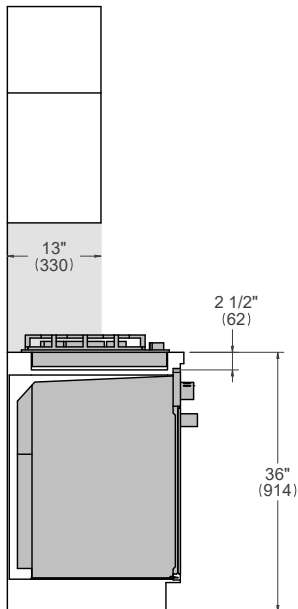

FRONT VIEW

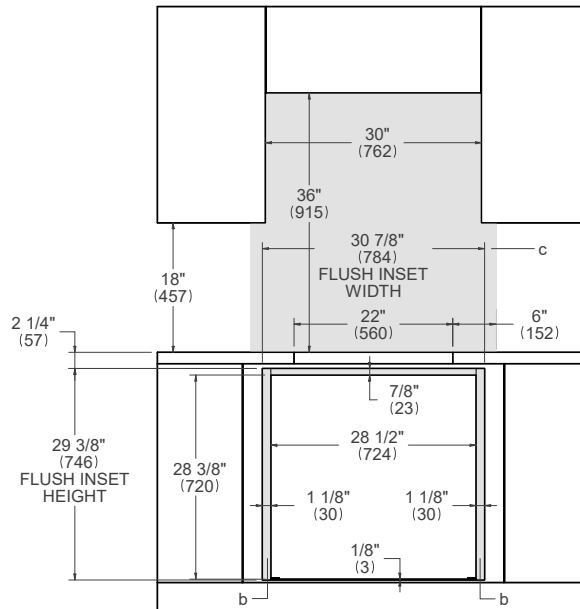

- (a) Spacers - Included with appliance
- (b) Visible Area - Match finish to outside cabinet panels
- (c) Combustible material cannot be installed within shaded area

For electrical and gas supply please see single installation requirements. Placement within the opening may require additional cabinet depth.

30" Convection Oven + 30" Cooktop XV

Flush installation vented

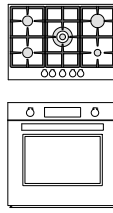

PROF305CTXV PROF30FSEXT MAST30FSEXT
 PROF30FSEXV MAST30FSEXV

TOP VIEW – COOKTOP DETAIL

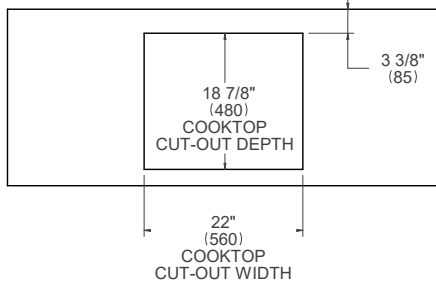

TOP VIEW – OVEN DETAIL

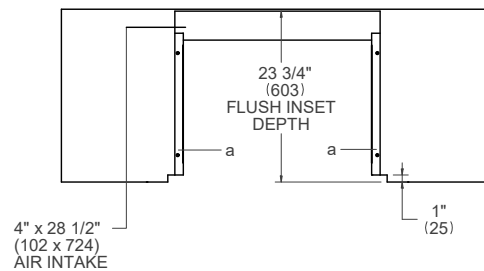

SIDE VIEW

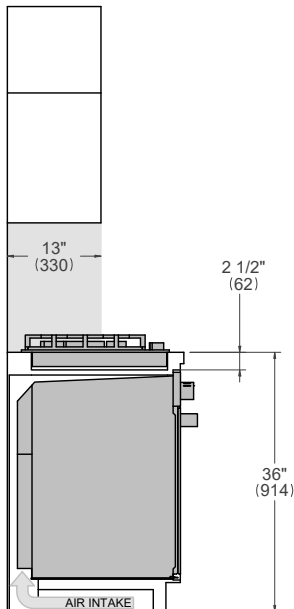

FRONT VIEW

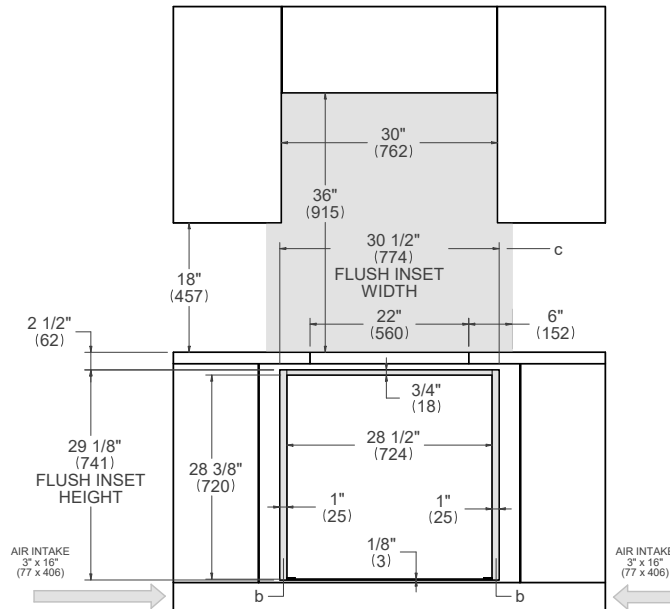

- (a) Spacers - Included with appliance
- (b) Visible Area - Match finish to outside cabinet panels
- (c) Combustible material cannot be installed within shaded area

For electrical and gas supply please see single installation requirements. Placement within the opening may require additional cabinet depth.

30" Convection Oven + 36" Induction Cooktop

Flush installation non vented

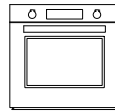
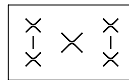

P365IAE PROF30FSEXT MAST30FSEXT
 PROF30FSE XV MAST30FSE XV

TOP VIEW – COOKTOP DETAIL

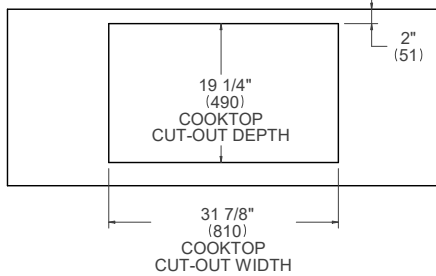

TOP VIEW – OVEN DETAIL

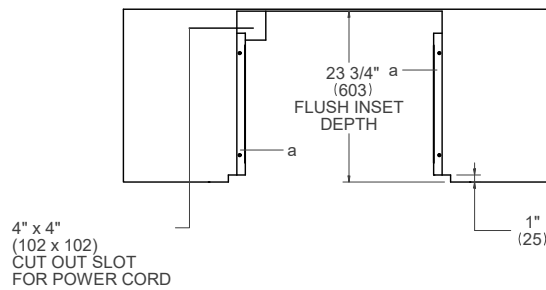

SIDE VIEW

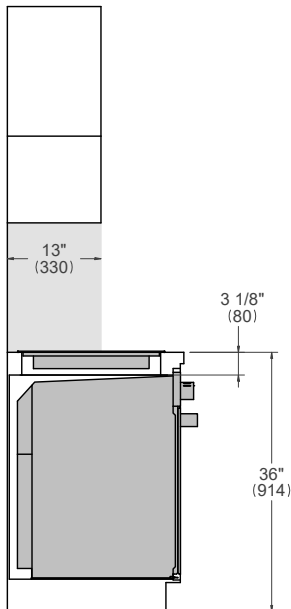

FRONT VIEW

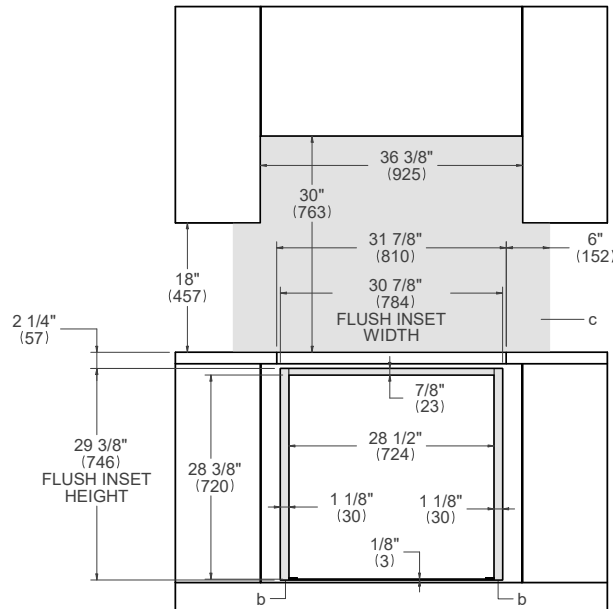

- (a) Spacers - Included with appliance
- (b) Visible Area - Match finish to outside cabinet panels
- (c) Combustible material cannot be installed within shaded area

For electrical and gas supply please see single installation requirements. Placement within the opening may require additional cabinet depth.

30" Convection Oven + 36" Induction Cooktop

Flush installation vented

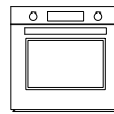
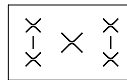

P365IAE PROF30FSEXT MAST30FSEXT
 PROF30FSE XV MAST30FSE XV

TOP VIEW – COOKTOP DETAIL

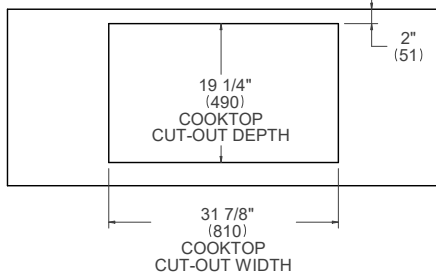

TOP VIEW – OVEN DETAIL

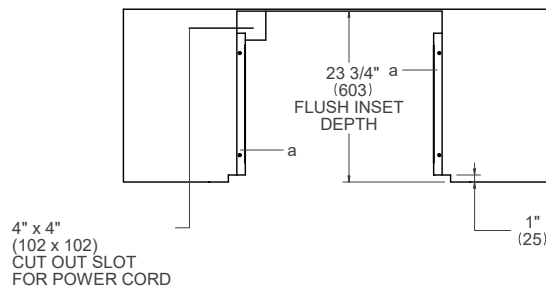

SIDE VIEW

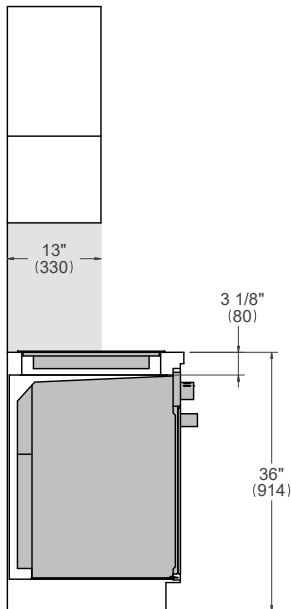

FRONT VIEW

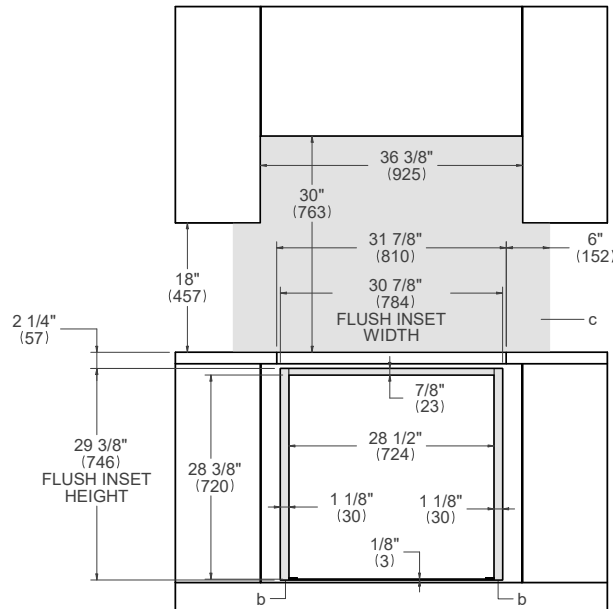

- (a) Spacers - Included with appliance
- (b) Visible Area - Match finish to outside cabinet panels
- (c) Combustible material cannot be installed within shaded area

For electrical and gas supply please see single installation requirements. Placement within the opening may require additional cabinet depth.

30" Convection Oven + 30" Induction Cooktop

Flush installation non vented

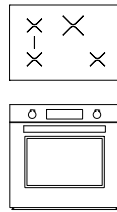

P304IAE PROF30FSEXT MAST30FSEXT
 PROF30FSE XV MAST30FSE XV

TOP VIEW – COOKTOP DETAIL

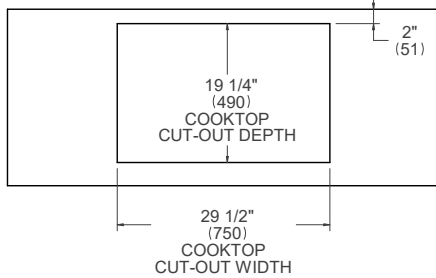

TOP VIEW – OVEN DETAIL

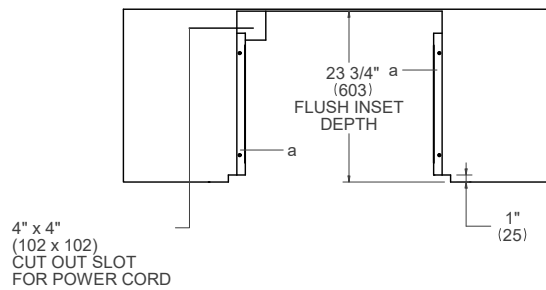

SIDE VIEW

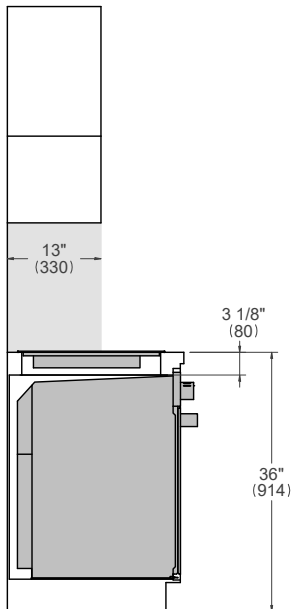

FRONT VIEW

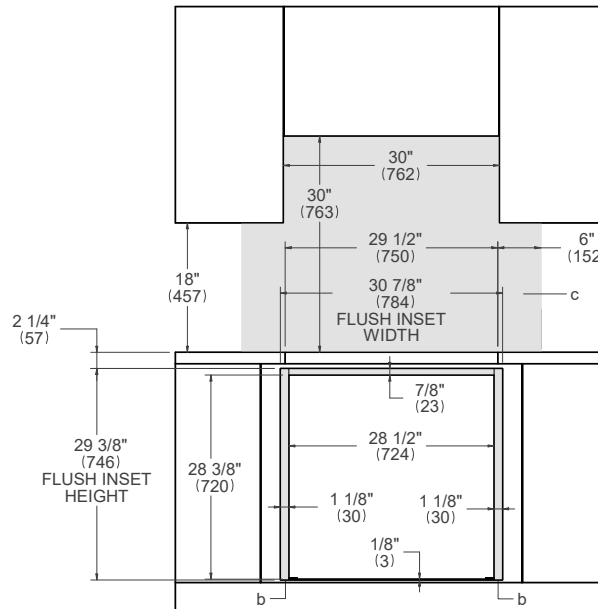

- (a) Spacers - Included with appliance
- (b) Visible Area - Match finish to outside cabinet panels
- (c) Combustible material cannot be installed within shaded area

For electrical and gas supply please see single installation requirements. Placement within the opening may require additional cabinet depth.

30" Convection Oven + 30" Induction Cooktop

Flush installation vented

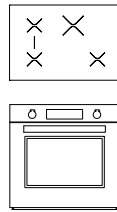

P304IAE PROF30FSEXT MAST30FSEXT
 PROF30FSEXV MAST30FSEXV

TOP VIEW – COOKTOP DETAIL

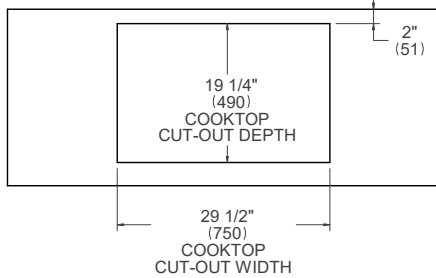

TOP VIEW – OVEN DETAIL

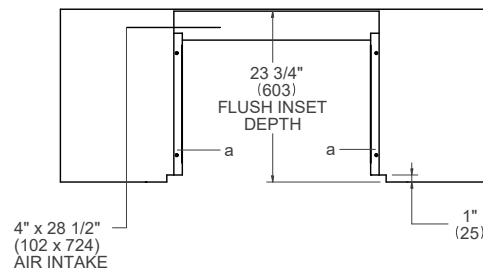

SIDE VIEW

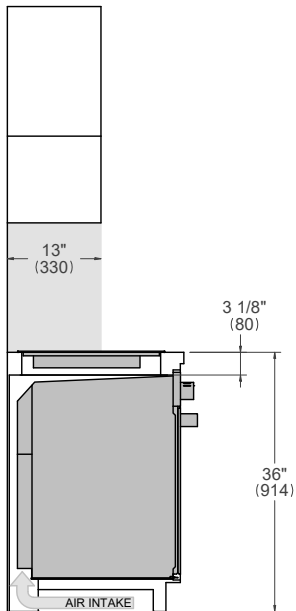

FRONT VIEW

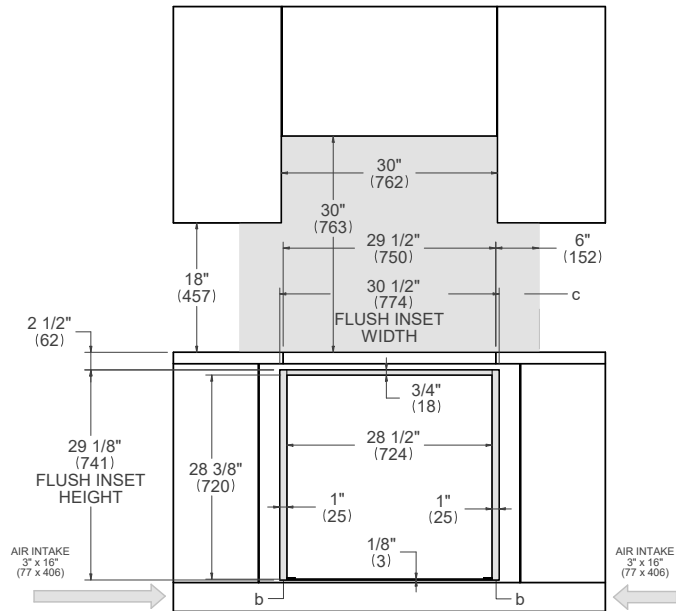

- (a) Spacers - Included with appliance
- (b) Visible Area - Match finish to outside cabinet panels
- (c) Combustible material cannot be installed within shaded area

For electrical and gas supply please see single installation requirements. Placement within the opening may require additional cabinet depth.

30" Convection Oven + 30" Electric Ceramic Cooktop

Flush installation vented

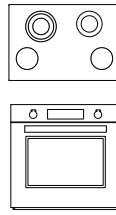

PE304CER PROF30FSEXT MAST30FSEXT
 PROF30FSEXV MAST30FSEXV

TOP VIEW – COOKTOP DETAIL

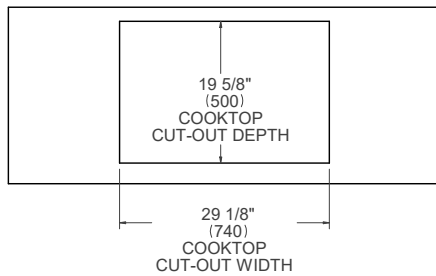

TOP VIEW – OVEN DETAIL

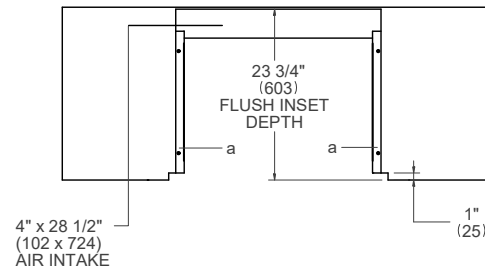

SIDE VIEW

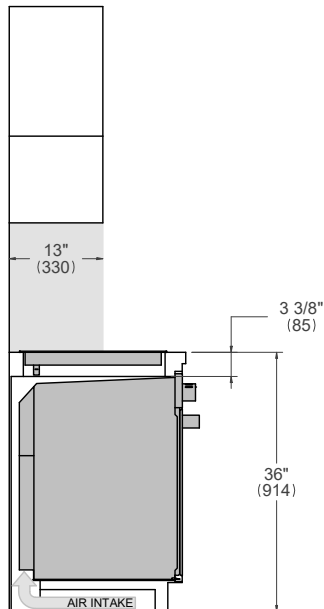

FRONT VIEW

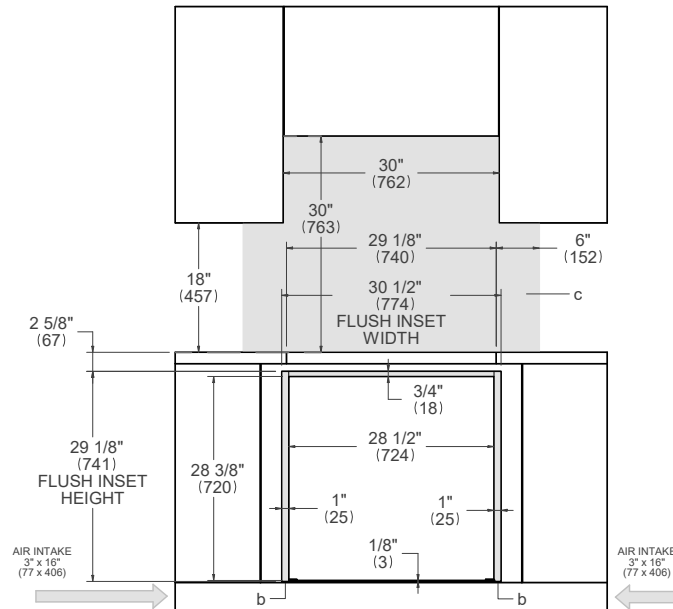

- (a) Spacers - Included with appliance
- (b) Visible Area - Match finish to outside cabinet panels
- (c) Combustible material cannot be installed within shaded area

For electrical and gas supply please see single installation requirements. Placement within the opening may require additional cabinet depth.

30" Specialty Oven + 36" Drop-in Cooktop

Flush installation

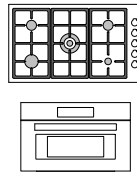

PROF30SOEX	PROF366QBXT	MAST366QBXT
PROF30CSEX	PROF365QBXT	MAST365QBXT
MAST30SOEX	PRO365QXE	MAST365QXE
MAST30CSEX		

TOP VIEW – COOKTOP DETAIL

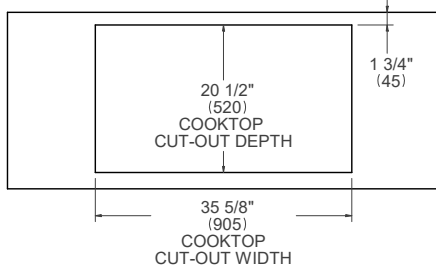

TOP VIEW – OVEN DETAIL

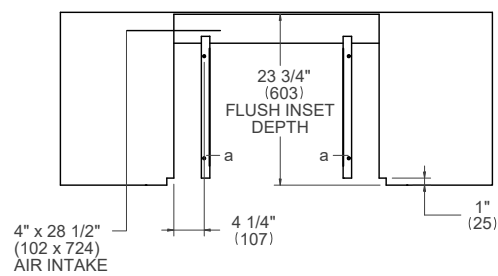

SIDE VIEW

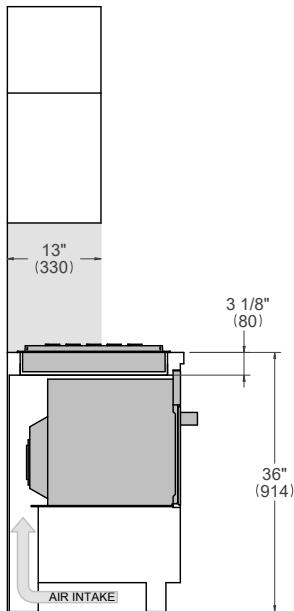

FRONT VIEW

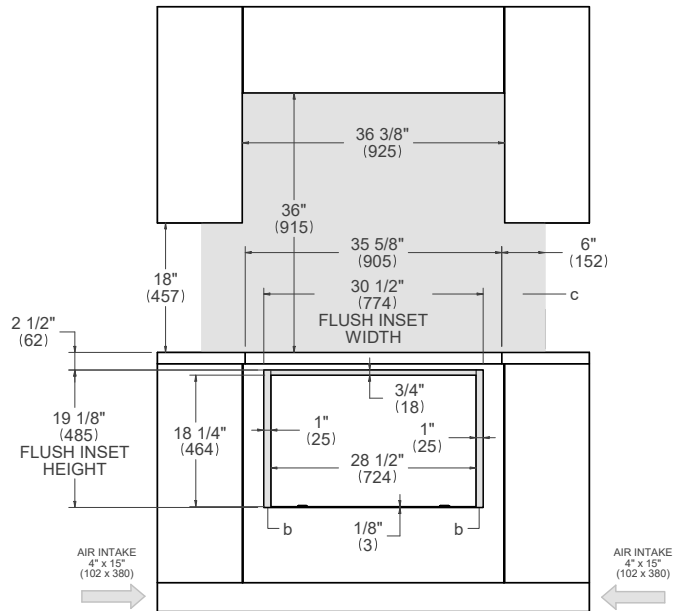

- (a) Spacers - Included with appliance
- (b) Visible Area - Match finish to outside cabinet panels
- (c) Combustible material cannot be installed within shaded area

For electrical and gas supply please see single installation requirements. Placement within the opening may require additional cabinet depth.

30" Specialty Oven + 30" Drop-in Cooktop

Flush installation

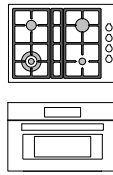

PROF30SOEX	PROF304QBXT
PROF30CSEX	PROF304QXE
MAST30SOEX	MAST304QBXT
MAST30CSEX	MAST304QBXE

TOP VIEW – COOKTOP DETAIL

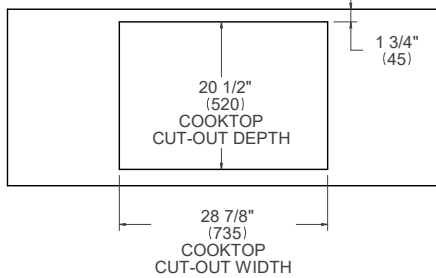

TOP VIEW – OVEN DETAIL

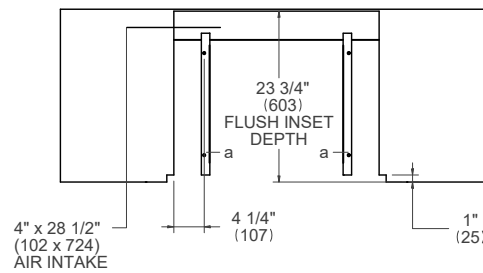

SIDE VIEW

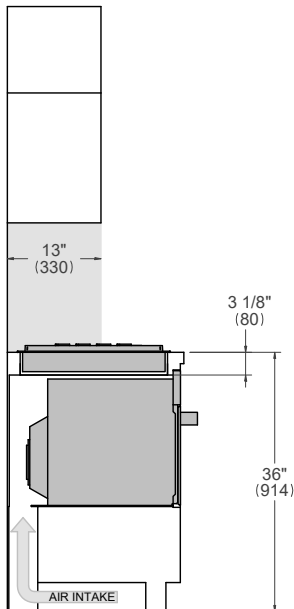

FRONT VIEW

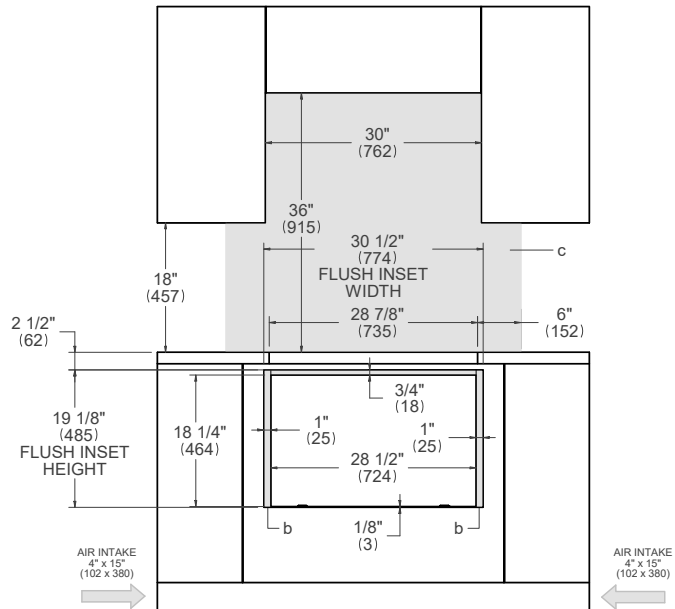

- (a) Spacers - Included with appliance
- (b) Visible Area - Match finish to outside cabinet panels
- (c) Combustible material cannot be installed within shaded area

For electrical and gas supply please see single installation requirements. Placement within the opening may require additional cabinet depth.

30" Specialty Oven + 36" Cooktop XV

Flush installation

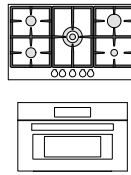

PROF30SOEX PROF365CTXV
 PROF30CSEX
 MAST30SOEX
 MAST30CSEX

TOP VIEW – COOKTOP DETAIL

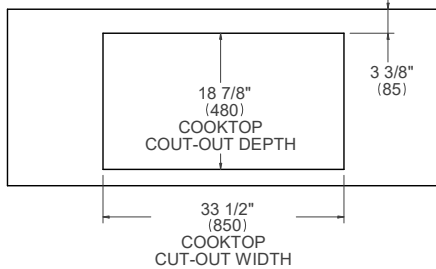

TOP VIEW – OVEN DETAIL

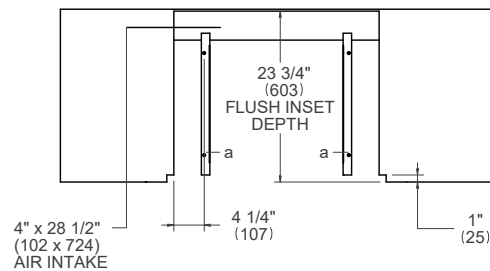

SIDE VIEW

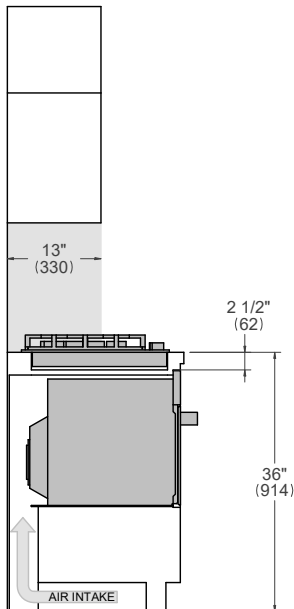

FRONT VIEW

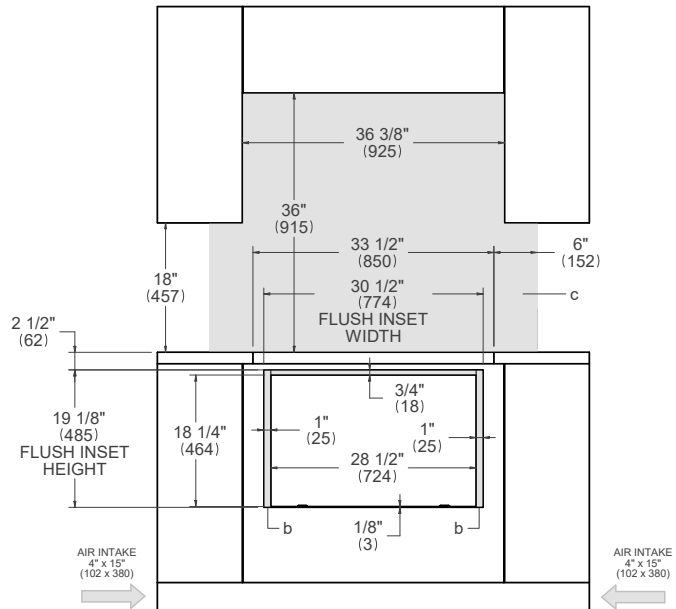

- (a) Spacers - Included with appliance
- (b) Visible Area - Match finish to outside cabinet panels
- (c) Combustible material cannot be installed within shaded area

For electrical and gas supply please see single installation requirements. Placement within the opening may require additional cabinet depth.

30" Specialty Oven + 30" Cooktop XV

Flush installation

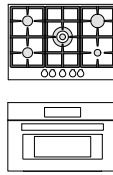

PROF30SOEX PROF305CTXV
 PROF30CSEX
 MAST30SOEX
 MAST30CSEX

TOP VIEW – COOKTOP DETAIL

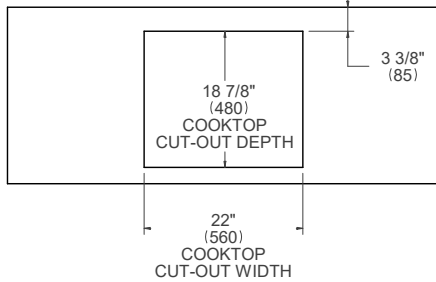

TOP VIEW – OVEN DETAIL

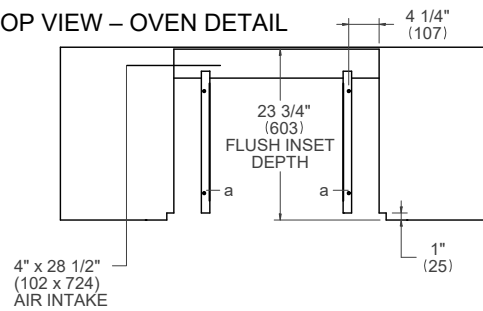

SIDE VIEW

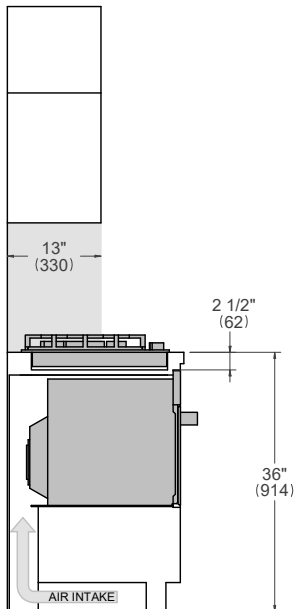

FRONT VIEW

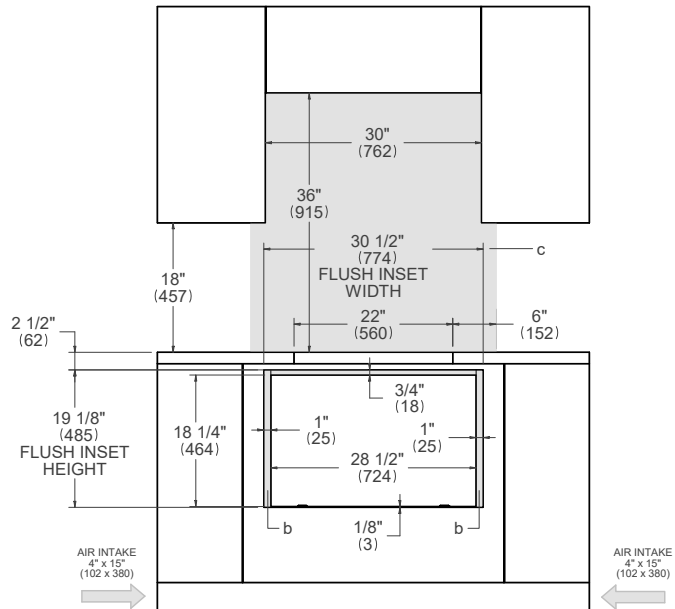

- (a) Spacers - Included with appliance
- (b) Visible Area - Match finish to outside cabinet panels
- (c) Combustible material cannot be installed within shaded area

For electrical and gas supply please see single installation requirements. Placement within the opening may require additional cabinet depth.

30" Specialty Oven + 36" Induction Cooktop

Flush installation

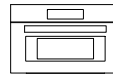
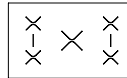

PROF30SOEX P365IAE
 PROF30CSEX
 MAST30SOEX
 MAST30CSEX

TOP VIEW – COOKTOP DETAIL

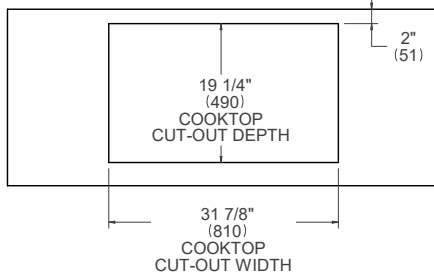

TOP VIEW – OVEN DETAIL

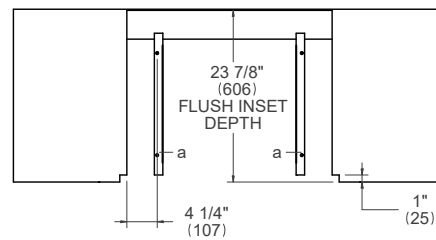

SIDE VIEW

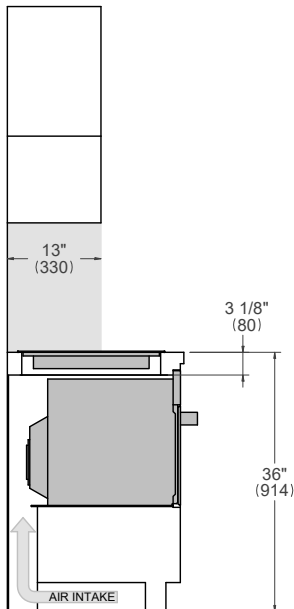

FRONT VIEW

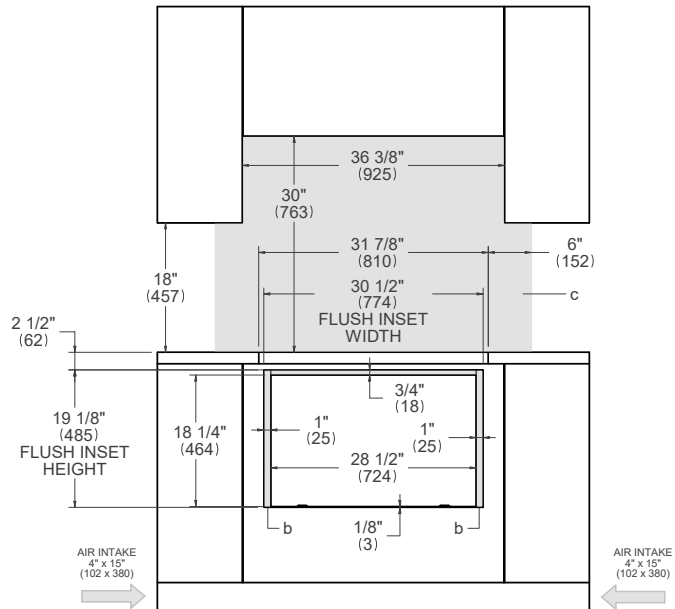

- (a) Spacers - Included with appliance
- (b) Visible Area - Match finish to outside cabinet panels
- (c) Combustible material cannot be installed within shaded area

For electrical and gas supply please see single installation requirements. Placement within the opening may require additional cabinet depth.

30" Specialty Oven + 30" Induction Cooktop

Flush installation

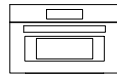
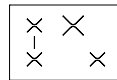

PROF30SOEX P304IAE
 PROF30CSEX
 MAST30SOEX
 MAST30CSEX

TOP VIEW – COOKTOP DETAIL

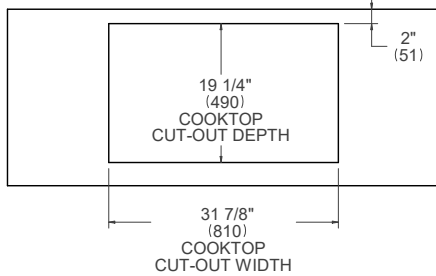

TOP VIEW – OVEN DETAIL

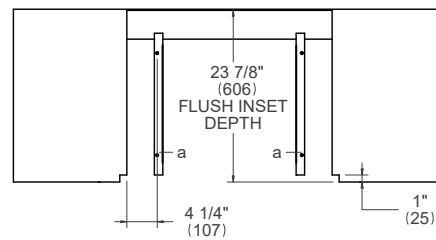

SIDE VIEW

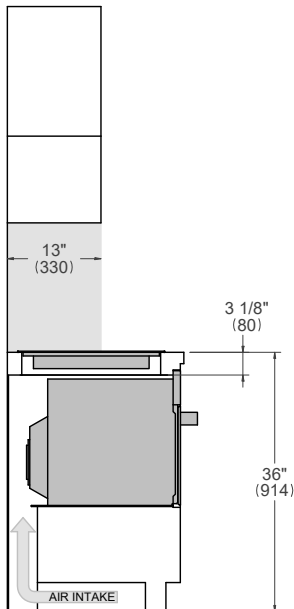

FRONT VIEW

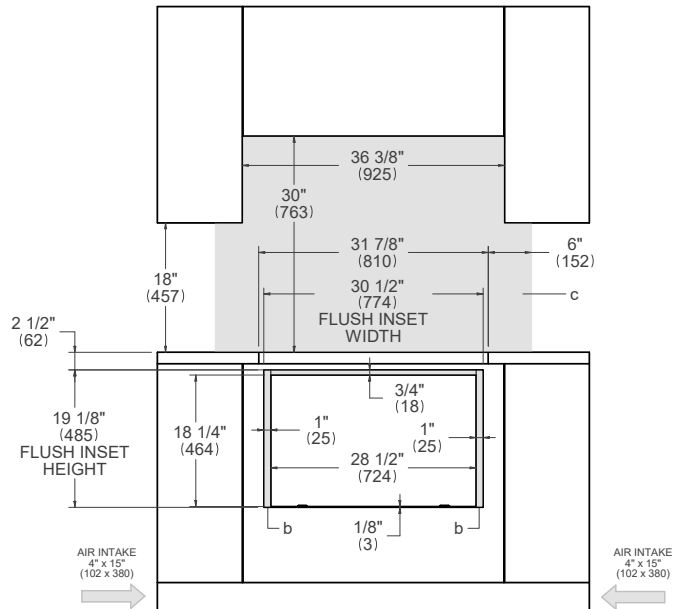

- (a) Spacers - Included with appliance
- (b) Visible Area - Match finish to outside cabinet panels
- (c) Combustible material cannot be installed within shaded area

For electrical and gas supply please see single installation requirements. Placement within the opening may require additional cabinet depth.

24" Convection Oven + 36" Drop-in Cooktop

Flush installation

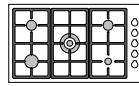

PROF24FSEXV PROF366QBXT MAST366QBXT
 PROF365QBXT MAST365QBXT
 PRO365QXE MAST365QXE

TOP VIEW – COOKTOP DETAIL

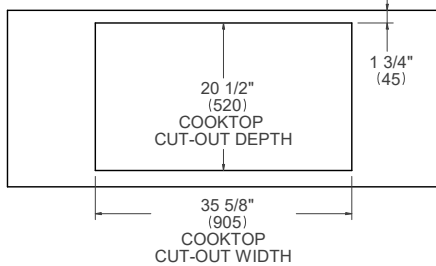

TOP VIEW – OVEN DETAIL

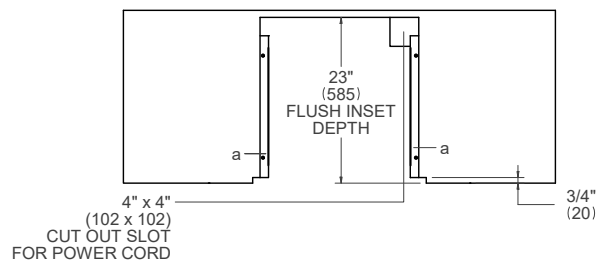

SIDE VIEW

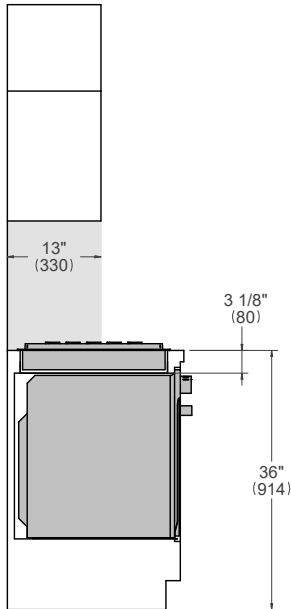

FRONT VIEW

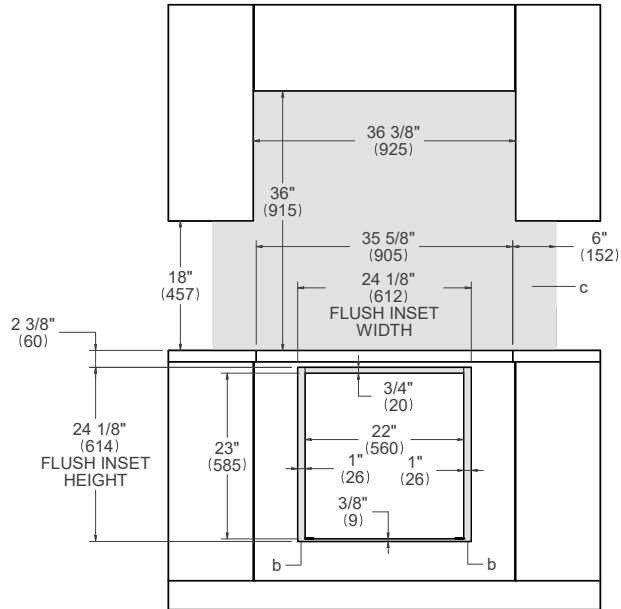

- (a) Spacers - Included with appliance
- (b) Visible Area - Match finish to outside cabinet panels
- (c) Combustible material cannot be installed within shaded area

For electrical and gas supply please see single installation requirements. Placement within the opening may require additional cabinet depth.

24" Convection Oven + 30" Drop-in Cooktop

Flush installation

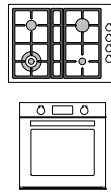

PROF24SOEX PROF304QBXT
 PROF304QXE
 MAST304QBXT
 MAST304QXE

TOP VIEW – COOKTOP DETAIL

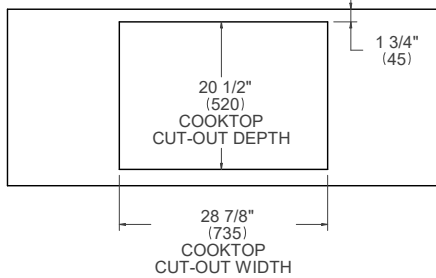

TOP VIEW – OVEN DETAIL

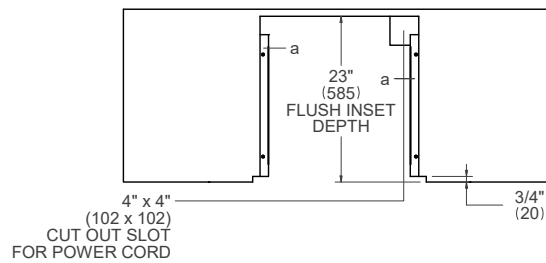

SIDE VIEW

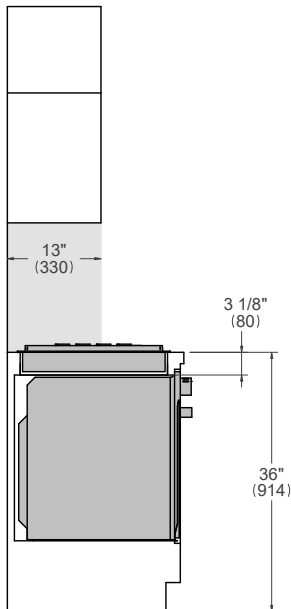

FRONT VIEW

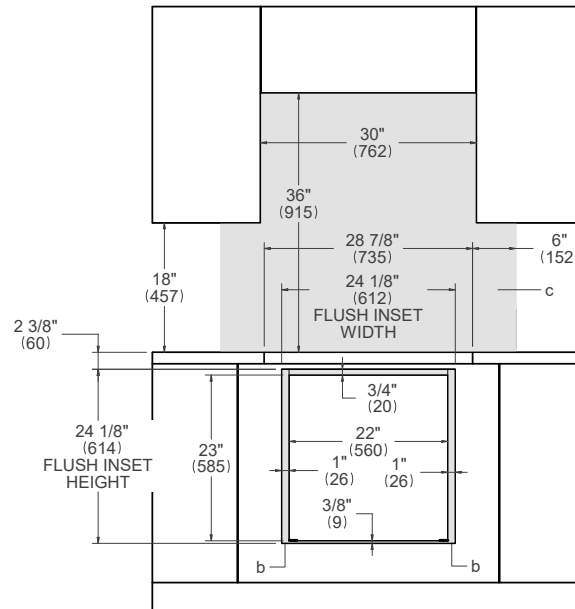

- (a) Spacers - Included with appliance
- (b) Visible Area - Match finish to outside cabinet panels
- (c) Combustible material cannot be installed within shaded area

For electrical and gas supply please see single installation requirements. Placement within the opening may require additional cabinet depth.

24" Convection Oven + 36" Cooktop XV

Flush installation

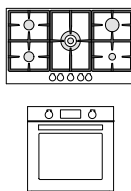

PROF24FSEXV PROF365CTXV

TOP VIEW – COOKTOP DETAIL

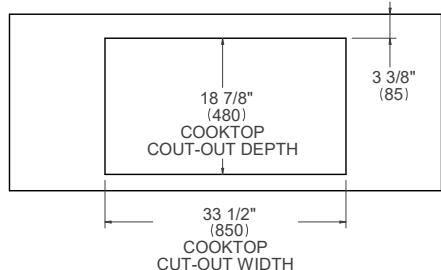

TOP VIEW – OVEN DETAIL

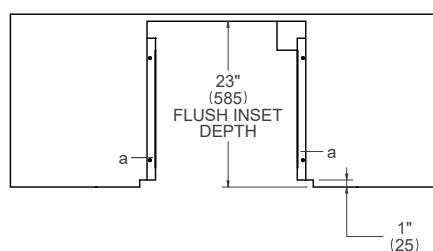

SIDE VIEW

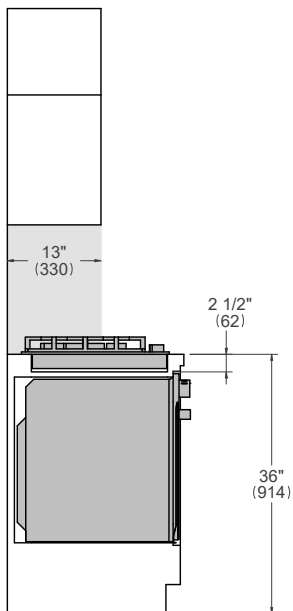

FRONT VIEW

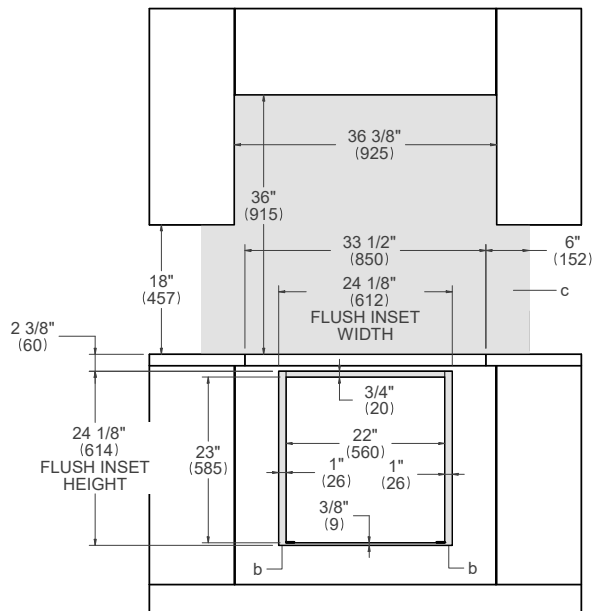

- (a) Spacers - Included with appliance
- (b) Visible Area - Match finish to outside cabinet panels
- (c) Combustible material cannot be installed within shaded area

For electrical and gas supply please see single installation requirements. Placement within the opening may require additional cabinet depth.

24" Convection Oven + 30" Cooktop XV

Flush installation

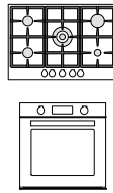

PROF24FSEXV PROF305CTXV

TOP VIEW – COOKTOP DETAIL

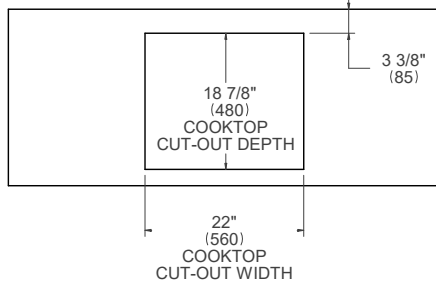

TOP VIEW – OVEN DETAIL

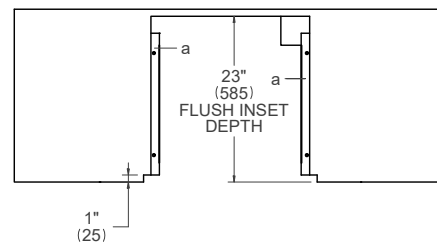

SIDE VIEW

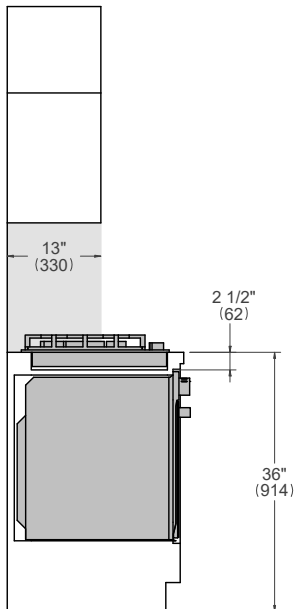

FRONT VIEW

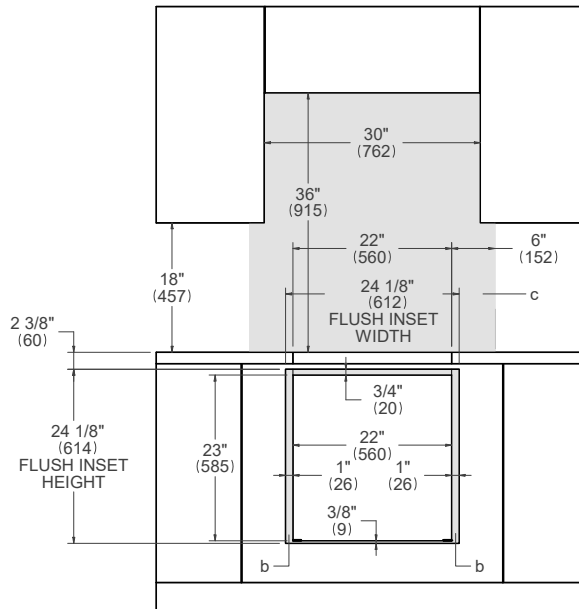

- (a) Spacers - Included with appliance
- (b) Visible Area - Match finish to outside cabinet panels
- (c) Combustible material cannot be installed within shaded area

For electrical and gas supply please see single installation requirements. Placement within the opening may require additional cabinet depth.

24" Convection Oven + 24" Cooktop XV

Flush installation



PROF24FSEXV PROF244CTXV

TOP VIEW – COOKTOP DETAIL

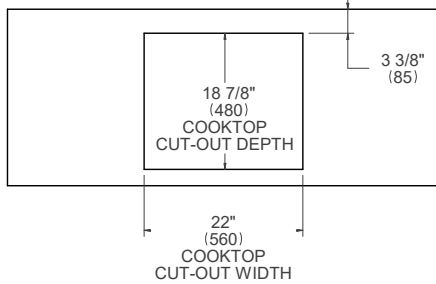

TOP VIEW – OVEN DETAIL

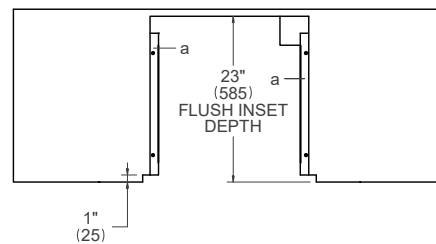

SIDE VIEW

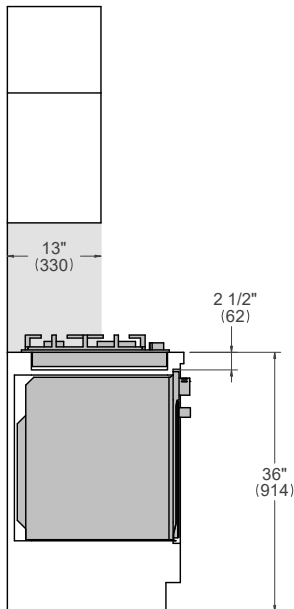

FRONT VIEW

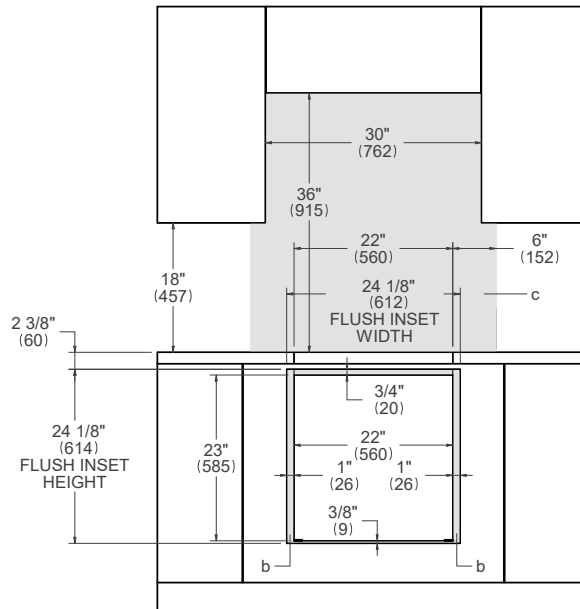

- (a) Spacers - Included with appliance
- (b) Visible Area - Match finish to outside cabinet panels
- (c) Combustible material cannot be installed within shaded area

For electrical and gas supply please see single installation requirements. Placement within the opening may require additional cabinet depth.

24" Convection Oven + 36" Induction Cooktop

Flush installation

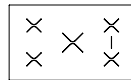

PROF24FSEXV P365IAE

TOP VIEW – COOKTOP DETAIL

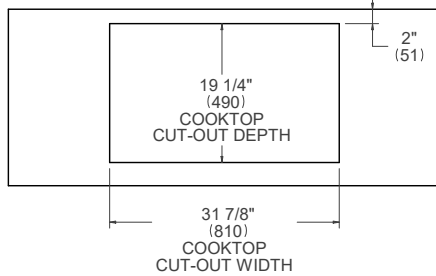

TOP VIEW – OVEN DETAIL

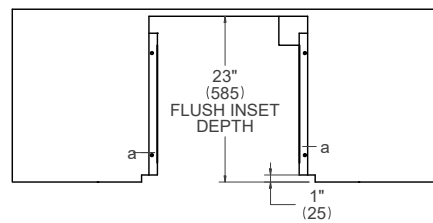

SIDE VIEW

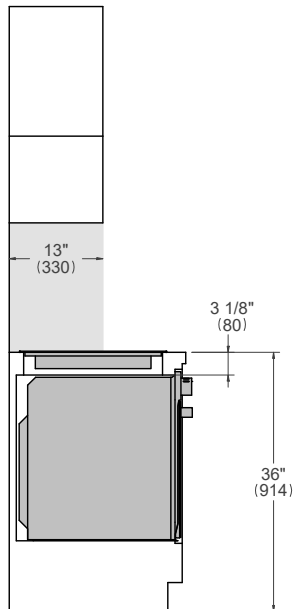

FRONT VIEW

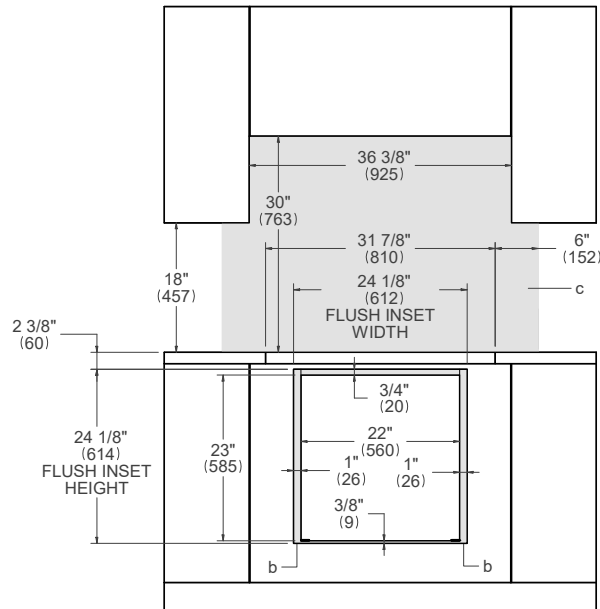

- (a) Spacers - Included with appliance
- (b) Visible Area - Match finish to outside cabinet panels
- (c) Combustible material cannot be installed within shaded area

For electrical and gas supply please see single installation requirements. Placement within the opening may require additional cabinet depth.

24" Convection Oven + 30" Induction Cooktop

Flush installation

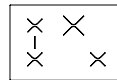

PROF24FSEXV P304IAE

TOP VIEW – COOKTOP DETAIL

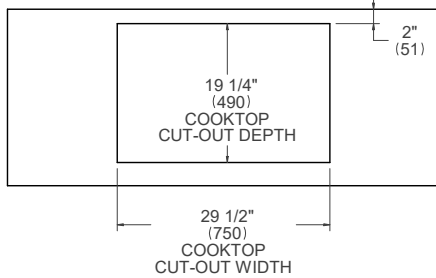

TOP VIEW – OVEN DETAIL

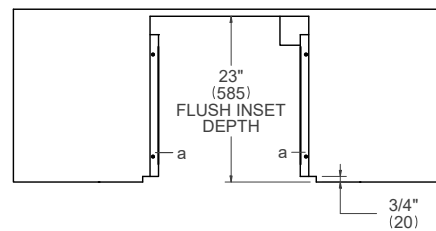

SIDE VIEW

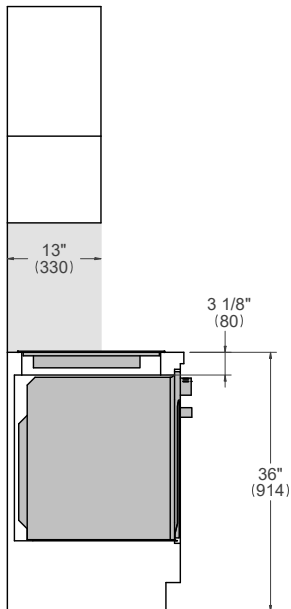

FRONT VIEW

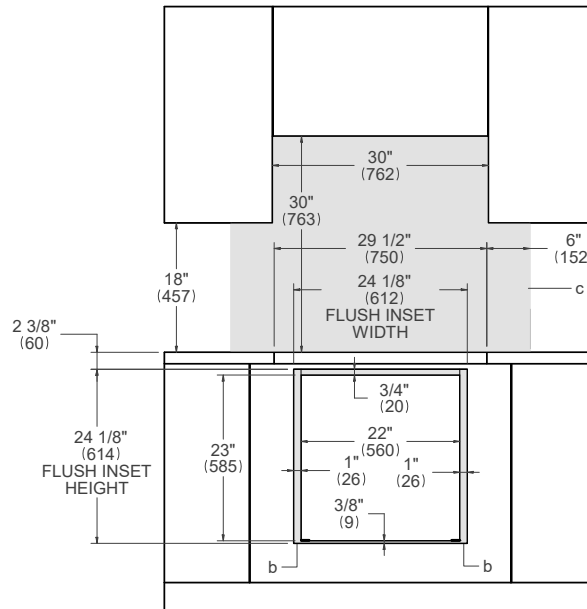

- (a) Spacers - Included with appliance
- (b) Visible Area - Match finish to outside cabinet panels
- (c) Combustible material cannot be installed within shaded area

For electrical and gas supply please see single installation requirements. Placement within the opening may require additional cabinet depth.

24" Convection Oven + 30" Electric Ceramic Cooktop

Flush installation

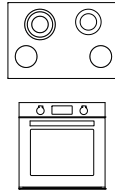

PE304CER

PROF24FSEXV

TOP VIEW – COOKTOP DETAIL

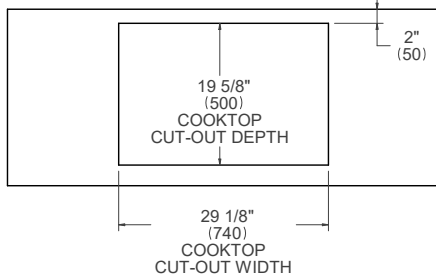

TOP VIEW – OVEN DETAIL

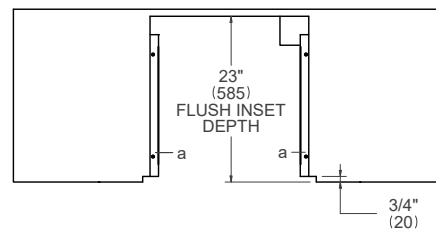

SIDE VIEW

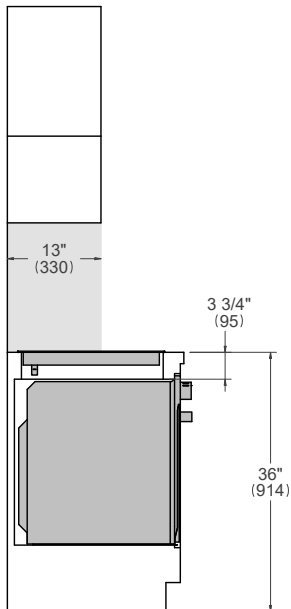

FRONT VIEW

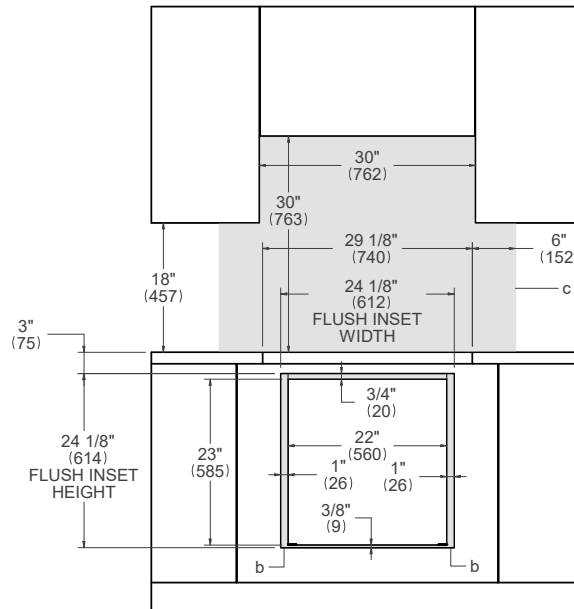

- (a) Spacers - Included with appliance
- (b) Visible Area - Match finish to outside cabinet panels
- (c) Combustible material cannot be installed within shaded area

For electrical and gas supply please see single installation requirements. Placement within the opening may require additional cabinet depth.

24" Convection Oven + 24" Electric Ceramic Cooktop

Flush installation

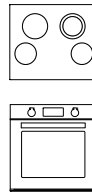

PE244CER

PROF24FSEXV

TOP VIEW – COOKTOP DETAIL

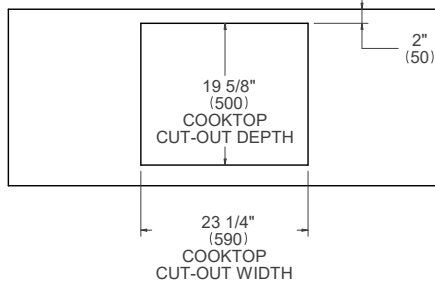

TOP VIEW – OVEN DETAIL

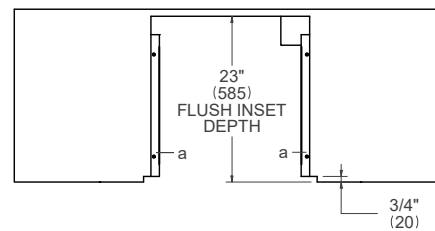

SIDE VIEW

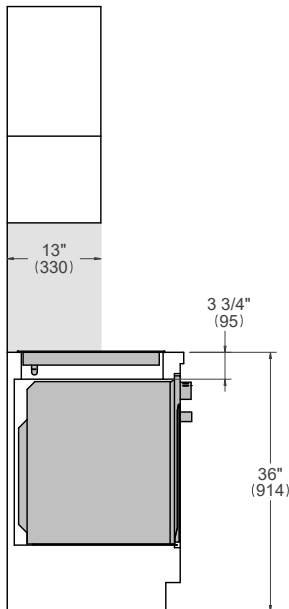

FRONT VIEW

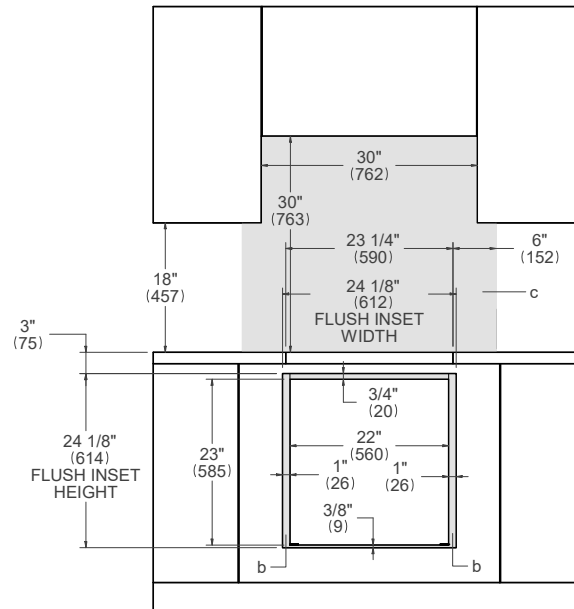

- (a) Spacers - Included with appliance
- (b) Visible Area - Match finish to outside cabinet panels
- (c) Combustible material cannot be installed within shaded area

For electrical and gas supply please see single installation requirements. Placement within the opening may require additional cabinet depth.

24" Specialty Oven + 36" Drop-in Cooktop

Flush installation

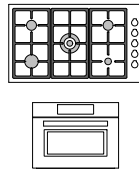

PROF24SOEXV MAST366QBXT
 PROF366QBXT MAST365QBXT
 PROF365QBXT MAST365QXE
 PROF365QXE

TOP VIEW – COOKTOP DETAIL

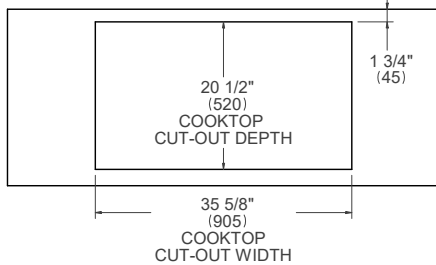

TOP VIEW – OVEN DETAIL

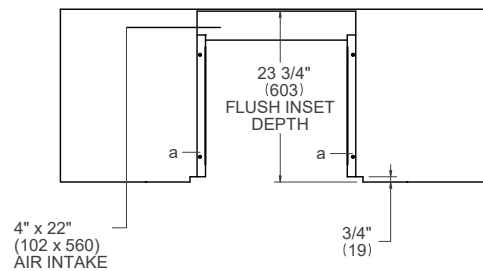

SIDE VIEW

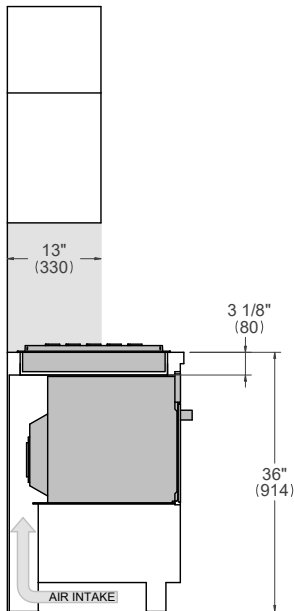

FRONT VIEW

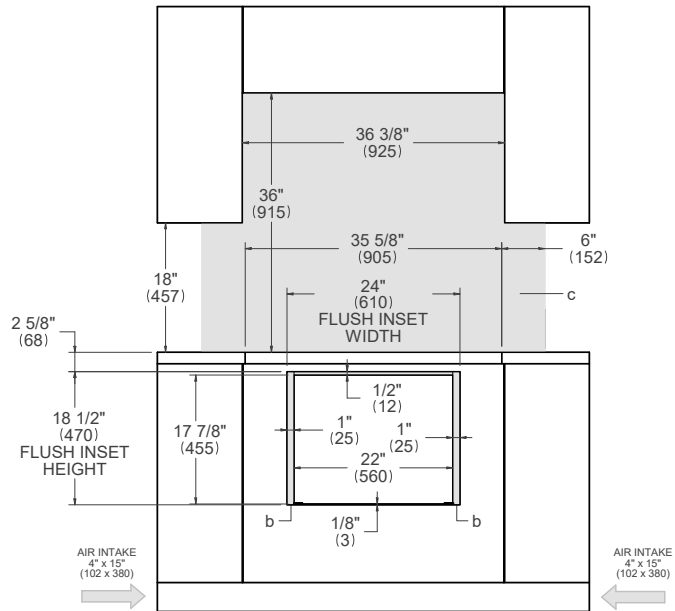

- (a) Spacers - Included with appliance
- (b) Visible Area - Match finish to outside cabinet panels
- (c) Combustible material cannot be installed within shaded area

For electrical and gas supply please see single installation requirements. Placement within the opening may require additional cabinet depth.

24" Specialty Oven + 30" Drop-in Cooktop

Flush installation

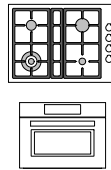

PROF24SOEX PROF304QBXT
 PROF304QXE
 MAST304QBXT
 MAST304QXE

TOP VIEW – COOKTOP DETAIL

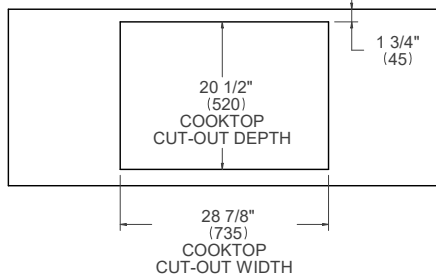

TOP VIEW – OVEN DETAIL

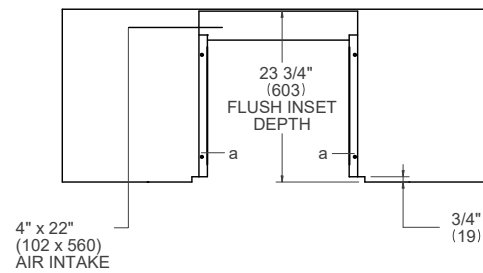

SIDE VIEW

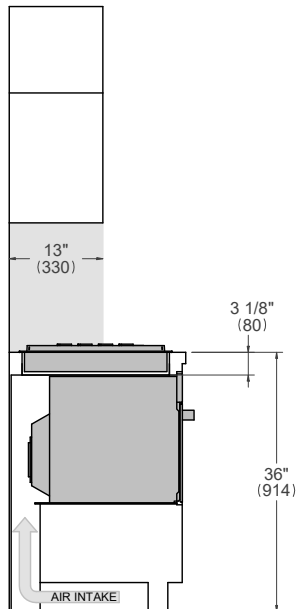

FRONT VIEW

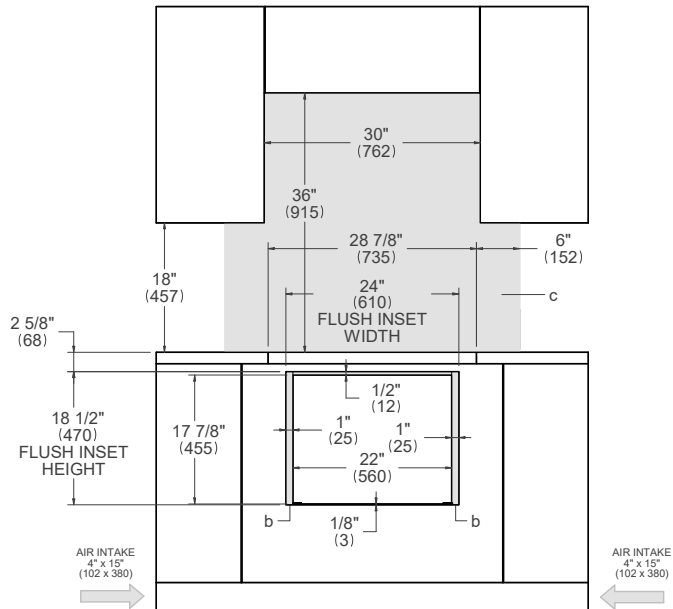

- (a) Spacers - Included with appliance
- (b) Visible Area - Match finish to outside cabinet panels
- (c) Combustible material cannot be installed within shaded area

For electrical and gas supply please see single installation requirements. Placement within the opening may require additional cabinet depth.

24" Specialty Oven + 36" Cooktop XV

Flush installation

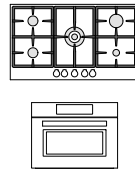

PROF24SOEX PROF365CTXV

TOP VIEW – COOKTOP DETAIL

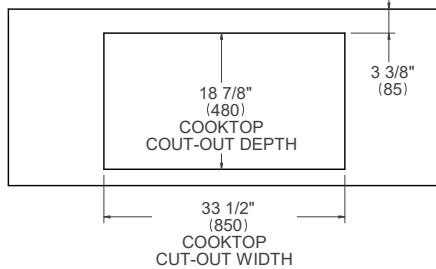

TOP VIEW – OVEN DETAIL

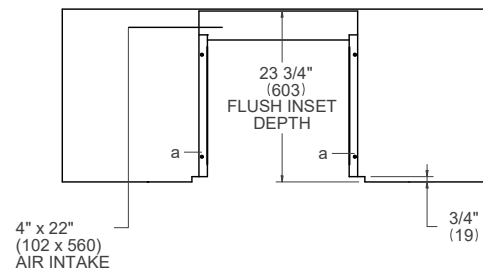

SIDE VIEW

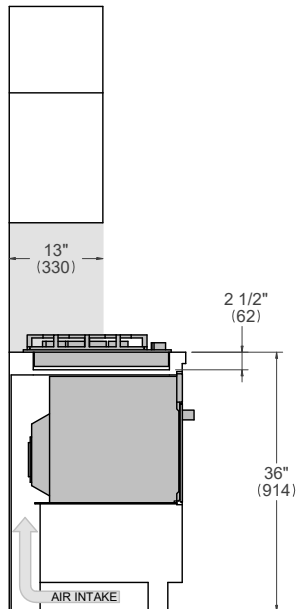

FRONT VIEW

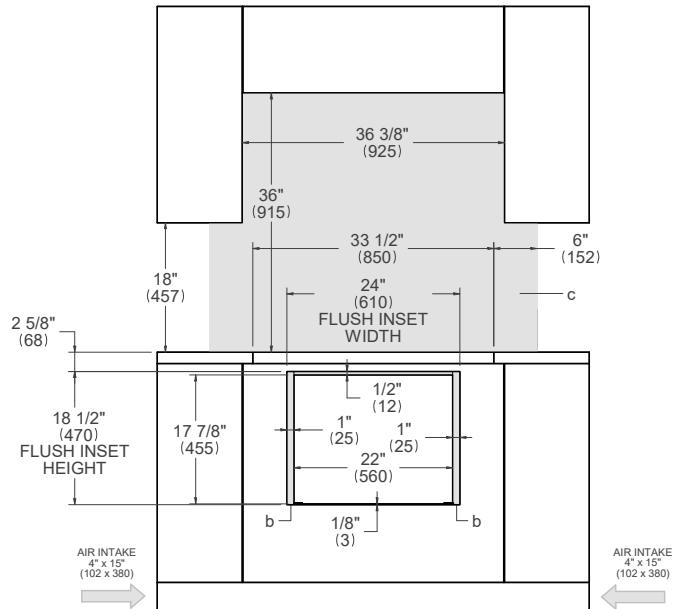

- (a) Spacers - Included with appliance
- (b) Visible Area - Match finish to outside cabinet panels
- (c) Combustible material cannot be installed within shaded area

For electrical and gas supply please see single installation requirements. Placement within the opening may require additional cabinet depth.

24" Specialty Oven + 30" Cooktop XV

Flush installation

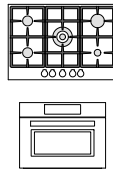

PROF24SOEX PROF305CTXV

TOP VIEW – COOKTOP DETAIL

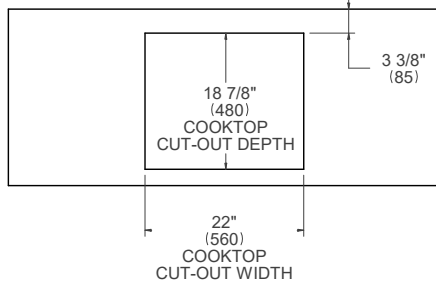

TOP VIEW – OVEN DETAIL

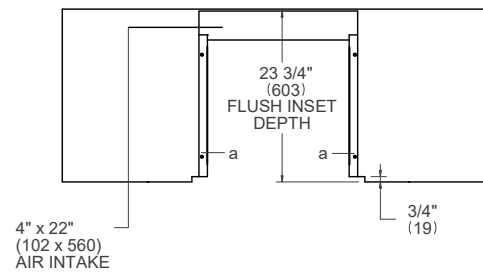

SIDE VIEW

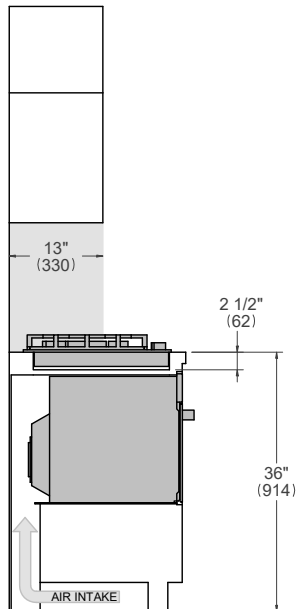

FRONT VIEW

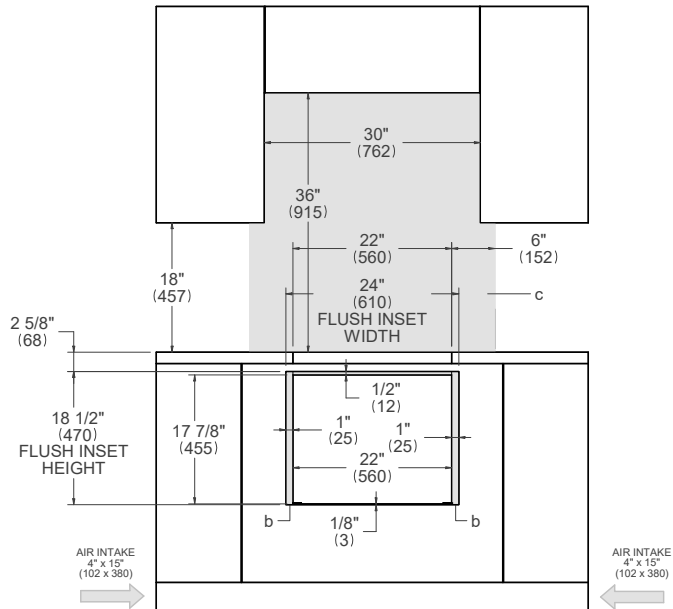

- (a) Spacers - Included with appliance
- (b) Visible Area - Match finish to outside cabinet panels
- (c) Combustible material cannot be installed within shaded area

For electrical and gas supply please see single installation requirements. Placement within the opening may require additional cabinet depth.

24" Specialty Oven + 24" Cooktop XV

Flush installation

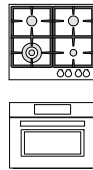

PROF24SOEX PROF244CTXV

TOP VIEW – COOKTOP DETAIL

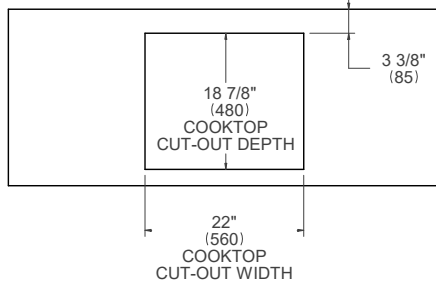

TOP VIEW – OVEN DETAIL

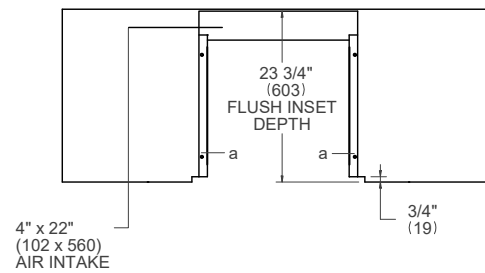

SIDE VIEW

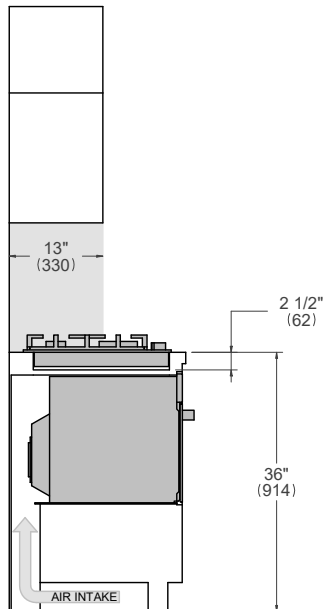

FRONT VIEW

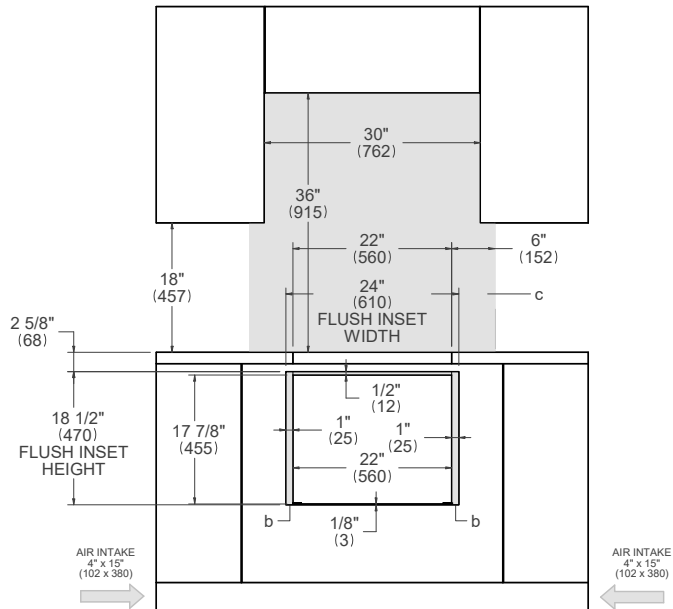

- (a) Spacers - Included with appliance
- (b) Visible Area - Match finish to outside cabinet panels
- (c) Combustible material cannot be installed within shaded area

For electrical and gas supply please see single installation requirements. Placement within the opening may require additional cabinet depth.

24" Specialty Oven + 36" Induction Cooktop

Flush installation

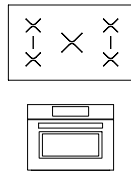

PROF24SOEX P365IAE

TOP VIEW – COOKTOP DETAIL

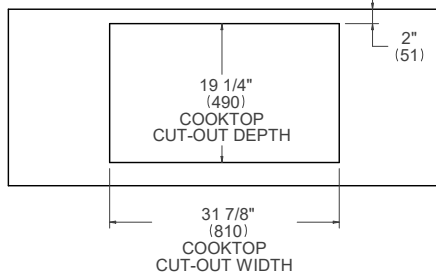

TOP VIEW – OVEN DETAIL

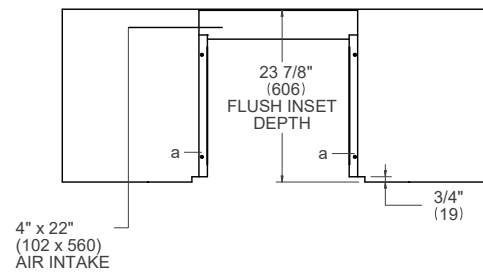

SIDE VIEW

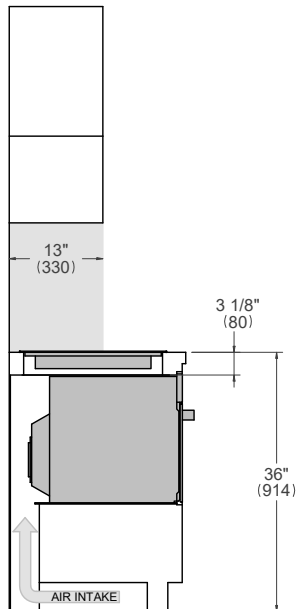

FRONT VIEW

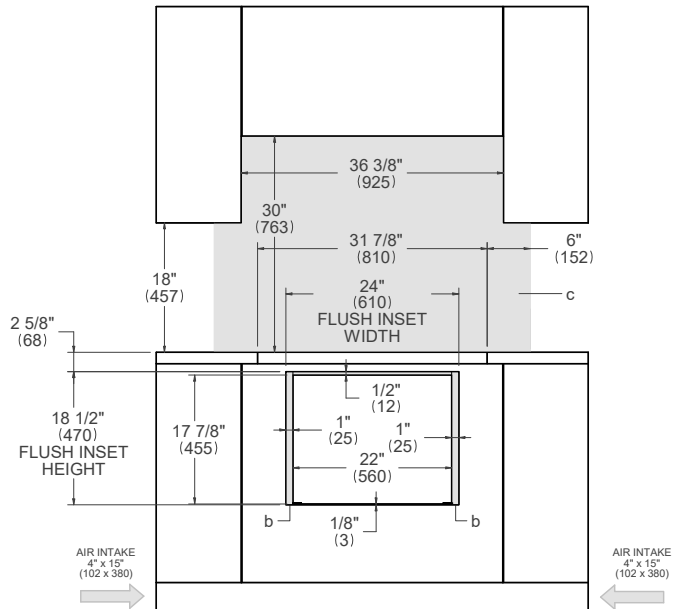

- (a) Spacers - Included with appliance
- (b) Visible Area - Match finish to outside cabinet panels
- (c) Combustible material cannot be installed within shaded area

For electrical and gas supply please see single installation requirements. Placement within the opening may require additional cabinet depth.

24" Specialty Oven + 30" Induction Cooktop

Flush installation

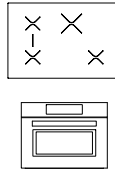

PROF24SOEX P304IAE

TOP VIEW – COOKTOP DETAIL

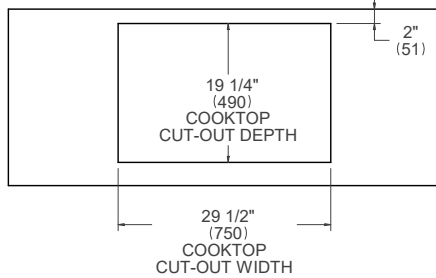

TOP VIEW – OVEN DETAIL

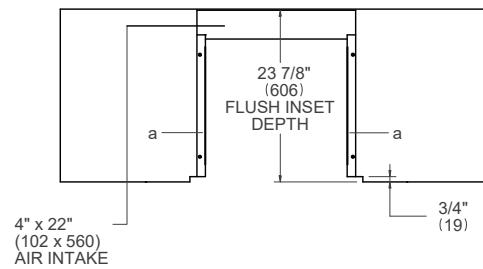

SIDE VIEW

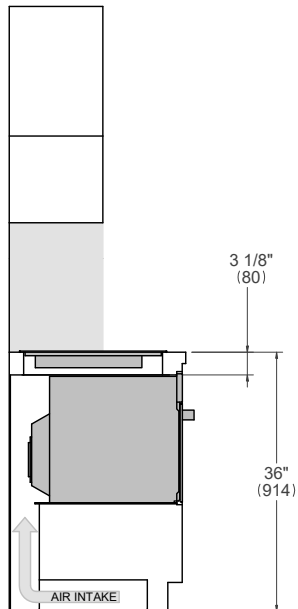

FRONT VIEW

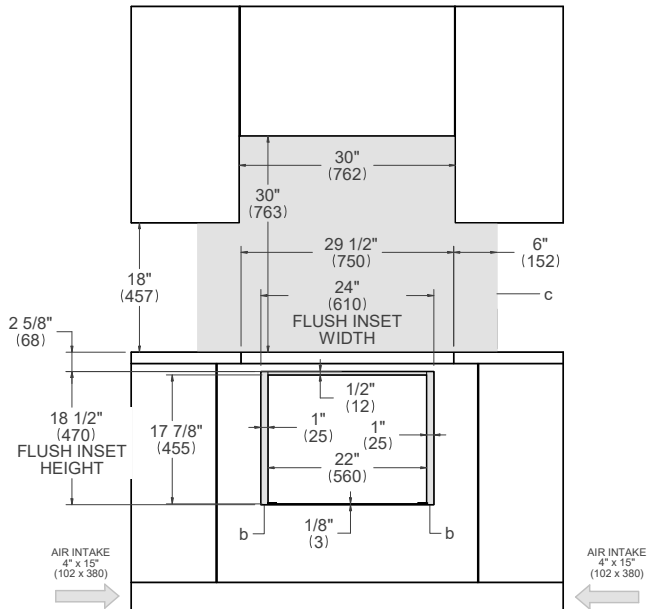

- (a) Spacers - Included with appliance
- (b) Visible Area - Match finish to outside cabinet panels
- (c) Combustible material cannot be installed within shaded area

For electrical and gas supply please see single installation requirements. Placement within the opening may require additional cabinet depth.

24" Specialty Oven + 30" Electric Ceramic Cooktop

Flush installation

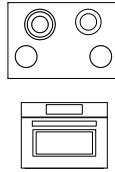

P304CER

PROF24SOEX

TOP VIEW – COOKTOP DETAIL

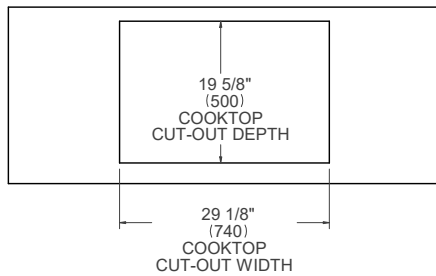

TOP VIEW – OVEN DETAIL

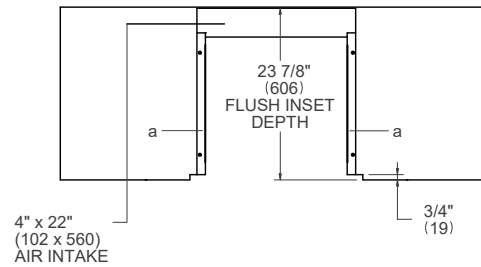

SIDE VIEW

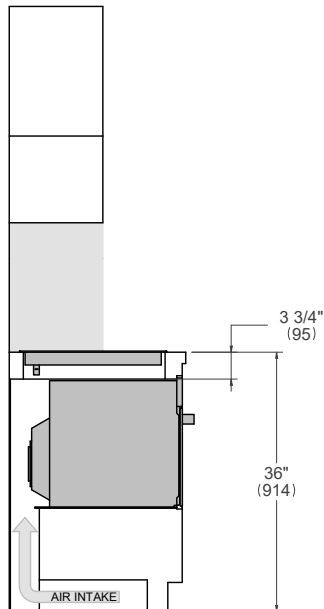

FRONT VIEW

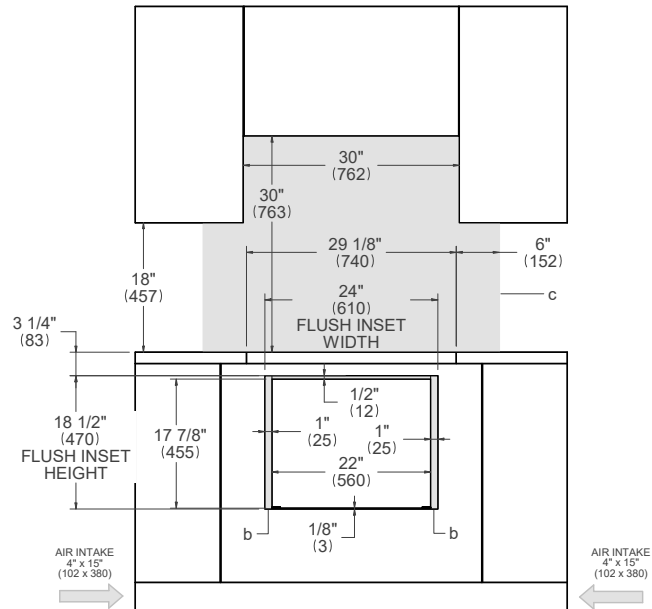

- (a) Spacers - Included with appliance
- (b) Visible Area - Match finish to outside cabinet panels
- (c) Combustible material cannot be installed within shaded area

For electrical and gas supply please see single installation requirements. Placement within the opening may require additional cabinet depth.

24" Specialty Oven + 24" Electric Ceramic Cooktop

Flush installation

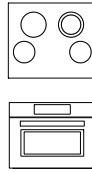

PE244CER

PROF24SOEX

TOP VIEW – COOKTOP DETAIL

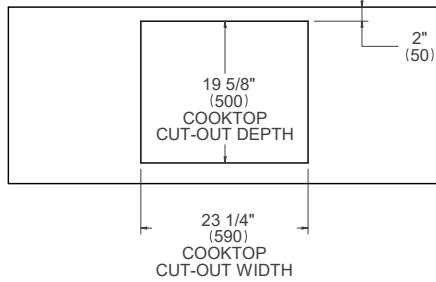

TOP VIEW – OVEN DETAIL

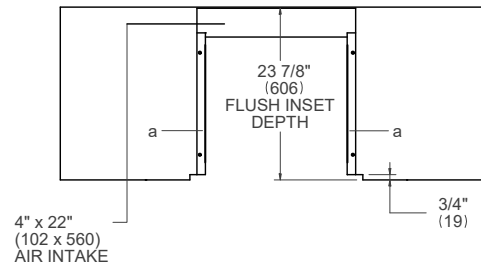

SIDE VIEW

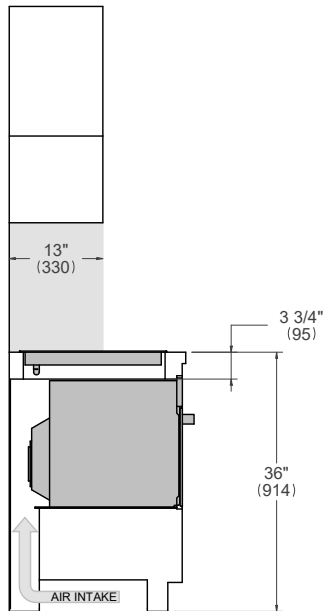

FRONT VIEW

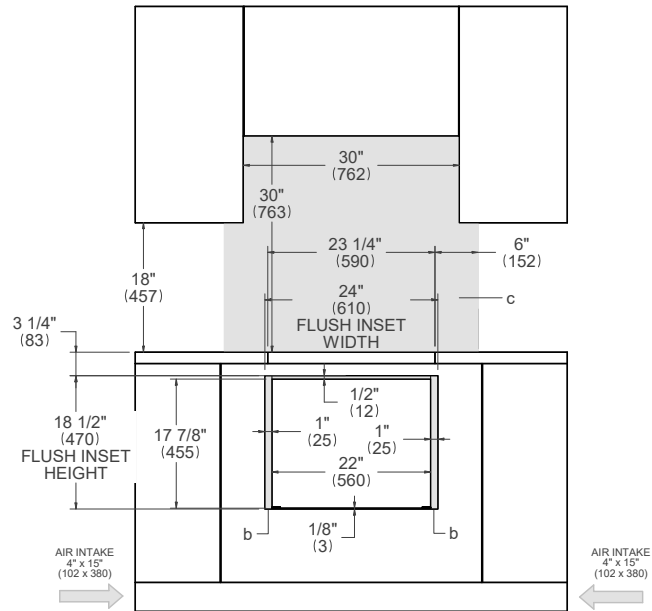

- (a) Spacers - Included with appliance
- (b) Visible Area - Match finish to outside cabinet panels
- (c) Combustible material cannot be installed within shaded area

For electrical and gas supply please see single installation requirements. Placement within the opening may require additional cabinet depth.

24" Microwave Drawer + 36" Drop-in Cooktop

Flush installation

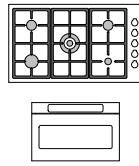

PROF366QBXT MAST366QBXT MD24X
 PROF365QBXT MAST365QBXT
 PROF365QXE MAST365QXE

TOP VIEW – COOKTOP DETAIL

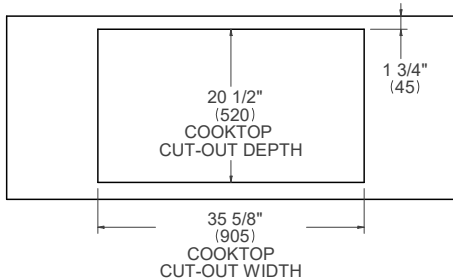

TOP VIEW – OVEN DETAIL

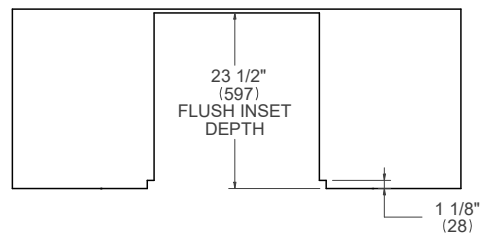

SIDE VIEW

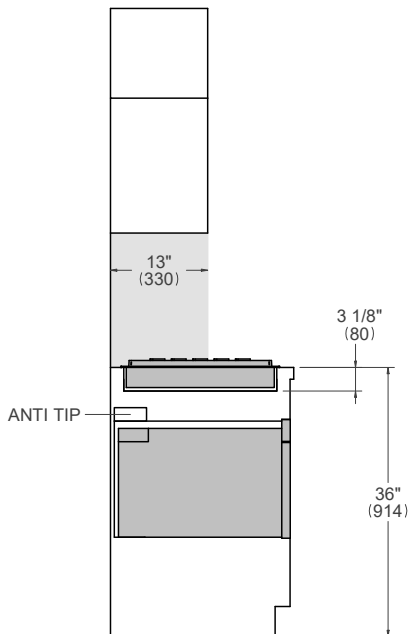

FRONT VIEW

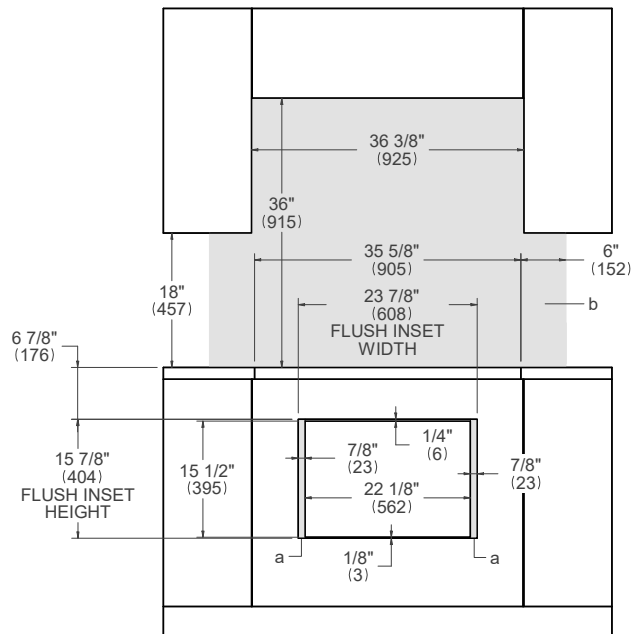

- (a) Visible Area - Match finish to outside cabinet panels
- (b) Combustible material cannot be installed within shaded area

For electrical and gas supply please see single installation requirements. Placement within the opening may require additional cabinet depth.

24" Microwave Drawer + 30" Drop-in Cooktop

Flush installation

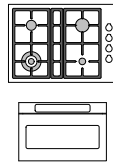

PROF304QBXT MAST304QBXT MD24X
PROF304QXE MAST304QXE

TOP VIEW – COOKTOP DETAIL

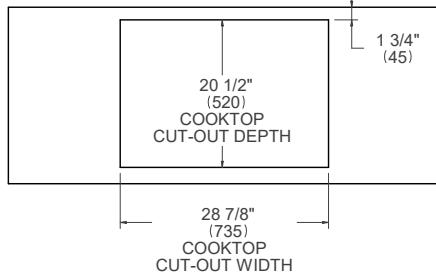

TOP VIEW – OVEN DETAIL

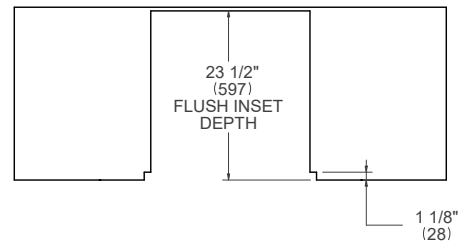

SIDE VIEW

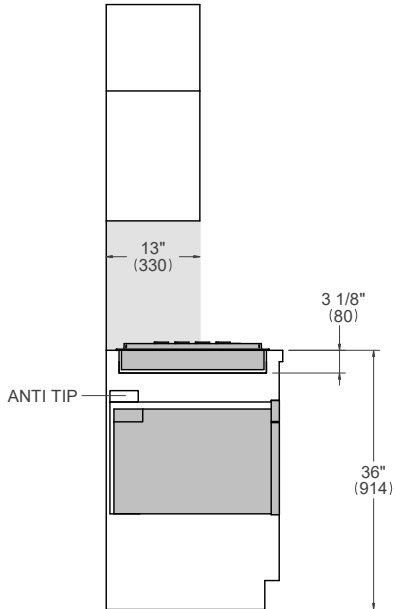

FRONT VIEW

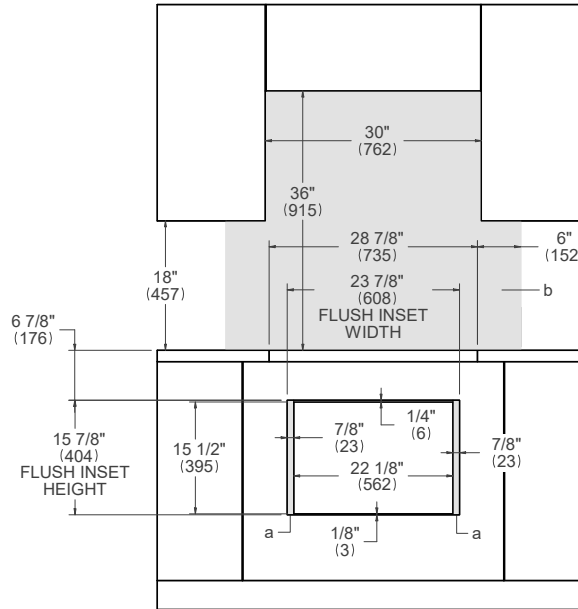

- (a) Visible Area - Match finish to outside cabinet panels
- (b) Combustible material cannot be installed within shaded area

For electrical and gas supply please see single installation requirements. Placement within the opening may require additional cabinet depth.

24" Microwave Drawer + 36" Cooktop XV Flush installation

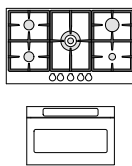

PROF365CTXV MD24X

TOP VIEW – COOKTOP DETAIL

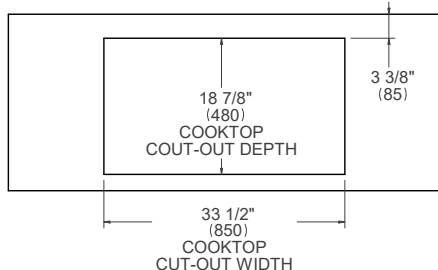

TOP VIEW – OVEN DETAIL

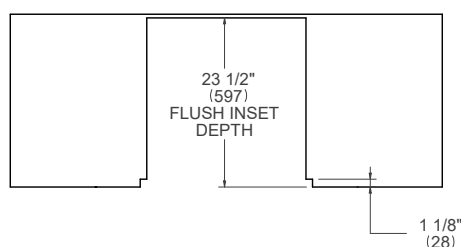

SIDE VIEW

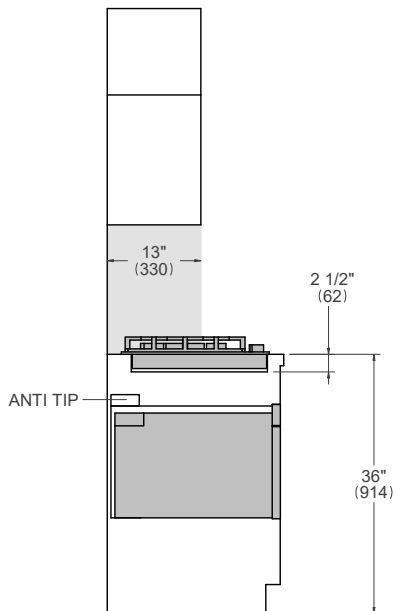

FRONT VIEW

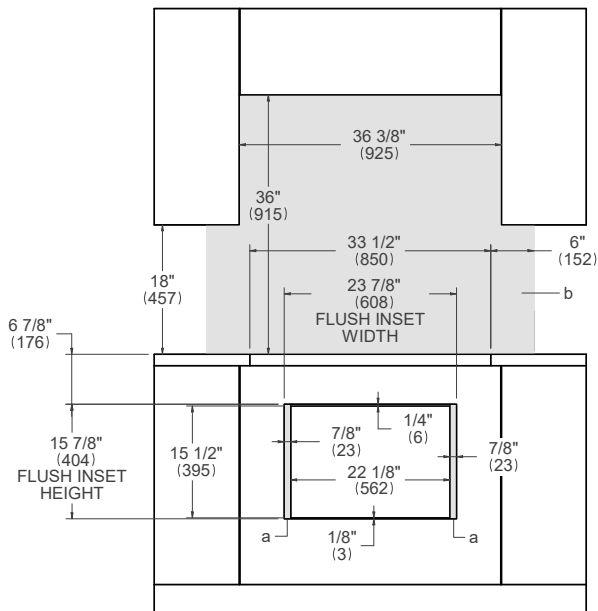

- (a) Visible Area - Match finish to outside cabinet panels
- (b) Combustible material cannot be installed within shaded area

For electrical and gas supply please see single installation requirements. Placement within the opening may require additional cabinet depth.

24" Microwave Drawer + 30" Cooktop XV

Flush installation

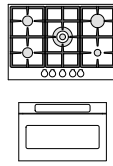

PROF305CTXV MD24X

TOP VIEW – COOKTOP DETAIL

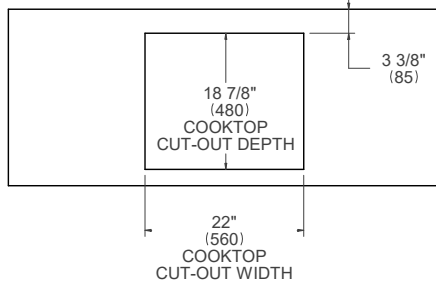

TOP VIEW – OVEN DETAIL

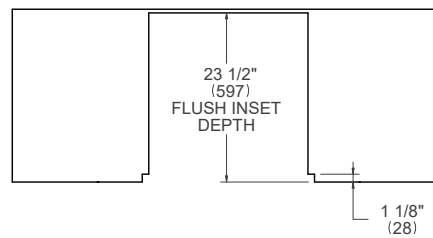

SIDE VIEW

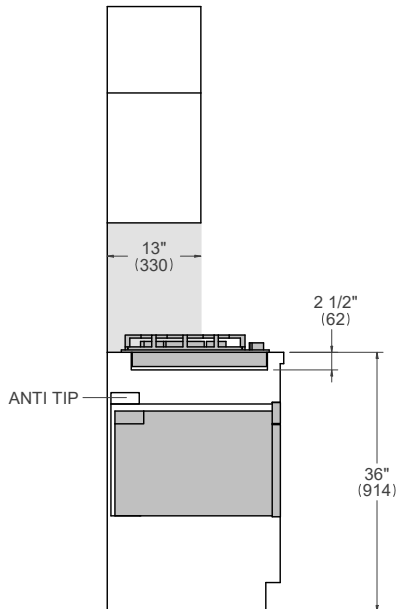

FRONT VIEW

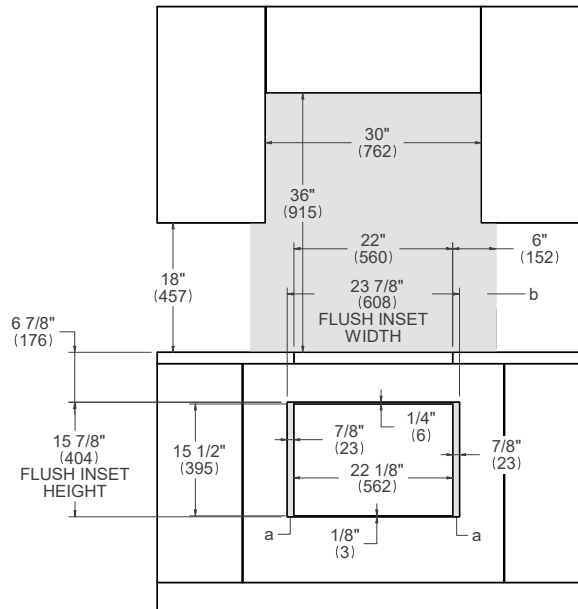

- (a) Visible Area - Match finish to outside cabinet panels
- (b) Combustible material cannot be installed within shaded area

For electrical and gas supply please see single installation requirements. Placement within the opening may require additional cabinet depth.

24" Microwave Drawer + 24" Cooktop XV

Flush installation

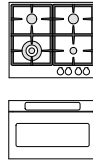

PROF244CTXV MD24X

TOP VIEW – COOKTOP DETAIL

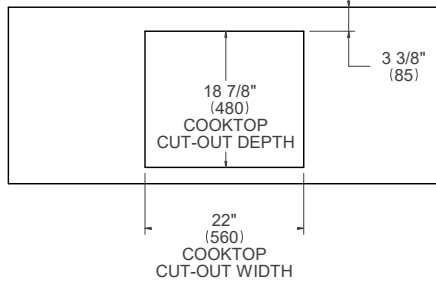

TOP VIEW – OVEN DETAIL

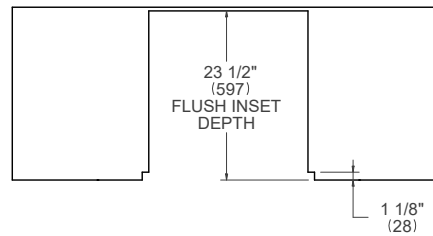

SIDE VIEW

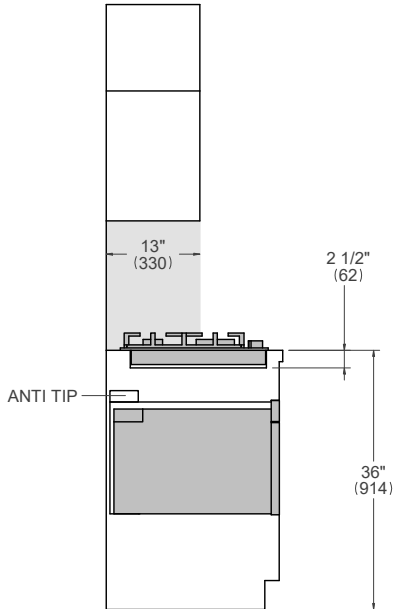

FRONT VIEW

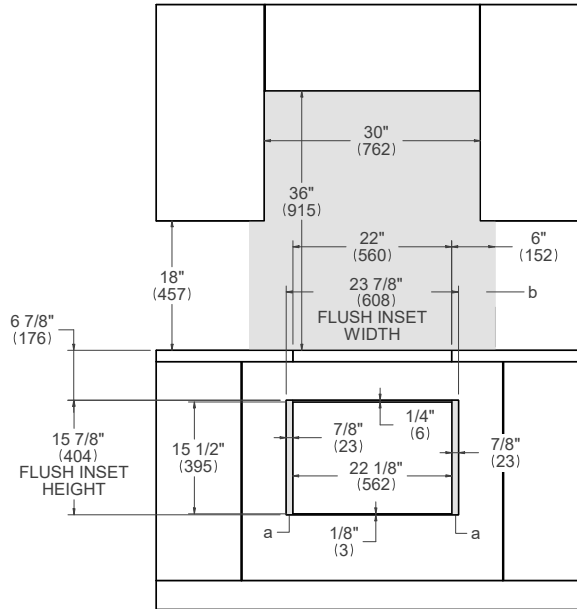

- (a) Visible Area - Match finish to outside cabinet panels
- (b) Combustible material cannot be installed within shaded area

For electrical and gas supply please see single installation requirements. Placement within the opening may require additional cabinet depth.

24" Microwave Drawer + 36" Induction Cooktop

Flush installation

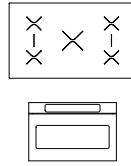

P365IAE

MD24X

TOP VIEW – COOKTOP DETAIL

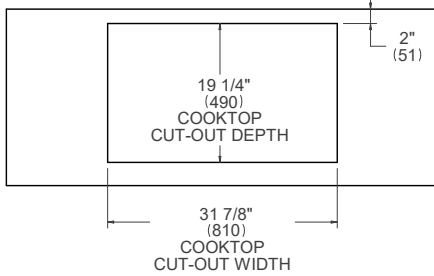

TOP VIEW – OVEN DETAIL

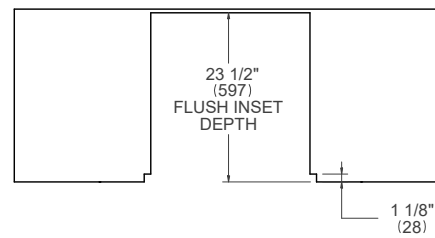

SIDE VIEW

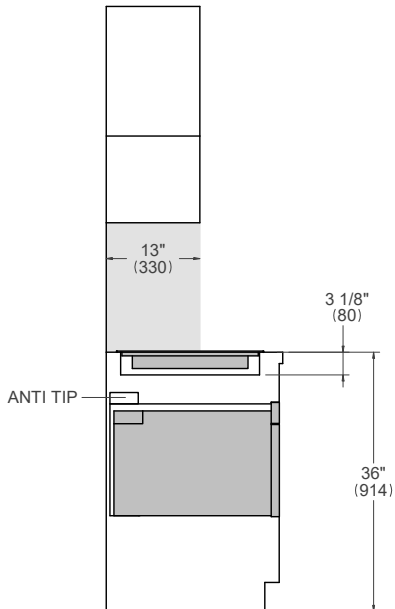

FRONT VIEW

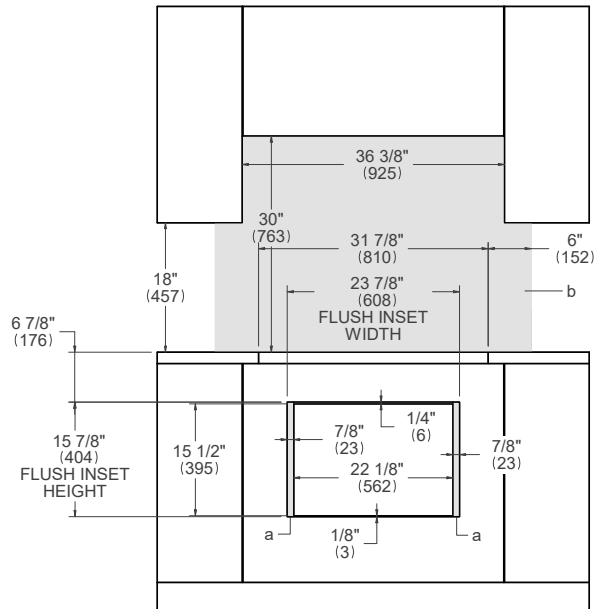

- (a) Visible Area - Match finish to outside cabinet panels
- (b) Combustible material cannot be installed within shaded area

For electrical and gas supply please see single installation requirements. Placement within the opening may require additional cabinet depth.

24" Microwave Drawer + 30" Induction Cooktop

Flush installation

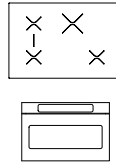

PE304IAE

MD24X

TOP VIEW – COOKTOP DETAIL

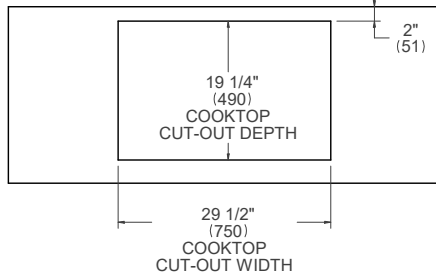

TOP VIEW – OVEN DETAIL

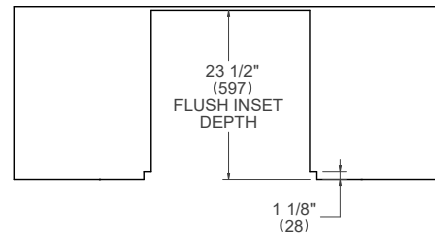

SIDE VIEW

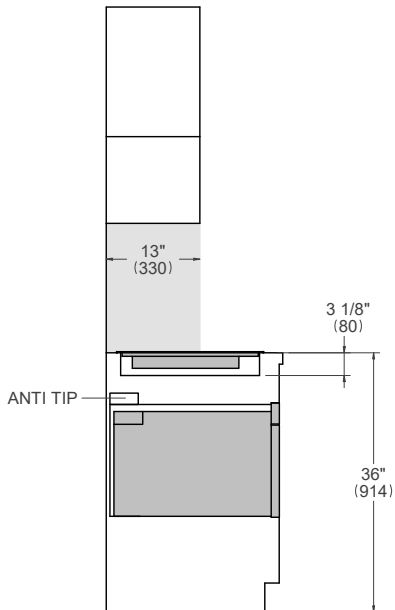

FRONT VIEW

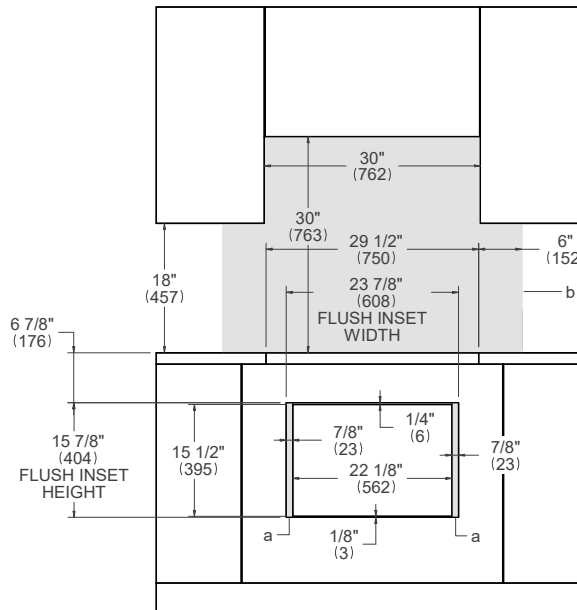

- (a) Visible Area - Match finish to outside cabinet panels
- (b) Combustible material cannot be installed within shaded area

For electrical and gas supply please see single installation requirements. Placement within the opening may require additional cabinet depth.

24" Microwave Drawer + 30" Electric Ceramic Cooktop

Flush installation

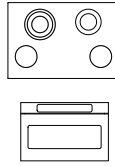

PE304CER

MD24X

TOP VIEW – COOKTOP DETAIL

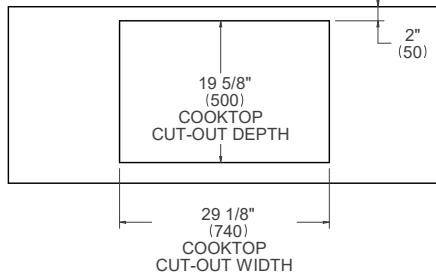

TOP VIEW – OVEN DETAIL

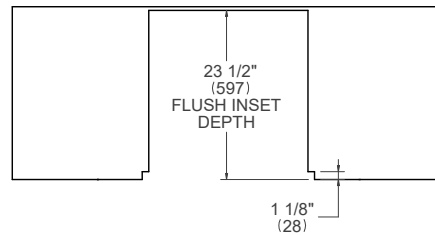

SIDE VIEW

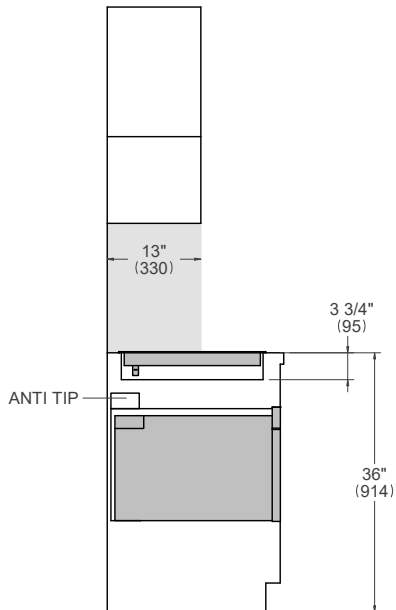

FRONT VIEW

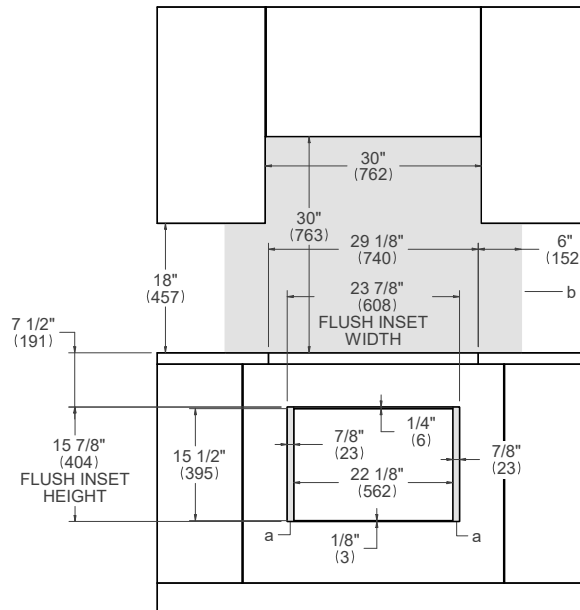

- (a) Visible Area - Match finish to outside cabinet panels
- (b) Combustible material cannot be installed within shaded area

For electrical and gas supply please see single installation requirements. Placement within the opening may require additional cabinet depth.

24" Microwave Drawer + 24" Electric Ceramic Cooktop

Flush installation

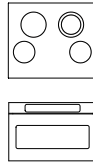

PE244CER

MD24X

TOP VIEW – COOKTOP DETAIL

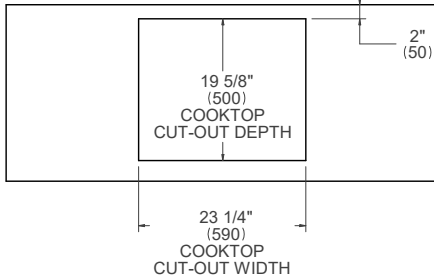

TOP VIEW – OVEN DETAIL

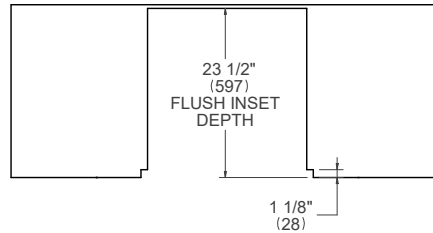

SIDE VIEW

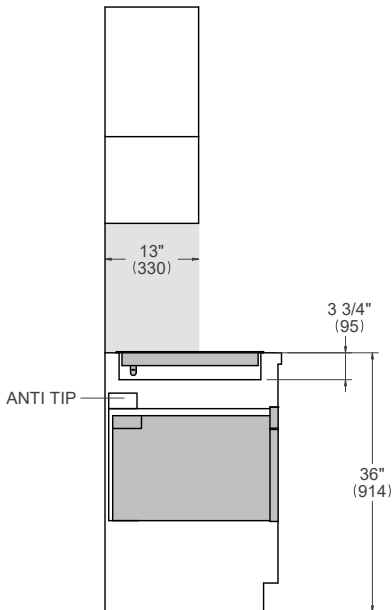

FRONT VIEW

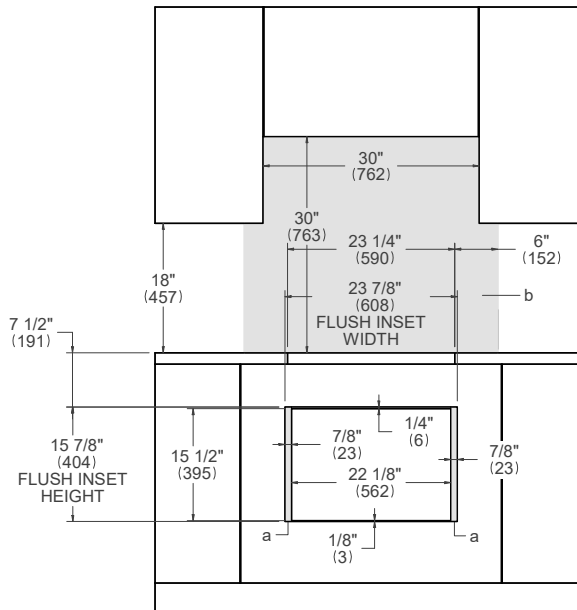

- (a) Visible Area - Match finish to outside cabinet panels
- (b) Combustible material cannot be installed within shaded area

For electrical and gas supply please see single installation requirements. Placement within the opening may require additional cabinet depth.

BERTAZZONI.COM



TO COOK BEAUTIFULLY