BERTAZZONI PROFESSIONAL SERIES

30" DROP-IN LOW EDGE COOKTOP 4 BURNER QB30 4 00 X



The Bertazzoni drop-in gas cooktop brings professional performance and surface cooking convenience together in an elegant solution. Available in this 30-inch size, the Bertazzoni Pro gas cooktops has the same onepiece, seamless, high-efficiency worktop design that has become the signature of Bertazzoni freestanding ranges. All burners are in cast brass for enhanced performance, with the dual zone brass power burner delivering best-in-class heat-up times and maximum flexibility thanks to its wide BTU range.

BRASS POWER BURNER



Bertazzoni's exclusive dual zone power burner in cast brass delivers high-efficiency performance from a delicate low simmer to full power (750 – 18,000 BTUs) with best-in-class heat-up time.



TO COOK BEAUTIFULLY

BERTAZZONI PROFESSIONAL SERIES

30" DROP-IN LOW EDGE COOKTOP 4 BURNER QB30 4 00 X

FEATURES

Brass burners	4
Dual wok (1x)	750-18000 Btu/h
Rapid (1x)	11000 Btu/h
Semi-rapid (1x)	6500 Btu/h
Auxiliary (1x)	3400 Btu/h
Simmer rate	750 Btu/h
Maintop	stainless steel
Worktop controls	knobs
Knobs	solid metal
Grates	cast iron
One hand ignition	yes
Wok adapter	yes
Simmer ring	yes

TECHNICAL SPECIFICATIONS

Electrical Requirements	120 V 60 Hz
Max Amp usage, power rating	1 A - 1 W
Certification	CSA
Warranty	2 years parts and labor

ACCESSORIES

Simmer ring (standard)	code 408077
Stainless steel griddle (optional)	code SG36X
Wok ring (standard)	code 408117

A LP conversion kit for all burners is included

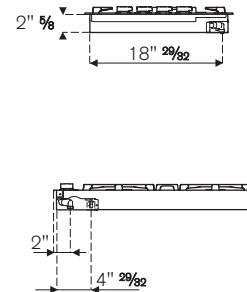
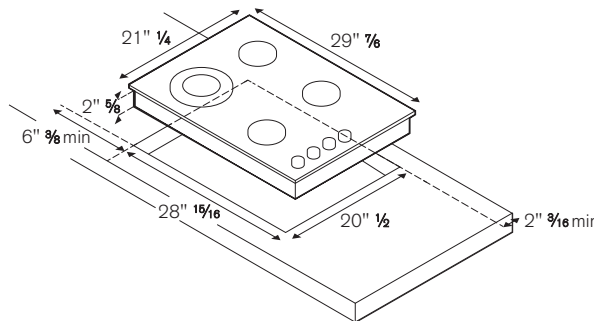

INSTALLATION INSTRUCTIONS

Bertazzoni recommends to operate the appliance after it has been installed in a cabinet.

The kitchen cabinets shall be made of materials capable of withstanding temperatures at least 117°F (65°C) above room temperature in order to avoid possible damage to the cabinets during appliance usage.

Disclaimer: while every effort has been made to insure the accuracy of the information contained in this brochure, Fratelli Bertazzoni reserves the right to change any part of the information at any time without notice.

Fratelli Bertazzoni, Bertazzoni and the winged wheel brand icon are registered trademarks of Bertazzoni Spa.