

PRODUCT DIMENSIONS

SIDE VIEW

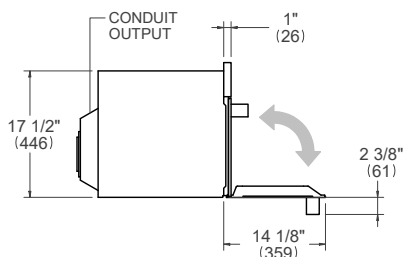

FRONT VIEW

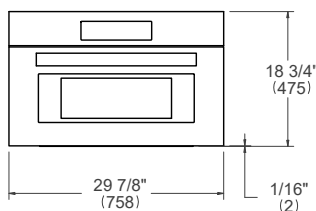

TOP VIEW

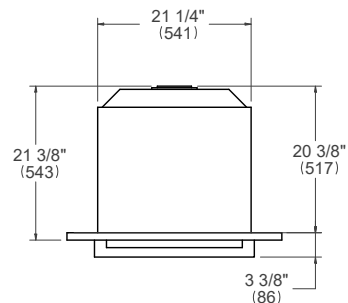

ELECTRICAL CONNECTION

FRONT VIEW

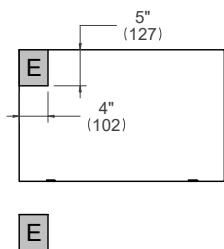

For single ovens installed into a wall cabinet, the electrical junction box may be located above, below to the left or right of the unit within reach of the power cord. Placement within the opening may require additional cabinet depth.

INSTALLATION REQUIREMENTS

Minimum suggested load on cabinet base board is 110 lb (50 kg)

CUTOUT DIMENSIONS

SIDE VIEW

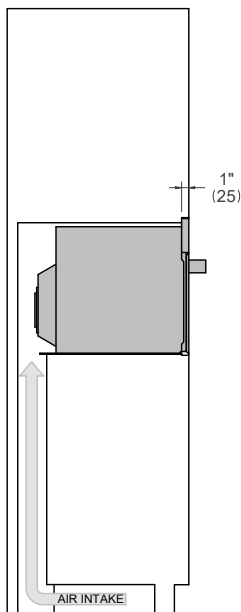

TOP VIEW

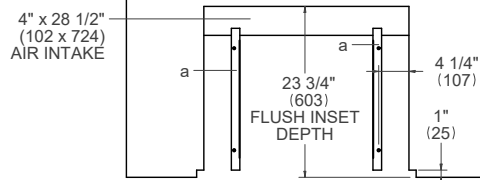

FRONT VIEW

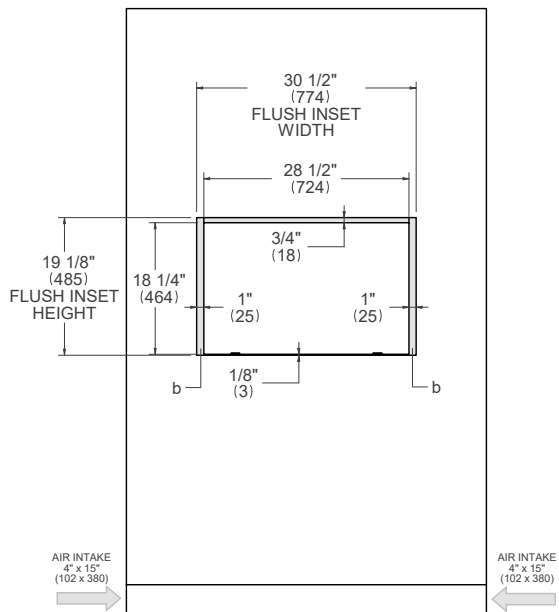

- (a) Spacers – Included with appliance
- (b) Visible Area – Match finish to outside cabinet panels