

---

# BERTAZZONI DESIGN SERIES

## 36" WALL MOUNT HOOD KG36 CON X



The Bertazzoni Design Series hood offers a sleek and elegant style with stainless steel framed glass and electronic touch through glass controls. It is a perfect match for the Bertazzoni Design Series wall ovens and segmented cooktops. Available with an efficient yet quiet 600 CFM motor and stainless-steel baffle filters, it can be installed for recirculation or ducted extraction.

### CONTROLS



Use the touch control interface that lets you adjust the 3 different power levels with just the touch of a finger.



TO COOK BEAUTIFULLY

# BERTAZZONI DESIGN SERIES

## 36" WALL MOUNT HOOD KG36 CON X

### FEATURES

<b>Blower</b>	1-3 speed
<b>Halogen lights</b>	2
<b>Filters</b>	baffle stainless steel
<b>Distance from worktop</b>	25 1/2"
<b>Motor power</b>	600 cfm

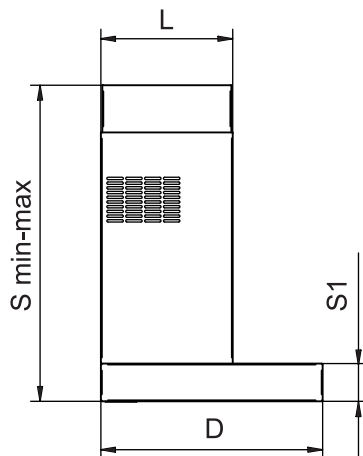
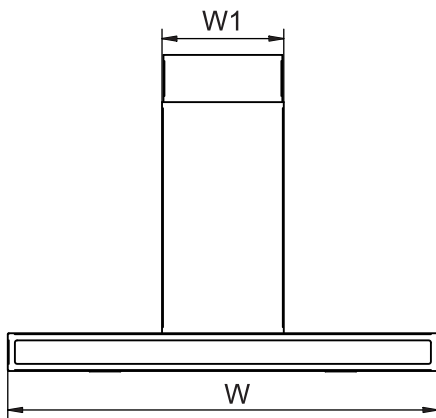
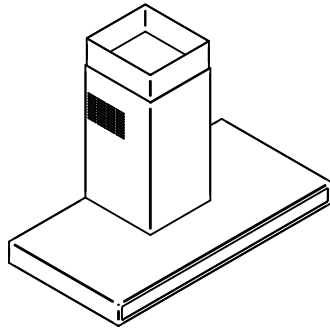

### TECHNICAL SPECIFICATIONS

<b>Electrical Requirements</b>	120V 60Hz
<b>Max. Amp Usage</b>	3.3 Amp
<b>Controls</b>	Full touch
<b>Certification</b>	CSA
<b>Warranty</b>	2 years parts and labor
<b>Product weight</b>	60.6 lbs
<b>Box weight</b>	63.6 lbs

### ACCESSORIES

<b>Recirculation kit (optional)</b>	code 901154
-------------------------------------	-------------

### DIMENSIONS

Ref.	Description	Dimensions	
		Inches	mm
<b>D</b>	Hood max depth	18 1/2	470
<b>L</b>	Duct cover depth	11	280
<b>S<sub>(min)</sub></b>	Hood height min	19 9/32	490
<b>S<sub>(max)</sub></b>	Hood height max	33 3/32	840
<b>S1</b>	Hood control panel height	3 1/8	80
<b>W</b>	Hood width	35 7/8	911
<b>W1</b>	Duct cover width	10 9/16	260

### INSTALLATION INSTRUCTIONS

Bertazzoni recommends to operate the appliance after it has been properly installed. Please refer to the installation manual for further details.