

# CATTURA™ DOWNDRAFT MODELS D49M30SB, D49M36SB, D49M48SB, D49M30BLS, D49M36BLS

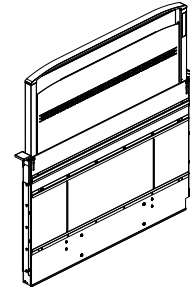

Powerful VERTEX™ Complete Capture Design rivals the finest island hoods. Compact design allows the choice of many cooktop styles, free-standing and built-in ranges for island or wall applications.

**FEATURES**

**HOUSING:**

- Galvanized steel construction
- Left, right, front, below or rear discharge
- Flexible installation - can be used with cooktops, rangetops, slide-in, and free-standing ranges
- 30", 36", or 48" widths - Fits standard-size cabinets (Some blower configurations may require deeper cabinets.)
- For indoor domestic use only

**CHIMNEY ASSEMBLY:**

- Quiet actuation linear drive system
- Chimney rises 18" when activated - ideal for tall pots
- Aluminum mesh filters - easy to remove, dishwasher-safe
- 304 stainless steel chimney - makes cleanup quick and easy
- 4-speed capacitive-touch control, with delay off and filter clean reminder
- Heat Sentry™ adjusts speed of blower in case of excess heat
- 2-level LED task light. 7W (30"), 14W (36"), 18W (48")
- Up to 100% capture - equal to comparable island hoods

**TRIM / DOOR:**

- Low profile
- 304 stainless steel construction
- Articulating door to hide chimney when retracted
- Integrated, capacitive-touch UP button

**BLOWER (sold separately):**

- Compatible with quiet and efficient 600 cfm Flex Blower - Model PF6
  - Permanently lubricated, thermally-protected motor
  - Neoprene, resilient anti-vibration mounts
  - Can be mounted directly to downdraft or mounted remotely
  - Uses standard 8" or 10" round duct
  - Can be rotated on housing to exhaust left, right or down
  - Compatible with in-line/exterior blower models: EB6, EB9\*, EB12\*, EB15\*, ILB3, ILB6, ILB9, ILB11\*
- \*Recommended models*

**TYPICAL SPECIFICATION**

Downdraft blower system shall be Best® Model D49M30SB, (D49M36SB), (D49M48SB), (D49M30BLS) or (D49M36BLS).  
Unit to have stainless steel housing. Chimney to rise 18" and have 304 stainless steel construction for ease of cleaning.  
Filters to be aluminum mesh, easy to remove and dishwasher-safe.  
Flex blower will connect directly to 8" round duct. Remote blower will connect directly to 10" round duct. Blower to discharge left, right, front, below or rear.  
Motor shall be mounted to blower assembly with grease resistant anti-vibration mounts, be removable, and lifetime lubricated.  
Unit to include Heat Sentry™, to adjust blower speed in case of excess heat.  
Unit to include trim / door to hide chimney when retracted.  
Downdraft system shall operate on 120 VAC and be able to be plugged into a standard grounded outlet. It will have a 4-speed blower control, with delay off, and filter clean reminder.  
Downdraft shall include 2-level LED task lighting.  
Downdraft blower system to be cULus listed.

**SPECIFICATIONS**

Volts: 120  
Hz: 60  
Amps: 3.2  
Duct: 8" or 10" Round



NOTE: Dimensions shown are for reference only. Before cutting out countertop, refer to instructions packed with downdraft and cooktop.

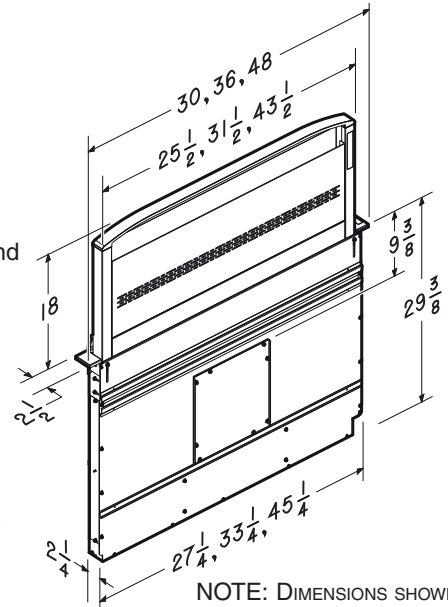

NOTE: DIMENSIONS SHOWN ARE IN INCHES.

BEST Hartford, Wisconsin www.BestRangeHoods.com 800-558-1711  
BEST Drummondville, QC, Canada www.BestRangeHoods.ca 866-737-7770

REFERENCE	QTY.	REMARKS	Project
			Location
			Architect
			Engineer
			Contractor
			Submitted by Date

**CABINET CUTOUTS**



**CAUTION: BEFORE CUTTING HOLE IN CABINET FOR DUCTWORK, check for interference with floor joists, wall studs, electrical wiring or plumbing.**

**Below, Side or Rear Ducting Cutouts**

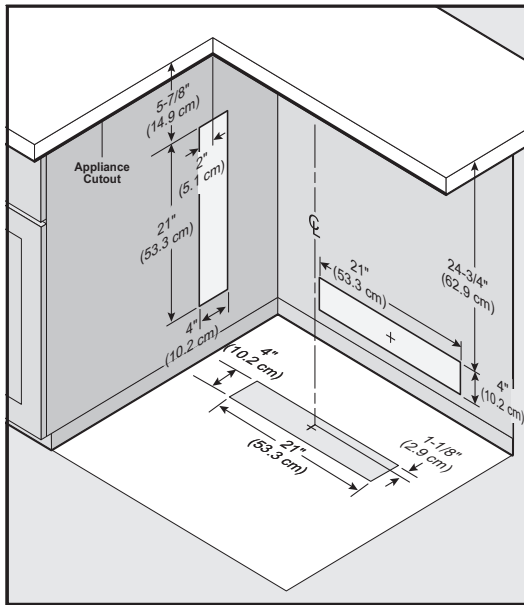

**Flex Blower Ducting Cutout**

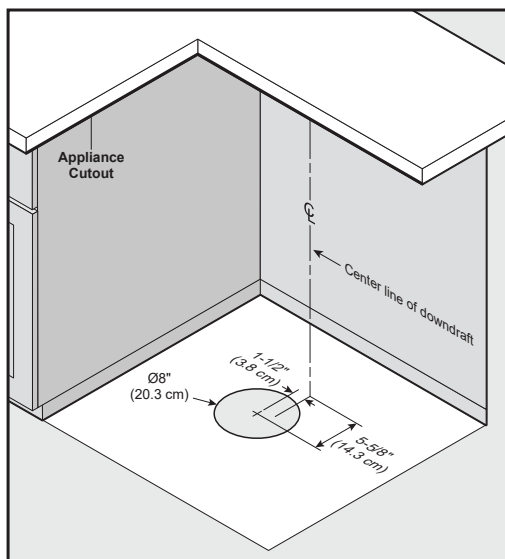

**Flex Blower Ducting – Remote Location Cutout**

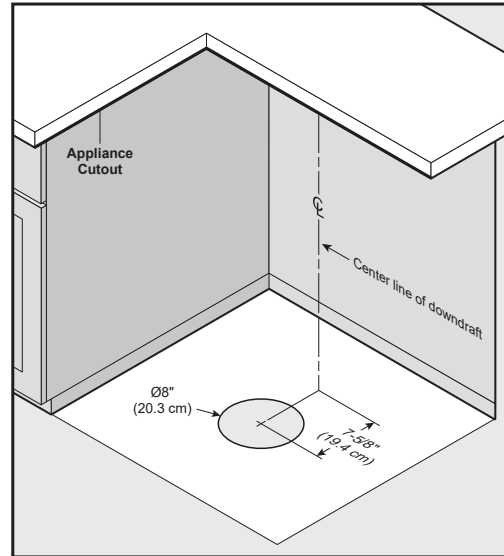

*Dimensions based off of Model 432 - 8" round elbow*

**10" Exterior or In-line Blower Ducting Cutout**

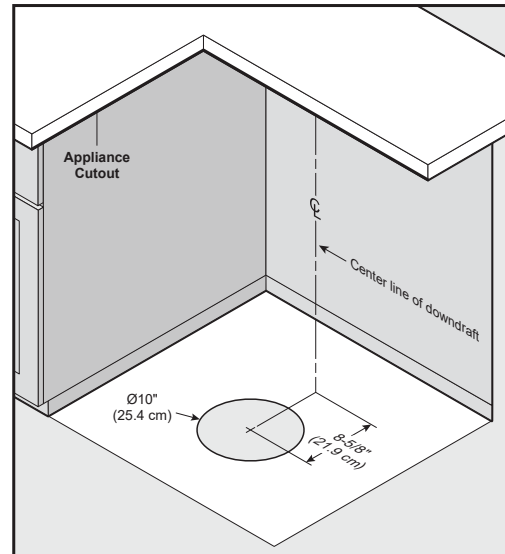

*Dimensions based off of Model 418 - 10" round elbow*

Use the dimensions in illustrations to help plan how and where to provide duct access through your cabinet. A 1-7/8" x 19" rectangular duct can be used through left, right, floor and back of cabinet. Also, 8" round or 10" round can be used through cabinet floor.

**For left, right, or rear exhaust:**

Allow at least 18" for transition and elbow or blower.

**For left / right exhaust:**

A 30" deep cabinet is recommended to align properly with flex blower. Flex blower can be mounted to rear cabinet wall or to a platform / frame (not provided) on the base of the cabinet floor. (See flex blower instructions).

Cabinet depths of 24" to 30" are required - depending on the type of cooking appliance.

## ELECTRICAL PANEL

The unit has a 30-in. power cord with a 3-pronged plug. Plan to provide a grounded outlet within reach of this cord.

## DOWNDRAFT

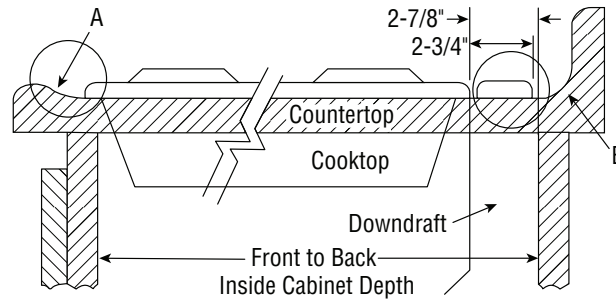

Refer to the cooktop installation instructions for dimensions of cooktop, countertop cut-out, and cabinet requirements. However, it is recommended that oversized cabinets be used for easier installation. Custom island designs need to account for deeper cabinets - especially when installed with a range in front of the downdraft or when mounting the blower behind the downdraft. You must also plan for an access door.

Cooktop depth can vary greatly from one to another. This may cause the fit of these two appliances to be rather tight.

Pay special attention to the areas of potential interference highlighted above. A countertop with (A) a raised lip and/or (B) a backsplash may not allow enough flat countertop for a proper installation. Note that 2-3/4" of flat countertop is required behind cooktop and that 2-7/8" is necessary between the back edge of the cooktop and the inside of cabinet back.

## DUCTWORK

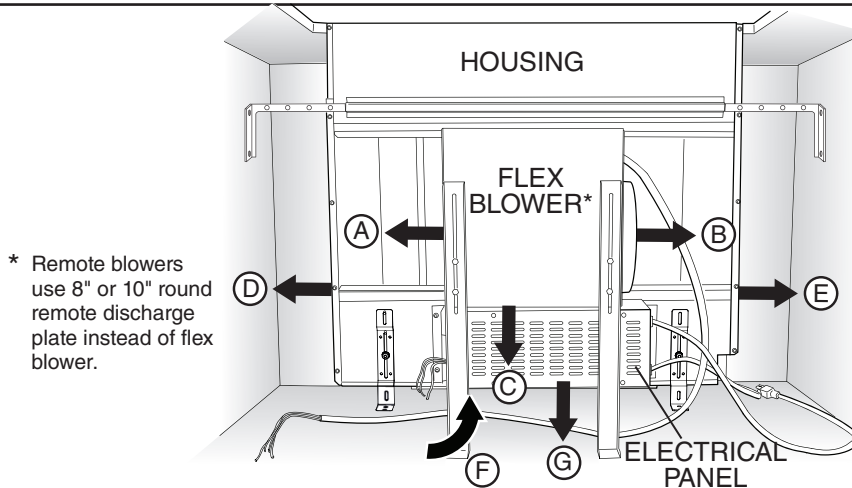

The downdraft blower system is designed for use with 8" round ductwork using a Flex Blower or 10" round ductwork using a remote blower. (Purchase blowers separately.) Seven (7) different discharge connections are available - with side-to-side adjustment for accurate alignment of ductwork:

- A = 8" Round, Left Discharge out of Flex Blower
- B = 8" Round, Right Discharge out of Flex Blower
- C = 8" Round, Down Discharge out of Flex Blower (Electrical Panel to be mounted remotely)
- D = 1-7/8" x 19", Left Discharge out of Housing to Remote Blower or Flex Blower in remote location. Use 1-7/8" x 19" to 8" round transition, 1-7/8" x 19" to 10" round transition, or 1-7/8" x 19" ductwork as appropriate.
- E = 1-7/8" x 19", Right Discharge out of Housing to Remote Blower or Flex Blower in remote location. Use 1-7/8" x 19" to 8" round transition, 1-7/8" x 19" to 10" round transition, or 1-7/8" x 19" ductwork as appropriate.
- F = 1-7/8" x 19", Rear Discharge out of Housing to Remote Blower or Flex Blower in remote location. Use 1-7/8" x 19" to 8" round transition, 1-7/8" x 19" to 10" round transition, or 1-7/8" x 19" ductwork as appropriate.
- G = 1-7/8" x 19", Below Discharge out of Housing to Remote Blower or Flex Blower in remote location. Use 1-7/8" x 19" to 8" round transition, 1-7/8" x 19" to 10" round transition, or 1-7/8" x 19" ductwork as appropriate.

For best performance: Choose the ducting option which allows the shortest length of ductwork and a minimum number of elbows and transitions. Check location of floor joists, wall studs, electrical wiring or plumbing for possible interference.

OPTIONAL ACCESSORY	DESCRIPTION / APPLICATION
--------------------	---------------------------

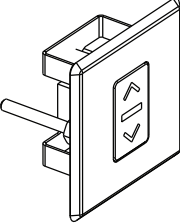
 <p><b>MODELS</b> ACRD ACRDBLS</p>	<p><b>REMOTE UP/DOWN CONTROL</b></p> <p>Use when you cannot reach the UP/DOWN Button on the downdraft chimney.</p> <p>Can be located on counter top, face of cabinetry or on the side cabinet of an island. Cut-out size: 2¼" H x 2" W.</p> <p>Cannot be used where remote control will interfere with cooking, where hot pans could be set, or where hot liquids could be spilled on the control.</p> <p>Remote wiring connects with 6-pin connection.</p>
---	---

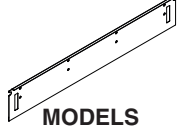
 <p><b>MODELS</b> ATSKD30 ATSKD36 ATSKD48</p>	<p><b>GAS COOKTOP SEAL KIT</b></p> <p>Recommended for use with all gas cooktops. Includes trim bracket and trim seal.</p> <p>30", 36" &amp; 48" widths.</p>
--	---

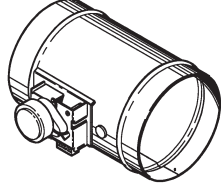
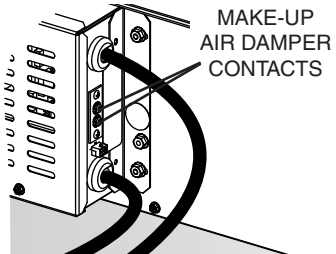
 <p><b>MODELS</b> MD6T MD8T MD10T</p>	<p><b>MAKE-UP AIR DAMPER</b></p> <p>Use to provide make-up air (when called for) to keep the home comfortable by allowing the downdraft to operate at optimum levels.</p> <p>Directwire design works with select BEST® downdrafts to balance indoor air pressure by providing interlocked make-up air; damper opens automatically when the range hood is activated.</p> <p>8" &amp; 10" round diameters.</p> <p>Connects to 2 CONTACTS on ELECTRICAL PANEL.</p>  <p>MAKE-UP AIR DAMPER CONTACTS</p>
--	--

 <p><b>MODELS</b> ATKD30SB, ATKD30BLS ATKD36SB, ATKD36BLS ATKD48SB</p>	<p><b>RANGE TRIM KIT</b></p> <p>Use with free-standing range - where a gap is present between back of range and downdraft.</p> <p>30", 36" &amp; 48" widths.</p>
---	--

OPTIONAL ACCESSORY	DESCRIPTION / APPLICATION
--------------------	---------------------------

 <p><b>MODEL AEWD5</b></p>	<p><b>EXTENSION CABLE - 5-FT.</b></p> <p>Use where electrical panel is remotely mounted. Extends electrical panel cable an additional 5 feet.</p>
--	---

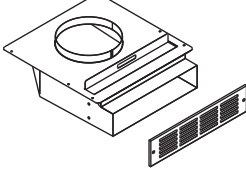
 <p><b>MODEL ANKD</b></p>	<p><b>NON-DUCT RECIRCULATING KIT</b></p> <p>Use where ducting is not feasible or available. Mount to toe kick or base of a cabinet and attach directly to Model PF6 Flex Blower using 8" round duct. Kit can be rotated so that the exhaust is not directly at your feet. Includes recirculation filter and decorative cover plate.</p>
---	---

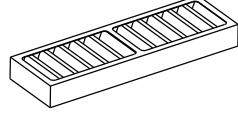
 <p><b>MODEL AFCD</b></p>	<p><b>RECIRCULATION FILTER REPLACEMENT</b></p> <p>Replacement filter for ANKD Non-Duct Recirculating Kit. Use to effectively capture cooking contaminants.</p>
--	--

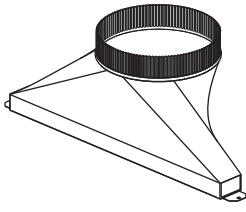
 <p><b>MODEL AVDKD8</b></p>	<p><b>1-7/8" X 19" TO 8" ROUND TRANSITION</b></p> <p>Rectangular to 8" round transition for left, right, below or rear exhaust - using Model PF6 Flex Blower. Can be attached to downdraft unit or rectangular duct (AEDD2). Includes S-clips for easy, secure attachment.</p>
---	--

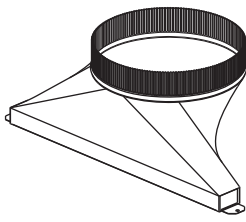
 <p><b>MODEL AVDKD10</b></p>	<p><b>1-7/8" X 19" TO 10" ROUND TRANSITION</b></p> <p>Rectangular to 10" round transition for left, right, below or rear exhaust - using external blower. Can be attached to downdraft unit or rectangular duct (AEDD2).</p>
--	--

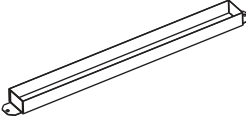
 <p><b>MODEL AVDKD219</b></p>	<p><b>RECTANGULAR ADAPTER FOR 1-7/8" X 19"</b></p> <p>Use to connect 1-7/8" x 19" rectangular duct directly to downdraft when using side, below or rear exhaust.</p>
---	--

OPTIONAL ACCESSORY	DESCRIPTION / APPLICATION
--------------------	---------------------------

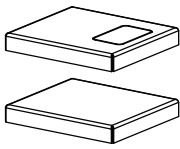
 <p><b>MODELS</b> ATTD1 ATTD1BLS</p>	<p><b>END CAP TRIM EXTENSION +1" WIDTH - LH &amp; RH</b></p> <p>Use left and right to increase the overall trim width by 1".</p>
---	--

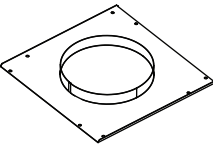
 <p><b>MODEL ACVPD8</b></p>	<p><b>FRONT PANEL ROUGH-IN PLATE - 8" ROUND</b></p> <p>Use where 8" round duct or elbow attaches to front of airbox (Model PF6 remote blower installation).</p>
--	---

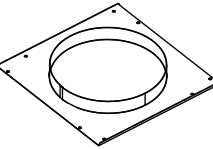
 <p><b>MODEL ACVPD10</b></p>	<p><b>FRONT PANEL ROUGH-IN PLATE - 10" ROUND</b></p> <p>Use where 10" round duct or elbow attaches to front of airbox (exterior or in-line blower installation).</p>
--	--

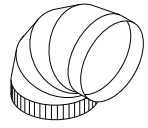
 <p><b>MODEL 432 - 8" RD.</b> <b>MODEL 418 - 10" RD.</b></p>	<p><b>90° DUCTWORK ELBOW</b></p> <p>Adjustable from straight to 90°. Galvanized steel construction.</p>
---	---

 <p><b>MODEL 408 - 8" RD.</b> <b>MODEL 410 - 10" RD.</b></p>	<p><b>STRAIGHT ROUND DUCT - 2-FT.</b></p> <p>Galvanized steel construction.</p>
---	---

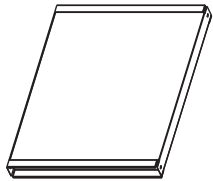
 <p><b>MODEL AEDD2</b></p>	<p><b>RECTANGULAR DUCT - 2-FT. SECTIONS (1-7/8" X 19")</b></p> <p>Galvanized steel construction.</p>
---	--

OPTIONAL ACCESSORY	DESCRIPTION / APPLICATION
--------------------	---------------------------

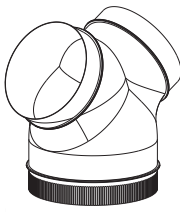
 <p><b>MODEL AVDKD8810</b></p>	<p><b>TRANSITION "Y" (2) - 8" ROUND TO (1) - 10" ROUND</b></p> <p>Galvanized steel construction.</p>
--	--

**MODELS ATTD1 OR ATTD1BLS**

End Cap Trim Extensions  
(Increases trim width 1-inch  
to 31, 37, or 49 inches.)

**MODEL ATKD30SB, 36, 48**

Range Trim Kit  
(Option to fill gap between  
range and downdraft.)

**MODEL ATSKD30, 36, 48**

Gas Cooktop Seal Kit  
(Recommended for use with  
gas cooktops.)

**MODELS ACRD OR ACRDBLS**

Remote Up/Down  
Control

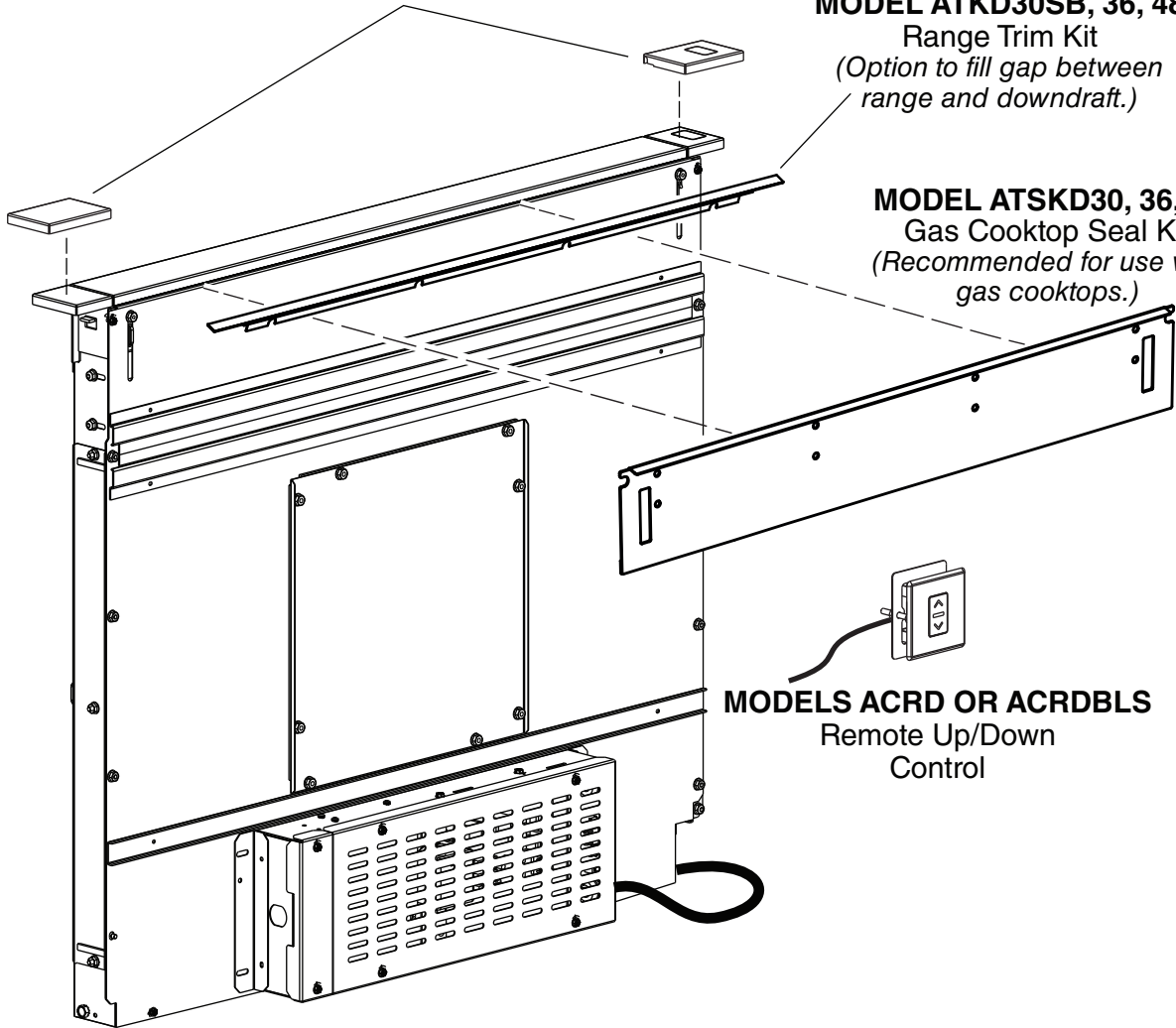

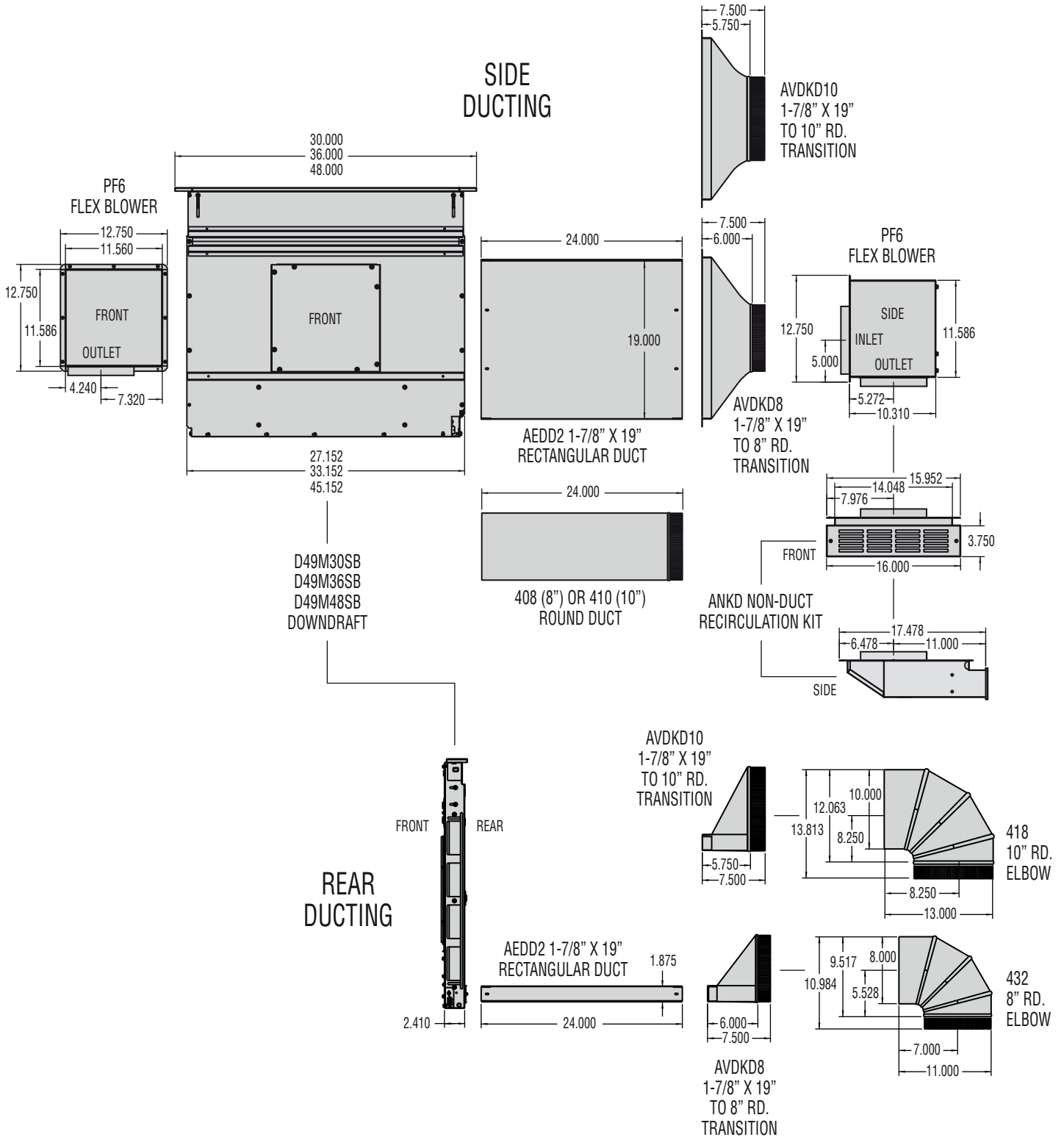

- Flex Blower (PF6) attached to front of Downdraft in cabinet
- Ducted to Wall Cap or Non-Duct Recirculation Kit

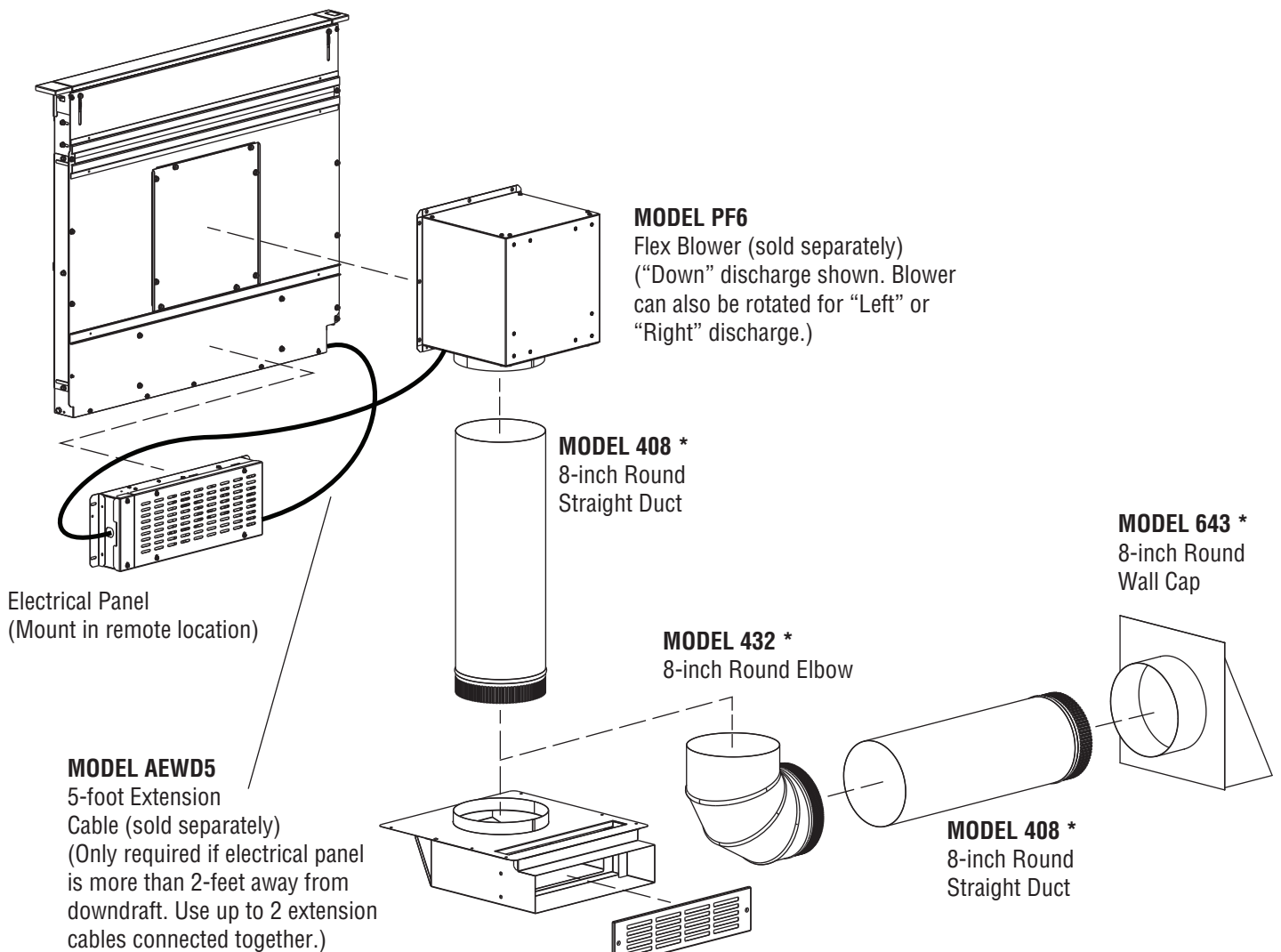
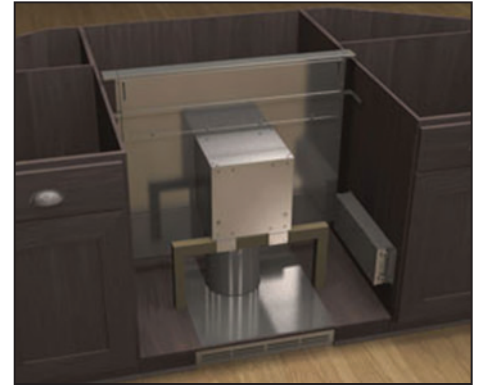

\* As required - sold separately.



- Ducting connected to front of Downdraft
- Flex Blower in cabinet - or - in remote, in-line location
- Ducted to Wall Cap

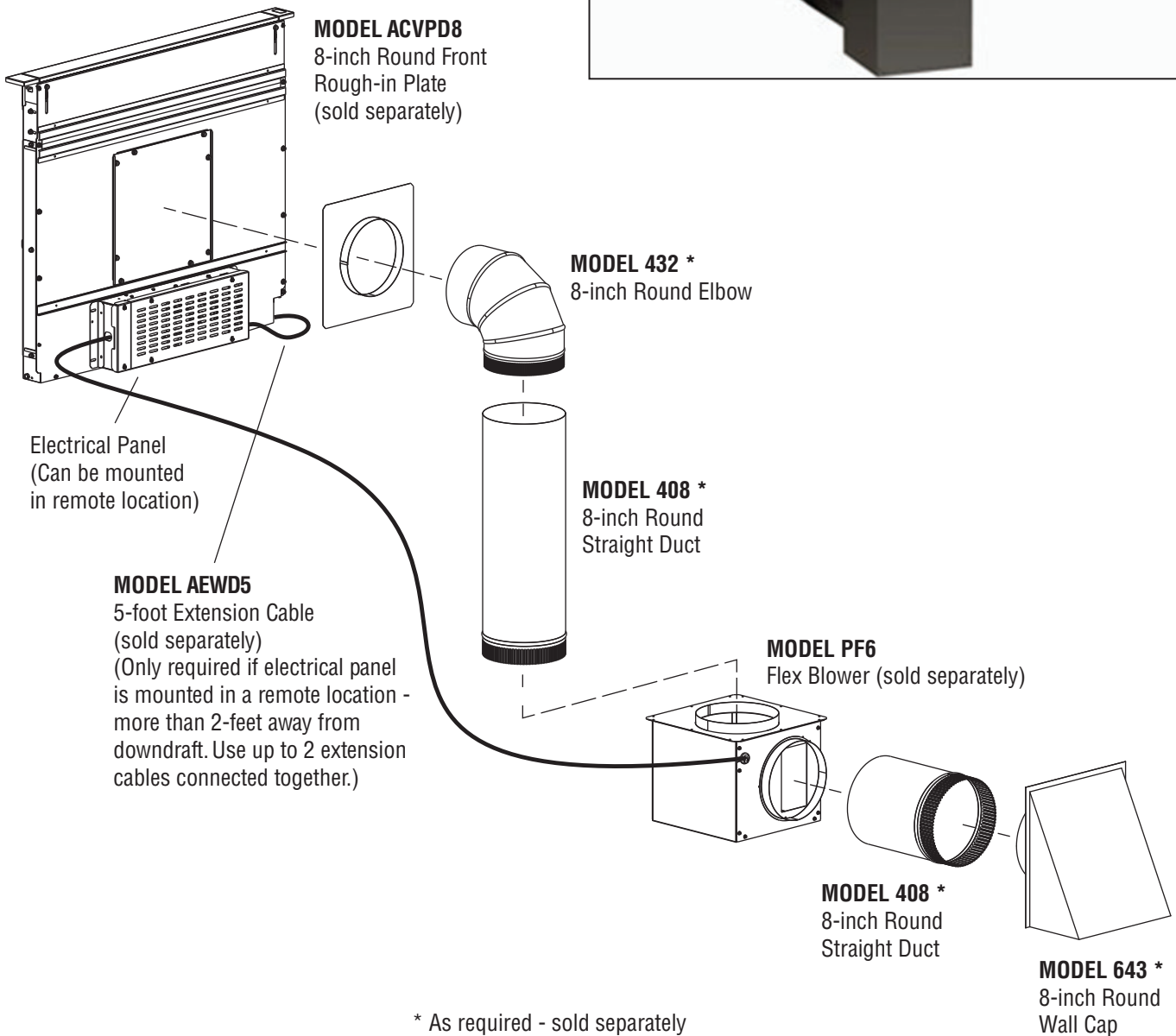

- Ducting connected to right side of Downdraft  
(Ducting connects to left side or rear of downdraft in same manner.)
- Flex Blower mounted in a side cabinet or other remote, in-line location
- Ducted to Wall Cap or Non-Duct Recirculation Kit

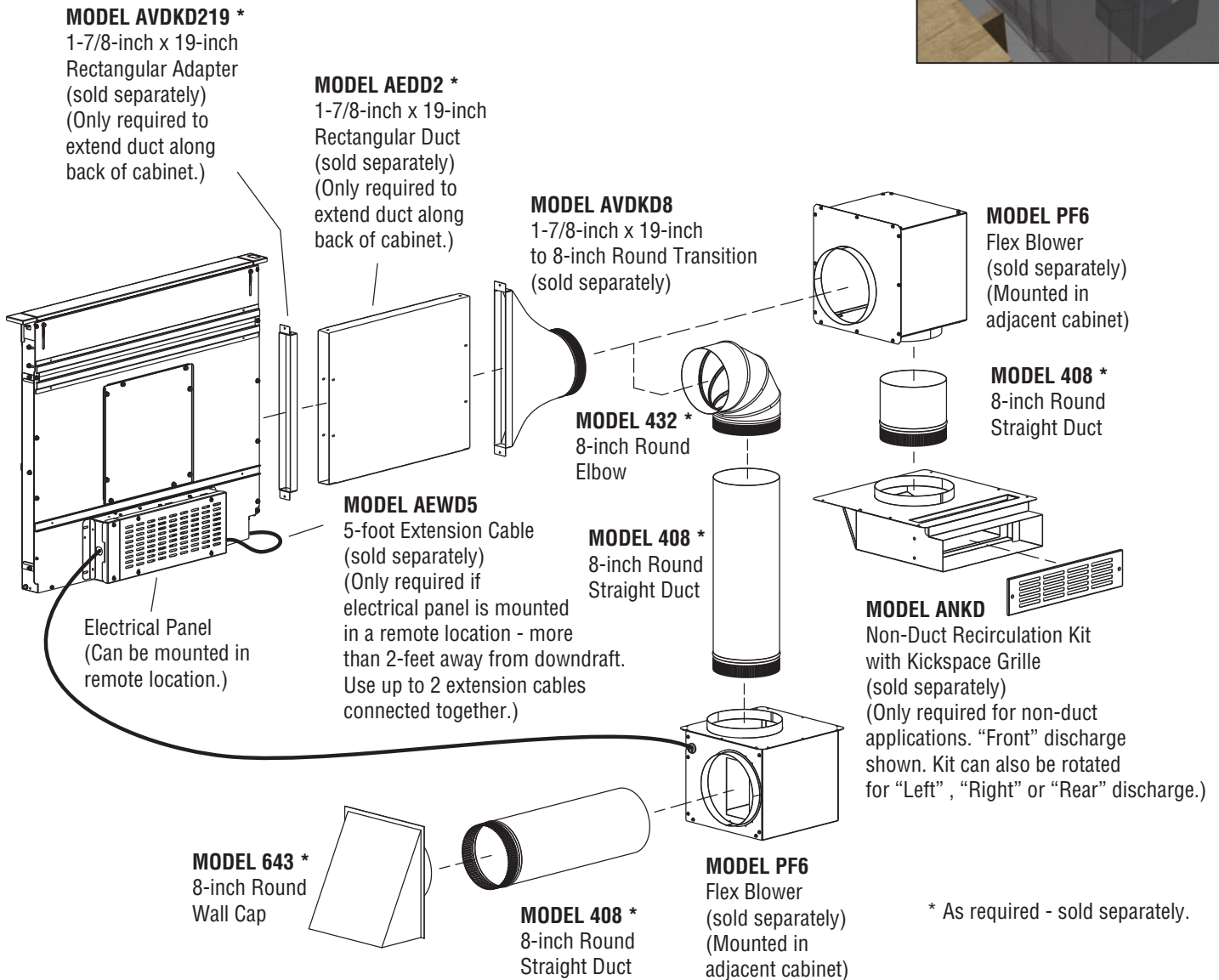
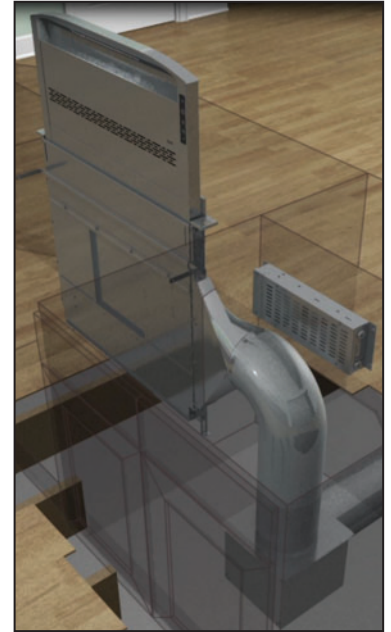

\* As required - sold separately.

- Ducting connected to rear of Downdraft
- Flex Blower in side cabinet or other remote, in-line location
- Ducted to Wall Cap or Non-Duct Recirculation Kit

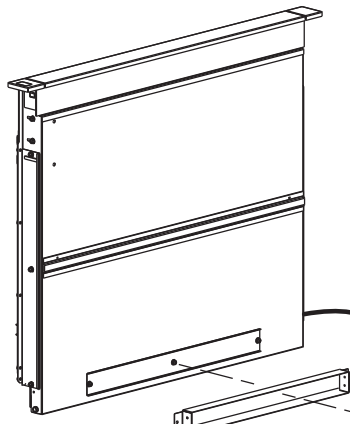
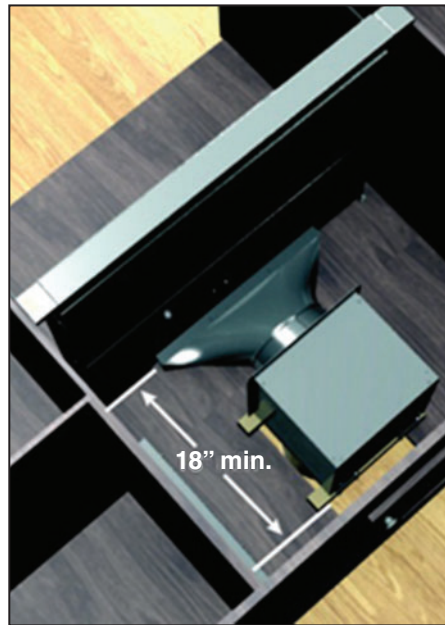

**MODEL AVDKD219 \***  
1-7/8-inch x 19-inch  
Rectangular Adapter  
(sold separately)

**MODEL AEDD2 \***  
1-7/8-inch x 19-inch  
Rectangular Duct  
(sold separately)

**MODEL AVDKD8**  
1-7/8-inch x 19-inch  
to 8-inch Round  
Transition  
(sold separately)

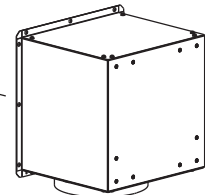
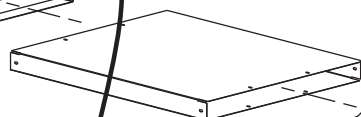

**MODEL PF6**  
Flex Blower  
(sold separately)  
(Mounted in  
adjacent cabinet)

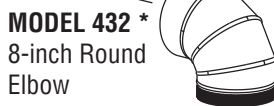

**MODEL 432 \***  
8-inch Round  
Elbow



**MODEL 408 \***  
8-inch Round  
Straight Duct



**MODEL 408 \***  
8-inch Round  
Straight Duct

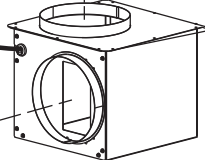

**MODEL PF6**  
Flex Blower  
(sold separately)  
(Mounted in  
remote location)

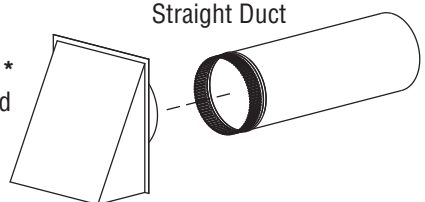

**MODEL 643 \***  
8-inch Round  
Wall Cap

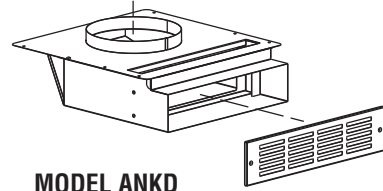

**MODEL ANKD**  
Non-Duct Recirculation Kit  
with kickspace grille  
(sold separately)  
(Only required for non-duct  
applications. "Front" discharge  
shown. Kit can also be rotated  
for "Left", "Right" or "Rear" discharge.)

\* As required - sold separately.

- Ducting connected below Downdraft
- Ducted to Wall Cap or Non-Duct Recirculation Kit

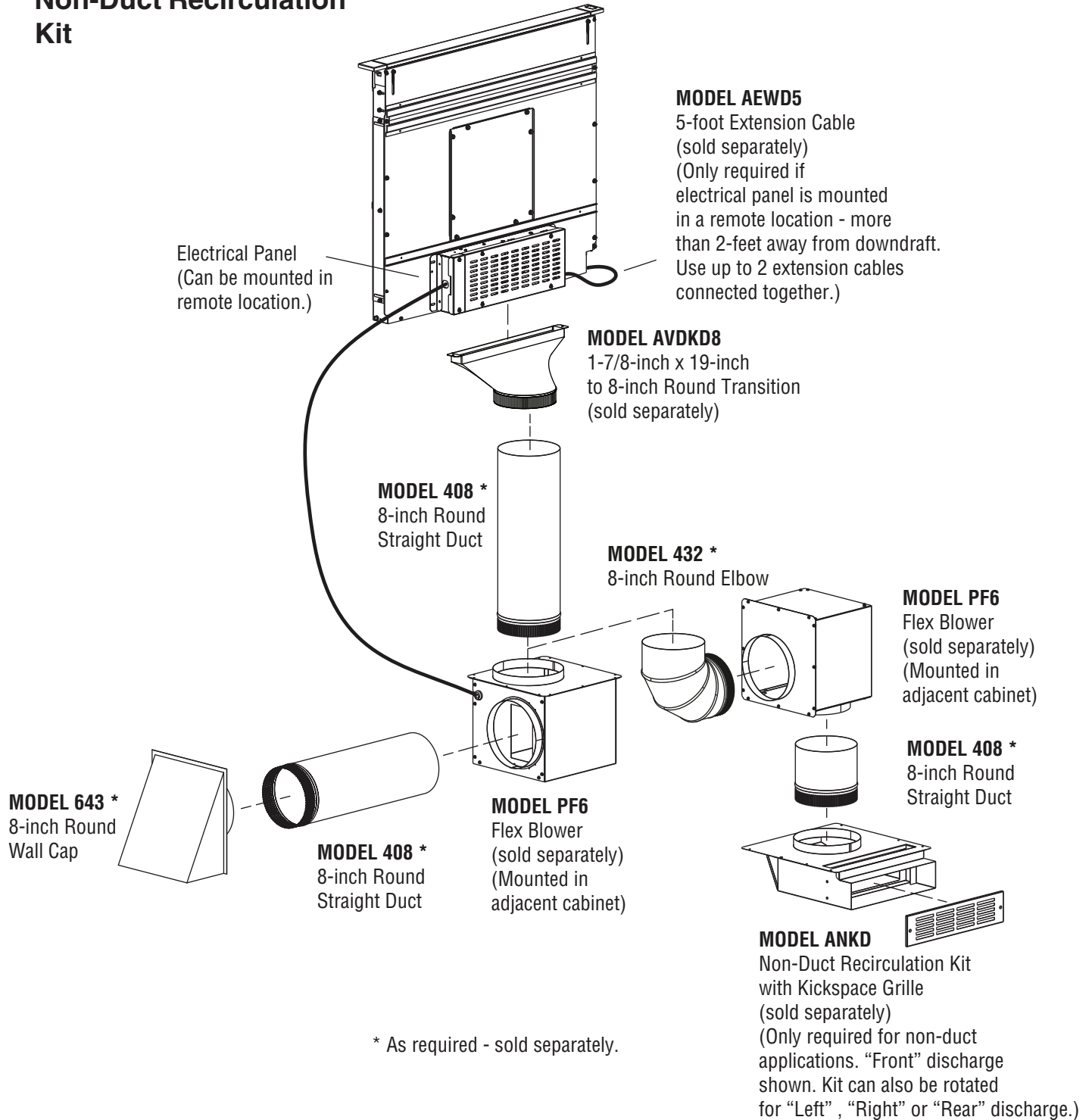

- EB15 Exterior Blower is recommended for all rangetops or cooktops with grill & any 48-inch wide rangetop or cooktop
- Ducting connected to front of Downdraft
- 10-inch round duct connected to In-Line or Exterior Blower

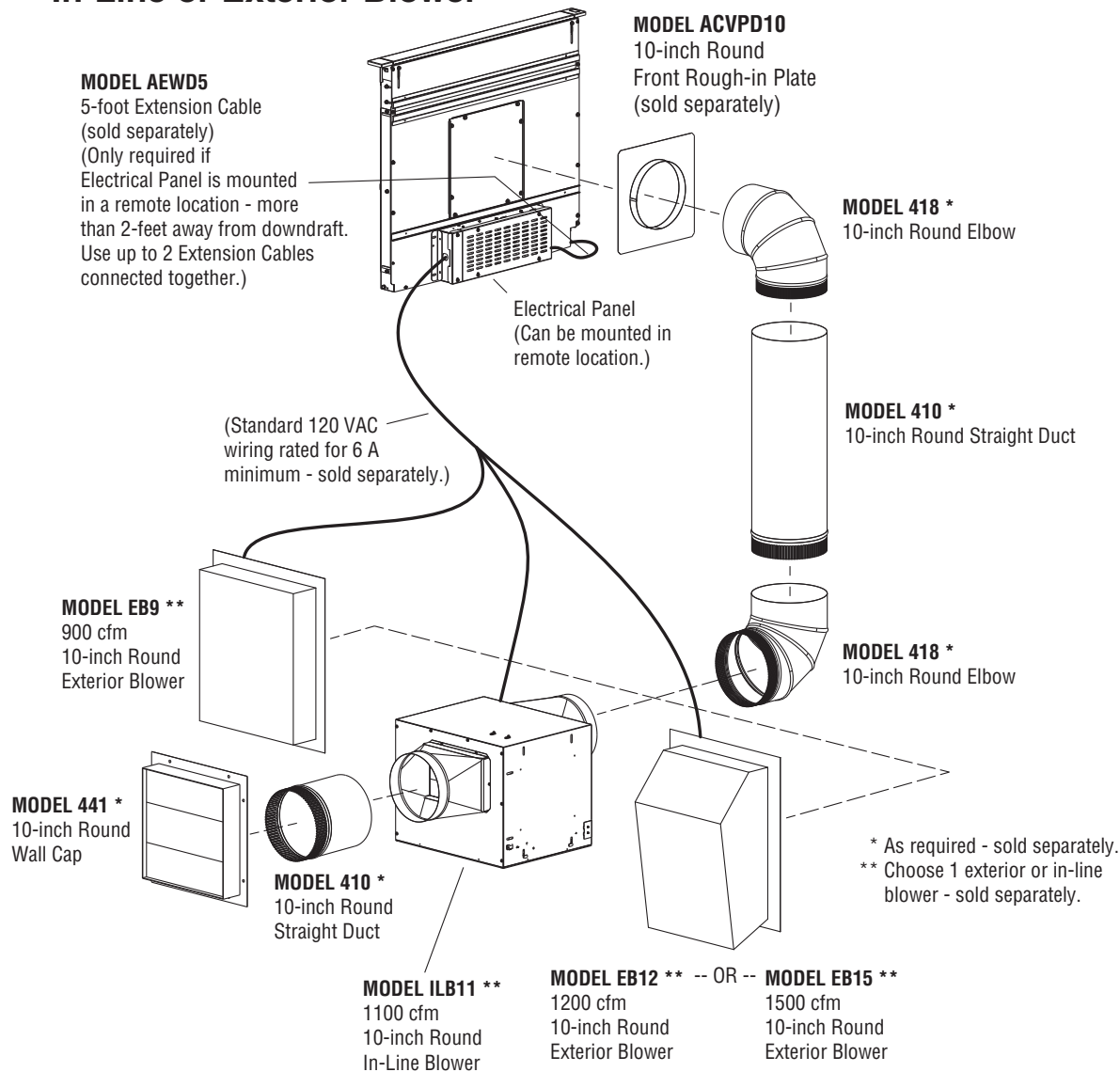

- EB15 Exterior Blower with dual duct (see page 16) is recommended for all rangetops or cooktops with grill & any 48-inch wide rangetop or cooktop
- Ducting connected to side or rear of Downdraft
- 10-inch round duct connected to In-Line or Exterior Blower

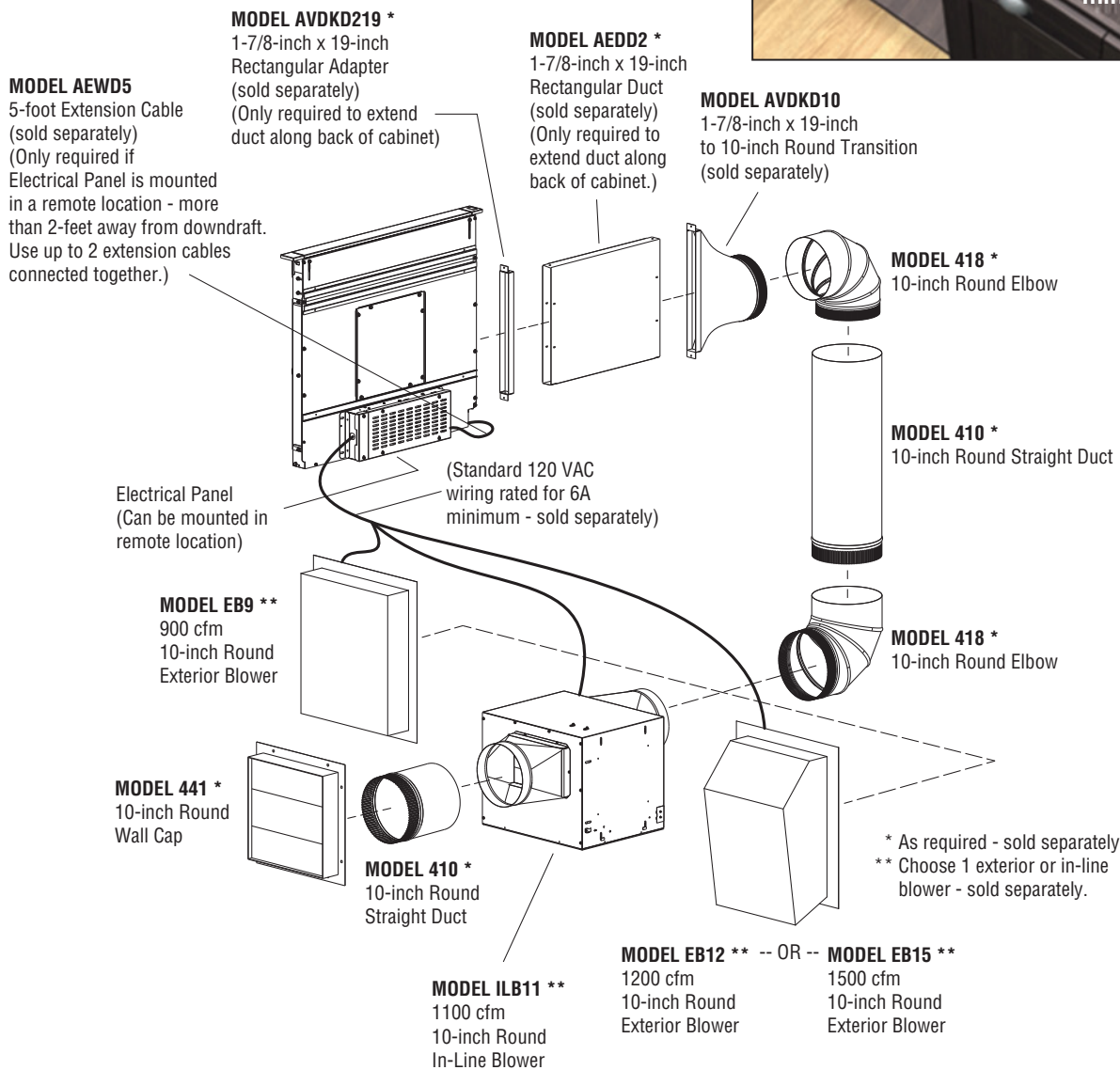
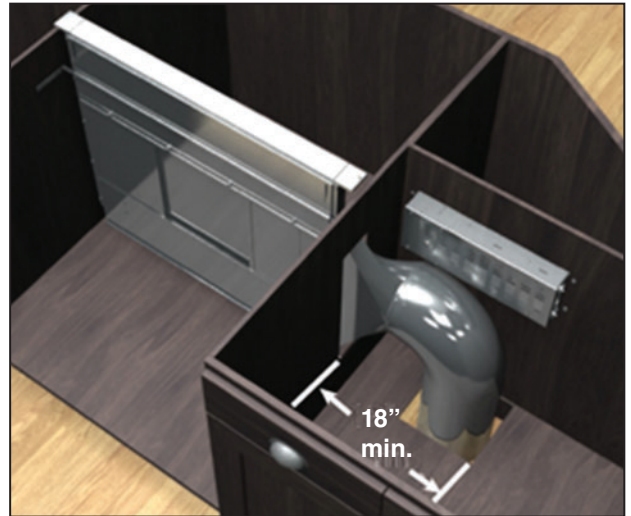

- EB15 Exterior Blower is recommended for all rangetops or cooktops with grill & any 48-inch wide rangetop or cooktop
- Ducting connected below Downdraft
- 10-inch round duct connected to In-Line or Exterior Blower

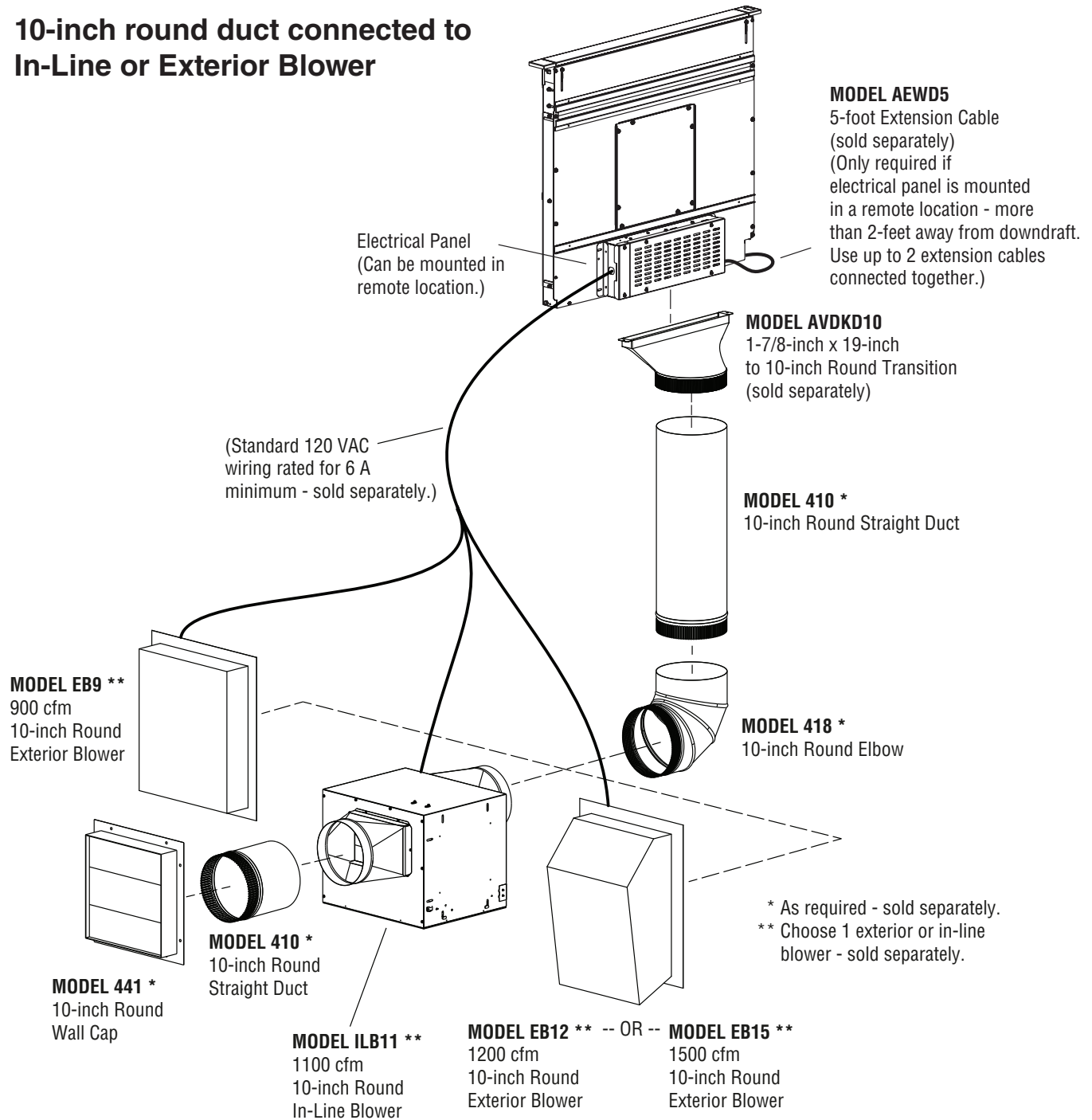

- EB15 Exterior Blower is recommended for all rangetops or cooktops with grill & any 48-inch wide rangetop or cooktop
- Ducting connected to right and left sides of Downdraft (Ducting may be connected to either side & rear of downdraft in same manner.)
- 8-inch round duct connected to Dual 8-inch to 10-inch round Transition
- 10-inch round duct connected to Exterior or In-Line Blower

