

**24 INCH FREESTANDING ELECTRIC RANGE****BERC24102SS / BERU24102SS****True European Convection**

Blomberg's advanced convection system features an additional dedicated heating element around the cooking fan to circulate warm air evenly, creating a three-dimensional cooking effect that works consistently on every rack. Roasts and casseroles cook faster and more uniformly. Baked goods are evenly browned and beautiful. Multiple dishes cook to perfection at the same time with no mixing of flavors or aromas.

**Large Oven Capacity**

Blomberg knows you can never have too much room in your oven, even if there's not a lot of room in your kitchen. That's why we engineered a generous 2.51 cu. ft. oven capacity into our 24-inch range.

Programmable Electronic Timer

Blomberg ovens feature electronic timers that show the time of day and allow you to preset the start time, duration, or end of cooking. When the set cooking time ends, the oven switches itself off automatically.

**Easy Clean Gray Enamel**

Blomberg 24-inch oven cavities are coated with a long-lasting, nonporous, gray enamel finish that is not only attractive but also extremely easy to clean. Just a simple wipe with a damp cloth is all it takes to remove fresh spills and keep your oven looking like new.

**Interior Lighting**

For full visibility while baking, braising, and roasting, Blomberg ovens feature bright interior lighting, including cylindrical lamps placed on the rear wall, and a non-reflective enamel surface that reduces glare on the glass oven door.



GENERAL	
Type	Freestanding
Size	24"
Finish	Stainless Steel
Side Walls	Black
Control Type	LED Display with Knob & Touch Control
Burner Color	Black
Knob Color	Stainless Steel
Fuel Type	Electric
FUNCTIONS	
True European Convection	Yes
Bake	Yes
Broil	Electric
Convection Broil	Yes
Convection Roast	Yes
Roast	Yes
3D Cooking	Yes
Defrost	Yes
FEATURES	
12/24-hour clock format	Yes
Oven Rack Positions	5
Oven Enamel Color	Gray
Interior Illumination	1 x Halogen Light
Adjustable Feet	Yes
Bottom Compartment	Storage Drawer
Oven Glass Window	Full Glass
Door Cooling System	3 Pane Heat Resistant Glass(fixed)
COOKTOP	
Burner Configuration	4 Vitroceramic
Front Left	8.3" / 4.7" - 2200 / 750 W (Duo)
Rear Left	6.3" - 1500 W
Front Right	5.5" - 1200 W
Rear Right	7" - 1800 W
Simmering	2.5 cu. ft.
Residual Heat Indicator	Yes
Display Lock	Yes
ACCESSORIES	
Island Trim	Included
Splash Back	Optional
Anti-Tip Bracket	Yes
Chromed Wire Racks	2
POWER RATINGS	
Volts / Frequency	120-240V 60Hz
Min. Amps (A)	40 A
Power Cord	4 prong power supply cord for Canadian Model (BERC24102SS) & Purchased separately for USA Model (BERU24102SS)
Plug Type	USA (Canadian Model_(BERC24102SS)
Bottom Heating Element	1200W
Upper Heating Element Outer:	2200W
Convection Element	1800W
Broil Power Consumption	Low Grill (Broil) 1100W / Grill (Broil) 2200W
DIMENSIONS/WEIGHT	
Required Cutout Dimensions - (H x W x D) Inches	36" x 24" x 24"
Product Dimensions - (H x W x D) Inches	36" x 23 9/16" x 25 3/4"
Product Dimensions - (H x W x D) cm	90 x 60 x 60.4 cm
Product Weight - lbs / kg	149.5 lbs / 68 kg



24 INCH FREESTANDING ELECTRIC RANGE

BERC24202SS / BERU24202SS

Dimensions and Installation

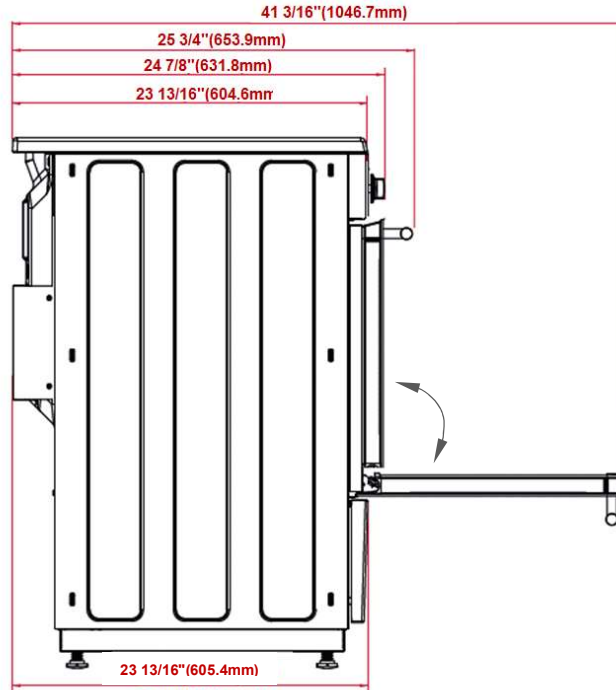
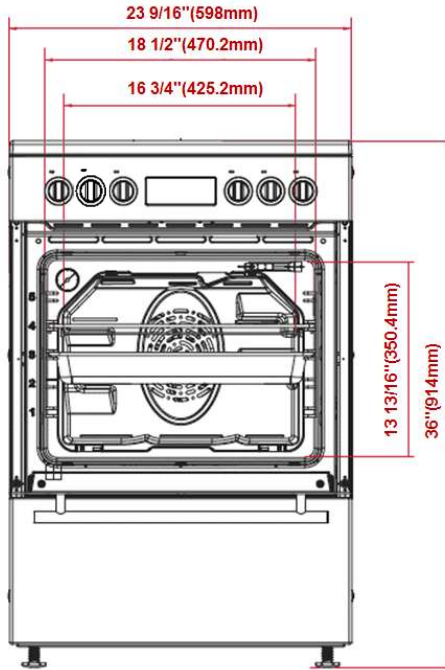

Cabinet

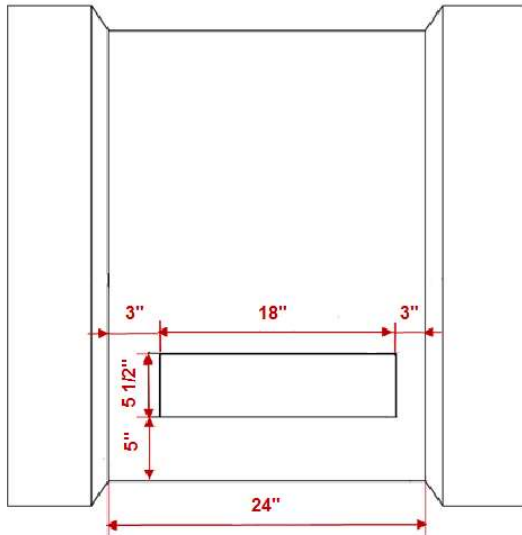

Required minimum air gap clearances: 1/4" sides

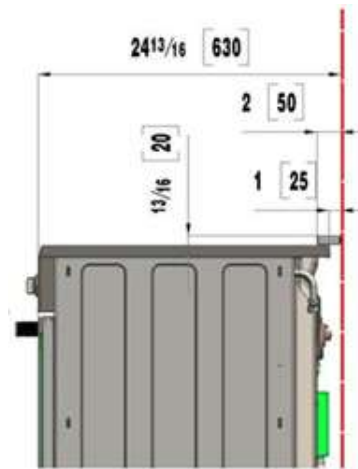

Island trim: standard comes with the range un-attached.
4" High Stainless Splash Back (optional)

NOTE TO THE INSTALLER: All height, width and depth dimensions are shown in inches (as well as metric). Beko US Inc. reserves the absolute and unrestricted right to change product materials and specifications, at any time, without notice. Please visit our website www.blombergappliances.com or call 888-352-2356 to verify the latest specifications with final dimensional data and other details prior to installation and making a cutout. Applicable product limited warranty information may be found in accompanying product materials or you may contact your account manager for further details. Proper installation is the responsibility of the installer. Product failure due to improper installation is not covered under the Limited Warranty.