



IN HARMONY WITH NATURE,
YOUR LIFE, AND YOU.

Blomberg
seit 1883

24" Tall Tub, Top Control Dishwasher

DWT81800 SERIES

Color Options: DWT81800SS(IH) Stainless Steel DWT81800FBI Panel Ready DWT81800SSWS Stainless Steel



PROGRAMS

- Pots and Pans+ (167°F)
- Auto Program (131–149°F)
- MixWash+ (131–149°F)
- Regular Wash (142–145°F)
- Daily Wash
- GlassCare
- Quick Wash (131°F)
- Sanitize Function
- SuperGloss Function
- RapidClean Function
- PowerWash Function with Extra Spray Arm
- Rinse & Hold

FEATURES

- Top Control
- 8 Cycles
- Silent Operation: 45 dBA
- Removable 3rd Rack
- Inner Illumination
- Stainless
- Flexible Rack Loading
- Power Wash
- MixWash+

FINISH

Fingerprint-free Stainless Steel

DIMENSIONS (H x W x D)

33⁷/₈ x 23⁹/₁₆ x 22⁷/₁₆ in.

CONTROLS	
Control Type	Electronic
Position	Top
MAIN FEATURES	
Loading Capacity (Place Settings)	16
Tub Material	Stainless Steel
Interior Illumination	Top
Water Softener	Yes (DWT81800SSWS only)
DMFS Overflow Protection	Overflow Safety
5 Level Wash with 3 rd Spray Arm	3
Delay Timer	1/2 – 24 hours
Drying System	Active Ventilation
Brushless DC™ Motor	Yes
Turbidity Sensor	Yes
Silent Operation	45 dBA
All-in-1 Tablet Function	Yes
Half Load Function	Yes
Sanitize Function	Yes
SuperGloss Function	Yes
RapidClean Function	Yes
PowerWash Function with Extra Spray Arm	Yes
Interior High Loop with Air Gap	Yes
PROGRAMS	
Number of Programs	8
Pots and Pans+ (167°F)	Yes
Auto Program (131 – 149°F)	Yes
MixWash+ (131 – 149°F)	Yes
Regular Wash (142 – 145°F)	Yes
Daily Wash	Yes
GlassCare	Yes
Quick Wash (131°F)	Yes
Rinse & Hold	Yes
DISPLAY	
Rinse Aid Indicator	Yes
Salt Indicator Display	Yes (DWT81800SSWS only)
LED Spot	Yes
RACK SYSTEM	
SmartFold Lower Rack Folding Tines	4
Lower Rack Handle	Stainless Steel
Cutlery Basket	Sliding
Upper Rack (Inset Shelves)	2
SmartFold Upper Rack Folding Tines	3
FlexiRack Adjustable Upper Rack	3 Positions, Adjustable When Loaded
FlexiDrawer Removable 3 rd Rack	Standard, Full-size
Detergent Dispenser Type	Sliding Lid (Vertical)
DIMENSIONS (DWT81800SS)	
H x W x D	33 ⁷ / ₈ x 23 ⁹ / ₁₆ x 22 ⁷ / ₁₆ in. (86.1 x 59.8 x 57 cm)
Product Weight	96.1 lb. (43.6 kg)
Packed H x W x D	35 x 25 ³ / ₈ x 26 in. (88.9 x 64.4 x 66.1 cm)
Packed Weight	102.7 lb. (46.6 kg)
ENVIRONMENTAL STANDARDS	
ENERGY STAR® Qualified	Yes — Most Energy Efficient 2018
Energy Consumption	225 kWh / year
Water Consumption	2.4–4.7 gal. / cycle (2.91–6.07 gal./cycle DWT81800SSWS only)

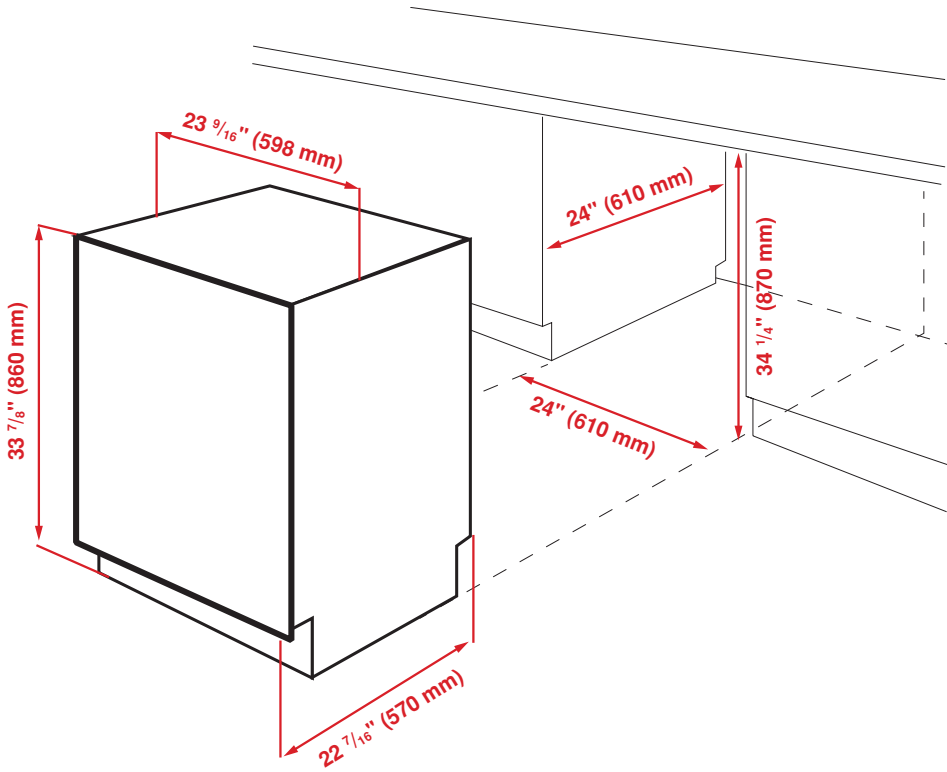

Panel Ready Requirements:

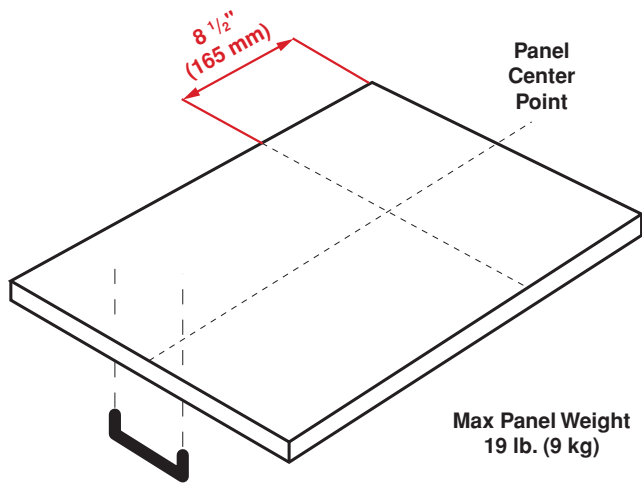

DIMENSIONS (DWT81800SS)	
H x W x D	33 7/8 x 23 9/16 x 22 7/16 in. (86.1 x 59.8 x 57 cm)
Product Weight	96.12 lb. (43.6 kg)
Packed H x W x D	35 x 25 3/8 x 26 in. (88.9 x 64.4 x 66.1 cm)
Packed Weight	102.73 lb. (46.6 kg)

DIMENSIONS (DWT81800SSIH)	
H x W x D	33 7/8 x 23 9/16 x 22 7/16 in. (86.1 x 59.8 x 57 cm)
Product Weight	96.12 lb. (43.6 kg)
Packed H x W x D	35 x 25 3/8 x 26 in. (88.9 x 64.4 x 66.1 cm)
Packed Weight	102.73 lb. (46.6 kg)

DIMENSIONS (DWT81800FBI)	
H x W x D	33 7/8 x 23 9/16 x 21 2/2 in. (86.1 x 59.8 x 55 cm)
Product Weight	91.93 lb. (41.7 kg)
Packed H x W x D	35 x 25 3/8 x 26 in. (88.9 x 64.4 x 66.1 cm)
Packed Weight	98.54 lb. (44.7 kg)

DIMENSIONS (DWT81800SSWS)	
H x W x D	33 7/8 x 23 9/16 x 22 7/16 in. (86.1 x 59.8 x 57 cm)
Product Weight	94.79 lb. (43 kg)
Packed H x W x D	35 x 25 3/8 x 26 in. (88.9 x 64.4 x 66.1 cm)
Packed Weight	101.41 lb. (46 kg)

NOTE TO THE INSTALLER: All height, width, and depth dimensions are shown in inches (as well as metric). Beko US Inc. reserves the absolute and unrestricted right to change product materials and specifications, at any time, without notice. Please visit our website at www.BlombergAppliances.com or call 888.352.2356 to verify the latest specifications with final dimensional data and other details prior to installation and making a cutout. Applicable product limited warranty information may be found in accompanying product materials, or you may contact your account manager for further details. Proper installation is the responsibility of the installer. Product failure due to improper installation is not covered under the Limited Warranty.

IN HARMONY WITH NATURE, YOUR LIFE, AND YOU.