

# Duel Fuel Range

User manual

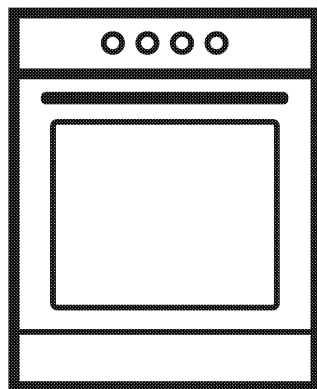

## **IMPORTANT**

**Installer** should leave these instructions with appliance.

**Consumer** should read these instructions before using the appliance and should retain them for future reference.

BDFP34550SS

# IMPORTANT SAFETY INSTRUCTIONS

## READ AND SAVE THESE INSTRUCTIONS



**WARNING:** If the information in this manual is not followed exactly, a fire or explosion may result causing property damage, personal injury or death.

— Do not store or use gasoline or other flammable vapors and liquids in the vicinity of this or any other appliance.

### — WHAT TO DO IF YOU SMELL GAS

- Do not try to light any appliance.
- Do not touch any electrical switch.
- Do not use any phone in your building.
- Immediately call your gas supplier from a neighbor's phone. Follow the gas supplier's instructions.
- If you cannot reach your gas supplier, call the fire department.

— Installation and service must be performed by a qualified installer, service agency or the gas supplier.

**TO PREVENT TIPPING:** If the information in this manual is not followed exactly, a fire or explosion may result causing property damage, personal injury or death.



## WARNING:

- ALL RANGES CAN TIP
- INJURY TO PERSONS COULD RESULT
- INSTALL ANTI-TIP DEVICES PACKED WITH RANGE
- SEE INSTALLATION INSTRUCTIONS



## WARNING:

- **DO NOT OPERATE THE RANGE WITHOUT ANTI-TIP DEVICE IN PLACE AND ENGAGED**

"After installation cautiously grip the rear of the range to ensure the anti-tip bracket is engaging the rear foot of range."

Check for proper installation and use of the anti-tip bracket. Carefully tip the range forward pulling from the back to ensure that the anti-tip bracket engages the range leg and prevents tip-over. Range should not move more than 1" (25 mm).



## IMPORTANT:

This appliance is intended for normal household use only. It is not approved for outdoor or other non-household uses (including sea or air-going vessels). See the Statement of Limited Warranty. If you have any questions, contact the manufacturer.

Do not repair or replace any part of the appliance unless specifically recommended in this manual. Refer all servicing to a factory authorized service center.

## Explanation of symbols

Throughout this User Manual the following symbols are used:



Important information or useful hints about usage.



Warning for hazardous situations with regard to life and property.



Warning for electric shock.



Warning for risk of fire.



Warning for hot surfaces.

**DANGER** indicates a hazardous situation which, if not avoided, will result in death or serious injury.

**WARNING** indicates a hazardous situation which, if not avoided, could result in death or serious injury.

**CAUTION** indicates a hazardous situation which, if not avoided, could result in minor or moderate injury.

**NOTICE** is used to address practices not related to physical injury.

Dear Customer,

Your product has been manufactured in modern facilities and has passed strict quality control procedures.

To obtain the best performance, we request that you read through this user manual carefully, especially the safety instructions, before using your product and that you keep it for future reference. If this product is given to another consumer, please give them this manual for their reference.



**IMPORTANT:**

Save these instructions for the local electrical inspectors use.



**IMPORTANT:**

This product can only be used in a room which incorporates a properly adjusted and functioning Carbon Monoxide sensor. Make sure the Carbon Monoxide sensor works properly and is maintained done frequently. Carbon Monoxide sensor should be installed maximum 6.5 feet away from the product.

**The instructions will help you to operate the appliance properly and safely.**

- Upon delivery, please check that the appliance is not damaged. If you note any transport damage, please contact the shipping company or company where you purchased the appliance immediately and do not connect and operate the appliance!
- When you pass on the appliance to another person, please provide all documents including original sales receipt which should show the date of purchasing. Warranty is not valid if the product is sold second hand.
- If you should decide not to use this appliance any longer (or decide to substitute an older model), before disposing of it, it is recommended that it be made inoperative in an appropriate manner in accordance with health and environmental protection regulations, ensuring in particular that all potentially hazardous parts be made harmless, especially in relation to children who could play with old appliances. Remove the door and the storage drawer before disposal to prevent entrapment.

## TABLE OF CONTENTS

### **1 Safety Instructions - Read before use**

**7**

Basic safety instructions .....	7
Safety for children .....	13
Safety when working with electricity .....	13
Safety when working with gas .....	14
Intended use .....	15
Disposal .....	16
Packaging material .....	16
Future transportation .....	16

### **2 Installation**

**17**

Installation and connection .....	17
Connection to the main supply .....	25

### **3 Preparation**

**29**

Tips for saving energy .....	29
Initial use .....	29
First cleaning of the appliance .....	29
Initial heating .....	29

### **4 How to use the hob**

**30**

General information about cooking .....	30
Using the hobs .....	30

### **5 How to operate the oven**

**32**

General information on baking, roasting and broiling .....	32
How to use the electric oven .....	33
Cooking times table .....	35
How to operate the broil .....	36

### **6 Maintenance and care**

**37**

General information .....	37
Cleaning the burner/plate .....	37
Cleaning the control panel .....	37
Cleaning the oven .....	37
Removing the oven door .....	39
Replacing the oven lamp .....	40

### **7 General information**

**41**

Overview .....	41
Technical specifications .....	42
Package contents .....	43
Injector table .....	45

### **8 Troubleshooting**

**46**

### **9 Removing the Package**



**47**

### **10 WARRANTY STATEMENT FOR BLOMBERG ELECTRIC AND GAS RANGES**









**49**

## **1 Safety Instructions - Read before use**

### **Basic safety instructions**

- This appliance is not intended for use by persons (including children) with reduced physical, sensory or mental capabilities, or lack of experience and knowledge, unless they have been given supervision or instruction concerning use of appliance by a person responsible for their safety.
- Children should be supervised to ensure that they do not play with the appliance.
- Be sure your range is installed and grounded properly by a qualified installer or service technician.
- Never use when judgment or coordination is impaired by the use of alcohol and/or drugs
- If the supply cord damaged, it must be replaced by a special cord or assembly available from the manufacturer or its service agent or similarly qualified persons.
-  **WARNING:** Never use your appliance for warming or heating the room.
- Do not operate the appliance if it is defective or shows any visible damage.
- Do not repair or replace any part of the appliance unless specifically recommended in the manual. All other servicing should be referred to a qualified technician.
- Do not carry out any repairs or modifications on the appliance. However, you may remedy some malfunctions; see Troubleshooting.
- Only authorized replacement parts may be used in performing service on the range. Replacement parts are available from factory authorized parts distributors. Contact the nearest parts distributor in your area.
- Never modify or alter the construction of the range including by removing leveling legs, panels, wire covers, anti-tip brackets, or screws, or any other part of the appliance.
- Be careful when using alcoholic drinks in your dishes. Alcohol evaporates in high temperatures and may cause fire since it will catch fire when it gets in contact with hot surfaces.
-  **WARNING:** Utensil handles should be turned inward and not extend over adjacent surface units - to reduce the risk of

burns, ignition of flammable materials, and spillage due to unintentional contact with the utensil, the handle of a utensil should be positioned so that it is turned inward, and does not extend over adjacent surface units.

-  **CAUTION:** Do not use aluminum foil to line drip pans or anywhere in the oven, except as described in this manual. Foil can trap heat or melt, resulting in damage to the product and a shock or fire hazard.
-  **CAUTION:** Do not use harsh abrasive cleaners or sharp metal scrapers to clean the oven door glass since they can scratch the surface, which may result in shattering of the glass.
-  **WARNING:** This appliance can be used by children aged from 8 years and above and persons with reduced physical, sensory or mental capabilities or lack of experience and knowledge if they have been given supervision or instruction concerning use of the appliance in a safe way and understand the hazards involved.
- Children shall not play with the appliance. Cleaning and user maintenance shall not be made by children without supervision.
-  **WARNING:** The appliance and its accessible parts become hot during use. Care should be taken to avoid touching heating elements. Children less than 8 years of age shall be kept away unless continuously supervised.
-  **WARNING:** Appliance must be placed directly on the floor. It must not be placed onto a base or a pedestal.
-  **WARNING:** Rear surface of the oven gets hot when it is in use. Make sure that the electrical connection does not contact the rear surface; otherwise, connections can get damaged.
-  **WARNING:** Only use the connection cable specified in the "Technical specifications". If the supply cord damaged, it must be replaced by a special cord or assembly available from the manufacturer or its service agent or similarly qualified persons in order to avoid a hazard.
- Your body accidentally can turn the knobs, please make sure that your body do not touch to knobs not for use.
-  **WARNING:** Food Poisoning Hazard: Do not let food sit in oven for more than 1 hour before or after cooking. Doing so



can result in food poisoning or sickness.

- **⚠ WARNING:** To avoid permanent damage to the oven bottom finish do not line the oven bottom with any type of foil or liner.
- **⚠ WARNING:** Never cover the top of burner grates with any kind of cover. Use only cooking utensils with recommended diameters. Make sure ventilation and oven fume outlets shown below are not closed. Otherwise fire hazard and carbon monoxide poisoning can occur.

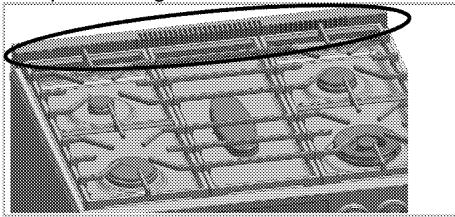



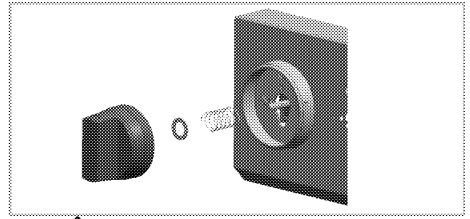

- Do not heat closed food containers and glass jars. Pressure that may build-up in the jar can cause it to burst.
- **⚠ WARNING:** ( If your product has no illuminated knobs ) : Do not remove knobs. Service authorized person should do it. There is a steel spring and steel ring inside the knob. Do not remove them. Otherwise, can be dangerous for the health issue and functionality.

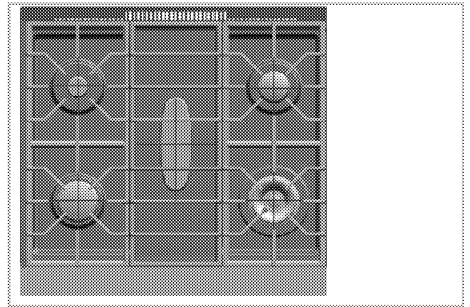









- **⚠ WARNING:** Make sure that top burner grates are always centered on top of burners, as seen in the figure below. Misplacing of top burner grates may cause carbon monoxide poisoning and death. Always control top burner grates position before use.





- **⚠ WARNING:** Keep appliance area clear and free from combustible materials, gasoline, and other flammable vapors.
- Ensure that no flammable materials are adjacent to the appliance as the sides become hot during use.
- **⚠ WARNING:** Storage in or on Appliance- Flammable materials should not be stored in an oven or near surface units.





-  **WARNING:** Do not use water on grease fires. Never pick up a flaming pan. Turn the controls off. Smother a flaming pan on a surface unit by covering the pan completely with a well-fitting lid or a fire blanket, cookie sheet or flat tray. Use a multi-purpose dry chemical or foam-type fire extinguisher.  
If there is a fire in the oven during baking, smother the fire by closing the oven door and turning the oven off or by using a multi-purpose dry chemical or foam-type fire extinguisher.
- Do not leave empty pots or pans on plates that are switched on. They might get damaged.
- Since it may be hot, do not leave plastic or aluminum dishes on the surface of appliance. These kind of dishes should not be used to keep food either.
- The manufacturer declines all liability for injury to persons or damage to property caused by incorrect or improper use of the appliance.
-  **CAUTION:** Always use only dry potholders or heat-resistant gloves when inserting or removing the dishes into/from your oven. Do not let potholder touch hot heating elements. Do not use a towel or other bulky cloth.
-  **WARNING:** NEVER cover any slots, holes or passages in the oven bottom or cover an entire rack with materials such as aluminum foil. Doing so blocks air flow through the oven and may cause carbon monoxide poisoning. Aluminum foil linings may also trap heat, causing a fire hazard.
- Do not use the oven with front door glass removed or broken.
-  **WARNING:** Rear surface of the oven gets hot when it is in use. Electric connection should not touch the rear surface, otherwise the main cable may get damaged. Do not trap the main cable between the hot oven door and frame. Do not route the main cable over the hot cooking section. Otherwise, cable insulation may melt and cause fire as a result of short circuit.
- Never wear loose-fitting or hanging garments while using the appliance. Be careful when reaching for items stored in cabinets over the oven. Flammable material could be ignited if brought in contact with hot surfaces or heating elements and may cause severe burns.
- Flame in the oven can be smothered completely by closing the oven door and turning the oven

- off or by using a multi-purpose dry chemical or foam-type fire extinguisher.
- Place the oven rack in the desired position while the oven is cool. If racks must be handled when hot, do not let pot holder contact the heating elements.
- Do not use aluminum foil to line surface unit drip bowls or oven bottoms or oven bottoms, except as suggested in the manual. Improper installation of these liners may result in a risk of electric shock, and/or fire.
-  **WARNING:** Do not use the oven to dry newspapers. If overheated, they can catch on fire.
-  **WARNING:** After broiling, always take any broiler pan out of the oven and clean it. Leftover grease in a broiler pan can catch fire next time you use the pan.
- Check that all controls on the appliance are switched off after use.
-  **WARNING:** Never leave surface units unattended at high heat settings. Boil over causes smoking and greasy spill overs that may ignite.
-  **WARNING:** Accessible parts may become hot during use. Young children should be kept away.
-  **WARNING:** During self-cleaning, surfaces may become hotter than with standard use. Keep children away.
-  **CAUTION:** Use care when opening door- let hot air or steam escape before removing or replacing food.
-  **CAUTION:** Placement of oven racks -always place oven racks in desired location while oven is cool. If rack must be moved while oven is hot, do not let potholder contact hot heating element in oven.
-  **CAUTION:** Do not store or use flammable materials in an oven or near the cook top, including paper, plastic, pot holders, linens, wall coverings, curtains, drapes and gasoline or other flammable vapors and liquids.
-  **WARNING:** "Do not touch heating elements or interior surfaces of oven - Heating elements may be hot even though they are dark in color. Interior surfaces of an oven become hot enough to cause burns. During and after use, do not touch, or let clothing or other flammable materials contact heating elements or interior surfaces of oven until they have

had sufficient time to cool. Other surfaces of the appliance may become hot enough to cause burns - among these surfaces are oven vent openings and surfaces near these openings, interior surfaces of the oven cavity, oven doors, and window."

- ◆ Do not heat unopened food containers. Pressure could build up and the container could burst, causing an injury.
- ◆ Do not use the oven for a storage area. Items stored in an oven can ignite.
- ◆  **WARNING:** Keep the oven free from grease buildup. Grease in the oven may ignite.
- ◆  **WARNING:** Do not leave paper products, cooking utensils or food in the oven when not in use.
- ◆ Do not place baking trays, dishes or aluminum foil directly onto the bottom of the oven. The heat accumulation might damage the bottom of the oven.
- ◆  **WARNING:** Keep all ventilation slots clear of obstructions.
- ◆ Rear surface of the oven gets hot when it is in use. Electric connection should not touch the rear surface, otherwise the main cable may get damaged.

Do not trap the main cable between the hot oven door and frame. Do not route the main cable over the hot cooking section. Otherwise, cable insulation may melt and cause fire as a result of short circuit.

- ◆  **WARNING:** Use this appliance for its intended purpose as described in this owner's manual.
- ◆  **CAUTION:** Always use heat-resistant gloves when putting or removing the dishes into/from your oven.
- ◆  **WARNING:** Heating element may be hot even though they are dark in color. Interior surfaces of an oven become hot enough to cause burns. During and after use, do not touch or let clothing or other flammable materials contact heating elements or interior surfaces of oven until they have had sufficient time to cool. Other surfaces of the appliance may become hot enough to cause burns- among these surfaces are (identification of surfaces — for example, oven vent openings and surfaces near these openings, oven door, and windows of oven doors).
- ◆  **WARNING:** Avoid scratching or impacting glass doors, cook

tops or control panels. Doing so may lead to glass breakage. Do not cook on a product with broken glass. Shock, fire or cuts may occur.

- **i** **IMPORTANT:** Call the authorized service for installation of the appliance to be used. After this procedure, guarantee period will be started.

### **Safety for children**

- **WARNING:** Stepping, leaning or sitting on the door or drawers of this range can result in serious injuries and also cause damage to the range. Do not allow children to climb or play around the range. The weight of a child on an open door may cause the range to tip, resulting in serious burns or other injury.
- **⚠️ WARNING:** Accessible parts may be hot when the broil is in use. Young children should be kept away.
- Surface units may be hot even though they are dark in color. Areas near surface units may become hot enough to cause burns. During and after use, do not touch or let clothing or other flammable materials contact surface units until they have had sufficient time to cool. Among these areas are (identification of

areas) for example, the cook-top and surfaces facing the cook-top.

- **⚠️ WARNING:** Do not store items of interest to children in the cabinets above the range or on back guard of a range. Children climbing on the range to reach items could be seriously injured.
- The packaging materials will be dangerous for children. Keep the packaging materials away from children. Please dispose of all parts of the packaging according to environmental standards.

### **Safety when working with electricity**

- **⚠️ WARNING:** Before installing, turn power OFF at the service panel. Lock service panel to prevent power from being turned ON accidentally.
- **⚠️ WARNING:** Personal injury or death from electrical shock may occur if the range is not installed by a qualified installer or electrician.
- Any additions, changes or conversions required in order for this appliance to satisfactorily meet the application needs must be made by a qualified technician.
- In case of any damage, switch off the appliance and disconnect it from the main supply by re-

moving the fuse or switching off the circuit breaker.

- Ensure that the fuse rating is correct.
- Do not operate the appliance barefooted.
- Never touch the appliance with wet hands or feet.

### **Safety when working with gas**

-  **WARNING:** To reduce the risk of personal injury in the event of a grease fire, observe the following:
  - Smother flames with a close-fitting lid, cookie sheet, or metal tray, then turn off the burner. Exercise caution to prevent burns. If the flames do not go out immediately, evacuate and call the fire department.
  - Never pick up a flaming pan—You may be burned.
  - Do not use water, including wet rags
  - Or towels—a violent steam explosion will result.
  - Make certain that gas shutoff valve and all burner controls are in the OFF position before beginning.

### **Use an extinguisher only if:**

- 1) You know you have a CLASS ABC extinguisher and you already know how to operate it.
- 2) The fire is small and contained in the area where it started.

3) The fire department is being called.



4) The fire does not obstruct your escape route.

- Any works on gas equipment and systems may only be carried out by authorized qualified persons.
- "Prior to the installation, ensure that the local distribution conditions (nature of the gas and gas pressure) and the adjustment of the appliance are compatible."
- "This appliance is not connected to a combustion products evacuation device. It shall be installed and connected in accordance with current installation regulations. Particular attention shall be given to the relevant requirements regarding ventilation;" See Before installation.
-  **CAUTION:** "The use of gas cooking appliance results in the production of heat and moisture in the room in which it is installed. Ensure that the kitchen is well ventilated: keep natural ventilation holes open or install a mechanical ventilation device (mechanical extractor hood). Prolonged intensive use of the appliance may call for additional ventilation, for example increasing the level of the mechanical ventilation where present."

- Gas appliances and systems must be regularly checked for proper functioning. Please arrange for annual maintenance.
- Clean the gas burners regularly. The flames should be blue and burn evenly.
- Good combustion is required in gas appliances. In case of incomplete combustion, carbon monoxide (CO) might develop. Carbon monoxide is a colorless, odorless and very toxic gas, which has a lethal effect even in very small doses.
- Request information about gas emergency telephone numbers and safety measures in case of gas smell from you local gas provider.
- The appliance and its individual shut-off valve must be disconnected from the gas supply piping system during any pressure testing of that system at test pressures in excess of 1/2 psi (3.5 kPa).
- The appliance must be isolated from the gas supply piping system by closing its individual manual shutoff valve during any pressure testing of the gas supply piping system at test pressures equal to or less than 1/2 psi (3.5 kPa).

- Hob burners will not automatically re-ignite in the event of power failure and unignited gas will still be expelled from the burners. Switch off burners immediately whenever a power failure occurs.

### **Intended use**

-  **WARNING:** Use this appliance only for its intended use as described in this manual. NEVER use this appliance as a space heater to heat or warm a room. Doing so may result in carbon monoxide poisoning and overheating the appliance. Never use the appliance for storage.
- This appliance should not be used for warming the plates under the broil, hanging towels and dish cloths on the handles, for drying and the space heating purposes.
- All openings in the wall behind the appliance and in the floor under the appliance shall be sealed.
- This appliance is not intended to use at mobile homes, recreational vehicles.
-  **WARNING:** Do not obstruct the flow of ventilation air.
- The manufacturer shall not be held liable for any damage caused by improper use or handling errors.

- The appliance can be used for defrosting, baking, roasting and broiling food.

## Disposal

### Packaging material



#### **DANGER:**

Risk of suffocation by the packaging materials!

Packing elements (i.e. plastic bags, polystyrene foam, nails, packing straps, etc.) should not be left around within easy reach of children, as these may cause serious injuries.

The packaging material and transport locks are made from materials that are not harmful to the environment. Please dispose of all parts of the packaging according to environmental standards. This is beneficial to the environment.



#### **CAUTION:**

If product will be given to someone for personal use or given to someone for second hand use, User manual, product labels, other related documents, mounting parts etc. should be given with product.

## Future transportation

Do not carry out cleaning or maintenance operations on the appliance without having previously disconnected it from the electric power supply.



#### **NOTICE:**

Do not place other items on the top of the appliance. The appliance must be transported upright.

Store the appliance's original box and transport the appliance in its original carton. Follow the guidance marks that are printed on the carton.



#### **IMPORTANT:**

Verify the general appearance of your equipment by identifying possible damage during the transportation.

To prevent the wire shelf and tray inside the oven from damaging the oven door, place a strip of cardboard onto the inside of the oven door that lines up with the position of the trays. Tape the oven door to the side walls.

#### **If you do not have the original carton**

Pack the appliance in bubble wrap or thick cardboard and tape it securely in order to prevent damage during transportation.



## 2 Installation

To ensure that critical air gaps are maintained under the appliance, we recommend that this appliance is mounted on a solid base and that the feet do not sink into any carpet or soft flooring.

The kitchen floor must be able to carry the weight of the appliance plus the additional weight of cookware and bake ware and food.

- If an appliance hood is to be fitted, refer to the manufacturer's instructions regarding fixing height.
- The appliance corresponds to device class 1, i.e. it may be placed with the rear and one side to kitchen walls, kitchen furniture or equipment of any size. The kitchen furniture or equipment on the other side may only be of the same size or smaller.
- Any kitchen furniture next to the appliance must be heat-resistant (212°F/100°C min.).

### Room ventilation

The air for combustion is taken from the room air and the exhaust gases are emitted directly into the room.

Good room ventilation is essential for safe operation of your appliance. If there is no window or door available for room ventilation, an extra ventilation must be installed.

Do not install this appliance in a room below ground level unless it is open to ground level on at least one side. Failure to install correctly is dangerous and could result in prosecution.

Prolonged intensive use of the appliance may call for additional ventilation, for example the opening of a window, or the use of permanent fixed mechanical ventilation system, for example, an extractor fan or cooker hood that ventilates to the outside.

Room size	Ventilation opening
smaller than 177 ft <sup>3</sup>	min. 15.5 in <sup>2</sup>
177 ft <sup>3</sup> to 353 ft <sup>3</sup>	min. 7.75 in <sup>2</sup>
greater than 353 ft <sup>3</sup>	not required
in the cellar or basement	min. 10.1 in <sup>2</sup>

Be sure your appliance is properly installed and grounded by a qualified technician in accordance with the National Fuel Gas Code ANSI Z223.- latest edition, or in Canada, CAN/CGA B149.1, and CAN/CGA B149.2, and National Electrical Code ANSI/NFPA No.70 - latest edition, or in Canada CSA Standard C22.1, Canadian Electrical Code, Part 1 and local code requirements.

### Installation and connection



#### IMPORTANT:

Do not install the appliance next to refrigerators or freezers. The heat emitted by the appliance will lead to an increased energy consumption of cooling appliances.

- For installation the appliance must be connected in accordance with all local electrical and/or gas regulations.



#### CAUTION:

Unit is heavy (approximately 150 kg (330 lbs)) and requires at least two persons or proper equipment to move. Do not move more than 3 meters without any instrument. Otherwise, you can cause injury.

- Hidden surfaces may have sharp edges. Use caution when reaching behind or under appliance.
- Do not use the oven (if equipped) for storage.



#### NOTICE

##### Material damage!

The door and/or handle must not be used for lifting or moving the appliance. The appliance must be placed directly on the floor. It must not be placed onto a base or a pedestal.

- \* To align the appliance with the worktop, adjust the feet turning right or left hand as required.





### **NOTICE: Material damage!**

Do not place other items on the top of the appliance. The appliance must be transported upright. The door and/or handle must not be used for lifting or moving the appliance. Take care not to touch the oven heating element also located at the top of the oven cavity, just behind the ridged area. It is recommended to wear gloves and long sleeves to protect hands and forearms from abrasion and potential scratches during the lifting process. It is also recommended to take off watches and jewelry and to wear work shoes during installation for foot protection. Remove the oven door for easier handling and installation.

- The appliance must be placed directly on the floor. It must not be placed onto a base or a pedestal.

### **How to move the appliance**

Movement of your appliance is most easily achieved by lifting the front as indicated in the drawing. Open the oven door sufficiently to allow a comfortable and safe grip on the underside of the oven roof avoid causing any damage to the grill element or any internal parts of the oven. Do not move by pulling on the door handle or knobs. Move the appliance a bit at a time until placed in the position required.

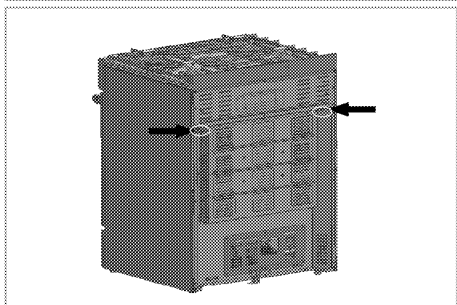
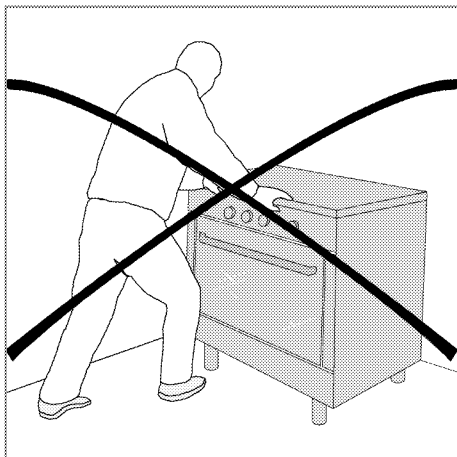
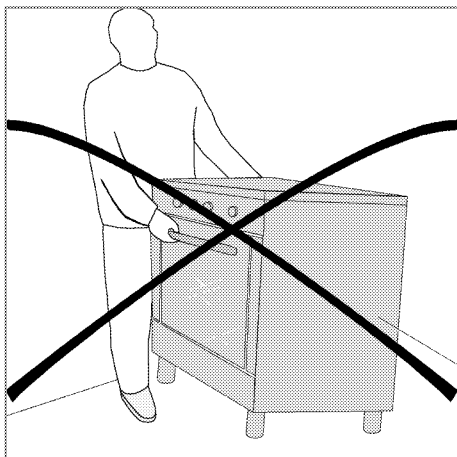
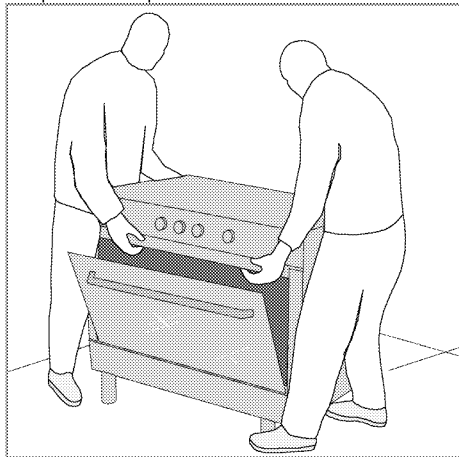

### **Clearances & Dimensions**

Dimensions that are shown in figure must be used. Given dimensions provide minimum clearance. There needs to be a 30-inch (762mm) minimum clearance between the top of the cooking surface and the bottom of unprotected

wood or metal cabinets or a 24-inch (609mm) minimum when bottom of wood or metal cabinets are protected by not less than a 1/4-inch (6mm) flame retardant millboard covered with not less than no. 29 msg sheet-steel, 0.015-inch (38mm) stainless steel, 0.024-inch (0.6mm) aluminum or 0.020-inch (0.05mm) copper.

To eliminate the risk of burns or fire by reaching over heated surface units, cabinet storage space located above the surface units should be avoided. If cabinet storage is to be provided, the risk can be reduced by installing a range hood that projects horizontally a minimum of 5 inches (127 mm) beyond the bottom of the cabinets. Verify that cabinets above the cooktop are a maximum of 13" (330 mm) deep.

This appliance is not intended for use in mobile homes, recreational vehicles.



### **Important notes to the consumer**

Keep this manual for future reference.

- As when using any range generating heat, there are certain safety precautions you should follow. These are listed in the front of this manual. Read and follow carefully.
- Be sure your range is installed and grounded properly by a qualified installer or service technician.
- To eliminate the need to reach over the cook top, cabinet storage space above the cook top should be avoided.



### **Important notes to the installer**

Read manual before installing the cooker.

Observe all governing codes and ordinances.

Be sure to leave these instructions with the consumer.

Be sure your range is installed and grounded properly by a qualified installer or service technician.



### **IMPORTANT:**

Before installing the range in an area covered with linoleum or any other synthetic floor covering, make sure the floor covering can withstand heat at least 90°F (32.2°C) above room temperature without shrinking, warping or discoloring.

Do not install the range over carpeting unless you place an insulating pad or sheet of 1/4 inch (0.64cm) thick plywood between the unit and carpeting.



### **WARNING:**

All ranges can tip and injury to persons could result.

- Anti-Tip stability devices are fixed on wooden plate. During the removing packaging materials, the Anti-Tip stability devices should be unscrewed from wooden plate and should not be thrown away.
- A risk of tip-over may exist if the appliance is not installed in accordance with these instructions.
- If the range is pulled away from the wall for cleaning, service or any other reason, ensure that the Anti-Tip Device is properly re-engaged when the range is pushed back against the wall. In the event of abnormal usage (such as a person standing, sitting or leaning on an open door), failure to take this precaution can result in tipping of the range. Personal injury might result from spilled hot liquids or from the range itself.

### **Anti-Tip stability device installation instructions**

1. Fix the bracket 1 to the floor with 4 screws (5) in accordance with the dimensions and direction indicated in Picture 1.
2. Measure dimension A of the product indicated in Picture 2 according to the height of counter. Decide the hole on bracket 1 to which the bracket 2 will be secured. Complete the installation by tightening parts 3 and 4.
3. Position the appliance on its place after completing the installation.
4. Check whether the appliance is locked with bracket by gently lifting it up from rear side to front side.

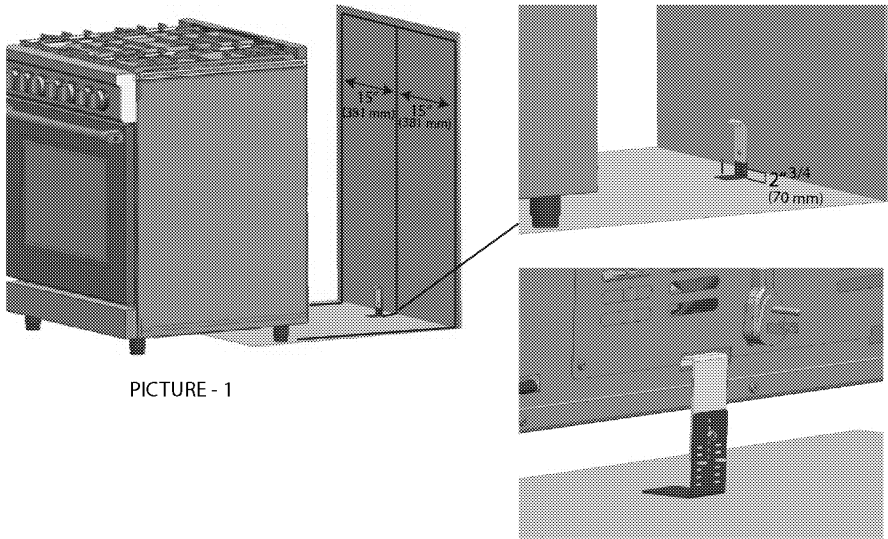

PICTURE - 1

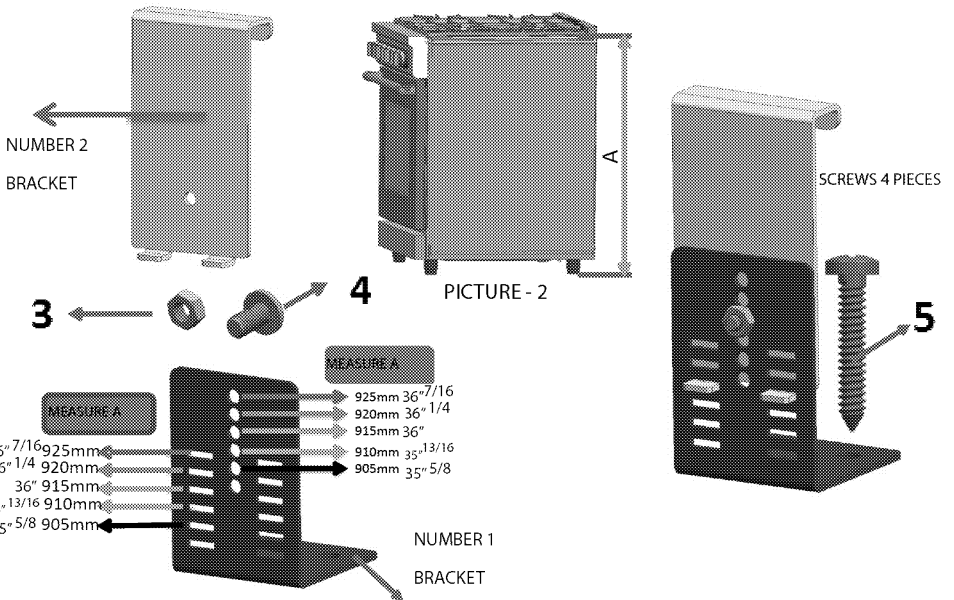

**WARNING: Tip Over Hazard**

A child or adult can tip the range and be killed. Connect anti-tip bracket to anti-tip hole at the back of the range. Reconnect the anti-tip bracket, if the range is moved. Failure to follow these instructions can result in death or serious burns to children and adults.

**WARNING: Electrical shock hazard!**

- Use extreme caution when drilling holes into the wall or floor. There may be concealed electrical wires located behind the wall or under the floor.
- Identify the electrical circuits that could be affected by the installation of the Anti Tip Device, then turn off power to these circuits.

**Failure to follow these instructions may result in electrical shock or other personal injury.**

**Connection to the gas supply**

This appliance has been tested in accordance with the following standards:

- ANS Z21.1b-2012 Household Cooking Appliances
- It is the responsibility of the owner and the installer to determine if additional requirements, such as local codes and/or standards, apply to specific installations. In the absence of local codes, the installation must conform with the National Fuel Code, ANSI Z223.1/NFPA54.

**For Massachusetts Installations:**

1. Installation must be performed by a qualified or licensed contractor, plumber or gas fitter qualified or licensed by the state, province or region where this appliance is being installed.
2. Shut-off valve must be a "T" handle gas cock.
3. Flexible gas connector must not be longer than 36 inches.

installer -show the owner where the gas shut-off valve is located.

**High Altitude Installation note:**

This cooker is ETL certified for safe operation up to an altitude of 2,000 ft. without any modifications. For higher altitudes, please contact with Service.

**Connect to the gas supply****WARNING:**

This product can be converted to LP Gas. Gas conversion must always be performed by Authorized Service Agents.

The gas connection is located below the back panel of the range. It is accessible back of the range.

Shut off main gas supply valve before disconnecting the old range and leave it off until the new hook-up has been completed.

The cooker can be installed using rigid pipe or a CSA, cCSAus, UL International-certified flexible metal appliance connector. If using a flexible connector, always use a new connector.

Apply pipe joint compound or tape appropriate for use with Natural gas around all male pipe threads to prevent leaks.

If not already present, install gas shut off valve in an easily accessible location. Make sure all users know where and how to shut off the gas supply to the range.

Gas supply pressure for checking the regulator setting is 6" WC.

**NOTICE:**

The installer should inform the consumer of the location of the gas shut-off valve. Flexible Connector Method

1. Install male 1/2" flare adaptor at the 1/2" NPT internal thread of the range inlet. Use a backup wrench on the elbow fitting to avoid damage.
2. Install male 1/2" or 3/4" flare union adapter on the NPT internal thread of the manual shut-off valve.
3. Connect flexible metal appliance connector.
4. Make sure circuit breaker is off and then plug range cord in to electrical outlet
5. Push range back into position insuring that range leg slides under the anti-tip bracket. The range will sit 3/4" away from the wall when properly installed.

**NOTICE:**

Be careful not to crimp flexible connector!

6. Carefully tip range forward to insure that anti-tip bracket engages and prevents tip-over.

**Rigid Pipe Method** The configuration of the rigid pipe connection will vary depending on the location of the gas pipe stub. Refer to Figure below for details.

1. Make sure circuit breaker is off and then plug range cord in to electrical outlet

2. Push range back into position insuring that range leg slides under the anti-tip bracket. The range will sit 3/4" away from the wall when properly installed.

3. Carefully tip range forward to insure that anti-tip bracket engages and prevents tip-over.

4. Connect pipe to range at union. Access the connection through the access panel behind the warming drawer.

Proceed to "Test for Gas Leaks"

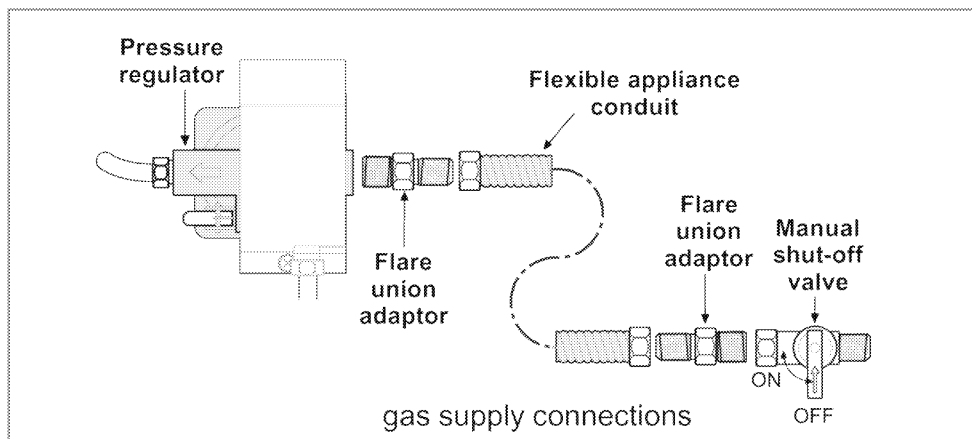

## Test for Gas Leaks

Leak testing shall be conducted by the installer according to the instructions given in this section.

**Turn on Gas.** Apply a non-corrosive leak detection fluid to all joints and fittings in the gas connection between the shut-off valve and the range. Include gas fittings and joints in the range if connections may have been disturbed during installation. **Bubbles appearing around fittings and connections indicate a leak.**

If a leak appears, turn off supply line gas shut-off valve and tighten connections. Re-test for leaks by turning on the supply line gas shut-off valve. When leak check is complete (no bubbles appear), test is complete. Wipe off all detection fluid residue.



### WARNING:

Never check for leaks with a flame. Do not continue to the next step until all leaks are eliminated.



### WARNING:

Before you plug in an electrical cord, be sure all controls are in the OFF position.

## Test burner function

### 1. Turn on Power at Breaker

Verify that wiring in house is correctly installed. If not call Service.

### 2. Test Range top Burners

**Test Burner Ignition.** Select a range top burner knob. Push down and turn to the flame symbol. The igniter/spark module will produce a clicking sound. Once the air has been purged from the supply lines, the burner should light within four (4) seconds.

**Test Flame: High Setting.** Turn burner on to HI. See for appropriate flame characteristics. If any of the burners continue to burn mostly or completely yellow, call Service.

**Test Flame: Low Setting.** Turn burner on to L.O. Verify that the flame completely surrounds the burner. There should be a flame at each burner port and there should be no air gap between the flame and the burner. If any of the burners do not carry over, call Service.

Test the ignition and flame of each range top burner as described above.

## When flame is properly adjusted

There should be a flame at each range top burner port.

There should be no air gap between the flame and the burner port.

### 3. Test Oven Burners

Open the oven door. Remove the two front thumb screws of oven bottom cover, slide cover forward and out. Remove the reflector cover forward and out.

**Test Bake Burner Ignition.** Set the oven to bake at 350° F. After 30-75 seconds, the burner will ignite. The burner will stay lit until the 350° F is reached and then shut off. From this point forward, the burner will cycle on and off to maintain the temperature.

**Test Bake Burner Flame.** While the burner is lit, inspect the flame. See below flame figures for proper flame characteristics. If the flame burns completely or mostly yellow, adjust the bake burner air shutter. See below flame figures (next page) for details.

**Test Broil Burner Ignition.** Set cooking mode to Hi Broil. The burner will ignite after 30-75 seconds.

**Test Broil Burner Flame.** While the burner is lit, inspect the flame. See below flame figures for proper flame characteristics. If the flame burns completely or mostly yellow, adjust the broil burner air shutter. See below flame figures for details.

**Replace the reflector cover and oven bottom cover.** Fix the cover with two rear thumb screws.

## Flame Characteristics

### Yellow Flames:

Further adjustment is required



### Soft Blue Flames:

Normal for Natural Gas.



If the flame is completely or mostly yellow, verify that the regulator is set for the correct fuel. After adjustment, retest.

Some yellow streaking is normal during the initial start-up. Allow unit to operate 4-5 minutes and re-evaluate before making adjustments.



### Call Service if;

1. Any of the burners do not light.
2. The broil burner or bake burner flame goes out before reaches 350° F.
3. Any of the burners continue to burn yellow-low.



#### NOTICE:

If the temperature of the oven increases unintended, turn off the oven and call the authorized service agent or technician with license to have oven repaired.

The California Safe Drinking Water and Toxic Enforcement Act requires the Governor of California to publish a list of substances known to the State of California to cause cancer, birth defects, or other reproductive harm, and requires businesses to warn of potential exposure to such substances.



#### IMPORTANT:

This product contains a chemical known to the State of California to cause cancer, birth defects, or other reproductive harm.

This appliance can cause low-level exposure to some of the substances listed, including benzene, formaldehyde, carbon monoxide, and toluene. The fiberglass insulation in self-clean ovens gives off a very small amount of carbon monoxide, benzene, formaldehyde and toluene during the cleaning cycle. Exposure can be minimized by venting with an open window or using ventilation fan or hood.

### Connection to the main supply



#### IMPORTANT:

Electrical installation should comply with national and local codes.



#### IMPORTANT:

This appliance must be grounded!



#### WARNING

Avoid fire hazard or electrical shock. Do not use an adapter plug, an extension cord, or remove grounding prong from electrical power cord, have a qualified electrician install an outlet near the appliance. Failure to follow this warning can cause serious injury, fire or death.



#### WARNING

Risk of Electric Shock or Fire. Grounding through the neutral conductor is prohibited for new branch circuit installations (1996 NEC), mobile homes, and recreational vehicles, or in an area where local codes prohibit grounding through the neutral conductor.

Before starting any work the electrical installation, the electrical power to the range must be shut off while line connections are being made.

Failure to follow these instructions can result in death, fire, or electrical shock.

#### Provide Electrical connection

Install the junction box under the cabinet and run 120/240 or 120/208 Volt, AC wire from the main circuit panel. DO NOT connect the wire to the circuit panel at this time.

#### Electrical requirements

This appliance must be supplied with the proper voltage and frequency and connected to an individual, properly grounded branch circuit, protected by a circuit breaker or fuse. A circuit breaker or fuse is required by your appliance. The circuit breaker or fuse amperage recommended for your appliance is 40A or 50A.

#### Observe all governing codes and local ordinances

A 3 wire or 4 wire single phase 120/240 or 120/208 Volt, 60 Hz AC only electrical supply is required on a separate circuit fused on both sides of the line (red and black wires). A time-delay fuse or circuit breaker is recommended. DO NOT fuse neutral (white wire).

NOTE: Wire sizes and connections must conform with the fuse size and rating of the appliance in accordance with the American National Electrical Code ANSI/ NFPA No. 70-latest edition.



#### IMPORTANT:

This appliance must be properly grounded to avoid shock hazard!

Our company shall not held responsible for any damage caused by using the appliance without grounded receptacle.

This range must be electrically grounded in accordance with local codes, or in their absence, with the National Electrical Code ANSI/NFPA No. 70-latest edition in United States. Installation should be made by a Licensed electrician.

 **WARNING:**  
 Risk of electric shock, short circuit or fire by damage of the main power supply!  
 The main power supply lead must not be clamped, bent or trapped or come into contact with hot parts of the appliance. If the main power cable is damaged, it must be replaced by a qualified electrician.

This range may be connected by means of permanent "hard wiring" (flexible armored or nonmetallic shielded copper or aluminum cable), or by means of a power supply cord kit. Only a power supply cord kit rated at 120/ 240 volts and 40 or 50 amperes terminating in tinned leads and marked for use with ranges shall be used. If a 50 Ampere cord is used it must be marked for use with a 1 3/8 inches (35 mm) diameter opening. Cord must have either 3 or 4 conductors to match electric receptacle (Use copper or Aluminum Conductors).

 **WARNING:**  
 Risk of fire or electrical shock exists if an incorrect size appliance cord kit is used or the Installation manual or strain relief clamp are disregarded.

 **WARNING:**  
 Do not loosen the nuts which secure the factory-installed range wiring to the terminal block while connecting range. Electrical failure or loss of electrical connection may occur.

When installed where it is not permitted to ground through the neutral, a 4-conductor cord must be used or cable assembly. See manufacturer's instructions.

The main supply data must correspond to the data specified on the rating plate of the appliance. The rating plate is either seen when the door is opened.

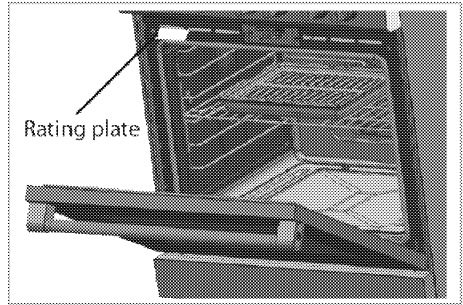

**3 & 4 -wire electrical wall receptacle types & recommended mounting orientation on wall**

Figure A illustrates 4-wire receptacle required for new branch circuit installation (1996 NEC) mobile homes, and recreational vehicles or where local codes do not allow grounding thru the neutral. Figure B illustrates 3-wire receptacle that is allowed in areas that allow grounding through neutral.

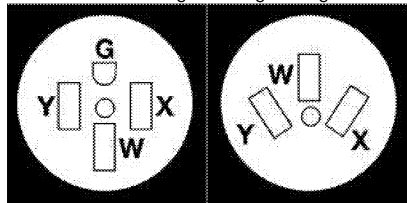

A) 4-wire wall receptacle      B) 3-wire wall receptacle (10-50R)

**Access to terminal block**

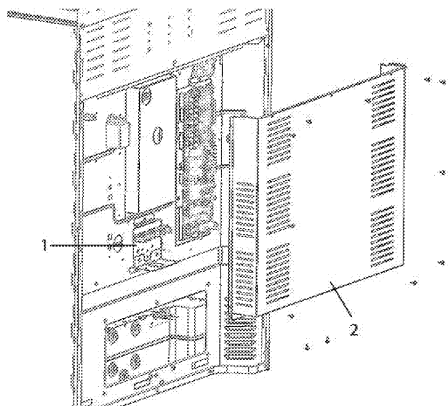

1 Terminal block  
 2 Cover

Loosen the screws on rear access cover and take off the terminal block cover.

After completing connections put terminal block cover to the original location and tighten the screws.

### Power cord connections



#### WARNING

Risk of electric shock!

Frame grounded to neutral of appliance through a link. Grounding through the neutral conductor is prohibited for new branch-circuit installations (1996 NEC); mobile homes; and recreational vehicles, or in an area where local codes prohibit grounding through the neutral conductor. For installations where grounding through the neutral conductor is prohibited:

- a- Disconnect the link from the neutral;
- b- Use grounding terminal or lead to ground unit; and
- c- Connect neutral terminal or lead to branch circuit neutral in usual manner (when the appliance is to be connected by means of a cord kit, use 4-conductor cord or conduit for this purpose) See fig.9.

- Do not use an extension cord.



#### IMPORTANT:

Do not loosen the factory installed nut connections which secure the range wiring to terminal block. Electrical failure or loss of electrical connection may occur if these 3 nuts are loosened or removed.

### Power cord

#### Train relief installation

A ground strap is installed on this range which connects the center terminal of the neutral terminal block to the range chassis. The ground strap is connected to the range by the center, lowest screw. See Figure 9. The ground strap must not be removed unless National, State or Local Codes do not permit use of a ground strap.

Note: If the ground strap is removed for any reason, a separate ground wire must be connected to the separate ground screw attached to the range chassis and to an adequate ground source.

3 & 4-wire permanent wire connections

3-wire permanent connection - follow steps in, 2 and 5 below. 4-wire permanent connection — follow all steps below.

Before wiring the range, review the suggested power source location drawings in Figure 2. If connecting to a 4-wire electrical system

1. Follow the manufacturer's Installation Instructions supplied with the strain relief clamp and install.
2. Strip insulation away from the ends of the permanent wiring for line 1, line 2 and neutral; also strip ground wire on 4-wire connections. Tighten all 3 or 4-wire leads to the terminal block. Follow wire locations shown in Figure 10.

**IMPORTANT DO NOT LOOSEN** the factory installed at connections which secure the range wiring to the terminal block. Electrical failure or loss of electrical connection may occur if these 3 nuts are loosened or removed.

Note: For 3-wire permanent connection skip steps 3 and 4 and continue with step 5.

3. Disconnect the ground strap. Remove the factory installed ground screw and plate to release the factory installed copper ground strap from frame of the range. Cut and discard the copper strap from the terminal block. KEEP the ground screw, ground plate and go to step 4.
4. Connect the green ground wire lead to the frame of the range using the ground screw and plate as shown in Figure . Be sure to install using the same hole in the frame where the ground screw was originally installed.
5. Make sure all connections are tightened securely and replace the rear access cover. See Figure .

Note: Non-terminated field wire compression connections must be set at approximately 90 in./lbs.

### 4-wire connection

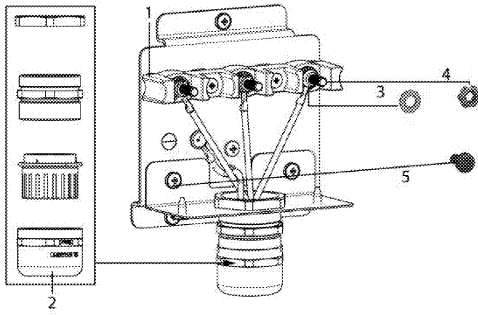

- 1 Terminal block
- 2 Power cord/conduit plate
- 3 Washer
- 4 Nut
- 5 Screw

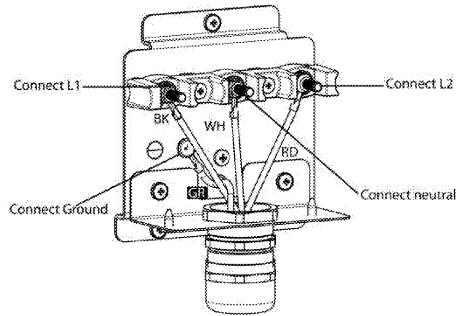

- BK Black
- WH White
- RD Red
- GR Green

### 3-wire connection

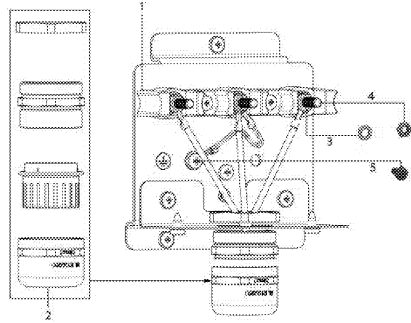

- 1 Terminal block
- 2 Power cord/conduit plate
- 3 Washer
- 4 Nut
- 5 Screw

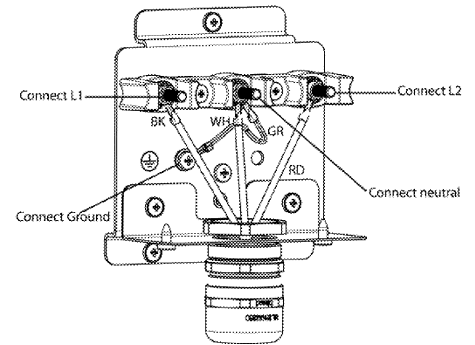

- BK Black
- WH White
- RD Red
- GR Green

## 3 Preparation

### Tips for saving energy

The following information will help you to use your appliance in an ecological way, and to save energy:

- Use dark colored or enamel coated cookware in the oven since the heat transmission will be better.
- While cooking your dishes, perform a pre-heating operation if it is advised in the user manual or cooking instructions.
- Do not open the door of the oven frequently during cooking.
- Try to cook more than one dish in the oven at the same time whenever possible. You can cook by placing two cooking vessels onto the wire shelf.
- Cook more than one dish one after another. The oven will already be hot.
- Defrost frozen dishes before cooking them.
- You can save energy by switching off your oven a few minutes before the end of the cooking time. (The oven door should not be opened).
- Use pots/pans with cover for cooking. If there is no cover, energy consumption may increase 4 times.
- Select the burner which is suitable for the bottom size of the pot to be used. Always select the correct pot size for your dishes. Larger pots require more energy.

### Initial use

#### First cleaning of the appliance

**IMPORTANT:**

When removing appliance for cleaning and/ or service; Disconnect AC power supply. Carefully remove the range by pulling outward. Range is heavy, use care in handling.



The surface might get damaged by some detergents or cleaning materials. Do not use aggressive detergents, cleaning powders/creams or any sharp objects during cleaning. Be careful to avoid steam burn. Some cleaners can produce noxious fumes if applied to a hot surface.

1. Remove all packaging materials.
2. Wipe the surfaces of the appliance with a damp cloth or sponge and dry with a cloth.

### Initial heating

**IMPORTANT:**

Smoke and smell may emit for a couple of hours during the initial operation. This is quite normal. Ensure that the room is well ventilated to remove the smoke and smell. Avoid directly inhaling the smoke and the smell that emits.

Heat up the product for about 30 minutes and then switch it off. Thus, any production residues or layers will be burnt off and removed.

**WARNING**

Hot surfaces cause burns! Product may be hot when it is in use. Never touch the hot burners, inner sections of the oven, heaters and etc. Keep children away. Always use heat resistant oven gloves when putting in or removing dishes into/from the hot oven.

### Electric oven

1. Take all baking trays and the wire grill out of the oven.
2. Close the oven door.
3. Select the bake function.
4. Set the temperature 175 °C (350° F).
5. Operate the oven about 30 minutes.
6. Turn off your oven.

### Broil

1. Take all baking trays and the wire grill out of the oven.
2. Select the broil function.
3. Set the broil level to "HI".
3. Operate the broil about 30 minutes.
4. Turn off your oven.



Smoke and smell may emit for a couple of hours during the initial operation. This is quite normal. Ensure that the room is well ventilated to remove the smoke and smell. Avoid directly inhaling the smoke and the smell that emits.

## 4 How to use the hob

### General information about cooking

 **WARNING**  
Never fill the pan with oil more than one third of it. Do not leave the hob unattended when heating oil. Overheated oils bring risk of fire. **Never attempt to extinguish a possible fire with water!** When oil catches fire, cover it with a fire blanket. Turn off the hob if it is safe to do so and call the fire department.

 **CAUTION**  
Never extend the flame beyond the outer edge of the cooking utensil. A higher flame wastes energy, and increases your risk of being burned by the flame

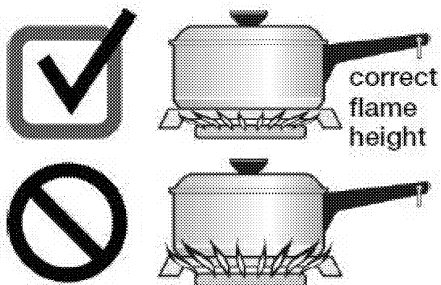

- Before frying foods, always dry them well and gently place into the hot oil. Ensure complete thawing of frozen foods before frying.
- Do not cover the vessel you use when heating oil.
- Place the pans and saucepans in a manner so that their handles are not over the hob to prevent heating of the handles. Do not place unbalanced and easily tilting vessels on the hob.
- Do not place empty vessels and saucepans on cooking zones that are switched on. They might get damaged.
- Operating a cooking zone without a vessel or saucepan on it will cause damage to the product. Turn off the cooking zones after the cooking is complete.

- As the surface of the product can be hot, do not put plastic and aluminum vessels on it. Such vessels should not be used to keep foods either.
  - Use flat bottomed saucepans or vessels only.
  - Put appropriate amount of food in saucepans and pans. Thus, you will not have to make any unnecessary cleaning by preventing the dishes from overflowing. Do not put covers of saucepans or pans on cooking zones.
- Place the saucepans in a manner so that they are centered on the cooking zone. When you want to move the saucepan onto another cooking zone, lift and place it onto the cooking zone you want instead of sliding it.

### Gas cooking

- Size of the vessel and the flame must match each other. Adjust the gas flames so that they will not extend the bottom of the vessel and center the vessel on saucepan carrier.

### Using the hobs

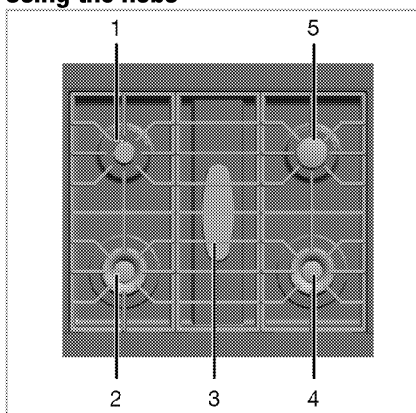

- 1 Auxiliary burner 18-22 cm ( 7- 8.66 inches)
- 2 **Wok burner** 24-28 cm ( 9.44 - 11 inches)
- 3 Elongated burner min. 36-15 cm ( 14.17 - 5.9 inches)
- 4 Wok burner 24-28 cm ( 9.44 - 11 inches)
- 5 Normal burner 18-22 ( 7- 8.66 inches) cm is list of advised diameter of pots to be used on related burners.

## Igniting the gas burners

Gas burners are controlled with gas hob knobs.

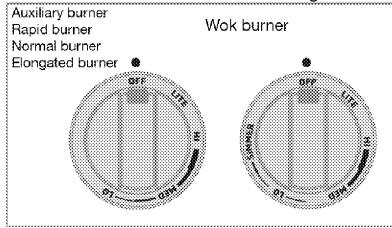

1. Keep burner knob pressed.
2. Turn it counter clockwise to level "LITE".  
Gas is ignited with the spark created.
3. Adjust it to the desired cooking power.

## Turning off the gas burners

Turn the knob to off (upper) position.

### Wok burner

Wok burners help you to cook faster. Wok, which is particularly used in Asian kitchen is a kind of deep and flat fry-pan made of sheet metal, which is used to cook minced vegetable and meat at strong flame in a short time.

Since meals are cooked at strong flame and in a very short time in such fry-pans that conduct the heat rapidly and evenly, the nutrition value of the food is preserved and vegetables remain crispy. You can use wok burner for regular saucepans as well.

## 5 How to operate the oven

### General information on baking, roasting and broiling



#### WARNING

Hot surfaces cause burns!  
Product may be hot when it is in use. Never touch the hot burners, inner sections of the oven, heaters and etc. Keep children away. Always use heat resistant oven gloves when putting in or removing dishes into/from the hot oven.



#### DANGER:

Be careful when opening the oven door as steam may escape.  
Exiting steam can scald your hands, face and/or eyes.

### Tips for baking

- Use non-sticky coated appropriate metal plates or aluminum vessels or heat-resistant silicone moulds.
- Make best use of the space on the rack.
- Place the baking mould in the middle of the shelf.
- Select the correct rack position before turning the oven or Broil on. Do not change the rack position when the oven is hot.
- Always place oven racks in desired location while oven is cool. If rack must be moved while oven is hot, do not let potholder contact hot heating element in oven.
- Keep the oven door closed.

### Tips for roasting

- Seasoning with lemon juice and black pepper will improve the cooking performance when cooking a whole chicken, turkey or a large piece of meat.
- Meat with bones takes about 15 to 30 minutes longer before it is cooked than a roast of the same size without bones.
- You should calculate about 4 to 5 minutes cooking time per centimeter height of the meat.
- Let meat rest in the oven for about 10 minutes after the cooking time. The juice is better distributed all over the roast and does not run out when the meat is cut.

- Fish in a fire-resistant dish should be placed on the rack at the medium or lower level.

### Tips for broiling

Broiling is ideal for cooking meat, fish and poultry and will achieve a nice brown surface without it drying out to much. Flat pieces, meat skewers and sausages are particularly suited for broiling as are vegetables with a high water content such as tomatoes and onions.

- Distribute the pieces to be broiled on the wire shelf.
- If the broiling is on the wire shelf, locate a dripping pan under it in order to collect the fat.
- Add some water in dripping pan for easy cleaning.



#### Fire danger due to food which is unsuitable for grilling!

Only use food for grilling which is suitable for intensive grilling heat. Do not place the food too far in the back of the grill. This is the hottest area and fat food may catch fire.



#### WARNING

Do not insert your finger or any other object in the holes of the back wall of the oven.

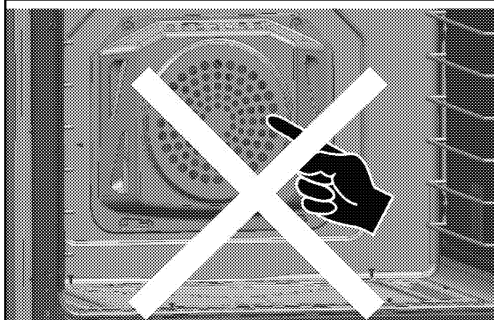

Fan only runs if necessary for improving performance of cooking and saving the energy of the oven.

### Tips for cooking vegetables

1. If the vegetable dish runs out of juice and gets to dry,



» Since using a lid during cooking will keep the juice of the dish in the pan, cook your vegetable dishes in a pan with a lid instead of a tray.

2. If a vegetable dish does not get cooked,

» Boil the vegetables beforehand or prepare them like canned food and put in the oven.

### Shelf positions

For optimum broil coverage, position the wire shelf towards the front of the oven just out of contact with the glass door. Placing the wire shelf fully to the rear of the oven will reduce the broil coverage. It is important to position the wire shelf on side rack correctly. The wire shelf must be placed so that it will fit into the opening of the wire shelf as illustrated in the figure.

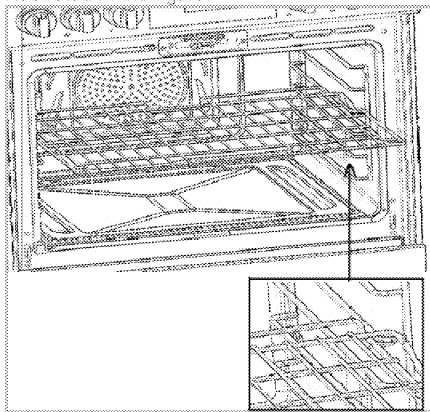

### How to use the electric oven

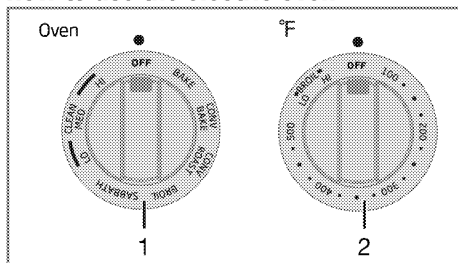

- 1 Function knob
- 2 Thermostat knob

1. Set the Function knob to the desired operating mode.
2. Set the Temperature knob to the desired temperature.

» Oven heats up to the adjusted temperature and maintains it. During heating, temperature lamp stays on.

### Switch off the electric oven

1. Turn the function and thermostat knobs to off (upper) position.

### Cooking Functions

#### Bake

Only bottom heat is on. The bake mode can be used for a variety of food items, from cakes to casseroles.

Bake food on a single rack with the pans are positioned in the middle of the oven. Bake foods with 1" (25mm) to 1.5" (38mm) space between pans and oven walls.

When using the Bake mode, preheat the oven for best results.

Baking time will vary with the size, shape and material of the pan used.

#### Convection Bake

Only bottom heat is on. The heat comes from bottom and is circulated throughout the oven by the convection fan. The convection bake mode can be used for a variety of food items, from cakes to breads.

It is also ideal for sponge cakes, pasties and biscuits on multiple racks (3 and 5) at the same time and large quantities of baked foods.

The cakes are positioned with the top rack cakes towards the back of the oven and the lower rack cakes towards the front of the oven. Bake foods with 1" (25mm) to 1.5" (38mm) space between pans and oven walls.

When using the Convection Bake mode, preheat the oven for best results.

Baking time will vary with the size, shape and material of the pan used.

#### Convection Roast

Top and bottom heat are on. The heat comes from top and bottom and is circulated throughout the oven by the convection fan. The convection roast mode can be used for meat, poultry and large quantities of roasted foods.

Roast food on a single rack with the pan is positioned in the middle of the oven.

When using the Convection Roast mode, preheat the oven for best results.

For best performance, use a pan and grid (roasting tray or broiler tray) under the meat or poultry. The pan catches grease spills.

	<b>WARNING</b> Do not cover meat or use roasting bags in this mode.
--	--

### Broil

Top heat is on. The broil mode can be used for cuts of meat, poultry and fish. It can also be used to brown breads. The food must be put on a grid in a pan (broiler tray).

Broil food on a single rack with the broiler tray are centrally located with respect to the heating element.

The broil mode has two settings: low "LO" and high "HI".

When using the Broil mode, preheat the oven 5-6 minutes for best results.

Turn foods once during the recommended cook time.

The size, weight, thickness, starting temperature and personal preference of doneness will affect broiling times.

### Sabbath

Only bottom heat is on.

Cook food on a single rack with the pans are positioned in the middle of the oven. Cook foods with 1" (25mm) to 1" ½ "(38mm) space between pans and oven walls.

	The maximum time for Sabbath mode is 75 hours.
---	--

	<b>IMPORTANT:</b> Light is off when the Sabbath function is used. No change in light if you press the button without Sabbath mode.
--	---

	<b>WARNING:</b> Food Poisoning Hazard: Do not let food sit in oven for more than 1 hour before or after cooking. Doing so can result in food poisoning or sickness.
--	--

	<b>WARNING:</b> To avoid permanent damage to the oven bottom finish do not line the oven bottom with any type of foil or liner.
--	--

	<b>WARNING:</b> Sabbath mode should be used only on the Jewish Sabbath and Holidays.
---	---

	<b>WARNING:</b> The health of some birds and pets is extremely sensitive to the fumes given off during the Sabbath mode. Always move birds and pets to another closed and well ventilated room. Keep the kitchen well-ventilated during the Sabbath mode also for your health.
---	---

	All food should be placed in the oven before the Sabbath begins, since none may be placed in the oven during the Sabbath.
---	---

	On the Sabbath the oven door may only be opened once, all the food removed and then closed. On the Holidays, the oven door may be opened/closed at any time as often as desired.
---	--

### Bullnose

The bullnose lights can be illuminated with illumination for control panel button.

## Cooking times table



1st rack of the oven is the **bottom** rack.



The timings in this chart are meant as a guide. Timings may vary due to temperature of food, thickness, type and your own preference of cooking.

## Baking and roasting

Food	Cooking Mode	Oven Temperature (°F/°C)	Number of Racks	Rack Position	Time (min.)	Pan Size&Type	Explanation
Sponge Cake	Bake	350/175	Single	3	20-30	8" or 9" (200-230 mm) round	The cakes are positioned in the middle of the oven. Bake foods with 1" (25mm) to 1.5" (38mm) space between pans and oven walls.
Sponge Cake	Convection Bake	325/160	Multiple	3&5	20-30	8" or 9" (200-230 mm) round	The cakes are positioned with the top rack cakes towards the back of the oven and the lower rack cakes towards the front of the oven. Bake foods with 1" (25mm) to 1.5" (38mm) space between pans and oven walls.
Loaf (leavened*)	Bake	400/205	Single	3	30-40	Baking tray	-
Loaf (leavened*)	Convection Bake	400/205	Single	3	25-35	Baking tray	-
Puff pastry	Convection Bake	375/190	Multiple	3&5	15-20	Cookie sheet	The sheets are positioned with the top rack sheet towards the back of the oven and the lower rack sheet towards the front of the oven. Bake foods with 1" (25mm) to 1.5" (38mm) space oven walls.
Fresh pizza, thin	Convection Bake	425/220	Single	2	8-15	Pizza pan or Baking tray	-
Fresh pizza, thick	Convection Bake	425/220	Single	2	12-20	Pizza pan or Baking tray	-
Frozen pizza, thick	Convection Bake	425/220	Single	2	10-15	Pizza pan or Baking tray	-
Chicken, whole (4-4.5 lbs.)	Convection Roast	375/190	Single	2	120-140	Roasting pan or broiler tray	Minimum internal temperature is 180°F (82 °C) in thigh
Turkey, whole, unstuffed (18-20 lbs.)	Convection Roast	325/160	Single	1	150-180	Roasting pan	Minimum internal temperature is 180°F (82 °C) in thigh. Foil the top surface of turkey to prevent over-browning in last 30 minutes of the cooking, if necessary.
Sirloin, boneless (4-4.5 lbs.)	Convection Roast	325/160	Single	3	90-120	Broiler tray	Internal temperature is 145°F (62 °C) (medium rare), 160°F (71 °C) (medium)
Toast bread	Broil	High	Single	5	2-2:30	Broiler tray	Place broiler tray centrally located with respect to the heating element.
Chicken thigh (2-2.5 lbs)	Broil	High	Single	4	Side 1: 16-20 Side 2: 8-12	Broiler tray	Place broiler tray centrally located with respect to the heating element. Minimum internal temperature is 180°F (82 °C) in thigh.
Chicken thigh (2-2.5 lbs)	Broil	Mid	Single	4	Side 1: 20-24 Side 2: 14-16	Broiler tray	Place broiler tray centrally located with respect to the heating element. Minimum internal temperature is 180°F (82 °C) in thigh.
Ground beef (0.3"-0.5" thick, 6 patties)	Broil	High	Single	4	Side 1: 5-7 Side 2: 3-5	Broiler tray	Place broiler tray centrally located with respect to the heating element.

Hamburger, frozen (0.3"-0.5" thick, 6 patties)	Broil	High	Single	4	Side 1: 7-10 Side 2: 2-4	Broiler tray	Place broiler tray centrally located with respect to the heating element.
*Leavening	Bake	100/40	Single	3	30-40	Bowl or pan with cover	

\*\*It is suggested to perform preheating for all foods cooking.  
It is suggested to perform 5-6 minutes preheating for all foods broiling.

## How to operate the broil



**WARNING**  
Hot surfaces may cause burns! Keep children away from the product.  
Close oven door during grilling.

The broil is operated by the function and thermostat knob. In off position (top) the gas supply is locked.

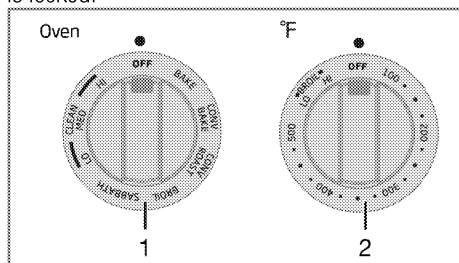

- 1 Function knob
- 2 Thermostat knob

### Switching on Broil

1. Keep the function knob pressed and turn it **clockwise** to the "Broil".
2. Keep the thermostat knob pressed and turn it **clockwise** to the "HI" or "LO" level on "Broil".
3. After 30-75 seconds, the burner will operate.



**CAUTION:**  
When thermostat knob is turned to the "Broil-LO" or "Broil-Hi", functions except "Broil" and "Self-Clean" will not operate.

### Switch off broil

1. Turn the function and thermostat knobs to off (upper) position.

### For equipment with a cooling fan

The cooling fan cools the front of the products.

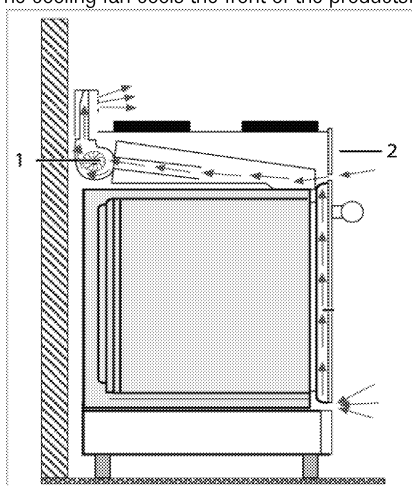

- 1 Cooling fan motor
- 2 Front door



**IMPORTANT:**  
The cooling fan continues to operate for about 20-30 minutes after the oven is switched off.

## 6 Maintenance and care

### General information

Service life of the product will extend and the possibility of problems will decrease if the product is cleaned at regular intervals.



#### DANGER:

Disconnect the product from mains supply before starting maintenance and cleaning works.

There is the risk of electric shock!



#### DANGER:

Allow the product to cool down before you clean it.

Hot surfaces may cause burns!



#### IMPORTANT:

The surface might get damaged by some detergents or cleaning materials.

Do not use aggressive detergents, cleaning powder/cream or any sharp objects. Do not use aggressive detergents, cleaning powder/cream or any sharp objects.

- Keep the appliance area clear and free from combustible materials, gasoline and other flammable vapors and liquids.
- Do not obstruct the flow of combustion and ventilation air.
- Clean the product thoroughly after each use. In this way it will be possible to remove cooking residues more easily, thus avoiding these from burning the next time the appliance is used.



#### IMPORTANT:

No special cleaning agents are required for cleaning the appliance. It is recommended to use warm water with washing liquid, a soft cloth or sponge and use a dry cloth for drying.

- Do not use any abrasive cleaning materials!
- Always ensure any excess liquid is thoroughly wiped off after cleaning and any spillage is immediately wiped dry.
- Do not use cleaning agents that contain acid or chloride to clean the stainless or

inox surfaces and the handle. Use a soft cloth with a liquid detergent (not abrasive) to wipe those parts clean, paying attention to sweep in one direction.



The surface might get damaged by some detergents or cleaning materials.

Do not use aggressive detergents, cleaning powders/creams or any sharp objects during cleaning.

Do not use harsh abrasive cleaners or sharp metal scrapers to clean the oven door glass since they can scratch the surface, which may result in shattering of the glass.



#### WARNING:

Do not use steam cleaners to clean the appliance as this may cause an electric shock.

### Cleaning the burner/plate

#### Gas hobs

1. Remove and clean the saucepan carriers and burner caps.
2. Clean the hob.
3. Refit the burner caps and make sure that they are seated correctly.
4. When installing the pan supports, pay attention to place the saucepan carriers so that the burners are centered.

### Cleaning the control panel

Clean the control panel and knobs with a damp cloth and wipe them dry.



Do not remove the control buttons/knobs to clean the control panel.

Control panel may get damaged!

### Cleaning the oven

No oven cleaner or any other special cleaning agent is required for cleaning the oven. It is recommended to wipe the oven with a damp cloth while it is still warm.

**To clean the side wall,** unscrew the 4 screws on the steel rack. After cleaning operation, assemble the steel rack to the oven body again.

Do not damage the balancing stands when cleaning the cast grill.

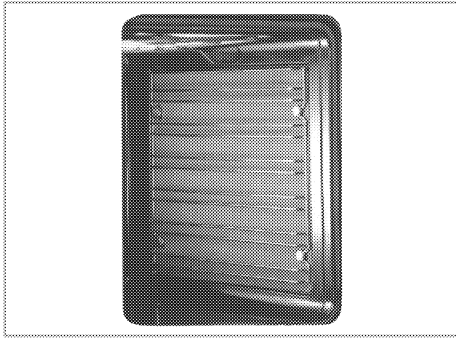

## Self-cleaning function



### WARNING:

If the oven is hot, self cleaning mode can not be operated until the oven is cold. If the self cleaning mode malfunctions (powercut), turn the oven off and disconnect the power supply, and call the service.

Oven

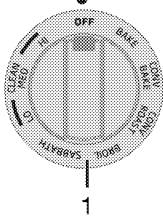

1

Function knob

°F

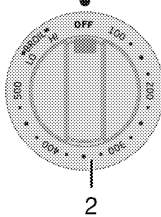

2

2 Thermostat knob



### DANGER:

Hot surfaces cause burns!

Do not touch the product during self cleaning step and keep children away from it. Keep at least 30 minutes before removing the remnants.

The oven is equipped with self-cleaning function.

The oven is heated to approx. (790 °F) 421°C and existing dirt is burned to ashes. A strong smoke development may arise. Provide for good ventilation. The self-cleaning should be used after approx. every 10th oven usage.

The self-cleaning has three levels. It can be selected according to level of dirtiness.

**Low (LO):** it takes 3 hours.

**Medium (MED):** it takes 4 hours.

**High (HI) :** it takes 5 hours.

1. Remove all accessories from the oven.
2. Before the self-cleaning cycle, remove dirt from exterior surfaces and oven interior with a damp cloth.



### WARNING:

If the self-cleaning mode malfunctions, turn the oven off and disconnect the power supply. Have it serviced by a qualified technician.



### WARNING:

Before operating the self-clean cycle. Wipe grease and food soils from the oven. Excessive amount of grease may ignite, leading to smoke damage to your home.



### WARNING:

Do not clean the door gasket. Fiberglass gasket is highly sensitive and can get damaged easily. In case of a damage on the oven door gasket, replace with the new one from the authorized service.



### WARNING:

Before operating the self-clean cycle, remove dirt from exterior surfaces and oven interior with a damp cloth, wipe grease and food soils from the oven. Excessive amount of grease may ignite, leading to smoke damage to your home. Remove all accessories from the oven.

3. Keep the function knob pressed and turn it **clockwise** to desired level of "Clean". (LO, MED or HI).

This duration cannot be changed.



### WARNING:

The health of some birds and pets is extremely sensitive to the fumes given off during the Self-Cleaning cycle. Always move birds and pets to another closed and well ventilated room. Keep the kitchen well-ventilated during the Self-Cleaning cycle also for your health.

4. Oven door cannot be opened during self cleaning. It remains locked for a while after the self-cleaning function ends. Do not force the door lock with handle until the oven get cool.
5. After a clean cycle, remove soil deposits with vinegar water.

**i** During the Self-Cleaning cycle, the gas flow to hob burners will be cut. After turning the function and thermostat knob to off position, the door lock will be automatically opened. When the oven gets cool, the gas flow to hob burners will be started.

**i** During the Self-Cleaning cycle, the lamp cannot be operated.

**WARNING:**  
If there is a fire in the oven during self-clean, turn the oven off and wait for the fire to go out. Do not force the door open. Introduction of fresh air at self-clean temperatures may lead to a burst of flame from the oven. Failure to follow this instruction may result in severe burns.

### Clean oven door

To clean the oven door, use warm water with washing liquid, a soft cloth or sponge to clean the product and wipe it with a dry cloth.

**i** Don't use any harsh abrasive cleaners or sharp metal scrapers for cleaning the oven door. They could scratch the surface and destroy the glass.

### Removing the oven door

When removing the oven door, make sure oven is cool and power to the oven has been turned off before removing the door.

Failure to do so could result in electrical shock or burns.

The oven door is heavy and parts of it are fragile. Use both hands to remove the oven door. The door front is glass. Handle carefully to avoid breakage.

Grasp only the sides of the oven door. Do not grasp the handle as it may swing in your hand and cause damage or injury.

Failure to grasp the oven door firmly and properly could result in personal injury or product damage.

To avoid injury from hinge bracket snapping closed, be sure that both levers are securely in place before removing the door. Also, do not force door open or closed—the hinge could be damaged and injury could result.

Do not lay removed door on sharp or pointed

objects as this could break the glass. Lay on a flat, smooth surface, positioned so that the door cannot fall over.

Oven door can be removed in order to clean the inside of oven easily

1. Open the oven door completely.
2. Press the hinge clamps located at both sides of the door backwards.

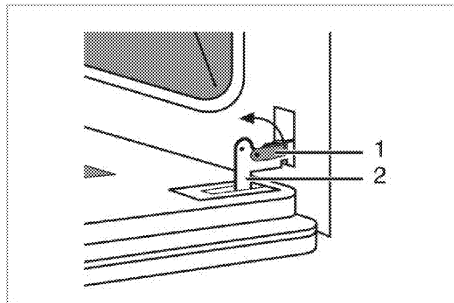

- 1 Hinge clamp  
2 Hinge

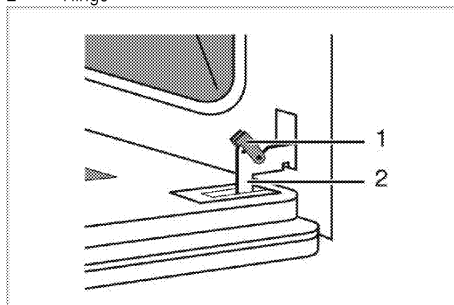

3. Move the oven door to a slightly inclined position.
4. Raise the oven door forwards with your two hands.
5. Once you complete cleaning, perform the same procedure in reverse order to reinstall the oven door.

**i** Once you complete cleaning, perform the same procedure in reverse order to reinstall the oven door.

## Replacing the oven lamp



### DANGER:

Before replacing the oven lamp, make sure that the product is disconnected from mains and cooled down in order to avoid the risk of an electrical shock.

Hot surfaces may cause burns!



The oven lamp is a special electric light bulb that can resist up to 300°C (573 °F). See *Technical specifications* for details. Oven lamps can be obtained from Authorised Service Agents or technician with license.



Position of lamp might vary from the figure.

### If your oven is equipped with a square lamp:

The oven lights can be illuminated with lamp button. The lights are switched on when the oven is in a cooking cycle.

The oven lights are not illuminated during self clean. Each light assembly consist of a removable lens, a light bulb as well as a light socket housing that is fixed in place. Light bulb replacement is considered to be a routine maintenance item.

The oven lights are not illuminated during self clean.

1. Turn off power at the main power supply (your fuse or breaker box).
2. Remove the wire racks as described. See *Cleaning the oven*.

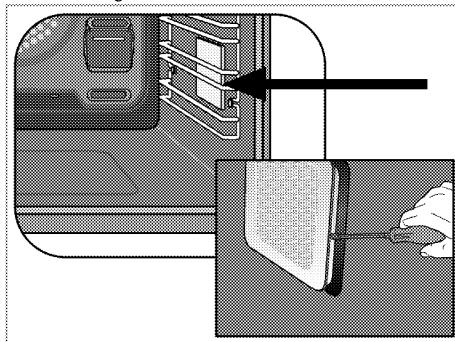

3. Remove the protective glass cover with a screwdriver.
4. Pull out oven lamp and replace it with new one.
5. Install the glass cover and then the wire racks.



## 7 General information

### Overview

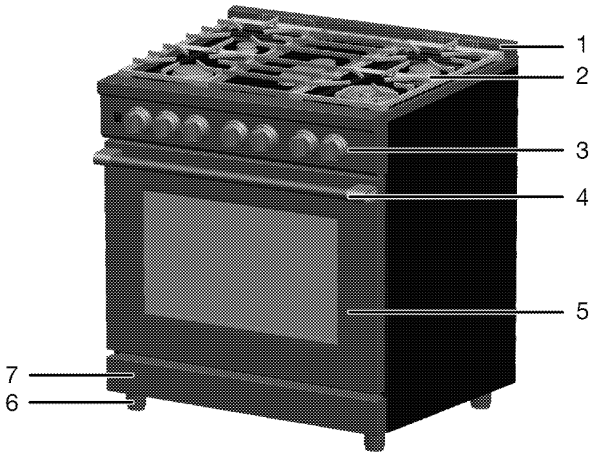

- |   |               |   |            |
|---|---------------|---|------------|
| 1 | Splashback    | 5 | Front door |
| 2 | Burner plate  | 6 | Foot       |
| 3 | Control panel | 7 | Lower part |
| 4 | Handle        |   |            |

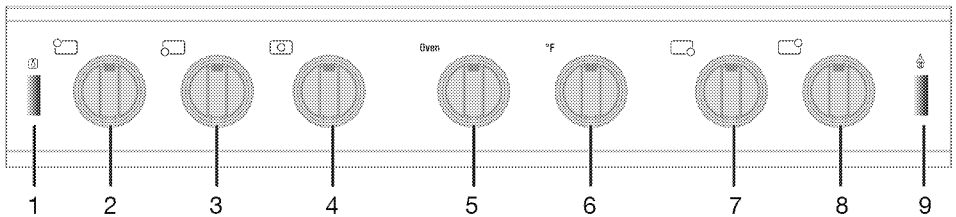

- |   |                            |   |                                |
|---|----------------------------|---|--------------------------------|
| 1 | Oven lamp button           | 6 | Thermostat knob                |
| 2 | Auxiliary burner Rear left | 7 | Wok burner Front right         |
| 3 | Wok burner Front left      | 8 | Normal burner Rear right       |
| 4 | Elongated burner Middle    | 9 | Illumination for control panel |
| 5 | Function knob              |   |                                |

## Technical specifications

GENERAL	
External dimensions (height / width / depth)	36 x 29 <sup>13/16</sup> x 29 <sup>1/8</sup> inches(914x757x739 mm)
Voltage / frequency	220- 240V~60Hz 2AC~N
Cable type / section	SJT 12x4 AWG
Fuse protection	Min. 20 A
Cable length	max. 6ft
Total electric power	4 kW
Gas type / pressure	Natural Gas 5" WC /LP Gas 10" WC
Burners	
Rear left	<b>Auxiliary burner</b>
Power	4000 BTU/h / 3000 BTU/h
Front left	<b>Wok burner</b>
Power	20000 BTU/h / 16500 BTU/h
Middle	<b>Elongated burner</b>
Power	10000 BTU/h / 8250 BTU/h
Front right	<b>Wok burner</b>
Power	20000 BTU/h / 16500 BTU/h
Rear right	<b>Normal burner</b>
Power	8000 BTU/h / 6500 BTU/h
OVEN/GRILL	
<b>Main oven</b>	<b>Multifunction oven</b>
Inside illumination	2 x 40 W
Bake	2240 W
Broil	3320 W
Convection Roast	3670 W
* Powers are for 230 V 2AC ~ N	



Technical specifications may be changed without prior notice to improve the quality of the product.



Figures in this manual are schematic and may not exactly match your product.



Values stated on the product labels or in the documentation accompanying it are obtained in laboratory conditions in accordance with relevant standards. Depending on operational and environmental conditions of the product, these values may vary.

## Package contents



### WARNING:

Pull the oven rack to the stop-lock position when loading and unloading food from the oven. This helps prevent burns from touching hot surfaces of the door and oven walls.



### CAUTION:

When you are using a rack in the lowest position (A), you will need to use caution when pulling the rack out. We recommend that you pull the rack out several inches and then, using two pot holders, pull the rack out by holding the sides of it. The rack is low and you could be burned if you place your hand in the middle of the rack and pull all the way out. Be very careful not to burn your hand on the door when using the rack in the lowest position (A).



Accessories supplied can vary depending on the product model. Not every accessory described in the user manual may exist on your product.

1. **User manual**

2. **Oven tray**

Used for pastries, frozen foods and big roasts.

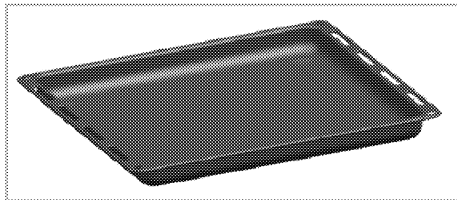

3. **Wire Shelf**

Used for roasting and for placing the food to be baked, roasted or cooked in casserole dishes to the desired rack.

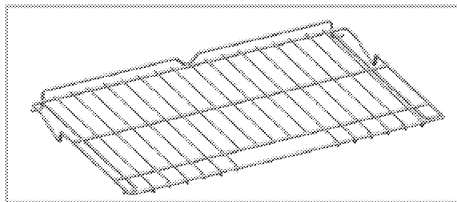

4. **Broiler tray**

It is placed onto the tray in order to collect the dripping fat while grilling so that the oven is kept clean.

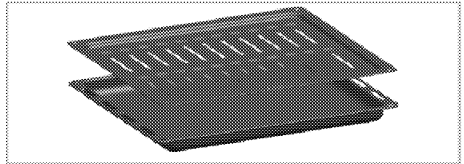
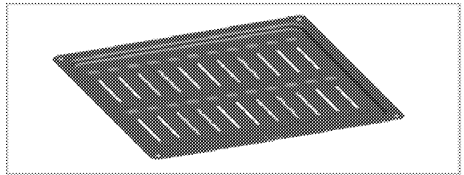

5. **Placing the wire shelf and tray onto the telescopic racks properly**

Telescopic racks allow you to install and remove the trays and wire shelf easily. When using the tray and wire shelf with telescopic racks, make sure that the pins at the rear section of the telescopic rack stands against the edges of the wire shelf and tray.

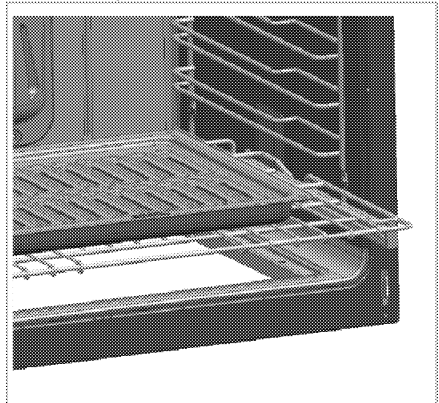

## 6. Griddle



Griddle is an optional accessory, should be bought from authorized dealer.



### CAUTION:

**BURN HAZARD:** Griddle surfaces may be hot enough to cause burns during and after use. Please remove the griddle when it is cool and all surface units are off. Use oven mitts if you will touch the griddle while hot. Failure to do so can result in burns.



### CAUTION:

Before using this cookware for the first time, wash it to make sure it is clean. Then season it lightly, rubbing cooking oil onto the nonstick surface.



**IMPORTANT:** Always place and use your griddle at the designated location on the fish burner (Elongated burner), above middle cast iron pan support.

Clean the griddle with a sponge and mild detergent in warm water. DO NOT use blue or green scrubbing pads or steel wool.

Avoid cooking extremely greasy foods and be careful of grease spillover while cooking.

Never place or store any items on the griddle, even when it is not in use. The griddle can become heated when using the surrounding surface units.

Avoid using metal utensils with sharp points or rough edges, which might damage the griddle. Do not cut food on the griddle.

Do not use cookware as a storage container for food or oil. Permanent staining and/or crazelings could result.

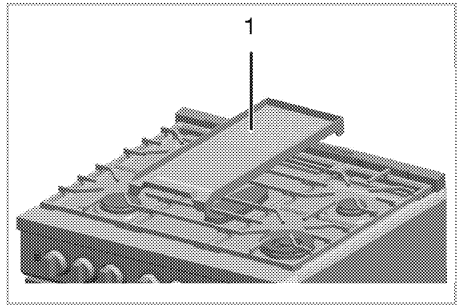

1 Griddle



Griddle is made of cast iron and heavy, therefore please be careful when handling.



Griddle is designed only for use on elongated burner.

**Griddle becomes very hot while it is in use. Keep children away from the oven.**

Used to cook your food directly. Remove the pan support of elongated burner. Place the griddle onto the elongated burner and do not put any vessels on it.

- Metal utensils such as spatulas can damage the cooking surface.
- Be sure the griddle fits properly.
- Heat the griddle for max. 20 minutes before putting food on it. It may get damaged if it is heated for longer.

## Injector table



### WARNING:

This product can be converted to LP Gas. Gas conversion must always be performed by Authorized Service Agents.

According to the gas type that will be used, the correct injector type must be used. Please find the LPG/NG table below.

Position hob zone	4000 BTU/h Rear left	20000 BTU/h Front left		20000 BTU/h Front right		8000 BTU/h Rear right	10000 BTU/h Middle
Gas type / Gas pressure							
Natural Gas 5"	92	inner 75	outer 143	inner 75	outer 143	125	139

Position hob zone	3000 BTU/h Rear left	16500 BTU/h Front left		16500 BTU/h Front right		6500 BTU/h Rear right	8250 BTU/h Middle
Gas type / Gas pressure							
LP Gas 10"	55	inner 46	outer 80	inner 46	outer 80	75	85

## 8 Troubleshooting

### **Oven emits steam when it is in use.**

- It is normal that steam escapes during operation. >>> *This is not a fault.*

### **Product emits metal noises while heating and cooling.**

- When the metal parts are heated, they may expand and cause noise. >>> *This is not a fault.*

### **Product does not operate.**

- The mains fuse is defective or has tripped. >>> *Check fuses in the fuse box. If necessary, replace or reset them.*
- Product is not plugged into the (grounded) socket. >>> *Check the plug connection.*

### **There is no ignition spark.**

- No current. >>> *Check fuses in the fuse box.*

### **Oven light does not work.**

- Oven lamp is defective. >>> *Replace oven lamp.*
- Power is cut. >>> *Check if there is power. Check the fuses in the fuse box. If necessary, replace or reset the fuses.*

### **Oven does not heat.**

- Function and/or Temperature are not set. >>> *Set the function and the temperature with the Function and/or Temperature knob/key.*
- Power is cut. >>> *Check if there is power. Check the fuses in the fuse box. If necessary, replace or reset the fuses.*

### **There is no gas.**

- Main gas valve is closed. >>> *Open gas valve.*
- Gas pipe is bent. >>> *Install gas pipe properly.*

### **Burners are not burning properly or at all.**

- Burners are dirty. >>> *Clean burner components.*
- Burners are wet. >>> *Dry the burner components.*
- Burner cap is not mounted safely. >>> *Mount the burner cap properly.*
- Gas valve is closed. >>> *Open gas valve.*



Consult the Authorised Service Agent or technician with licence or the dealer where you have purchased the product if you can not remedy the trouble although you have implemented the instructions in this section. Never attempt to repair a defective product yourself.

## 9 Removing the Package

1

Ribbon

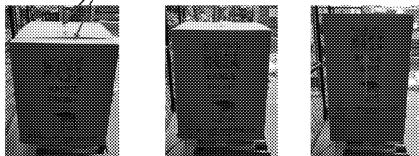

2

Upper Frame

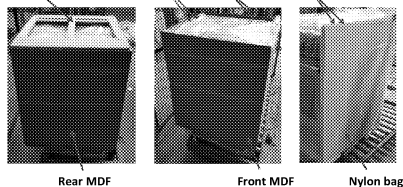

Rear MDF

Front MDF

Nylon bag

A: 18x40 Wooden support

Remove upper frame and rear and front MDFs.

3

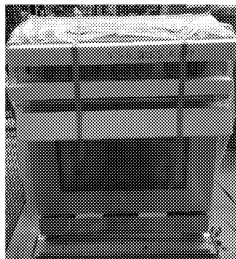

Remove cut-out styrofoams and blue tapes.

4



Remove nylon bag on the product.

5

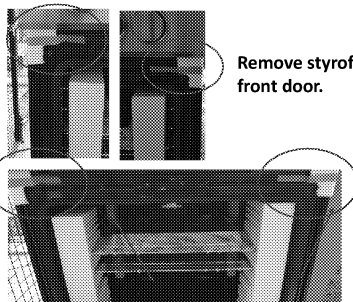

Remove styrofoams of the front door.

6

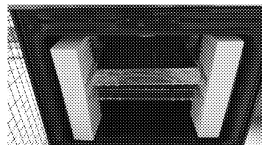

Remove grill styrofoams and shrink packaging.

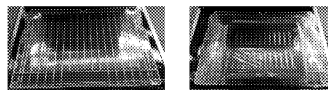

7

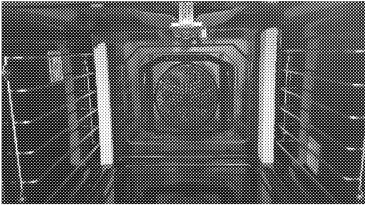

Remove protective styrofoams on chassis inside the.

8

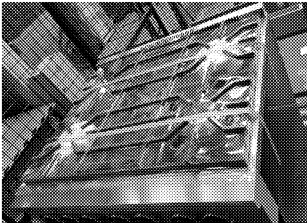

Remove upper pet and blue tapes on it

9



Remove blue tapes on the edges of cast grill.

10



Remove styrofoams on pet and the lower pet.

11

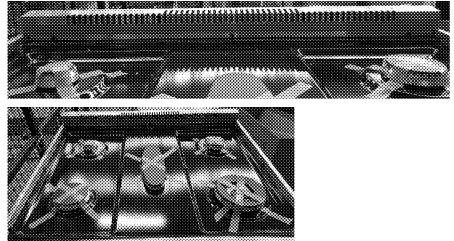

Remove blue tapes securing splash back and burner caps.

12



- Remove 3 screws on each of the 4 L-brackets.
- Remove rear connection plate by removing 6 screws on the palette and 3 screws on the product and take the product out.

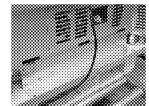
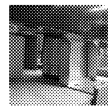
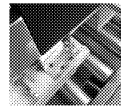

13

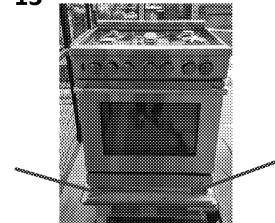

Take the product from the palette by holding it from its bottom after separating it from the palette. Place the product to the desired location.



# 10 WARRANTY STATEMENT FOR BLOMBERG ELECTRIC AND GAS RANGES

The warranties provided by Blomberg in these statements only apply to Blomberg electric and gas ranges sold to the original purchaser or homeowner in the US and Canada. This warranty is not transferable.

To obtain warranty service, please contact our nearest distributor as listed by state or call 1800-459-9848. You will need your electric and gas range model number, serial number, retailer name and address, where purchased and purchase date / installation date.

This warranty gives you specific legal rights, and you may also have other rights which vary from state to state.

All warranties stated below are based upon normal household use. The use of the product in a commercial setting will void all warranties.

Service must also be performed by an authorized Blomberg Service Agency.

Cosmetic defects must be reported within 10 business days from installation

1 year \* limited warranty from date of first installation Blomberg will repair or replace at no cost to the consumer any defective parts of the electric and gas ranges

2 year \* ++ limited warranty from date of first installation (Parts only) Blomberg will repair or replace any parts at no cost to the consumer if material defects or workmanship have caused the damage or failure of these components. Labor charges are the responsibility of the consumer

2-5 year \* ++ limited warranty from date of first installation (Parts only) Blomberg will repair or replace oven cavity at no cost to the consumer if material defects or workmanship have caused the damage or failure of these components. Labor charges are the responsibility of the consumer

Disclaimers of warranties and exclusions:

Warranty does not cover service costs by an authorized service agent to correct installation, electrical problems or educational instruction on the use of the electric and gas ranges. The warranty also does not cover defects or damage caused by an act of god (such as storms, floods, fires, mudslides, etc.), damage cause by use of the electric and gas ranges for purposes other than those for which it was designed, misuse, abuse, accident, alteration, improper installation, maintenance, travel fees, service calls outside normal service hours, unauthorized service work or work.

This product is fully tested and went through official quality assurance inspections before leaving the original manufacturing site. Warranty

terms for this Blomberg household appliance is not valid if the product is altered, tampered, modified, additional parts assembled, fixed and re-packed by an authorized distributor, service, a third party retailer, reseller or by any other unauthorized person(s).

TO THE EXTENT PERMITTED BY LAW, THIS WARRANTY IS IN LIEU OF ALL OTHER EXPRESSED AND IMPLIED WARRANTIES, INCLUDING THE IMPLIED WARRANTIES OF MERCHANTABILITY AND FITNESS FOR A PARTICULAR PURPOSE. BLOMBERG UNDERTAKES NO RESPONSIBILITY FOR THE QUALITY OF THIS PRODUCT EXCEPT AS OTHERWISE PROVIDED IN THIS WARRANTY STATEMENT. BLOMBERG ASSUMES NO RESPONSIBILITY THAT THE PRODUCT WILL BE FIT FOR ANY PARTICULAR PURPOSE FOR WHICH YOU MAY BE BUYING THIS PRODUCT, EXCEPT AS OTHERWISE PROVIDED IN THIS WARRANTY STATEMENT.

Blomberg does not assume any responsibility for incidental or consequential damages. Such damages include, but are not limited to, loss of profits, loss of savings or revenue, loss of use of the cooker or any associated equipment, cost of capital, cost of any substitute equipment, facilities or services, downtime, the claims of third parties, and injury to property. Some states do not allow the exclusion or limitation of incidental or consequential damages, so the above limitations or exclusion may not apply to you.

\* installation date shall refer to either purchase date or 5 business days after delivery of the product to the home, whichever is later.

++Parts replaced will assume the identity of the original parts + their original warranty.

No Other Warranties. This Warranty Statement is the complete and exclusive warranty from the manufacturer. No employee of Blomberg or any other party is authorized to make any warranty statements in addition to those made in this Warranty Statement.

Please keep this warranty card, user manual and your sales slip for future reference.

#### HOW TO GET SERVICE

Please contact the Distributor for your State or Province as listed on the Distributor Contact List, or call our Toll Free Number at 1 800 459 9848 for direction to an Authorized Blomberg Service Agent. 0201



