

Built-in Oven

User manual

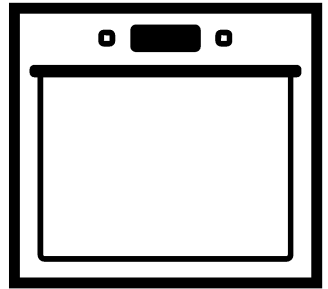

IMPORTANT

Installer should leave these instructions with appliance.

Consumer should read these instructions before using the appliance and should retain them for future reference.

BWOS24110SS

BWOS24110B

IMPORTANT SAFETY INSTRUCTIONS

READ AND SAVE THESE INSTRUCTIONS



WARNING: Read all safety instructions before using the product. If the information in this manual is not followed exactly, a fire or explosion may result causing property damage, personal injury or death.



IMPORTANT:

This appliance is intended for normal household use only. It is not approved for outdoor or other non-household uses (including sea or air-going vessels). See the Statement of Limited Warranty. If you have any questions, contact the manufacturer.

Do not repair or replace any part of the appliance unless specifically recommended in this manual. Refer all servicing to a factory authorized service center.

Explanation of symbols

Throughout this User Manual the following symbols are used:



Important information or useful hints about usage.



Warning for hazardous situations with regard to life and property.



Warning for electric shock.



Warning for risk of fire.



Warning for hot surfaces.

DANGER indicates a hazardous situation which, if not avoided, will result in death or serious injury.

WARNING indicates a hazardous situation which, if not avoided, could result in death or serious injury.

CAUTION indicates a hazardous situation which, if not avoided, could result in minor or moderate injury.

NOTICE is used to address practices not related to physical injury.

 **Please read these instructions before installation
or using your appliance!**

Dear Customer,

We would like you to obtain best performance with your product that has been manufactured in modern facilities and passed through strict quality control procedures.

Therefore, we advise you to read through this user manual carefully before using your product and keep it for future reference. If you hand over the product to someone else, deliver the user manual as well.

The user manual will help you use the product in a fast and safe way.



IMPORTANT:

Save these instructions for the local electrical inspectors use.



IMPORTANT:

This product can only be used in the rooms which incorporates a properly adjusted and functioning Carbon Monoxide sensor. Make sure the Carbon Monoxide sensor works properly and its maintenance done frequently. Carbon Monoxide sensor should be installed maximum 6.5 feet away from the product.

The instructions will help you to operate the appliance quickly and safely.

- Upon delivery, please check that the appliance is not damaged. If you note any transport damage, please contact your point of sale immediately and do not connect and operate the appliance!
- Before you connect and start using the appliance, please read this manual and all enclosed documents. Please note in particular the safety instructions.
- Keep all documents so that you can refer to the information again later on.
Please keep your receipt for any repairs which may be required under warranty.
- When you pass on the appliance to another person, please provide all documents with it including original date of purchasing. (The warranty does not convey if the unit is sold).
- If you should decide not to use this appliance any longer (or decide to substitute an older model), before disposing of it, it is recommended that it be made inoperative in an appropriate manner in accordance to health and environmental protection regulations, ensuring in particular that all potentially hazardous parts be made harmless, especially in relation to children who could play with old appliances.

TABLE OF CONTENTS

1 Safety Instructions - Read before use

6

Basic safety instructions	6
Safety for children	10
Safety when working with electricity	11
Intended use.....	11
Disposal	12
Packaging material.....	12
Future transportation.....	12

2 Installation

13

Before installation	13
Connection to the main supply	19

3 Preparation

21

Tips for saving energy	21
Initial use.....	21
Time setting.....	21
First cleaning of the appliance.....	21
Initial heating	22

4 How to operate the oven

23

General information on baking, roasting and broiling	23
How to operate the electric oven	23
Operating modes.....	24
Using the oven clock	25
Cooking times table.....	28
How to operate the broil.....	29

5 Maintenance and care

30

General information	30
Cleaning the control panel	30
Cleaning the oven	30
Removing the oven door	31
Replacing the oven lamp.....	31

6 General information

33

Overview.....	33
Technical specifications.....	34
Package contents.....	35

7 Troubleshooting



36

8 WARRANTY STATEMENT FOR BLOMBERG ELECTRIC AND GAS RANGES

37





1 Safety Instructions - Read before use

Basic safety instructions

- The manufacturer reserves its right to make changes in the technical specifications in order to improve the appliance quality without any prior notice. Figures included in this manual are for schematic purpose only and may not match exactly with your appliance. Values stated on the markings of the appliance or in other printed documents supplied with the appliance are obtained under laboratory conditions as per relevant standards. These values may vary according to the usage of the appliance and ambient conditions.
- This appliance is not intended for use by persons (including children) with reduced physical, sensory or mental capabilities, or lack of experience and knowledge, unless they have been given supervision or instruction concerning use of appliance by a person responsible for their safety.
- Children should be supervised to ensure that they do not play with the appliance.
- Proper installation - Be sure your appliance is properly installed and grounded by a qualified technician
- If the supply cord damaged, it must be replaced by a special cord or assembly available from the manufacturer or its service agent or similarly qualified persons.
- ** WARNING:** Never use your appliance for warming or heating the room.
- User servicing - Do not repair or replace any part of the appliance unless specifically recommended in the manual. All other servicing should be referred to a qualified technician.
- Wear proper apparel - loose-fitting or hanging garments should never be worn while using the appliance.
- Use care when opening door- let hot air or steam escape before removing or replacing food.
- ** CAUTION:** Placement of oven racks -always place oven racks in desired location while oven is cool. If rack must be moved while oven is hot, do not let potholder contact hot heating element in oven.
- ** CAUTION:** Use only dry potholders- moist or damp potholders on hot surfaces may

result in burns from steam. Do not let potholder touch hot heating elements.





Do not use a towel or other bulky clothes.

- Do not heat unopened food containers. Pressure could build up and the container could burst, causing an injury.
- Keep oven vent ducts unobstructed.
- Ensure that no flammable materials are adjacent to the appliance as the sides become hot during use.
- Do not place baking trays, dishes or aluminum foil directly onto the bottom of the oven. The heat accumulation might damage the bottom of the oven.
-  **CAUTION:** Do not use aluminum foil to line drip pans or anywhere in the oven, except as described in this manual. Foil can trap heat or melt, resulting in damage to the product and a shock or fire hazard.
-  **WARNING:** Keep all ventilation slots clear of obstructions.
- The manufacturer declines all liability for injury to persons or damage to property caused by incorrect or improper use of the appliance.
- Do not use the oven with front door glass removed or broken.
-  **WARNING:** Do not use water on grease fires. If there is a fire in the oven during baking, smother the fire by closing the oven door and turning the oven off or by using a multi-purpose dry chemical or foam-type fire extinguisher.
-  **WARNING:** Rear surface of the oven gets hot when it is in use. Electric connection should not touch the rear surface, otherwise the mains cable may get damaged. Do not trap the mains cable between the hot oven door and frame. Do not route the mains cable over the hot cooking section. Otherwise, cable insulation may melt and cause fire as a result of short circuit.
- Never wear loose-fitting or hanging garments while using the appliance. Be careful when reaching for items stored in cabinets over the oven. Flammable material could be ignited if brought in contact with hot surfaces or heating elements and may cause severe burns.
- Pulling out the rack to the stoplock is a convenience in lifting heavy foods. It is also a precaution against burns from





touching hot surfaces of the door or oven walls.

-  **WARNING:** Do not use the oven to dry newspapers. If overheated, they can catch on fire.
-  **WARNING:** Storage in or on Appliance- Flammable materials should not be stored in an oven or near surface units.
-  **WARNING:** Do not leave paper products, cooking utensils or food in the oven when not in use.
-  **WARNING:** After broiling, always take any broiler pan out of the oven and clean it. Leftover grease in a broiler pan can catch fire next time you use the pan.
- Check that all controls on the appliance are switched off after use.
-  **WARNING:** **"Do not touch heating elements or interior surfaces of oven** - Heating elements may be hot even though they are dark in color. Interior surfaces of an oven become hot enough to cause burns. During and after use, do not touch, or let clothing or other flammable materials contact heating elements or interior surfaces of oven until they have had sufficient time to cool. Other



surfaces of the appliance may become hot enough to cause burns - among these surfaces are oven vent openings and surfaces near these openings, interior surfaces of the oven cavity, oven doors, and window."

-  **WARNING:** Accessible parts may become hot during use. Young children should be kept away.
-  **CAUTION:** Do not use harsh abrasive cleaners or sharp metal scrapers to clean the oven door glass since they can scratch the surface, which may result in shattering of the glass.
-  **WARNING:** This appliance can be used by children aged from 8 years and above and persons with reduced physical, sensory or mental capabilities or lack of experience and knowledge if they have been given supervision or instruction concerning use of the appliance in a safe way and understand the hazards involved.
- Children shall not play with the appliance. Cleaning and user maintenance shall not be made by children without supervision.
-  **WARNING:** The appliance and its accessible parts become hot during use. Care should be

taken to avoid touching heating elements. Children less than 8 years of age shall be kept away unless continuously supervised.

-  **WARNING:** Only use the connection cable specified in the “Technical specifications”. If the supply cord damaged, it must be replaced by a special cord or assembly available from the manufacturer or its service agent or similarly qualified persons in order to avoid a hazard.
-  **WARNING:** During self-cleaning, surfaces may become hotter than with standard use. Keep children away.
-  **CAUTION:** Use care when opening door- let hot air or steam escape before removing or replacing food.
- Do not heat closed food containers and glass jars. Pressure that may build-up in the jar can cause it to burst.
-  **WARNING:** Food Poisoning Hazard: Do not let food sit in oven for more than 1 hour before or after cooking. Doing so can result in food poisoning or sickness.
-  **WARNING:** To avoid permanent damage to the oven bottom finish do not line the



oven bottom with any type of foil or liner.

-  **CAUTION:** If a wet sponge or cloth is used to wipe spills on a hot cooking area, be careful to avoid steam burn. Some cleaners can produce noxious fumes if applied to a hot surface. Utensil handles should be turned inward and not extend over adjacent surface units. To reduce the risk of burns, ignition of flammable materials, and spillage due to unintentional contact with the utensil, the handle of a utensil should be positioned so that it is turned inward, and does not extend over adjacent surface units.
-  **CAUTION:** Do not store or use flammable materials in an oven, including paper, plastic, pot holders, linens, wall coverings, curtains, drapes and gasoline or other flammable vapors and liquids.
- Never use when judgment or coordination is impaired by the use of alcohol and/or drugs.
- Do not operate the appliance if it is defective or shows any visible damage.
- Do not carry out any repairs or modifications on the appliance. However, you may remedy some

malfunctions; see Trouble-shooting.

- Be careful when using alcoholic drinks in your dishes. Alcohol evaporates in high temperatures and may cause fire since it will catch fire when it gets in contact with hot surfaces.
-  **WARNING:** Keep appliance area clear and free from combustible materials, gasoline, and other flammable vapors.
-  **WARNING:** Keep the oven free from grease buildup. Grease in the oven may ignite.
- Only authorized replacement parts may be used in performing service on the range. Replacement parts are available from factory authorized parts distributors. Contact the nearest parts distributor in your area.
-  **WARNING:** Use this appliance for its intended purpose as described in this owner's manual.
-  **CAUTION:** Always use heat-resistant gloves when putting or removing the dishes into/from your oven.
-  **CAUTION:** Always use Only Dry Potholders or heat-resistant gloves when putting or removing the dishes into/from your oven.

Do not let potholder touch hot heating elements.

-  **WARNING:** Avoid scratching or impacting glass doors, cook tops or control panels. Doing so may lead to glass breakage. Do not cook on a product with broken glass. Shock, fire or cuts may occur.
-  **IMPORTANT:** Call the authorized service for installation of the appliance to be used. After this procedure, guarantee period will be started.



Safety for children

- **WARNING:** Stepping, leaning or sitting on the door or drawers of this range can result in serious injuries and also cause damage to the range. Do not allow children to climb or play around the range. The weight of a child on an open door may cause the range to tip, resulting in serious burns or other injury.
- Accessible parts may be hot when the broil is in use. Young children should be kept away.
- Surface units may be hot even though they are dark in color. Areas near surface units may become hot enough to cause burns. During and after use, do not touch or let clothing or other flammable materials contact surface units until they have had

sufficient time to cool. Among these areas are (identification of areas) for example, the cook-top and surfaces facing the cook-top.

-  **WARNING:** Do not store items of interest to children in the cabinets above the range or on back guard of a range. Children climbing on the range to reach items could be seriously injured.
- The packaging materials will be dangerous for children. Keep the packaging materials away from children. Please dispose of all parts of the packaging according to environmental standards.
- Do not leave children alone - children should not be left alone or unattended in area where appliance is in use. They should never be allowed to sit or stand on any part of the appliance.

Safety when working with electricity

-  **WARNING:** Before installing, turn power OFF at the service panel. Lock service panel to prevent power from being turned ON accidentally.
-  **WARNING:** Personal injury or death from electrical shock may occur if the range is not installed by a qualified installer or electrician.

- Any additions, changes or conversions required in order for this appliance to satisfactorily meet the application needs must be made by a qualified technician.
- Before performing any service, unplug the range or disconnect the power supply at the household distribution panel by removing the fuse or switching off the circuit breaker.
- Any work on electric equipment and systems may only be carried out by authorized qualified persons.
- In case of any damage, switch off the appliance and disconnect it from the main supply by removing the fuse or switching off the circuit breaker.
- Ensure that the fuse rating is correct.
- Do not operate the appliance barefooted.
- Never touch the appliance with wet hands or feet.
- Do not soak removable heating elements. Heating elements should never be immersed in water.

Intended use

- This product is designed for domestic cooking purposes only. It is not designed for any other uses such as room heating or

drying towels and dish cloths. Commercial use will void the guarantee.

- All openings in the wall behind the appliance and in the floor under the appliance shall be sealed.
- This appliance is not intended to use at mobile homes, recreational vehicles.
-  **WARNING:** Do not obstruct the flow of ventilation air.
- The manufacturer shall not be held liable for any damage caused by improper use or handling errors.
- The appliance can be used for defrosting, baking, roasting and broiling food.

Disposal

Packaging material



DANGER:
Risk of suffocation by the packaging materials!
Packing elements (i.e. plastic bags, polystyrene foam, nails, packing straps, etc.) should not be left around within easy reach of children, as these may cause serious injuries.

The packaging material and transport locks are made from materials that are not harmful to the environment. Please dispose of all parts of the

packaging according to environmental standards. This is beneficial to the environment.



CAUTION:
If product will be given to someone for personal use or given to someone for second hand use, User manual, product labels, other related documents, mounting parts etc. should be given with product.

Future transportation

Do not carry out cleaning or maintenance operations on the appliance without having previously disconnected it from the electric power supply.



NOTICE:
Do not place other items on the top of the appliance. The appliance must be transported upright.

Store the appliance's original box and transport the appliance in its original carton. Follow the guidance marks that are printed on the carton.



IMPORTANT:
Verify the general appearance of your equipment by identifying possible damage during the transportation.

To prevent the wire shelf and tray inside the oven from damaging the oven door, place a strip of cardboard onto the inside of the oven door that lines up with the position of the trays. Tape the oven door to the side walls.

If you do not have the original carton

Pack the appliance in bubble wrap or thick cardboard and tape it securely in order to prevent damage during transportation.

2 Installation



IMPORTANT:

The product should only be installed by suitably qualified electricians.

- Preparation of location and electrical installation for the product is under customer's responsibility.
- The product must be installed in accordance with all local electrical regulations.
- Prior to installation, visually check if the product has any defects on it. If so, do not have it installed.
- Damaged products cause risks for your safety.

Before installation

The appliance is intended for installation in commercially available kitchen cabinets. A safety distance must be left between the appliance and the kitchen walls and furniture. See figure (values in mm).

- Surfaces, synthetic laminates and adhesives used must be heat resistant.
- Kitchen cabinets must be set level and fixed.
- If there is a drawer beneath the oven, a shelf must be installed between oven and drawer.
- The following installation drawings are representational and may not match exactly with your appliance
- Product guarantee will be valid after proper installation. Manufacturer will not be responsible any hazard or damage of improper installation or usage.
- Don't pull the oven on the floor during transportation in order to avoid damages on the floor surface. Always carry your product by using two or more people.
- Remove all shipping materials inside or outside of the oven.
- Remove all equipments inside of the oven including the printed documents.



Important notes to the consumer

Keep this manual for future reference.

- As when using any range generating heat, there are certain safety precautions you should follow. These are listed in the front of this manual. Read and follow carefully.
- Be sure your range is installed and grounded properly by a qualified installer or service technician.



Important notes to the installer

Read manual before installing the range.

Observe all governing codes and ordinances.

Be sure to leave these instructions with the consumer.

Be sure your range is installed and grounded properly by a qualified installer or service technician.



IMPORTANT:

Before installing the range in an area covered with linoleum or any other synthetic floor covering, make sure the floor covering can withstand heat at least 90°F (32.2°C) above room temperature without shrinking, warping or discoloring.

Installation Conditions

- All dimensions given in this manual are in inches and millimeters.
- The oven has dimensions given in Figure B.
- The product should be installed to the cabinets with the dimensions specified for different types of locations.
- The first step of the installation is to check the dimensions of your existing cut out. For new furniture orders, these dimensions should be considered.
- All cabinet works, if necessary should be completed before installation and all remains of the work should be cleaned before installation.
- Kitchen cabinet should be fixed and level so that the fix oven can't tilt.
- The board of the cabinet on which the oven to placed should withstand 220 lbs (100 kg) or more.
- If there is a drawer beneath the oven, a shelf must be installed between the oven and drawer.

Installation Under a Countertop

- The cabinet should have the dimensions in Figure A.
- Base plate dimension must $\frac{3}{4}$ " (19 mm).
- Junction box may be located in adjacent cabinet.

A

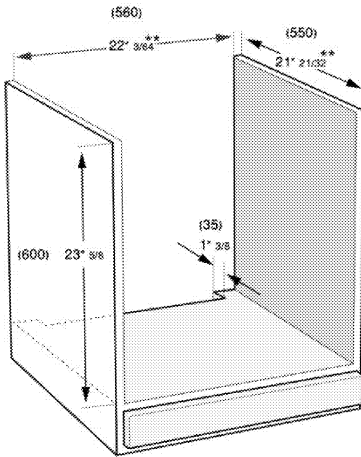

Installation in a High Cupboard

- The cabinet should have the dimensions in Figure C.
- Junction box may be located in adjacent cabinet.

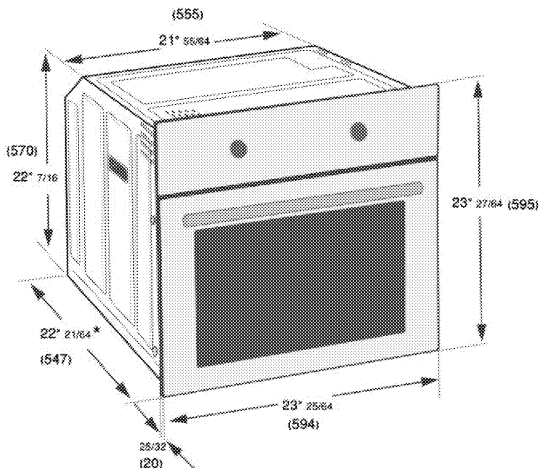
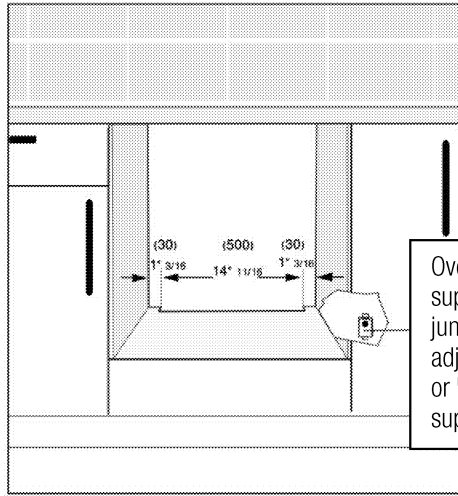

B

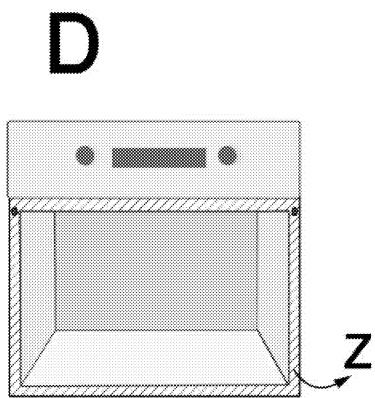
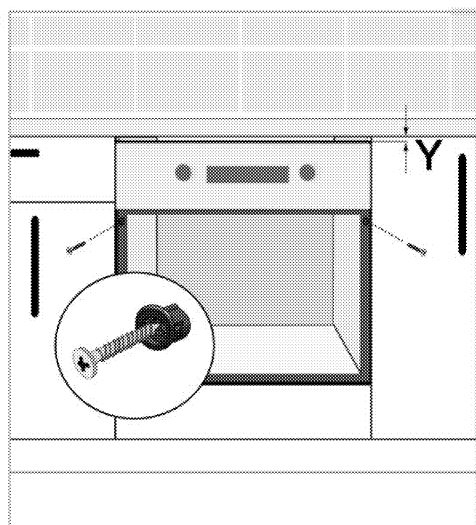
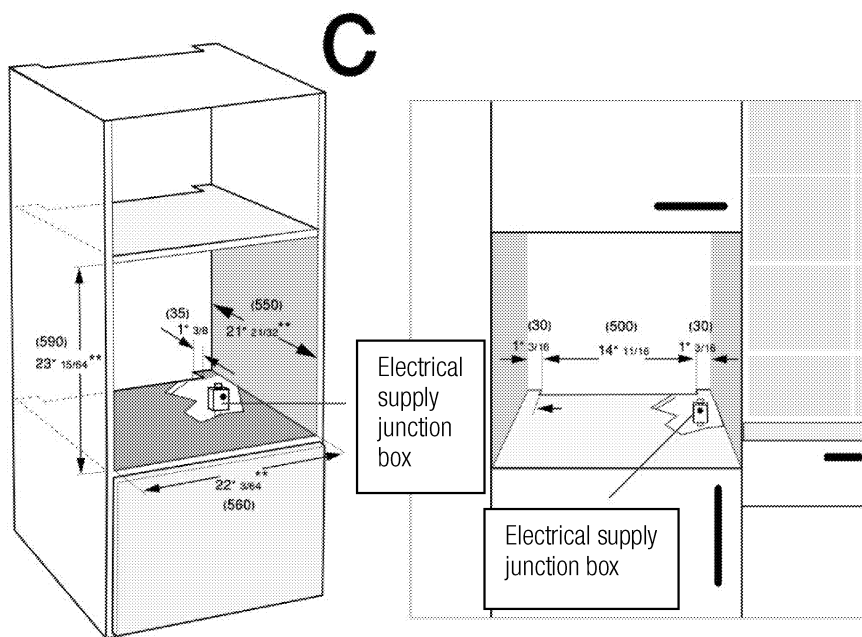

Flush Installation in a High Cupboard

- The cabinet should have the dimensions in Figure E.

- Junction box may be located in adjacent cabinet.
- For flush installation you need to have two reveal cleats fixed.

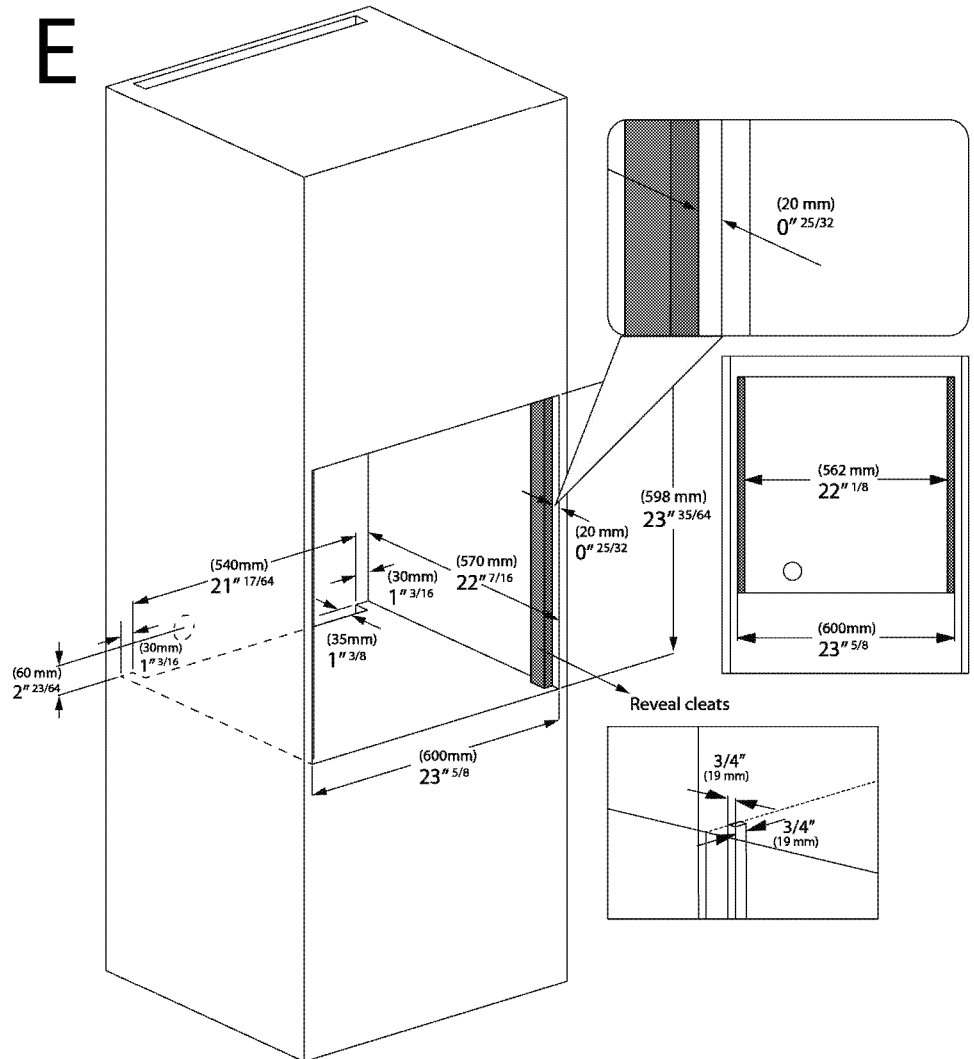

Positioning and Fixing the Oven

- Use safety gloves before carry the oven.
- Put the oven into the cabinet by two or more people.
- Don't carry or lift the oven from its handle or front panel.

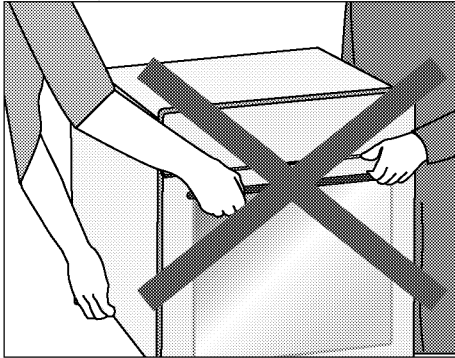

- Carry the oven like in the figures below.

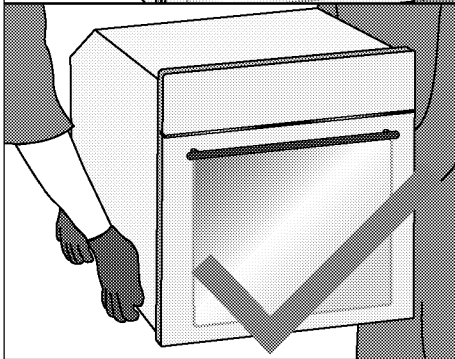
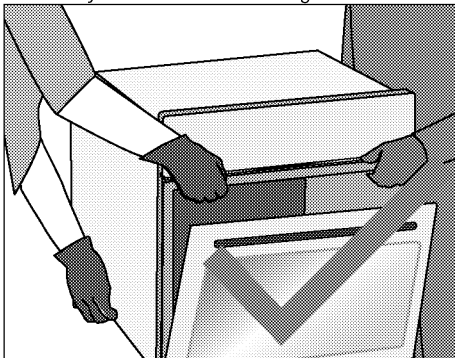

- Push the oven into the cabinet from the seal area (Z). Don't push against the control panel or edges.

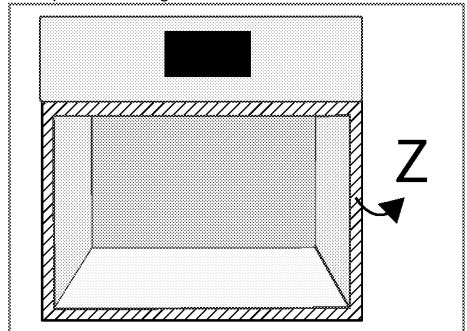

- Be sure that oven frame and cabinet front frame overlapped perfectly.
- The supply cord must not be clamped, bent, or squeezed during positioning the oven into the cabinet. If there is a damage on the supply cord, it must be replaced by a qualified electrician with a new supply cord with the technical properties listed in the user manual.
- Fix the oven to the cabinet using the screws provided. Screws should be inserted through installation mounted on the side frames of the oven (see Figure D). Do not over tighten the screws.
- After installation, check the screws are securely tightened and the product can't be moved. If the oven is not installed and tightened properly, there is a risk of tip over.

Final Check

- Turn on the power source after installing the oven.
- Refer to the user manual for first usage of the oven.
- Check functions.

Installation and connection



IMPORTANT: **Material damage!**

The door and/or handle must not be used for lifting or moving the appliance.

If the appliance has wire handles, push the handles, back into the side walls after moving the appliances.

- Carry the appliance with at least two persons.
- For installation the appliance must be connected in accordance with all local electrical and/or gas regulations.



DANGER **Electrical shock hazard!**

Do not use an adapter plug, an extension cord, or remove grounding prong from electrical power cord, have a qualified electrician install an outlet near the appliance. Failure to follow this warning can cause serious injury, fire or death.

- Contact a qualified installer or contractor to determine the proper method for drilling holes through the wall or floor material (such as ceramic tile, hardwood, etc.)
- Do not slide the unit across an unprotected floor.
- Failure to follow these instructions may result in damage to wall or floor coverings.
- The California Safe Drinking water and Toxic Enforcement Act requires the Governor of California to publish a list of substances known to the State of California to cause cancer, birth defects, or other reproductive harm, and requires businesses to warn of potential exposure to such substances.



IMPORTANT:

This product contains a chemical known to the state of California to cause cancer, birth defects, or other reproductive harm.

This appliance can cause low-level exposure to some of the substances listed, including benzene, formaldehyde, car-bon monoxide, and toluene.

Installation instructions

- Electrical connections:
- Attention Installer

- All electric wall ovens must be hard wired (Direct wired) into an approved junction box. A plug and receptable is not permitted on these product. Do not shorten the flexible conduit. The conduit strain relief clamp must be securely attached to the junction box and the flexible conduit must be securely attached to the clamp. If the flexible conduit will not fit within the clamp, do not install the oven the oven until a clamp of the proper size is obtained.

Electrical Connection



IMPORTANT:

Save for the local electrical inspector's use.



IMPORTANT:

Any work on electric equipment and systems may only be carried out by authorized qualified persons.

- It is important that the place of installation has an adequate electrical system. Before installing the oven, it should be controlled by a qualified electrician and approved that the addition of the oven will not overload the branch circuit on which it is to be installed. The mains supply data should correspond to the data specified on the type plated. Type plate can be reached by opening the front door of the oven.
- The unit should be installed and connected in accordance with national and local regulations.
- The cable for further replacements should correspond to the specifications listed in the user manual.
- Turn off the power source before installing the oven. The product should not be connected to the mains before the installation completed.

Connection to the main supply



IMPORTANT:

Electrical installation should comply with national and local codes.



IMPORTANT:

This appliance must be grounded!



WARNING

Avoid fire hazard or electrical shock. Do not use an adapter plug, an extension cord, or remove grounding prong from electrical power cord, have a qualified electrician install an outlet near the appliance. Failure to follow this warning can cause serious injury, fire or death.



WARNING: Power supply!

The main power supply lead must not be clamped, bent or trapped or come into contact with hot parts of the appliance. If the main power supply is damaged, it must be replaced by a qualified electrician.

Be sure your appliance is properly installed and grounded by a qualified technician. Ask your dealer to recommend a qualified technician or an authorized repair service.

This appliance is manufactured with a green GROUND wire connected to the oven chassis. After making sure that the power has been turned off, connect the flexible conduit from the oven to the junction box using a U.L. listed conduit connector. Figures A and B and the instructions provided below present the most common way of connecting the ovens. Your local codes and ordinances, of course, take precedence over these. Complete electrical connections according to local codes and ordinances.



WARNING

Risk of Electric Shock or Fire. Grounding through the neutral conductor is prohibited for new branch circuit installations (1996 NEC), mobile homes, and recreational vehicles, or in an area where local codes prohibit grounding through the neutral conductor.

For installations where grounding through the neutral conductor is prohibited:

- Disconnect the ground from the neutral at free end of conduit;
- Use grounding terminal of lead to ground unit; and
- Connect neutral terminal or lead to branch circuit neutral in usual manner.

Wire branch circuit (for US only)

Figure A

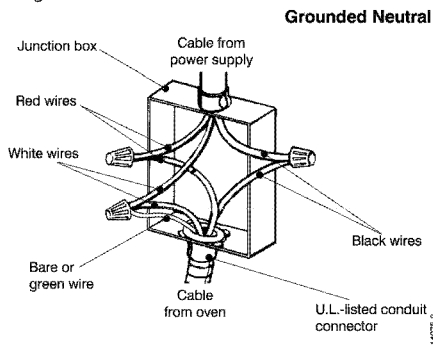

Refer to Figure A, where local codes allow the connection of GROUND wire from the oven to the branch circuit NEUTRAL wire (gray or white colored wire):

- If local codes permit, connect the green GROUND wire from the oven and white wire from the oven to the branch circuit NEUTRAL wire (gray or white colored wire).
- Connect the red and black leads from the oven to the corresponding leads in the junction box.

Wire branch circuit (for US and Canada)

Figure B

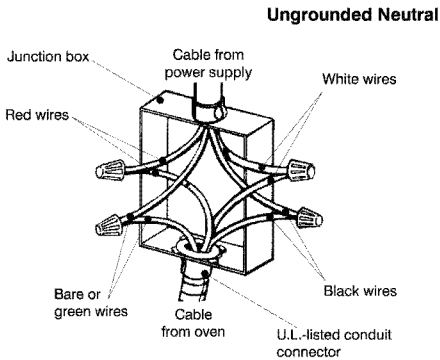

Refer to Figure B:

- Disconnect ground from neutral at free end of conduit.
- Connect the green GROUND wire from the oven to the GROUND wire in the junction box (bare or green colored wire).
- Connect the red and black leads from the oven to the corresponding leads in the junction box.
- Connect the white wire from the oven to the NEUTRAL (gray or white) wire in the junction box.

Electrical requirements

This appliance must be supplied with the proper voltage and frequency and connected to an individual, properly grounded branch circuit, protected by a circuit breaker or fuse.

See the rating plate located on the side trim to determine the rating of the product. Use the chart below to determine to minimum recommended dedecated circuit protection.

kW Rating 240 V	Recommended circuit size (Dedicated)
<4,8 kW	20 Amp

For installations where grounding through the neutral conductor is prohibited.

The main supply data must correspond to the data specified on the rating plate of the

appliance. The rating plate is either seen when the door or the lower cover is opened or it is located at the rear wall of the appliance depending on the appliance type.

Rating Plate Location

Open the front door to see the rating label.

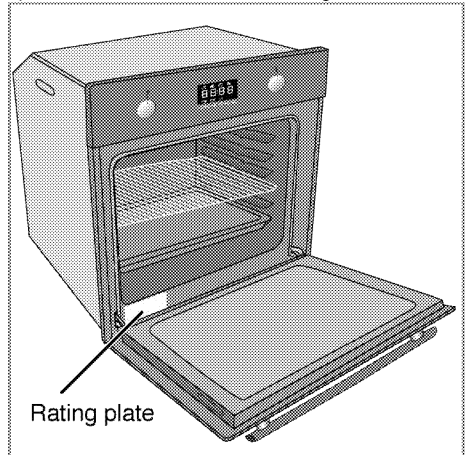

For equipment with a cooling fan

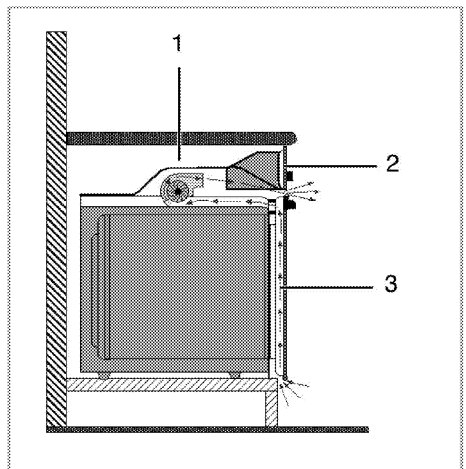

- 1 Fan
- 2 Control panel
- 3 Door

The Built-in cooling fan cools both the built-in cabinet and the front of the appliance.



Cooling fan continues to run for up to 20-30 minutes (approx.) even after the oven is turned off.

3 Preparation

Tips for saving energy

The following information will help you to use your appliance in an ecological way, and to save energy:

- Use dark colored or enamel coated cookware in the oven since the heat transmission will be better.
- While cooking your meals, perform a preheating operation if it is advised in the user manual or cooking instructions.
- During cooking, do not open the oven door frequently.
- Try to cook more than one type of meal with in the oven at the same time (You can cook two different meals at the same time by locating cooking bowls on the same shelf). It will be suitable to cook more than one meal after each other. The oven will already be hot.
- Defrost frozen meals before cooking them.
- You can save energy by switching off your oven a few minutes before the end of the cooking time. (The oven door should not be opened).

Initial use

Time setting



While making any adjustment, related symbols will flash on the display.

Press **+**/**-** keys to set the time of the day after the oven is energized for the first time.



For touch control models, touch first and then use **+** / **-** to set the time of the day.

Confirm the setting by touching symbol and wait for 4 seconds without touching any keys to confirm.

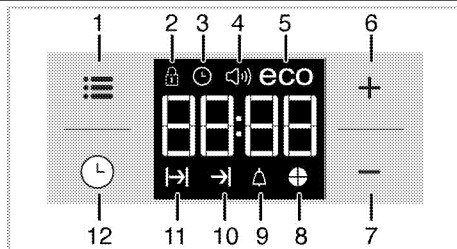

- 1 Adjustment key
- 2 Keylock symbol
- 3 Clock symbol
- 4 Alarm volume symbol
- 5 Eco mode symbol
- 6 Plus key
- 7 Minus key
- 8 Time pie symbol
- 9 Alarm symbol
- 10 End of Cooking Time symbol
- 11 Cooking Time symbol
- 12 Program key



If the initial time is not set, clock will run starting from **12:00** and symbol will be displayed. The symbol will disappear once the time is set.



Current time settings are canceled in case of power failure. It needs to be readjusted.

First cleaning of the appliance



When removing appliance for cleaning and/ or service;

Disconnect AC power supply.
Carefully remove the range by pulling outward.
Range is heavy, use care in handling.

 The surface might get damaged by some detergents or cleaning materials.
Do not use aggressive detergents, cleaning powders/creams or any sharp objects during cleaning.
Do not use harsh abrasive cleaners or sharp metal scrapers to clean the oven door glass since they can scratch the surface, which may result in shattering of the glass.

1. Remove all packaging materials.
2. Wipe the surfaces of the appliance with a damp cloth or sponge and dry with a cloth.

Initial heating

 **IMPORTANT:** Smoke and smell may emit for a couple of hours during the initial operation. This is quite normal. Ensure that the room is well ventilated to remove the smoke and smell. Avoid directly inhaling the smoke and the smell that emits.

Heat up the product for about 30 minutes and then switch it off. Thus, any production residues or layers will be burnt off and removed.

 **WARNING**
Hot surfaces cause burns!
Product may be hot when it is in use. Never touch the hot burners, inner sections of the oven, heaters and etc. Keep children away.
Always use heat resistant oven gloves when putting in or removing dishes into/from the hot oven.

Electric oven

1. Take all baking trays and racks from the oven.
2. Close the oven door.
3. Select top and bottom heat with the function knob.
4. Select the highest temperature with the thermostat knob; see How to use the electric oven.
5. Heat approximately 30 minutes.
6. Switch off oven.

Broil

1. Take all baking trays and wire shelf from the oven.
2. Close oven door.
3. Select highest power of the broil.
3. Heat approximately 30 minutes.
4. Switch off broil.

 Smoke and smell may emit for a couple of hours during the initial operation. This is quite normal. Ensure that the room is well ventilated to remove the smoke and smell. Avoid directly inhaling the smoke and the smell that emits.

4 How to operate the oven

General information on baking, roasting and broiling



WARNING

Hot surfaces cause burns!
Product may be hot when it is in use. Never touch the hot burners, inner sections of the oven, heaters and etc. Keep children away. Always use heat resistant oven gloves when putting in or removing dishes into/from the hot oven.



DANGER:

Be careful when opening the oven door as steam may escape.
Exiting steam can scald your hands, face and/or eyes.

Tips for baking

- Use non-sticky coated appropriate metal plates or aluminum vessels or heat-resistant silicone moulds.
- Make best use of the space on the rack.
- Place the baking mould in the middle of the shelf.
- Select the correct rack position before turning the oven or Broil on. Do not change the rack position when the oven is hot.
- Always place oven racks in desired location while oven is cool. If rack must be moved while oven is hot, do not let potholder contact hot heating element in oven.
- Keep the oven door closed.

Tips for roasting

- Seasoning with lemon juice and black pepper will improve the cooking performance when cooking a whole chicken, turkey or a large piece of meat.
- Meat with bones takes about 15 to 30 minutes longer before it is cooked than a roast of the same size without bones.
- You should calculate about 4 to 5 minutes cooking time per centimeter height of the meat.
- Let meat rest in the oven for about 10 minutes after the cooking time. The juice is better distributed all over the roast and does not run out when the meat is cut.

- Fish in a fire-resistant dish should be placed on the rack at the medium or lower level.

Tips for broiling

Broiling is ideal for cooking meat, fish and poultry and will achieve a nice brown surface without it drying out to much. Flat pieces, meat skewers and sausages are particularly suited for broiling as are vegetables with a high water content such as tomatoes and onions.

- Distribute the pieces to be broiled on the wire shelf.
- If the broiling is on the wire shelf, locate a dripping pan under it in order to collect the fat.
- Add some water in dripping pan for easy cleaning.



Fire danger due to food which is unsuitable for grilling!

Only use food for grilling which is suitable for intensive grilling heat.
Do not place the food too far in the back of the grill. This is the hottest area and fat food may catch fire.



Fan only runs if necessary for improving performance of cooking and saving the energy of the oven.

Tips for cooking vegetables

1. If the vegetable dish runs out of juice and gets to dry,
» Since using a lid during cooking will keep the juice of the dish in the pan, cook your vegetable dishes in a pan with a lid instead of a tray.
2. If a vegetable dish does not get cooked,
» Boil the vegetables beforehand or prepare them like canned food and put in the oven.

How to operate the electric oven



Food Poisoning Hazard

Do not let food sit in oven more than one hour before or after cooking.
Doing so can result in food poisoning or sickness.



WARNING

Never cover any slots, holes or passages in the oven bottom or cover an entire rack with materials such as aluminium foil. Doing so blocks airflow through the oven and may cause carbon monoxide poisoning. Aluminium foil linings may also trap heat, causing a fire hazard.

Select temperature and operating mode

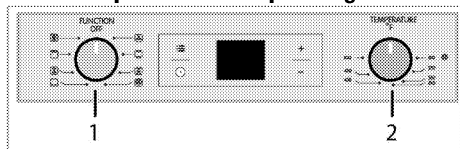

- 1 Function knob
- 2 Thermostat knob

The operating modes of the electric oven are selected with the function knob. The temperature is adjusted with the thermostat knob.

All oven functions are turned off by turning the relevant knob to off (upper) position.

1. Set thermostat knob to the desired temperature.
 2. Set function knob to the required operating mode.
- » The oven heats up to the adjusted temperature and maintains it. During heating, temperature lamp stays on.

Switch off electric oven

Turn function knob and thermostat knob to off position (top).

Rack positions (For models with wire shelf)

It is important to place the wire shelf onto the side rack correctly. Wire shelf must be inserted between the side racks as illustrated in the figure. Do not let the wire shelf stand against the rear wall of the oven. Slide your wire shelf to the front section of the rack and settle it with the help of the door in order to obtain a good broil performance.

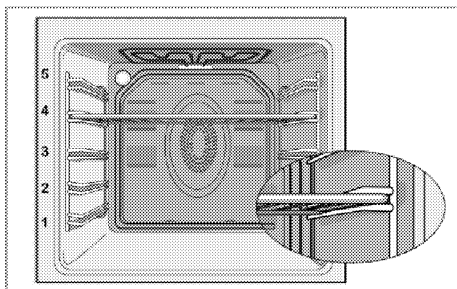

Operating modes

The order of operating modes shown here may be different from the arrangement on your product.

Top and bottom heating



Top and bottom heating are in operation. Food is heated simultaneously from the top and bottom. For example, it is suitable for cakes, pastries, or cakes and casseroles in baking moulds. Cook with one tray only.

Bottom heating



Only bottom heating is in operation. It is suitable for pizza and for subsequent browning of food from the bottom.

Fan supported bottom/top heating



Top heating, bottom heating plus fan (in the rear wall) are in operation. Hot air is evenly distributed throughout the oven rapidly by means of the fan. Cook with one tray only.

Operating with fan



The oven is not heated. Only the fan (in the rear wall) is in operation. Suitable for thawing frozen granular food slowly at room temperature and cooling down the cooked food.

Fan Heating



Warm air heated by the rear heater is evenly distributed throughout the oven rapidly by means of the fan. It is suitable for cooking your meals in different rack levels and preheating is not required in most cases. Suitable for cooking with multi trays.

"3D" function



Top heating, bottom heating and fan assisted heating (in the rear wall) are in operation. Food is cooked evenly and quickly all around. Cook with one tray only.

Broil



Large broil at the ceiling of the oven is in operation. It is suitable for broiling large amount of meat.

- Put big or medium-sized portions in correct rack position under the broil heater for broiling.
- Set the temperature to maximum level.
- Turn the food after half of the broiling time.

Broil with convection air



Broiling effect is not as strong as in Full Broil

- Put small or medium-sized portions in correct shelf position under the broil heater for broiling.
- Set the desired temperature.
- Turn the food after half of the broiling time.

Using the oven clock

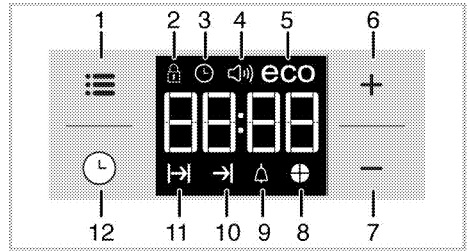

- 1 Adjustment key
- 2 Keylock symbol
- 3 Clock symbol
- 4 Alarm volume symbol
- 5 Eco mode symbol
- 6 Plus key
- 7 Minus key
- 8 Time pie symbol
- 9 Alarm symbol
- 10 End of Cooking Time symbol
- 11 Cooking Time symbol
- 12 Program key

	Maximum time that can be set for end of cooking is 5 hours 59 minutes. Program will be cancelled in case of power failure. You must reprogram the oven.
	While making any setting, related symbols will flash on the display. You must wait for a short time for the settings to take effect.
	If no cooking setting is made, time of the day cannot be set.
	Remaining time will be displayed if cooking time is set when the cooking starts.

Cooking by setting the cooking time;

You can set the oven so that it will stop at the end of the specified time by setting the cooking time on the timer.





1. Select the function for cooking.
2. Touch until symbol appears on display for cooking time.
3. Set the cooking time with **+** / **-** keys.
» » After the cooking time is set, symbol and the time slice will appear on display continuously.



4. Place the dish into the oven and set the temperature with temperature knob. Cooking will start.

» Cooking time starts to count down on display when cooking starts and all parts of time slice symbol is lit. The set cooking time is divided into 4 equal parts and when the time of each parts ends, the symbol of that parts turns off. So you can understand the ratio of remaining cooking time to total cooking time easily.

Setting the the end of cooking time to a later time;

After setting the cooking time on the timer, you can set the end of cooking time to a later time.

1. Select the function for cooking.
2. Touch  until  symbol appears on display for cooking time.
3. Set the cooking time with **+** / **-** keys.
» Once the Cooking Time is set,  symbol will appear on display continuously.
4. Touch  until  symbol appears on display for the end of cooking time.
5. Press **+** / **-** keys to set the end of cooking time.

» After the cooking time is set,  symbol plus  symbol and the time slice will appear on display continuously. Once the cooking starts,  symbol disappears.

6. Place the dish into the oven and set the temperature with temperature knob. Cooking will start.

» **Oven timer calculates the startup time by deducting the cooking time from the end of cooking time you have set.** Selected operating mode is activated when the startup time of cooking has come and the oven is heated up to the set temperature. It maintains this temperature until the end of cooking time.



» Cooking time starts to count down on display when cooking starts and all parts of time slice symbol is lit. The set cooking time is divided into 4 equal parts and when the time of each parts ends, the symbol of that parts turns off. So you can understand the ratio of remaining cooking time to total cooking time easily.

7. After the cooking process is completed, "End" appears on the displayed and the timer gives an audio warning.
8. Audio warning sounds for 2 minutes. To stop the audio warning, just press any key. Audio warning will be silenced and current time will be displayed.

 If you press any key at the end of the audio warning, the oven will restart operating. Turn the temperature knob and function knob to "0" (off) position to switch off the oven in order to prevent re-operation of the oven at the end of warning.

Activating the keylock

You can prevent oven from being intervened with by activating the key lock function.

1. Touch  until  symbol appears on display.
» "OFF" will appear on the display.
2. Press **+** to activate the key lock.
» Once the key lock is activated, "On" appears on the display and the  symbol remains lit.

 Oven keys are not functional when the key lock is activated. Key lock will not be cancelled in case of power failure.

To deactivate the keylock

1. Touch  until  symbol appears on display.
» "On" will appear on the display.
2. Disable the key lock by pressing the **-** key.
» "OFF" will be displayed once the keylock is deactivated.

Setting the alarm clock

You can use the timer of the product for any warning or reminder apart from the cooking program.



The alarm clock has no influence on the functions of the oven. It is only used as a warning. For example, this is useful when you want to turn food in the oven at a certain point of time. Timer will give an audio warning at the end of the set time.

1. Touch  until  symbol appears on display.

 Maximum alarm time can be 23 hours and 59 minutes.

2. Set the alarm duration by using **+** / **-** keys.



 Function keys for alarm tone, time of day, display brightness and temperature keys should be at 0 (OFF) position.

- »  symbol will remain lit and the alarm time will appear on the display once the alarm time is set.
- 3. At the end of the alarm time,  symbol starts flashing and the audio warning is heard.

Turning off the alarm





1. Audio warning sounds for 2 minutes. To stop the audio warning, just press any key.
- » Audio warning will be silenced and current time will be displayed.

Cancelling the alarm;

1. Touch  until  symbol appears on display in order to cancel the alarm.
2. Press and hold  key until "00:00" is displayed.





 Alarm time will be displayed. If the alarm time and cooking time are set concurrently, shortest time will be displayed.

Changing alarm tone

1. Touch  until  symbol appears on display.
2. Adjust the desired alarm tone with  /  keys.
3. The tone you have set will be activated in a short time.
- » Selected alarm tone will appear as "b-01", "b-02" or "b-03" on the display.

Changing the time of the day

To change the time of the day you have previously set:



1. Touch  until  symbol appears on display.
2. Set the time of the day with  /  keys.

3. The time you have set will be activated in a short time.



Economy mode

You can save energy with economy mode while cooking by setting cooking time in the oven. This mode completes the cooking with the inner temperature of the oven by switching off the heaters before the end of cooking time.



Setting the economy mode

1. Touch  symbol until **eco** symbol appears on display.
- » "OFF" will appear on the display.
2. Enable economy mode by touching  key.
- » Once the economy mode is activated, "On" appears on the display and the eco symbol remains lit.

Disabling economy mode

1. Touch  symbol until **eco** symbol appears on display.
- » "On" will appear on the display.
2. Disable economy mode by touching  key.
- » "Off" will be displayed once the eco mode is deactivated.

Setting the screen brightness

1. Touch  until **d-01** or **d-02** or **d-03** appears on display for display brightness.
2. Set the desired brightness with  /  keys.
- » The time you have set will be activated in a short time.

Cooking times table



1st rack of the oven is the **bottom** rack.



Maximum load capacity of oven tray: 4 kg (8.8 lb).



The timings in this chart are meant as a guide. Timings may vary due to temperature of food, thickness, type and your own preference of cooking.

Baking and roasting

Dish	Cooking level number	Operating Mode (see p.21)	Rack position	Temperature (°F)	Cooking time (approx. in min.)
Cakes in tray*	One level		4	350	25 ... 30
Cakes in mould*	One level		2	355	40 ... 50
Cakes in cooking paper*	One level		3	350	25 ... 30
	2 levels		1 - 5	350	30 ... 40
	3 levels		1 - 3 - 5	360	45 ... 55
Sponge cake*	One level		3	390	5 ... 10
	2 levels		1 - 5	350	20 ... 30
Cookies*	One level		3	350	25 ... 30
	2 levels		1 - 5	350 ... 375	30 ... 40
	3 levels		1 - 3 - 5	350	35 ... 45
Dough pastry*	One level		2	390	30 ... 40
	2 levels		1 - 5	390	45 ... 55
	3 levels		1 - 3 - 5	390	55 ... 65
Filled savory pastry*	One level		2	390	25 ... 35
	2 levels		1 - 5	390	35 ... 45
	3 levels		1 - 3 - 5	375	45 ... 55
Leaven*	One level		2	390	35 ... 45
	2 levels		1 - 3	375	35 ... 45
Lasagna*	One level		2 - 3	390	30 ... 40
Pizza*	One level		2	390 ... 430	15 ... 20
Beef steak (whole) / Roast	One level		3	25 min. max, then 355 ... 375	100 ... 120
Leg of Lamb (casseroles)	One level		3	25 min. max, then 355 ... 375	70 ... 90
Roasted chicken	One level		3	15 min. max, then 355 ... 375	55 ... 65
	One level		2	15 min. max, then 355 ... 375	55 ... 65
Turkey (5.5 kg)	One level		2	25 min. max, then 355 ... 375	150 ... 210
	One level		2	25 min. max, then 355 ... 375	150 ... 210
Fish	One level		2	390	20 ... 30
	One level		3	390	20 ... 30

When cooking with 2 trays at the same time, place the deeper tray on the upper rack and the other one on the lower rack.
 * It is suggested to perform preheating for all foods.

(**) In a cooking that requires preheating, preheat at the beginning of cooking until the thermostat lamp turns off.

Tips for baking cake

- If the cake is too dry, increase the temperature by 50°F (10°C) and decrease the cooking time.
- If the cake is wet, use less liquid or lower the temperature by 50°F (10°C).
- If the cake is too dark on top, place it on a lower rack, lower the temperature and increase the cooking time.
- If cooked well on the inside but sticky on the outside, use less liquid, lower the temperature and increase the cooking time.

Tips for baking pastry

- If the pastry is too dry, increase the temperature by 50°F (10°C) and decrease the cooking time. Dampen the layers of dough with a sauce composed of milk, oil, egg and yoghurt.
- If the pastry takes too long to bake, pay care that the thickness of the pastry you have prepared does not exceed the depth of the tray.
- If the upper side of the pastry gets browned, but the lower part is not cooked, make sure that the amount of sauce you have used for the pastry is not too much at the bottom of the pastry. Try to scatter the sauce equally between the dough layers and on the top of pastry for an even browning.



Cook the pastry in accordance with the mode and temperature given in the cooking table. If the bottom part is still not browned enough, place it on one lower rack next time.

Tips for cooking vegetables

- If the vegetable dish runs out of juice and gets too dry, cook it in a pan with a lid instead of a tray. Closed vessels will preserve the juice of the dish.
- If a vegetable dish does not get cooked, boil the vegetables beforehand or prepare them like canned food and put in the oven.

How to operate the broil



Before using the oven the clock time must be set. If the clock time is not set, the main oven will not work.



WARNING

Hot surfaces may cause burns! Keep children away from the product.

Close oven door during broiling.

Switching on Broil

1. Set the function knob onto the broil symbol.
 2. Set broil temperature.
 3. Preheat for approximately 5 minutes, if it is necessary.
- » The thermostat lamp is switched on.

Switch off broil

1. Turn the function and thermostat knobs to off (upper) position.

Food	Rack position	Broiling time (approx.)
Fish	4..5	20..25 min. *
Sliced chicken	4..5	25..35 min.
Lamb chops	4..5	20..25 min.
Roast beef	4..5	25..30 min. *
Veal chops	4..5	25..30 min. *
Toast bread	4	1..2 min.
* depending on thickness		

5 Maintenance and care

General information

Service life of the product will extend and the possibility of problems will decrease if the product is cleaned at regular intervals.



DANGER:
Risk of electric shock!

Switch off the electricity before cleaning appliance to avoid an electric shock.



DANGER:
Hot surfaces may cause burns!

Allow the appliance to cool down before you clean it.



IMPORTANT:

The surface might get damaged by some detergents or cleaning materials.
Do not use aggressive detergents, cleaning powder/cream or any sharp objects. Do not use aggressive detergents, cleaning powder/cream or any sharp objects.

- Clean the appliance thoroughly after each use; in this way it will be possible to remove cooking residues more easily, thus avoiding these from burning the next time the appliance is used.



IMPORTANT:

No special cleaning agents are required for cleaning the appliance. It is recommended to use warm water with washing liquid, a soft cloth or sponge and use a dry cloth for drying.

- **Do not use any abrasive cleaning materials!**



The surface might get damaged by some detergents or cleaning materials.
Do not use aggressive detergents, cleaning powders/creams or any sharp objects during cleaning.
Do not use harsh abrasive cleaners or sharp metal scrapers to clean the oven door glass since they can scratch the surface, which may result in shattering of the glass.



WARNING:

Do not use steam cleaners to clean the appliance as this may cause an electric shock.

Cleaning the control panel

Clean the control panel and knobs with a damp cloth and wipe them dry.



IMPORTANT:

Damage of the control panel!
Do not remove the control knobs for control panel cleaning.

Cleaning the oven

No oven cleaner or any other special cleaning agent is required for cleaning the oven. It is recommended to wipe the oven with a damp cloth while it is still warm.

Do not allow fat or oils to build up in the oven base, or oven accessories.

To clean the side wall

1. Remove the front section of the side rack by pulling it in the opposite direction of the side wall.
2. Remove the side rack completely by pulling it towards you.

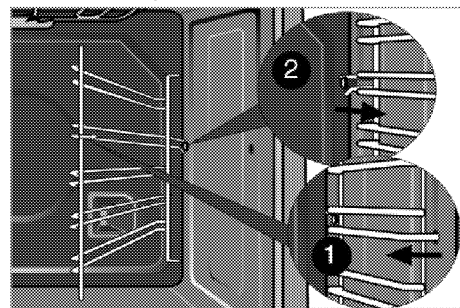

Catalytic walls

(This feature is optional. It may not exist on your product.)

The inner side walls (A) and/or the rear wall (B) of your product may be coated with catalytic enamel. Catalytic walls have a light matte colour and a porous surface. Catalytic walls of the oven should not be cleaned. Porous surfaces of the catalytic walls are automatically cleaned by absorbing and converting the spilled oil (steam and carbon dioxide).

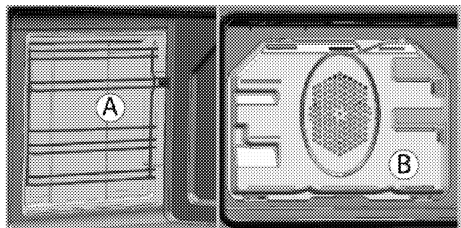

Clean oven door

To clean the oven door, use warm water with washing liquid, a soft cloth or sponge to clean the product and wipe it with a dry cloth.

i Don't use any harsh abrasive cleaners or sharp metal scrapers for cleaning the oven door. They could scratch the surface and destroy the glass.

Removing the oven door

1. Open the front door (1).
2. Open the clips at the hinge housing (2) on the right and left hand sides of the front door by pressing them down as illustrated in the figure.

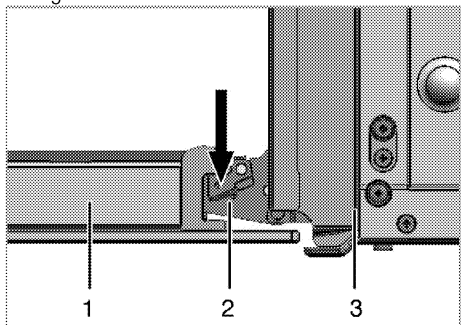

- 1 Front door
- 2 Hinge
- 3 Oven

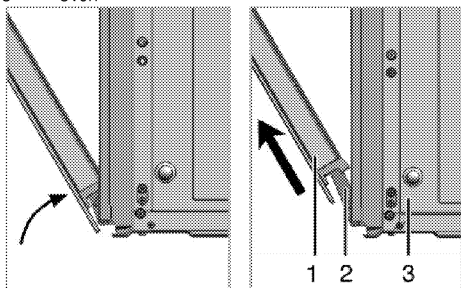

3. Move the front door to half-way.
4. Remove the front door by pulling it upwards to release it from the right and left hinges.

i Steps carried out during removing process should be performed in reverse order to install the door. Do not forget to close the clips at the hinge housing when reinstalling the door.

Replacing the oven lamp

! **DANGER:**
Before replacing the oven lamp, make sure that the product is disconnected from mains and cooled down in order to avoid the risk of an electrical shock.
Hot surfaces may cause burns!

i The lenses must be in place when using the oven.
The lenses serve to protect the light bulb from breaking.
The lenses are made of glass. Handle carefully to avoid breakage. Broken glass could cause an injury.

i Position of lamp might vary from the figure.

Each oven is equipped with one halogen lights located in the back wall of the oven. The lights are switched on when the door is opened or when the oven is in a cooking cycle. The oven lights are not illuminated during self clean. Each light assembly consist of a removable lens, a light bulb as well as a light socket housing that is fixed in place. Light bulb replacement is considered to be a routine maintenance item.

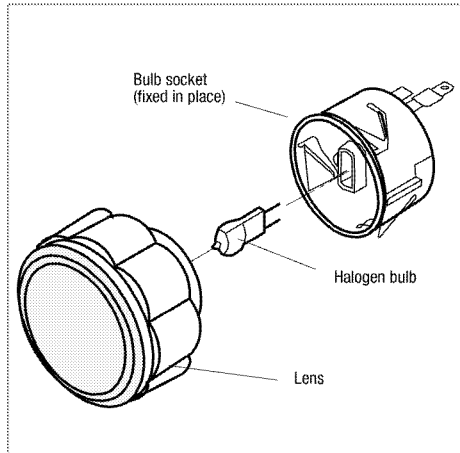

To replace a light bulb:

1. Read warning on this page.

2. Turn off power at the main power supply (your fuse or breaker box).
4. Pull out oven lamp and replace it with new one.
5. Install the glass cover and then the wire racks.

6 General information

Overview

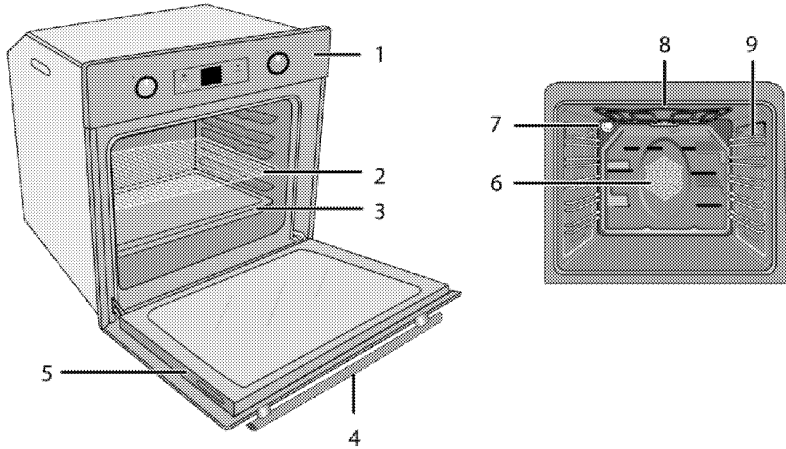

- 1 Control panel
- 2 Wire shelf
- 3 Tray
- 4 Handle
- 5 Door

- 6 Fan motor (behind steel plate)
- 7 Lamp
- 8 Top heating element
- 9 Shelf positions

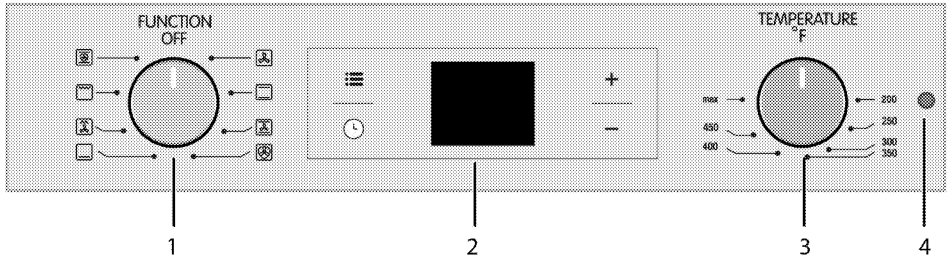

- 1 Function knob
- 2 Digital timer

- 3 Thermostat knob
- 4 Thermostat lamp

Technical specifications

GENERAL	
Outer dimensions (height/width/depth)	595 mm(23" 27/64) /594 mm(23" 25/64) /567 mm (22" 24/64)
Voltage / frequency	120/240V ~60Hz
Total electric power	2.5 kW
Fuse protection	Min. 20 A
Cable type / cross section	BC-SIL 4X15 AWG
Cable length	min. 3 max. 6ft
Main oven	Multifunction oven
Broil	2.2 kW
Inside illumination	15-25 W



Technical specifications may be changed without prior notice to improve the quality of the product.



Figures in this manual are schematic and may not exactly match your product.



Values stated on the product labels or in the documentation accompanying it are obtained in laboratory conditions in accordance with relevant standards. Depending on operational and environmental conditions of the product, these values may vary.

Package contents



Accessories supplied can vary depending on the product model. Not every accessory described in the user manual may exist on your product.

1. **User manual**

2. **Wire Shelf**

Used for roasting and for placing the food to be baked, roasted or cooked in casserole dishes to the desired rack.

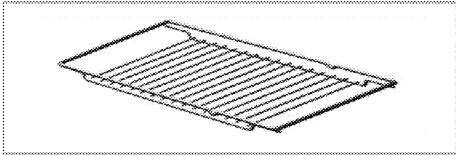

3. **Proper positioning of the wire shelf on sliding shelves**

It is important to position the broil and/or dripping pan on the wire shelves correctly. Slide the broil or the dripping pan completely between the 2 rails and make sure it is stable before putting a dish on it (Please see the following figure).

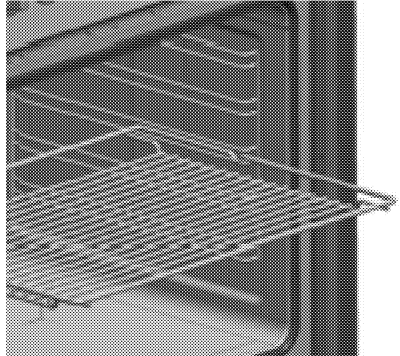
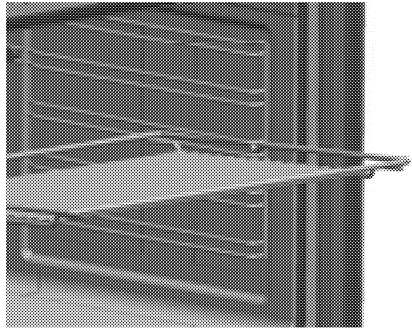

7 Troubleshooting

Oven emits steam when it is in use.

- It is normal that steam escapes during operation. >>> *This is not a fault.*

Product emits metal noises while heating and cooling.

- When the metal parts are heated, they may expand and cause noise. >>> *This is not a fault.*

Product does not operate.

- The mains fuse is defective or has tripped. >>> *Check fuses in the fuse box. If necessary, replace or reset them.*
- Product is not plugged into the (grounded) socket. >>> *Check the plug connection.*
- Buttons/knobs/keys on the control panel do not function. >>> *Keylock may be enabled. Please disable it. (See. Using the keylock, page*

Oven light does not work.

- Oven lamp is defective. >>> *Replace oven lamp.*
- Power is cut. >>> *Check if there is power. Check the fuses in the fuse box. If necessary, replace or reset the fuses.*

Oven does not heat.

- Function and/or Temperature are not set. >>> *Set the function and the temperature with the Function and/or Temperature knob/key.*
- In models equipped with a timer, the timer is not adjusted. >>> *Adjust the time.* (In products with microwave oven, timer controls only microwave oven.)
- Power is cut. >>> *Check if there is power. Check the fuses in the fuse box. If necessary, replace or reset the fuses.*

(In models with timer) Clock display is blinking or clock symbol is on.

- A previous power outage has occurred. >>> *Adjust the time / Switch of the product and switch it on again.*



Consult the Authorised Service Agent or the dealer where you have purchased the product if you can not remedy the trouble although you have implemented the instructions in this section. Never attempt to repair a defective product yourself.

8 WARRANTY STATEMENT FOR BLOMBERG ELECTRIC AND GAS RANGES

The warranties provided by Blomberg in these statements only apply to Blomberg electric and gas ranges sold to the original purchaser or homeowner in the US and Canada. This warranty is not transferable.

To obtain warranty service, please contact our nearest distributor as listed by state or call 1800-459-9848. You will need your electric and gas range model number, serial number, retailer name and address, where purchased and purchase date / installation date.

This warranty gives you specific legal rights, and you may also have other rights which vary from state to state.

All warranties stated below are based upon normal household use. The use of the product in a commercial setting will void all warranties.

Service must also be performed by an authorized Blomberg Service Agency.

Cosmetic defects must be reported within 10 business days from installation

1 year * limited warranty from date of first installation Blomberg will repair or replace at no cost to the consumer any defective parts of the electric and gas ranges

2 year * ++ limited warranty from date of first installation (Parts only) Blomberg will repair or replace any parts at no cost to the consumer if material defects or workmanship have caused the damage or failure of these components. Labor charges are the responsibility of the consumer

2-5 year * ++ limited warranty from date of first installation (Parts only) Blomberg will repair or replace oven cavity at no cost to the consumer if material defects or workmanship have caused the damage or failure of these components.

Labor charges are the responsibility of the consumer

Disclaimers of warranties and exclusions:

Warranty does not cover service costs by an authorized service agent to correct installation, electrical problems or educational instruction on the use of the electric and gas ranges. The warranty also does not cover defects or damage caused by an act of god (such as storms, floods, fires, mudslides, etc.), damage cause by use of the electric and gas ranges for purposes other than those for which it was designed, misuse, abuse, accident, alteration, improper installation, maintenance, travel fees, service calls outside normal service hours, unauthorized service work or work.

This product is fully tested and went through official quality assurance inspections before leaving the original manufacturing site. Warranty

terms for this Blomberg household appliance is not valid if the product is altered, tampered, modified, additional parts assembled, fixed and re-packed by an authorized distributor, servicer, a third party retailer, reseller or by any other unauthorized person(s).

TO THE EXTENT PERMITTED BY LAW, THIS WARRANTY IS IN LIEU OF ALL OTHER EXPRESSED AND IMPLIED WARRANTIES, INCLUDING THE IMPLIED WARRANTIES OF MERCHANTABILITY AND FITNESS FOR A PARTICULAR PURPOSE. BLOMBERG UNDERTAKES NO RESPONSIBILITY FOR THE QUALITY OF THIS PRODUCT EXCEPT AS OTHERWISE PROVIDED IN THIS WARRANTY STATEMENT. BLOMBERG ASSUMES NO RESPONSIBILITY THAT THE PRODUCT WILL BE FIT FOR ANY PARTICULAR PURPOSE FOR WHICH YOU MAY BE BUYING THIS PRODUCT, EXCEPT AS OTHERWISE PROVIDED IN THIS WARRANTY STATEMENT.

Blomberg does not assume any responsibility for incidental or consequential damages. Such damages include, but are not limited to, loss of profits, loss of savings or revenue, loss of use of the cooker or any associated equipment, cost of capital, cost of any substitute equipment, facilities or services, downtime, the claims of third parties, and injury to property. Some states do not allow the exclusion or limitation of incidental or consequential damages, so the above limitations or exclusion may not apply to you.

* installation date shall refer to either purchase date or 5 business days after delivery of the product to the home, whichever is later.

++Parts replaced will assume the identity of the original parts + their original warranty.

No Other Warranties. This Warranty Statement is the complete and exclusive warranty from the manufacturer. No employee of Blomberg or any other party is authorized to make any warranty statements in addition to those made in this Warranty Statement.

Please keep this warranty card, user manual and your sales slip for future reference.

HOW TO GET SERVICE

Please contact the Distributor for your State or Province as listed on the Distributor Contact List, or call our Toll Free Number at 1 800 459 9848 for direction to an Authorized Blomberg Service Agent. 02 01

