

USE & CARE MANUAL



BLUESTAR[®]

Electric Wall Oven

750162

BlueStar® Electric Wall Oven

Use & Care Manual

THIS APPLIANCE WAS DESIGNED FOR EASE OF INSTALLATION AND OPERATION. HOWEVER, WE RECOMMEND THAT YOU READ ALL SECTIONS OF THIS MANUAL BEFORE YOU BEGIN INSTALLATION AND USE.

DO NOT REMOVE PERMANENTLY AFFIXED LABELS, WARNINGS OR DATA PLATES FROM YOUR APPLIANCE. THIS MAY VOID THE MANUFACTURER'S WARRANTY AND/OR HINDER EFFECTIVE SERVICING AND MAINTENANCE.

THESE INSTRUCTIONS ARE TO REMAIN WITH THE APPLIANCE AND THE CONSUMER IS TO RETAIN THEM FOR FUTURE REFERENCE.

WARNING!

If the information in this manual is not followed exactly, a fire or explosion and or shock may result causing property damage, personal injury or death. FOLLOW ALL NATIONAL ELECTRICAL CODES, STATE AND OR LOCAL CODES THAT DO APPLY TO ELECTRICAL APPLIANCE.



Do not store or use gasoline or other flammable vapors and liquids in the vicinity of this or any other appliance.

WHAT TO DO IF YOU SMELL WIRE BURNING

Do not try to activate any appliance.

Do not touch or activate any electrical switch.

Please disconnect the unit by turning off the circuit breaker or fuse.

If smell continues or increases, please contact the fire department.

Installation and service must be performed by a qualified installer or service agency.

**DANGER
ELECTRICAL SHOCK HAZARD**

To avoid risk of electrical shock, personal injury, verify the unit has been properly grounded in accordance with local codes, with National Electric Code (NEC), ANSI/NFPA 70 or updated edition

NOTE: WARRANTY SERVICE MUST BE PERFORMED BY AN AUTHORIZED SERVICE AGENT. YOU MAY REQUEST WARRANTY SERVICE BY CALLING 800-449-8691. YOU MAY ALSO REQUEST SERVICE VIA THE INTERNET BY SUBMITTING THE SERVICE REQUEST FORM AT WWW.BLUESTARCOOKING.COM

THANK YOU & WELCOME

Thank you for your purchase and welcome to the BlueStar® Family!

BlueStar® ovens and ranges are designed for discerning home chefs who demand restaurant-quality results in their own kitchens. As the owner of a new BlueStar® electric wall oven you can look forward to years of culinary excellence. You will prepare meals with the speed and accuracy of a professional chef right in your own kitchen. All equipment is designed and manufactured to the highest quality standards in the industry specifically to meet the needs of the world's most demanding chef: you. From baking and broiling to stone baking and dehydrating, the electric wall oven lets you explore a variety of methods. Please review and familiarize yourself with this Use & Care Guide which includes operating and cleaning instructions as well as tips for getting the most out of your electric wall oven.

Since 1880, we have been handcrafting the highest quality ovens and ranges at our Blandon, Pennsylvania factory. If your electric wall oven ever needs attention, please be sure to use a BlueStar® certified service provider recommended by our sales service team. Our service team can be reached at 1-800-449-8691 or serviceteam@bluestarcooking.com. Please take a few moments now to fill in the Service Information on PAGE 4 for your future reference. In the event you require parts or service, this information will be needed to ensure you receive the highest quality service we can provide.

We hope you enjoy your new electric wall oven,
The BlueStar® Team

PLEASE NOTE: ALL ELECTRIC WALL OVENS SHOULD BE INSPECTED UPON ARRIVAL. PER THE WARRANTY ANY COSMETIC ISSUES MUST BE REPORTED TO YOUR DEALER WITHIN 7 DAYS OF DELIVERY. THE PERFORMANCE CHECKLIST MUST BE COMPLETED BY THE CERTIFIED INSTALLER WITHIN 15 DAYS OF INSTALLATION, AND SENT TO BLUESTAR®.

SERVICE INFORMATION

Date of Purchase

Model Number

Serial Number

Dealer Name

Dealer Phone

Dealer Address

Date of Installation

Installer Name

Installer Phone

Installer Address

Your installer should complete the Performance Checklist, found in the Installation Manual or on page 43 of this manual, before leaving your residence. Mail the completed checklist to: Warranty Department Prizer-Painter Stove Works Inc. 318 June Avenue Blandon, PA 19510 or email serviceteam@bluestarcooking.com, submit online at bluestarcooking.com.

NOTE: WARRANTY SERVICE MUST BE PERFORMED BY AN AUTHORIZED SERVICE AGENT. YOU MAY REQUEST WARRANTY SERVICE BY CALLING 800-449-8691. YOU MAY ALSO REQUEST SERVICE VIA THE INTERNET BY SUBMITTING THE SERVICE REQUEST FORM AT WWW.BLUESTARCOOKING.COM

IMPORTANT SAFETY INSTRUCTIONS

SAVE THESE INSTRUCTIONS

Read all instructions before using your appliance. Follow these important safety precautions to reduce the risk of fire, electric shock, personal injury or property damage.

Do not remove permanent labels, warnings or data plates including the serial number from your appliance. Removal may void the manufacturer's warranty and/or hinder effective servicing and maintenance.

WARNING

- This appliance requires two or more persons when lifting, handling, or moving.
- Do not use the handle or oven door to lift the oven.
- Drop down doors can be removed before installation to prevent damage to the oven while lifting and installing if desired. Not recommended to remove French/swing doors.

WARNING

If the information in this manual is not followed exactly, a fire or explosion may result causing property damage, personal injury or death.

- Your appliance should be installed by a qualified electrical installation technician. Ask the technician to show you the exact location of the circuit breaker and / or fuse on the incoming electrical panel so you know how to turn off the electricity if necessary.
- Disconnect the appliance from the electric supply before any maintenance or repairs.
- In the event of a power failure, the unit will shut off. Do not attempt to operate the appliance.
- Do not attempt to repair or replace any part of this appliance unless specified in this manual. In-warranty service must be completed by an authorized service agency.
- Do not store flammable materials in, on, or near the appliance. Keep the appliance area clean and free of combustible materials, gasoline and other flammable vapors and liquids, aerosol and sealed containers like baby food jars. Check before each use to make sure that no hazardous materials are in the area.
- Keep the ventilation of this appliance unobstructed at all times.
- All local and national codes and ordinances must be observed. Installation must conform to the local codes.
- In Canada: Installation must be in accordance with the current local code.

GENERAL SAFETY INSTRUCTION
SAVE THESE INSTRUCTIONS



- Never use this appliance as a space heater to warm a room.
- Do not touch the hot surfaces of the oven including the doors, door interior and oven interior.
- Before any maintenance or repairs are performed, disconnect the appliance from the electric supply.
- Only persons familiar with oven operation should use it.
- Persons who lack physical, sensory or mental abilities, or experience with the appliance, should use the appliance with supervision.
- This appliance is designed for Residential Use Only.
- This appliance is not approved for outdoor use.
- Do not install if damaged.
- Do not operate if not working properly or if damaged.
- Disconnect from the power supply if there is an error display message.
- Have a working smoke detector in or near the kitchen.
- Do not allow children to touch or play in, on or near the oven when in operation.
- Children should not use the unit without supervision unless its operation has been sufficiently explained so they can safely operate it. Children must be able to recognize potential hazards or improper operation.
- Only use this appliance for the intended purposes described in this user manual.
- Do not sit, stand, or climb on any part of the appliance including the oven door. Serious injury may occur.
- Do not store items of interest to children above the appliance.
- Never wear loose fitting clothing or garments with loose sleeves or strings while using this appliance.
- Do not use a steam cleaner to clean the oven since the steam could penetrate electrical components and cause a short circuit.
- Keep pet birds out of the kitchen or other rooms where kitchen fumes could reach them.
- Keep operating instructions in a safe place and pass on to any future user.



IN THE EVENT OF FIRE, TAKE THE FOLLOWING STEPS TO PREVENT INJURY AND FIRE SPREADING

- Turn off the oven and keep the oven door closed to smother the flame and prevent it from spreading.
- Turn off any ventilation units.
- If attempting to control fire use baking soda, or a dry chemical or foam fire extinguisher.
- Do NOT use water on grease fires.
- It is recommended you purchase a multi-purpose dry chemical or foam-type fire extinguisher for your home. Store it in close proximity to your appliance.

IMPORTANT SAFETY INFORMATION

SAVE THESE INSTRUCTIONS



OVEN SAFETY INSTRUCTIONS

- OVEN WILL GET HOT! Never touch the inside of the oven cavity or heating elements when in operation. Personal injury or harm may occur.
- Do NOT cover the bottom of the oven floor with aluminum foil or any oven liner.
- Only use dry oven mitts or potholders. Moist or damp potholders on hot surfaces may result in steam burns. Do not allow potholders to touch hot burner areas in the oven. Do not use a towel or other bulky material as a potholder.
- Do NOT heat unopened food containers or jarred products like baby food in the oven. The built-up pressure may cause the container to explode.
- **Keep the oven door closed at all times when operating the oven and broiling. Open only to insert or remove food.**
- Do NOT cover an entire oven rack with any material such as aluminum foil. It will block airflow throughout the oven and may cause undesired results. Aluminum foil linings may trap heat, creating a fire hazard.
- Do NOT place any pot, pan or food directly on the oven floor when baking except when using the baking stone.
- Do NOT put your face near the infrared broiler.
- Use care when opening the oven door. Let hot air or steam escape before adding or removing food.
- Do NOT store food, pots or pans, cooking equipment or containers in the oven when not in use.
- Sitting, stepping, leaning, or other misuse of the oven door can result in hazards or injuries and damage to the appliance and or user.
- Do not drape towels or other materials on the oven doors. These articles may ignite.
- Avoid reaching into the oven cavity. Use the motion of the oven racks to slide dishes in and out of the oven. Reaching into the oven cavity could result in burns or personal injury.
- Make sure the oven is cool before changing the position of the oven racks.

Safe Minimum Internal Temperature Chart

Safe steps in food handling, cooking, and storage are essential in preventing foodborne illness. You can't see, smell, or taste harmful bacteria that may cause illness. In every step of food preparation, follow the four guidelines to keep food safe:

- **Clean**—Wash hands and surfaces often.
- **Separate**—Separate raw meat from other foods.
- **Cook**—Cook to the right temperature.
- **Chill**—Refrigerate food promptly.

Cook all food to these minimum internal temperatures as measured with a food thermometer before removing food from the heat source. For reasons of personal preference, consumers may choose to cook food to higher temperatures. A holding temperature of 140 degrees or higher is recommended for food safety.

Product	Minimum Internal Temperature & Rest Time
Beef, Pork, Veal & Lamb Steaks, chops, roasts	145 °F (62.8 °C) and allow to rest for at least 3 minutes
Ground meats	160 °F (71.1 °C)
Ham , fresh or smoked (uncooked)	145 °F (60 °C) and allow to rest for at least 3 minutes
Fully Cooked Ham (to reheat)	Reheat cooked hams packaged in USDA-inspected plants to 140 °F (60 °C) and all others to 165 °F (73.9 °C).

Product	Minimum Internal Temperature
All Poultry (breasts, whole bird, legs, thighs, and wings, ground poultry, and stuffing)	165 °F (73.9 °C)
Eggs	160 °F (71.1 °C)
Fish & Shellfish	145 °F (62.8 °C)
Leftovers	165 °F (73.9 °C)
Casseroles	165 °F (73.9 °C)

Source: USDA.gov, Food Safety and Inspection Service, updated May 19, 2014

GETTING STARTED

We know you are excited to start cooking and baking with your new BlueStar oven. Before you begin, it is essential that you follow these steps for safe and optimal use.

- Become familiar with all the parts of your electric wall oven.
- Remove and properly discard all temporary labels and packaging material from the oven exterior, oven interior, oven rack glides and oven racks. Remove all cardboard, zip ties, paper and plastic sheathing used as packaging.
- Wash oven racks, and oven rack glides in hot, soapy water. Rinse well and dry thoroughly. See the Care and Cleaning section.
- Do NOT wash the baking stone. Washing the stone will allow the stone to absorb moisture and damage the stone. Do not ever submerge the baking stone in any liquid.
- Register your appliance by completing the Performance Checklist completed by your installer, and mail to the below address, email to serviceteam@bluestarcooking.com or submit online at bluestarcooking.com. The Performance Checklist can be found in the Installation Manual or on page 43 of this manual.

Warranty Department
Prizer-Painter Stoveworks
318 June Avenue
Blandon, PA 19510

ATTENTION

- Perform the **Oven Burn-Off Procedure** before using your oven the first time to remove all factory oils and residue. See page 14.
- Perform the **Pre-drying Procedure** for the baking stone before first use. See page 15.

GUIDE TO THE OVEN

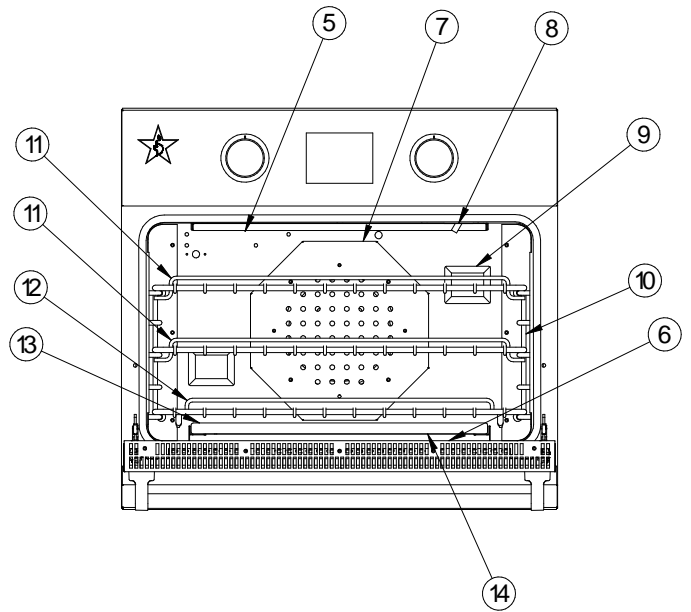
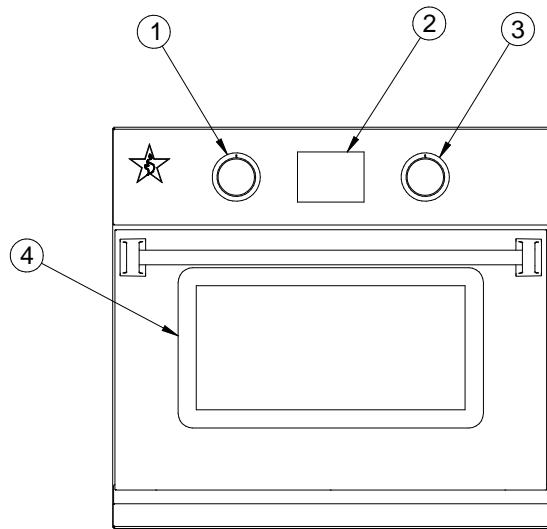

1. Quick Start Control Knob

2. Display

3. Temperature Setting (5° increments)

4. French Doors/Standard Door

5. Infrared Broiler Element

6. Infrared Heating Element

7. Convection Fan

8. Roast Probe Socket

9. Light

10. Rack Guide

11. Standard Rack (2)

12. Full Extension Rack (1)

13. Baking Stone

14. Baking Stone Temperature Probe

GUIDE TO THE OVEN CONTROLS

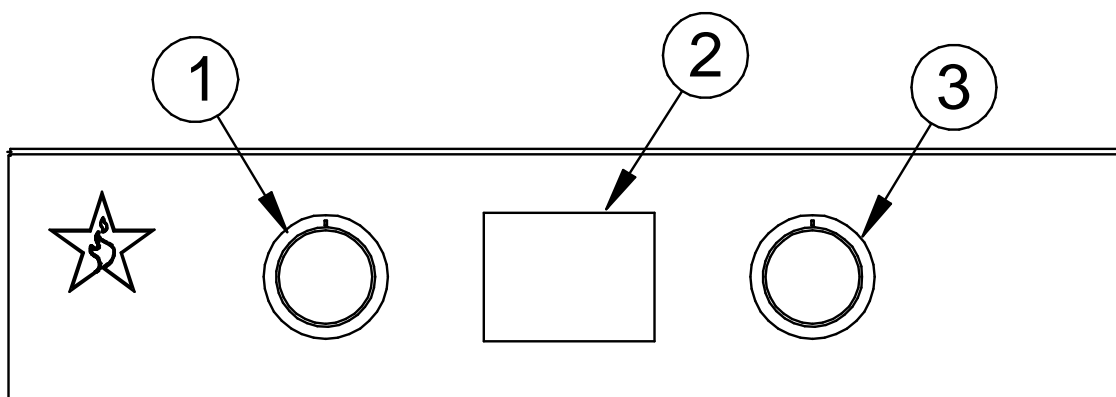

- ① **Quick Start Control Knob**
Use this knob to bypass the display screen and go directly to **Bake** mode.
- ② **Display**
Shows and instructs the use of all the oven features.
- ③ **Temperature Set**
Set a temperature.

OVEN ACCESSORIES

OVEN RACKS AND OVEN RACK GUIDES

Your oven comes equipped with two standard racks, one extension rack and two five-position rack guides. Follow your recipe guidelines to determine the best rack location for your dish.

TIP: For best results, center baking pans on the rack to allow maximum air circulation around the food.



Always use an oven rack. Never place any food, pot, pan or tray directly on the oven floor. You may place cooking vessels directly on the baking stone.

Extension Rack

The electric wall oven comes with a rack that can be pulled out fully from the oven, making it easy to handle heavy items. Although the full extension rack comes installed at the lowest position, it can be moved to any position.

Extension Rack Operation

Make sure oven is cool and rack is fully inserted into oven cavity.

To Remove

- Grasp the front of the rack and lift up slightly.
- Pull the rack towards you, until completely removed from oven cavity.

To Insert

- Grasp the slides of the rack, making sure that the slides are not extended. If extended, they can be closed by standing the back end of the rack on the floor.
- With the front end of the rack angled up, insert the top tab over the rack guide position you want to use. Tilt the rack down slightly so the bottom tab slides under the guide bar.
- Slide rack evenly into oven cavity.
- Once almost completely in the oven, secure the two tabs at the front of the extension rack in place by placing the rack guide in between

Oven Racks and Rack Guides Cleaning

- Make sure oven is cool.
- Remove oven racks and guides.
- Wash in hot, soapy water. Rinse in clear water and dry thoroughly.
- Oven racks and guides are dishwasher safe.

ROAST PROBE

The roast probe monitors the core temperature of meat and poultry in the Roast Probe mode.

- Insert the long pointed end of the probe into the thickest portion of the meat and the short end of the probe into the roast probe socket located on the right front of the interior oven wall.
- The roast probe will monitor temperatures between 65°F and 225°F.

ATTENTION

Be sure to remove the probe from the oven when not in use. The probe will be damaged if the broiler is turned on with the probe in place.

Roast Probe Cleaning

When cool, wipe the probe clean with a mild soapy water solution. Rinse and dry thoroughly.

ATTENTION

Do not put meat probe in the dishwasher.

BAKING STONE

The integrated baking stone lets you create perfectly bakes breads and pizzas. In StoneBake™ mode, the baking stone temperature probe makes sure that the stone maintains the desired temperature.

ATTENTION

The stone should be pre-dried before first use. If not pre-dried, the stone could be damaged. See page 15 for pre-drying procedure.

TIP: It is recommended to use the rough side of the pizza stone but either side is acceptable, experiment to see which you prefer.

Baking Stone Cleaning

When completely cool, the stone can be removed for cleaning.

- Scrape baked-on food with a nylon spatula. Never immerse the stone in water.

ATTENTION

- The baking stone weighs approximately 35 pounds. Use extreme care when removing from the oven.
- Make sure the stone's probe socket is seated on the stone temperature probe in the oven.
- The stone will darken in color with use. This is normal and improves the stone's performance. The stone may darken unevenly based on use, this is normal.

OPERATING THE OVEN

BEFORE YOU BEGIN

Clean removable oven parts

- Remove and properly discard all temporary labels and packaging material including cardboard, zip ties, paper and wrapping from the oven, broiler pan, oven racks, oven rack glides and exterior surfaces. Remove protective plastic wrap from any stainless steel surfaces.
- BEFORE turning on your oven for the first time, remove and wash the oven racks and rack glides in hot, soapy water. Rinse well and dry thoroughly. See the Care and Cleaning guide for more details.
- Perform the Oven Burn-Off Procedure.

ATTENTION

IF JUST DOING OVEN BURN OFF REMOVE BAKESTONE LOCATED ON THE OVEN BOTTOM. IF PRE-DRYING THE BAKESTONE, THE OVEN BURN OFF PROCEDURE IS NOT NEEDED. STONE CONDITIONING MUST BE COMPLETED BEFORE USING THE BAKING STONE.

Oven Burn-Off Procedure

The entire Burn-Off Procedure takes about 100 minutes.

WARNING

Remove the baking stone before performing the Oven Burn-Off Procedure. If not removed, it could shatter. The stone drying procedure can be used in lieu of the burn-off procedure.

ATTENTION

New appliances are wiped clean with solvents at the factory prior to shipping. The Burn-Off procedure burns off any remaining processing residue.

CAUTION

Failing to perform the Oven Burn-Off Procedure before first use of the oven may result in undesirable odors, flavors, and excessive smoke when you use your oven the first time.

- Make sure your appliance has been installed properly and all performance checks and adjustments are completed.
- Turn on ventilation hood and make sure entire room is well-ventilated.
- Check that the oven cavity is empty. The baking stone, oven racks, oven guides, roast probe and any other object should NOT be in the oven.
- Initiate the **Self-Clean** cycle. See page 37.

ATTENTION

- The Oven Burn-Off Procedure can be completed by running the Self-Clean Cycle.

- After the Self-Clean cycle is complete, allow oven to cool completely.
- Insert oven rack guides and racks.
- Your oven is now ready for use.

ATTENTION

You may notice the following events during the Oven Burn-Off Procedure. All are normal.

- Strong odor
- Some smoke
- Condensation on the front of the oven including the oven door, oven window, control panel and side panel.

WARNING

Your oven is not a storage compartment. Do NOT place food, pots or pans, cooking equipment or storage containers in the oven when not in use.

PRE-DRY THE BAKING STONE

Your baking stone must be pre-dried before using it to prevent warping and maximize its life. If the stone is not properly dried before its first use, it could warp, crack or shatter with explosive force.

Follow the pre-drying instructions and document the start time for each step to keep track of your activity.

ATTENTION

- The entire pre-drying process will take six hours and must be followed exactly as directed.
- Keep the oven door closed throughout the entire pre-drying process.
- An odor and out-gassing may occur during the initial heat-up. This is normal as the stone adjusts to its environment.

1. Allow the baking stone to come to room temperature before starting.
2. Press **Cook Modes** on the Main Menu display. *Figure 1*
3. Press **Bake** on the Select Cook Mode screen. *Figure 2*
4. Press **Set Temp** on the Bake screen. *Figure 3*
5. Press **Other** on the Set Temperature screen. *Figure 4*
6. Enter **2-0-0** and press **Start** on the Bake screen. Maintain the 200 degrees F. setting for three hours. *Figure 5*
7. Do not open the oven door. After three hours at 200 degrees F., select **Back** on the Bake screen.
8. Enter **3-0-0** and press **Start**. Maintain the 300 degrees F. setting for one hour.
9. Do not open the oven door. After one hour at 300 degrees F., select **Back** on the Bake screen.
10. Enter **4-0-0** and press **Start**. Maintain the 400 degrees F. setting for one hour.
11. Do not open the oven door. After one hour at 400 degrees F., select **Back** on the Bake screen.
12. Enter **5-0-0** and press **Start**. Maintain the 500 degrees F. setting for one hour.
13. After one hour at 500 degrees F., your baking stone is ready for use.



Figure 1



Figure 2



Figure 3



Figure 4



Figure 5

TIPS

- Sprinkle a light dusting of baking flour on the stone to help season it before baking the first time. The flour allows air to flow between the stone and the item to be baked. Never use any type of oil on the stone.
- It is recommended to cook doughs on the rough surface.
- The stone can be used with either the rough or the smooth surface, depending on your preference.
- Do not allow any liquid to come in contact with the stone.
- Accidental spillage of liquid onto the stone during cooking procedures is acceptable, but liquid should not be applied directly to the stone.
- To clean, after the stone is cool, use a nylon scraper or dry cloth to remove crumbs or baked on residue. Never use an abrasive sponge or brush. Never immerse the stone in any liquid.

ATTENTION

- With each use, the stone becomes seasoned and darkens, making it more effective. The stone may darken unevenly based on use, this is normal.

WARNING

- Failure to follow the installation instructions and warnings regarding liquids contacting the stone and stone being immersed in liquid may result in the baking stone disintegrating with explosive force.
- Handle the baking stone carefully. If the stone knocks a hard surface, it may crack or develop hairline fractures that may expand over time and lead to premature product failure. The stone is still usable with hairline cracks.
- Do not subject the stone to thermal shock. Foods cannot be thawed directly on the baking stone.
- Never place the baking stone over an open flame.
- Only dough-based foods like pizza or bread should be baked directly on the stone surface. Any other food that will be stone baked should be placed in a cooking vessel before placing it on the stone.

OPERATING THE OVEN

DISPLAY SCREEN

All the oven's functions operate from the display screen. When the oven is not in use, the screen displays the time and the BlueStar logo.

- Press the **BlueStar® logo** to start any oven operation. Note: If “Locked” is displayed, press the BlueStar® logo for five seconds and release to unlock the display. *Figure 1*
- The Welcome screen will appear briefly. *Figure 2*

ATTENTION

Any time the display screen is in use, a fan will automatically turn on to keep the electrical components and computer hardware cool. The display screen fan might stay on for several minutes or hours after the oven is turned off. The message **Oven Cooling** will be displayed until cavity temperature goes below 200°F.

LOCK

1. To lock the display screen to prevent accidental operation of the oven, go to the Main Menu and press and hold **Lock** for five seconds, then release. *Figure 3*
2. To unlock the display screen, press and hold **BlueStar® logo** for five seconds, then release. *Figure 1*.

CLOCK

1. To set the oven clock, press the **BlueStar logo**. *Figure 1*
2. Press **Other** on the Main Menu screen. *Figure 3*
3. Press **Clock** on the Other screen. *Figure 4*
4. Use the keypad to enter the **Hours** and **Minutes** and **AM** or **PM**, then press the **Set** button to confirm your entry. *Figure 5*

LIGHT

1. To turn on the oven light, press the **light bulb icon** that appears on the lower right corner of the display. Press the light bulb icon again to turn the light off.

CONVECTION FAN

1. Press the **fan icon** on the lower left side of the display screen to begin convection cooking.
2. In all cooking modes there is a Conv. Fan on/off button that can be selected when cooking.

ATTENTION

Certain cooking modes require the convection fan to be on or off and the fan icon will be inactive. See the chart on page 19.

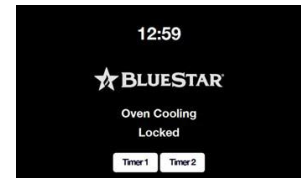

Figure 1



Figure 2



Figure 3



Figure 4



Figure 5

KITCHEN TIMER

The kitchen timer can be set by:

1. Select **Time 1** or **Timer 2** from Touch Screen. *Figure 1*
2. Use the buttons on the screen to select the desired time, and press **Start**. *Figure 2*
3. The Kitchen Timer running time screen will appear briefly. *Figure 3*

ATTENTION

- The Kitchen Timer screen will move to the background and the last screen displayed will appear.
- If you are not using the oven and only using the Kitchen Timer, that screen will remain displayed.
- To view the timer countdown, select **Timer** on the display screen.
- When the oven is in any cooking mode, the kitchen timer can be operated by selecting **Timer** on the Touch Screen.

4. When time has expired, an alarm sounds and the Kitchen Timer screen appears.
5. Press **Cancel** to stop the timer and return to the last screen displayed.
6. Press **Edit** to stop the timer or change the timer setting. If no new time is set, an alarm will sound, prompting you to select a new time.

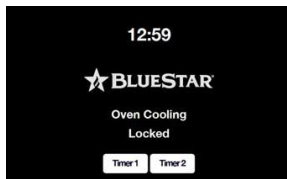

Figure 1



Figure 2



Figure 3

OPERATING THE OVEN

MODES

Your electric wall oven has 17 operating modes: **Bake, Roast, Probe Roast, Broil, StoneBake™, Proof, Dehydrate, Convection Bake, Convection Roast, Convection Probe Roast, Convection Broil, Convection StoneBake™, Convection Proof, Convection Dehydrate, Sabbath, Convection Sabbath and Clean.** Each mode has pre-set minimum and maximum temperature ranges.

CONVECTION FAN

You have the option of using the convection fan for many modes. Using the convection fan typically decreases cooking time while using a lower temperature.

Mode	Convection Fan Status
Preheat for all modes	Auto On
Proof	Select On/Off
Dehydrate	Select On/Off
Hold & Keep Warm	Select On/Off
Bake	Select On/Off
Roast	Select On/Off
Probe Roast	Select On/Off
Broil	Select On/Off
StoneBake	Select On/Off
Sabbath	Select On/Off
Clean	Auto On

ATTENTION

When the Convection Fan is in Auto On mode, the user will not be able to change its status. The convection fan will also run whenever the elements are energized.

DISPLAY SCREEN

All the oven's functions operate from the display screen.

The Main Menu screen displays the time and the BlueStar logo and two kitchen timers.

- Press the **BlueStar® logo** to start any oven operation. Note: If "Locked" is displayed, press the BlueStar® logo for five seconds and release to unlock the display. *Figure 1*
- The Welcome screen will appear briefly. *Figure 2*
- The **Main Menu** screen appears

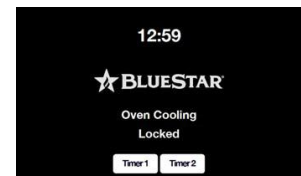

Figure 1



Figure 2

OPERATING THE OVEN WITH LEFT KNOB

TOUCH SCREEN CONTROL PANEL

Regardless of the cooking mode you select, your oven preheats using a combination of the infrared heating element, the broiling element and the convection fan.

ATTENTION

It is critical that you do not place food in the oven until the preheating cycle is complete.

The Quick Start Control Knob lets you bypass the **Welcome** and **Main Menu** screen scroll through available cook modes. *Figure 1*

QUICK START CONTROL KNOB

1. Turn the left control knob to enter individual cook modes. Move the knob in either direction to scroll through Cook Modes. *Figure 1*
2. Once in the preferred cook mode. Turn right knob in either direction to set temperature. Moving the knobs will increase/decrease the temperature in 5° increments until you reach your desired temperature. Hit **Start**. *Figure 1*
3. The oven will begin preheating. *Figure 2*
4. If desired, press the **Fan** icon or **Conv Fan** for convection baking, then press **Start**. **Convection Bake** will be displayed. See the **TIPS** section for Convection Baking recommendations.
5. When the oven is preheated, the controller alarm will sound and the **Oven Ready** screen will appear. *Figure 3*
6. Place baking dish in oven and select **Start**.*
7. At the end of the selected bake time, the **Cooking Complete** screen is displayed. An alarm will signal twice and then once every 10 seconds until one of the following actions is taken.
 - a. Select **Off** to turn off the oven and remove food.
 - b. Select **Continue Cooking** to return to the Bake screen.
 - c. Select **Hold & Keep Warm** to keep your food in the oven at a specific temperature until you are ready to serve. *Figure 5*
8. If you select **Hold & Keep Warm**, press the **Set Temp** to display the set temperature screen. *Figure 6*

ATTENTION

- Do not place food in the oven before or during the preheating process. The oven uses a combination of heating elements during the preheating process to achieve the specified temperature.
- Beware that the oven loses heat slowly and that food will continue cooking in the **Hold & Warm** mode.
- Keeping the oven light on while baking will increase the oven temperature approximately 15 degrees F.

*SET COOKING TIME

1. From the Bake screen, press **Cook Time**. *Figure 7*
2. Use the buttons on the touchpad to select desired cooking time, and press **Set**.
3. Return to the last screen displayed.



Figure 1

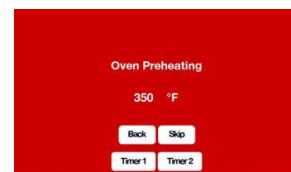

Figure 2

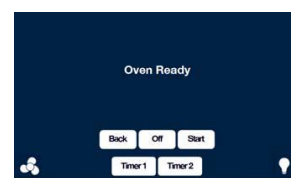

Figure 3



Figure 4



Figure 5



Figure 6



Figure 7

OPERATING THE OVEN USING THE DISPLAY PANEL

BAKE

1. Press **Cook Modes** on the Main Menu display. *Figure 1*
2. Press **Bake** on the Select Cook Mode screen. *Figure 2*
3. Press **Set Temp** on the Bake screen. *Figure 3*
4. Select one of the preset Bake temperatures or press **Other** to enter a different temperature. *Figure 4*
5. If desired, press the **Fan** icon or **Conv Fan** for convection baking, then press **Start**. **Convection Bake** will be displayed. *Figure 3* See the **TIPS** section for Convection Baking recommendations.
6. If Other, enter your desired temperature, then **Start**. *Figure 5*
7. The oven will begin preheating. *Figure 6*
8. When the oven is preheated, the alarm will sound and the **Oven Ready** screen will appear. *Figure 7*
9. Place baking dish in oven and select **Start**.*
10. At the end of the selected bake time, the **Cooking Complete** screen is displayed. An alarm will signal three times and then once every 10 seconds until one of the following actions is taken.
 - a. Select **Off** to turn off the oven and remove food.
 - b. Select **Continue Cooking** to return to the Bake screen.
 - c. Select **Hold & Keep Warm** to keep your food in the oven at a specific temperature until you are ready to serve. *Figure 10*
11. If you select **Hold & Keep Warm**, press the **Set Temp** to display the set temperature screen.

- Do not place food in the oven before or during the preheating process. The oven uses a combination of heating elements during the preheating process to achieve the specified temperature.
- Beware that the oven loses heat slowly and that food will continue cooking in the **Hold & Warm** mode.
- Keeping the oven light on while baking will increase the oven temperature approximately 15 degrees F.

ATTENTION

*SET COOKING TIME

1. From the Bake screen, press **Cook Time**. *Figure 3*
2. Use the buttons on the touchpad to select desired cooking time, and press **Set**. *Figure 9*
3. Return to the last screen displayed.
4. If the cooking timer is not populated, the oven will continue to operate at the set temperature.



Figure 1



Figure 2



Figure 3



Figure 4



Figure 5

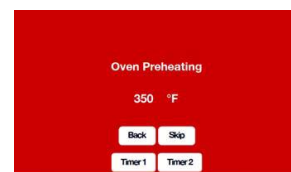

Figure 6

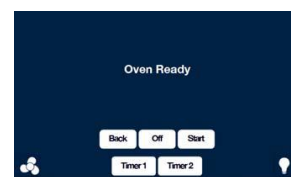

Figure 7



Figure 8



Figure 9



Figure 10

TIPS

TEMPERATURE RANGE

In **Bake** mode, the oven can operate at temperatures between 150 and 500 degrees F. Entering a temperature outside of this range will result in an error message.

CONVECTION COOKING

Convection cooking uses a fan inside the oven to circulate the heated air more evenly, resulting in better heat distribution and a more consistent temperature.

In general, convection baking takes less time at lower temperatures than traditional baking.

For best results:

- Reduce the recommended recipe temperature 25°F to 50°F.
- Reduce the recommended cooking time.
- Closely monitor the first batch of each new recipe.
- Keep a record of temperature, time and weight for each recipe. Adjust accordingly for the next batch.
- Center baking dishes on the racks for maximum air flow, allowing at least 1" between pans.
- Select a baking dish that has no or low sides like a broiler pan so that the air can circulate freely around the food.

OPERATING THE OVEN

BROIL

1. Press **Cook Modes** on the Main Menu display. *Figure 1*
2. Press **Broil** on the Select Cook Mode screen. *Figure 2*
3. Press **Set Temp** on the Broil screen. *Figure 3*
4. Select a broil temperature of **Low** or **High**.
 - a. In Broil mode, the oven will operate at temperatures at either Low (450 degrees F.) or High (550 degrees F).
5. If desired, press the **Fan** icon or **Conv Fan** for convection baking, then press **Start**. **Convection Broil** will be displayed.
6. **Oven Ready** screen will appear, place baking dish in oven and select **Start**.* *Figure 4*

ATTENTION

- Keep the oven door shut while broiling.

7. At the end of the selected cook time, the **Cooking Complete** screen is displayed. An alarm will signal three times and then once every 10 seconds until one of the following actions is taken. *Figure 5*
 - a. Select **Off** to turn off the oven and remove food.
 - b. Select **Continue Cooking** to return to the Bake screen.
 - c. Select **Hold & Keep Warm** to keep your food in the oven at a specific temperature until you are ready to serve. *Figure 7*
8. If you select **Hold & Keep Warm**, press the **Set Temp** to display the set temperature screen. Given the high temperature settings of the Broil Mode, the oven will take longer to reduce to Hold & Keep Warm Temperature. *Figure 8*
 - Beware that the oven loses heat slowly and that food will continue cooking in the **Hold & Warm** mode.
 - Keeping the oven light on while baking will increase the oven temperature approximately 15 degrees F.

*SET COOKING TIME

1. From the Broil screen, press **Cook Time**. *Figure 3*
2. Use the buttons on the touchpad to select desired cooking time, and press **Set**. *Figure 6*
3. Return to the last screen displayed.
4. If the cooking timer is not populated, the oven will continue to operate at the set temperature.



Figure 1



Figure 2



Figure 3

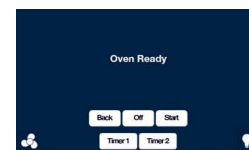

Figure 4



Figure 5



Figure 6



Figure 7



Figure 8

TIPS: CONVECTION COOKING

Convection cooking uses a fan inside the oven to circulate the heated air more evenly, resulting in better heat distribution and a more consistent temperature.

In general, convection baking takes less time at lower temperatures than traditional baking.

For best results:

- Reduce the recommended recipe temperature 25°F to 50°F.
- Reduce the recommended cooking time.
- Closely monitor the first batch of each new recipe.
- Keep a record of temperature, time and weight for each recipe. Adjust accordingly for the next batch.
- Center baking dishes on the racks for maximum air flow, allowing at least 1" between pans.
- Select a baking dish that has no or low sides like a broiler pan so that the air can circulate freely around the food.

OPERATING THE OVEN

ROAST WITHOUT THE ROAST PROBE

1. Press **Cook Modes** on the Main Menu display. *Figure 1*
2. Press **Roast** on the Select Cook Mode screen. *Figure 2*
3. Press **No** when asked if a meat probe will be used. *Figure 3*
4. Press **Set Temp** on the Roast screen. *Figure 4*
5. Select one of the preset Roast temperatures or press **Other** to enter a different temperature. *Figure 5*
6. If **Other**, enter your desired temperature, then **Start**. *Figure 6*
7. If desired, press the **Fan** icon or **Conv Fan** for convection baking, then press **Start**. **Convection Roast** will be displayed. See the **TIPS** section for Convection Baking recommendations.
8. The oven will begin preheating. *Figure 7*
9. When the oven is preheated, the alarm will sound and the **Oven Ready** screen will appear. *Figure 8*
10. Place baking dish in oven and select **Start**.*
11. At the end of the selected bake time, the **Cooking Complete** screen is displayed. An alarm will signal twice and then once every 10 seconds until one of the following actions is taken. *Figure 9*
 - a. Select **Off** to turn off the oven and remove food.
 - b. Select **Continue Cooking** to return to the Roast screen.
 - c. Select **Hold & Keep Warm** to keep your food in the oven at a specific temperature until you are ready to serve. *Figure 11*
12. If you select **Hold & Keep Warm**, press the **Set Temp** to display the set temperature screen.

ATTENTION

- Do not place food in the oven before or during the preheating process. The oven uses a combination of heating elements during the preheating process to achieve the specified temperature.
- Beware that the oven loses heat slowly and that food will continue cooking in the **Hold & Warm** mode.
- Keeping the oven light on while baking will increase the oven temperature approximately 15 degrees F.

*SET COOKING TIME

1. From the Roast screen, press **Cook Time**. *Figure 4*
2. Use the buttons on the touchpad to select desired cooking time, and press **Set**. *Figure 10*
3. Return to the last screen displayed.
4. If the cooking timer is not populated, the oven will continue to operate at the set temperature.



Figure 1



Figure 2



Figure 3



Figure 4



Figure 5



Figure 6

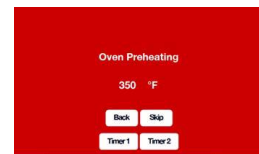

Figure 7

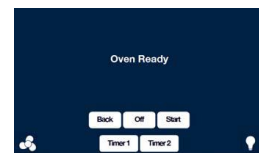

Figure 8



Figure 9



Figure 10



Figure 11

TEMPERATURE RANGE

In Roast without the probe mode, the oven can operate at temperatures between 150 and 500 degrees F. Entering a temperature outside of this range will result in an error message.

CONVECTION COOKING

Convection cooking uses a fan inside the oven to circulate the heated air more evenly, resulting in better heat distribution and a more consistent temperature.

In general, convection baking takes less time at lower temperatures than traditional baking.

For best results:

- Reduce the recommended recipe temperature 25°F to 50°F.
- Reduce the recommended cooking time.
- Closely monitor the first batch of each new recipe.
- Keep a record of temperature, time and weight for each recipe. Adjust accordingly for the next batch.
- Center baking dishes on the racks for maximum air flow, allowing at least 1" between pans.
- Select a baking dish that has no or low sides like a broiler pan so that the air can circulate freely around the food.

OPERATING THE OVEN

ROAST WITH THE ROAST PROBE

1. Press **Cook Modes** on the Main Menu display. *Figure 1*
2. Press **Roast** on the Select Cook Mode screen. *Figure 2*
3. Press **Yes** when asked if a meat probe will be used. *Figure 3*
4. Insert the short end of the probe into the oven wall socket and the long end into the thickest portion of the meat. Press **Start**. *Figure 4*
5. Press **Set Temp** on the Roast screen. *Figure 5*
6. Select one of the pre-set Roast with Probe temperatures or press **Other** to enter a different **oven** temperature. *Figure 6*
7. If **Other**, enter your desired oven temperature, then **Back**. *Figure 7*
8. Press **Probe Temp** on the Roast Screen.
9. Select one of the preset **internal meat** temperatures or press **Other** to enter a different meat temperature. *Figure 6*
10. If **Other**, enter your desired internal meat temperature, then **Start**. *Figure 7*

ATTENTION

- See page 8 for the USDA's recommendations on safe minimum internal temperatures.
- Do not place food in the oven before or during the preheating process. The oven uses a combination of heating elements during the preheating process to achieve the specified temperature.
- Roast Probe must be fully inserted into protein for proper operation. If not fully inserted probe may indicate inaccurate temperature.

11. If desired, press the **Fan** icon or **Conv Fan** for convection roasting, then press **Start**. **Convection Roast** will be displayed. See the **TIPS** section for Convection Baking recommendations.
12. Select **Start** from the Roast screen. *Figure 5*
 - A temperature will be displayed under **Probe Temp**. It will start around 60°F and then increase as the product temperature increases. Maximum display temperature is 225°F.
13. When the product has reached the desired internal temperature, an alarm will sound and the **Cooking Complete** screen is displayed. An alarm will signal three times and then once every 10 seconds until one of the following actions is taken. *Figure 8*
 - a. Select **Off** to turn off the oven and remove food.
 - b. Select **Continue Cooking** to return to the Roast screen.
 - c. Select **Hold & Keep Warm** to keep your food in the oven at a specific temperature until you are ready to serve. *Figure 9*
14. If you select **Hold & Keep Warm**, press the **Set Temp** to display the set temperature screen. Your food will continue cooking. *Figure 6*

ATTENTION

- Beware that the oven loses heat slowly and that food will continue cooking in the **Hold & Warm** mode.
- Keeping the oven light on while baking will increase the oven temperature approximately 15 degrees F.

WARNING

- The oven probe will be **HOT!** Use a dry pot holder to remove the probe from the meat and from the oven socket.



Figure 1



Figure 2



Figure 3



Figure 4



Figure 5



Figure 6



Figure 7



Figure 8



Figure 9

TEMPERATURE RANGE

The oven probe temperature can be set between 80 and 200 degrees F., ensuring your dish cooks to the precise internal temperature you want.

In Roast with Oven Probe mode, the oven can operate at temperatures between 150 and 500 degrees F. Entering a temperature outside of this range will result in an error message.

CONVECTION COOKING

Convection cooking uses a fan inside the oven to circulate the heated air more evenly, resulting in better heat distribution and a more consistent temperature.

In general, convection baking takes less time at lower temperatures than traditional baking.

For best results:

- Reduce the recommended recipe temperature 25°F to 50°F.
- Reduce the recommended cooking time.
- Closely monitor the first batch of each new recipe.
- Keep a record of temperature, time and weight for each recipe. Adjust accordingly for the next batch.
- Center baking dishes on the racks for maximum air flow, allowing at least 1" between pans.
- Select a baking dish that has no or low sides like a broiler pan so that the air can circulate freely around the food.

OPERATING THE OVEN STONEBAKE™ MODE

WARNING

- Your baking stone must be pre-dried before first use to prevent damaging it. See page 15.
- Failure to follow the installation instructions and warnings may result in the baking stone disintegrating with explosive force.
- The baking stone weighs approximately 35 pounds. Handle with care.
- If the stone knocks a hard surface, it may crack or develop hairline fractures that may expand over time and lead to premature product failure. Stone may still be used with hairline cracks.
- Do not subject the stone to thermal shock. Foods cannot be thawed directly on the baking stone.
- Never place the baking stone over an open flame.
- Only dough-based foods like pizza or bread should be baked directly on the stone surface. Any other food should be placed in a cooking vessel.

ATTENTION

Remove all racks before pre-heating the oven when using StoneBake™.

1. Press **Cook Modes** on the Main Menu display. *Figure 1*
2. Press **StoneBake™** on the Select Cook Mode screen. *Figure 2*
3. Press **Set Temp** on the StoneBake™ screen. *Figure 3*
4. Select one of the preset StoneBake™ temperatures or press **Other** to enter a different temperature. *Figure 4*
5. If **Other**, enter your desired temperature, then **Start**. *Figure 5*
6. If desired, press the **Fan** icon or **Conv Fan** for convection stone baking, then press **Start**. **Convection StoneBake** will be displayed. See the **TIPS** section for Convection recommendations.
7. The *stone* will begin preheating. *Figure 6*
8. When the stone is preheated, the alarm will sound and the **Oven Ready** screen will appear. *Figure 7*
9. Place the dough or oven safe dish directly on the stone and select **Start**.*
10. At the end of the cooking time, the **Cooking Complete** screen is displayed. An alarm will signal twice and then once every 10 seconds until one of the following actions is taken. *Figure 8*
 - a. Select **Off** to turn off the oven and remove food.
 - b. Select **Continue Cooking** to return to the Bake screen.
 - c. Select **Hold & Keep Warm** to keep your food in the oven at a specific temperature until you are ready to serve. Due to the higher degrees that StoneBake™ operates at, it will take longer to reach the hold & keep warm temperature.
11. If you select **Hold & Keep Warm**, press the **Set Temp** to display the set temperature screen. *Figure 5*

ATTENTION

- The oven uses a combination of heating elements during the preheating process to achieve the specified temperature.
- Do not place food in the oven before or during the preheating process.
- Keeping the oven light on while baking will increase the oven temperature approximately 15 degrees F.



Figure 1



Figure 2



Figure 3



Figure 4



Figure 5

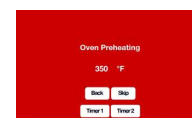

Figure 6

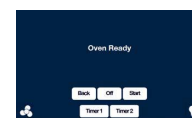

Figure 7



Figure 8



Figure 9

*SET COOKING TIME

1. From the StoneBake™ screen, press **Cook Time**. *Figure 3*
2. Use the buttons on the touchpad to select desired cooking time, and press **Set**. *Figure 9*
3. Return to the last screen displayed.
4. If the cooking timer is not populated, the oven will continue to operate at the set temperature.

TIPS

- During StoneBake™ mode both the bottom bake element and the broiler turn on to maintain the oven cavity temperature. If you are getting too much browning on the top of what you are cooking, place a baking sheet on the second rack from the top. If you are baking bread you may already have a broiler pan with water in this position.

ATTENTION

- The baking stone weighs about 35 pounds.
- Make sure the stone is cool and use extremely caution when removing it from the oven.

PRE-DRYING THE BAKING STONE

See page 15 for instructions on pre-drying the baking stone.

TEMPERATURE RANGE

In StoneBake mode, the stone temperature can be set between 250 and 500 degrees F. Entering a temperature outside of this range will result in an error message.

FOOD PLACEMENT

1. Place a dough-based product like pizza or bread directly on the baking stone. Any other food should be placed in an appropriate vessel on the baking stone.
2. Either the rough or the smooth side of the stone can be the baking surface. Experiment with your recipes and take notes for future baking.

TIP: The rough side of the stone is better for doughs, as they do not easily stick to it.

CONVECTION COOKING

Convection cooking uses a fan inside the oven to circulate the heated air more evenly, resulting in better heat distribution and a more consistent temperature.

In general, convection baking takes less time at lower temperatures than traditional baking.

For best results:

- Reduce the recommended recipe temperature 25°F to 50°F.
- Reduce the recommended cooking time.
- Closely monitor the first batch of each new recipe.
- Keep a record of temperature, time and weight for each recipe. Adjust accordingly for the next batch.
- Center baking dishes on the racks for maximum air flow, allowing at least 1" between pans.
- Select a baking dish that has no or low sides like a broiler pan so that the air can circulate freely around the food.

BAKING PIZZA AT HOME

Why cook pizza at high temperatures?

It's a little bit like popcorn. Popcorn needs extreme heat for the moisture inside the kernel to convert to steam, expanding rapidly and exploding the outer hull. If you cooked popcorn at a low temp, it would dry out and never pop.

With pizza, you don't have a hull containing this pressure, but the pressure of the expanding gases is still vital to the volume achieved in the baked product. Without intense heat, the gases don't expand as rapidly and you don't achieve the same volume/oven spring. Longer bakes produce denser crumbs. Dense crumbs are perfectly fine for bagels, but, for pizza, you want puff.

As you get into more advanced home pizza making, you learn that temperature is relative. It becomes less about high temps and more about high heat transfer and increased thermal mass. Certain materials conduct heat faster, so a thin ceramic tile may give you a mediocre 12 minute bake at 550°, while a 3/4" thick baking stone will give you phenomenal puffy pizza in 5 minutes.

The limits are raw dough. As you increase the heat transfer rate, you'll hit a point where the outside of the crust is cooked but the inside is still raw. In fast baked Neapolitan pizza, this is called a gum line, and, while some people like that little raw-ness, it is generally considered a defect.

Experimentation is the key to success. Try different temperatures, different times, and different dough recipes until you find the combination that you like the best. It is a good idea to write down the different combinations you experiment with so you can repeat them in the future.

OPERATING THE OVEN PROOF

1. Press **Cook Modes** on the Main Menu display. *Figure 1*
2. Press **Proof** on the Select Cook Mode screen. *Figure 2*
3. Press **Set Temp** on the Proof screen. *Figure 3*
4. Select one of the preset Proof temperatures or press **Other** to enter a different temperature. *Figure 4*
5. If **Other**, enter your desired temperature, then **Start**. *Figure 5*
6. The oven will begin preheating. *Figure 6*
7. When the oven is preheated, the alarm will sound and the **Oven Ready** screen will appear. *Figure 7*
8. Place baking dish in the oven and select **Start**.*
9. At the end of the selected bake time, the Cooking Complete screen is displayed. An alarm will signal twice and then once every 10 seconds until one of the following actions is taken. *Figure 8*
 - a. Select **Off** to turn off the oven and remove food.
 - b. Select **Continue Cooking** to return to the Proof screen.
 - c. Select **Hold & Keep Warm** to keep your food in the oven at a specific temperature until you are ready to serve. *Figure 10*
10. If you select **Hold & Keep Warm**, press the **Set Temp** to display the set temperature screen. *Figure 4*

- Do not place food in the oven before or during the preheating process. The oven uses a combination of heating elements during the preheating process to achieve the specified temperature.
- Beware that the oven loses heat slowly and that food will continue cooking in the **Hold & Warm** mode.
- Keeping the oven light on while baking will increase the oven temperature approximately 15 degrees F.

ATTENTION

*SET COOKING TIME

1. From the Proof screen, press **Cook Time**. *Figure 3*
2. Use the buttons on the touchpad to select desired cooking time, and press **Set**. *Figure 9*
3. Return to the last screen displayed.
4. If the cooking timer is not populated, the oven will continue to operate at the set temperature.



Figure 1



Figure 2



Figure 3



Figure 4



Figure 5

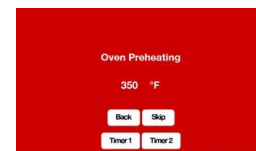

Figure 6

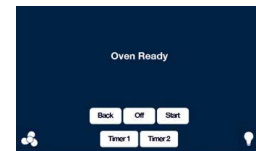

Figure 7



Figure 8



Figure 9



Figure 10

TEMPERATURE RANGE

In Proof mode, the oven can operate at temperatures between 80 and 200 degrees F. Entering a temperature outside of this range will result in an error message.

OPERATING THE OVEN

DEHYDRATE

ATTENTION

Foods must be dried to below .60 water activity or dry to the touch to be safely stored with no danger of mold, yeasts or bacteria growing.

1. Press **Cook Modes** on the Main Menu display. *Figure 1*
2. Press **Dehydrate** on the Select Cook Mode screen. *Figure 2*
3. Press **Set Temp** on the Dehydrate screen. *Figure 3*
4. Select one of the preset Dehydrate temperatures or press **Other** to enter a different temperature. *Figure 4*
5. If **Other**, enter your desired temperature, then **Start**. *Figure 5*
 - In Dehydrate mode, the oven can operate at temperatures between 80 and 200 degrees F. Entering a temperature outside of this range will result in an error message.
6. The oven will begin preheating. *Figure 6*
7. When the oven is preheated, the alarm will sound and the **Oven Ready** screen will appear. *Figure 7*
8. Place your baking dish in the oven and press **Start**.*
9. At the end of the selected dehydrating time, the Cooking Complete screen is displayed. An alarm will signal twice and then once every 10 seconds until one of the following actions is taken. *Figure 8*
 - a. Select **Off** to turn off the oven and remove food.
 - b. Select **Continue Cooking** to return to the Dehydrate screen.
 - c. Select **Hold & Keep Warm** to keep your food in the oven at a specific temperature until you are ready to serve. *Figure 10*
10. If you select **Hold & Keep Warm**, press the **Set Temp** to display the set temperature screen. *Figure 4*

ATTENTION

- Do not place food in the oven before or during the preheating process. The oven uses a combination of heating elements during the preheating process to achieve the specified temperature.
- Beware that the oven loses heat slowly and that food will continue cooking in the **Hold & Warm** mode.
- Keeping the oven light on while baking will increase the oven temperature approximately 15 degrees F.

*SET COOKING TIME

1. From the Dehydrate screen, press **Cook Time**. *Figure 3*
2. Use the buttons on the touchpad to select desired cooking time, and press **Set**. *Figure 9*
3. Return to the last screen displayed.
4. If the cooking timer is not populated, the oven will continue to operate at the set temperature.



Figure1



Figure 2



Figure 3



Figure 4



Figure 5

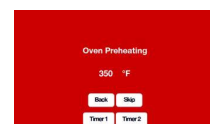

Figure 6

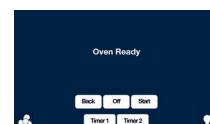

Figure 7



Figure 8



Figure 9



Figure 10

OPERATING THE OVEN

SABBATH

Sabbath mode is intended to allow the oven to be used (subject to various constraints) by Shabbat-observant Jews on the Shabbat and Jewish holidays.

The oven maintains a set cooking temperature for a period of up to 76 hours with the display screen dark and all alarms disabled.

1. Press **Other** on the Main Menu display. *Figure 1*
2. Press **Sabbath** on the **Other** screen. *Figure 2*
3. The oven goes into Bake mode. Press **Set Temp** on the **Sabbath** screen. *Figure 3*
4. Select one of the preset **Bake** temperatures or press **Other** to enter a different temperature. *Figure 4*
 - In Sabbath mode, the oven can operate at temperatures between 150 and 500 degrees F. Entering a temperature outside of this range will result in an error message.
5. If desired, press the **Fan** icon or **Conv Fan** for convection baking, then press **Start**. **Convection Sabbath** will be displayed. See the **TIPS** section for Convection Baking recommendations.
6. If **Other**, enter your desired temperature, then **Start**. *Figure 5*
7. The **Sabbath** screen appears. Press **Start** to activate Sabbath mode.* *Figure 6*

ATTENTION

- When **Start** is pressed, the alarm and control knobs will be disabled, the oven light's On or Off status will be maintained, and the oven will remain in Bake mode for the duration of the Sabbath period.
 - Keeping the oven light on while baking will increase the oven temperature approximately 15 degrees F.
 - Touching the screen will enable all functions. Select **Continue** if you want to extend the Sabbath mode.
8. A black screen is displayed until the Sabbath timer ends. *Figure 7*
 9. When the Sabbath timer expires, the **Sabbath Complete** screen is displayed. Press **Cancel** to return to the Main Menu. *Figure 8*

SET SABBATH DURATION TIME

1. The default time for the Sabbath mode is 76 hours. To change the time period, press **Cook Time** on the Sabbath screen. *Figure 9*
2. Use the buttons on the touchpad to select desired Sabbath time, and press **Set**. *Figure 9*
3. Return to the last screen displayed.
4. If the cooking timer is not populated, the oven will continue to operate at the set temperature.



Figure 1



Figure 2



Figure 3



Figure 4



Figure 5

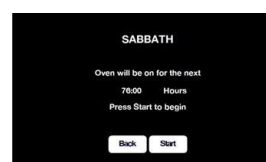

Figure 6



Figure 7

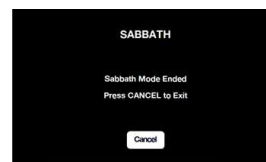

Figure 8



Figure 9

CLEANING

The electric wall oven's eco-friendly Continu Clean™ works every time the oven is on, helping to keep your oven clean without extreme temperatures or harsh cleaning chemicals.

When your oven interior becomes heavily soiled, use the self-cleaning cycle to clean your oven.

TIPS

- Turn on ventilation to remove excess smoke or fumes that might be produced.
- Remove large built-up food particles and grease before starting the Oven Cleaning Cycle.
- Do not use water or other solvents on the Bake Stone to clean.

ATTENTION

- Remove the roast probe from the oven.
- Remove the oven racks and glides. Wash by hand or in the dishwasher.
- The Bake Stone can be left in the oven during the Oven Cleaning Cycle.
- The oven will get hot during the Oven Cleaning Cycle, this includes oven doors.
- Do not touch the oven or open the oven door during the Oven Cleaning Cycle.

WARNING

1. Press **Clean** on the *Main Menu* display. *Figure 1*
2. Press **Start** on the *Oven Cleaning* screen to start the cleaning cycle. *Figure 2*
3. The *Cleaning in Progress* screen will be displayed during the entire cleaning cycle with a countdown timer that starts at 1:30. *Figure 3*
4. When the cleaning cycle is complete, the *Cleaning in Progress* screen will display **Cancel**. An alarm will signal twice and then once every 10 seconds.
5. Press **Cancel** to return to the Main Menu. The oven will still be hot, but is ready for use.
6. Press **Cancel** on the *Cleaning in Progress* screen to stop the cleaning process.

ATTENTION

The oven will be hot if the Oven Cleaning Cycle is cancelled mid-cycle. Do not open or touch the oven doors.



Figure 1



Figure 2



Figure 3



Figure 4

Oven Cleaning

 **WARNING**

- Do NOT apply commercially available oven cleaners to the oven door gasket.
- Do NOT rub or scrub the gasket since it may damage the oven door seal.
- Make sure cleaning chemicals do not come in contact with any stainless steel, painted surfaces.
- Do NOT use steel wool or metal pads to clean the interior oven walls. They may damage or scratch the enamel coating.
- Do NOT apply commercially available oven cleaners, water or solvents to Bake Stone.

 **ATTENTION**

- Make sure the area is well-ventilated when using a commercially available oven cleaner.

Oven Window

- When oven is cool, and after each use, use a cloth and warm soapy water to clean the interior oven door window to reduce baked-on stains. Rinse with clear water and dry thoroughly.
- For tougher stains, use a commercially available oven cleaning product. Follow cleaner manufacturer's instructions.

Interior Oven Walls

- Your oven's interior is coated with porcelain enamel and can be cleaned with commercially available oven cleaners. Follow the cleaner manufacturer's instructions. Do NOT use on door gasket or Bake Stone.
- Do NOT use soap or water on the Bake Stone.

Oven Fan Guard

- Clean the oven fan guard periodically. Keep the fan guard clear of obstructions.
- Apply a commercially available oven cleaner to a cloth to remove grease build-up and food particles. Follow manufacturer's cleaning instructions.

Oven Racks and Guides

- Remove and clean racks and guides in hot, soapy water. Rinse well and dry thoroughly.
- Racks and guides can be cleaned in the dishwasher.

SETTINGS

The Settings screen is used by the technician during installation or service calls to optimize the oven's performance. If you reach this screen by accident, press **Cancel** to return to the previous screen.

CHANGING TEMPERATURE SCALE FROM C TO F, OR F TO C

1. Press **Other** on the Main Menu display. *Figure 1*
2. Press **Settings** on the **Other** display. *Figure 2*
3. Press **Enter Password**. *Figure 3*
4. Enter 12345. *Figure 4*
5. Press F or C located in the top right of the screen.
6. Press **SAVE & EXIT**. *Figure 3*



Figure 1



Figure 2



Figure 3



Figure 4

HYSTERESIS & OFFSETS

The hysteresis setting determines how quickly the oven responds to a change in temperature sensed by the probe. Increasing this number will make the oven react slower while decreasing the number will make it react faster. The factory default and recommended setting is 2.

Oven probe offset allows you to calibrate the center of the oven temperature to the probe location. A number followed by a + will decrease the center oven temperature while a number followed by a – will increase the center oven temperature. The oven is factory calibrated and changes to this setting are not recommended.

Product Probe offset allows you to calibrate the product probe. A number followed by a + will decrease the probe temperature while a number followed by a – will increase the probe temperature. The probe is factory calibrated and changes to this setting are not recommended.

Bottom Bake offset allows you to calibrate the baking stone temperature to the probe location. A number followed by a + will decrease the stone temperature while a number followed by a – will increase the stone temperature. The oven is factory calibrated and changes to this setting are not recommended.

CARE AND CLEANING



Make sure the oven is cool before cleaning.

PART/ MATERIAL	CLEANING	FREQUENCY	ATTENTION
Convection Fan Guard / Porcelain Enamel	Remove obstructions like aluminum foil or other particles. Apply commercial oven cleaner to a cloth and wipe the guard. Follow manufacturer's instructions.	Once a month; more often with frequent use.	Turn on ventilation fan and make sure room is well vented. Do NOT use steel wool, metal pads or abrasive cleaners. They may scratch and damage the coating. Line floor with newspaper to catch drips.
Exterior Body / Standard RAL Colors	Clean with hot, soapy water. Rinse well and dry thoroughly. For tough stains, apply a cloth soaked in hot water for several minutes. Scrape LIGHTLY with a nylon or rubber spatula.	As needed	Do NOT use steel wool, metal pads or abrasive cleaners. Do NOT use any metal objects to scrape the surface. Do NOT allow citrus or tomato juices to sit and dry on the surface. Citric acid will discolor stainless steel.
Exterior Body / Stainless Steel	Clean with hot, soapy water. Rinse well and dry thoroughly. For tough stains, use a commercial stainless steel cleaner and follow the cleaning manufacturer's instructions.	As needed	Do NOT use steel wool, metal pads or abrasive cleaners. Do NOT use any metal objects to scrape the surface. Do NOT allow citrus or tomato juices to sit and dry on the surface. Citric acid can discolor stainless steel.
Exterior Body / Textured Paint	Clean with hot, soapy water. Rinse well and dry thoroughly. For tough stains, apply a cloth soaked in hot water for several minutes. Scrape LIGHTLY with a nylon or rubber spatula. Repeat body stainless section – be gentle when scrubbing textured paint	As needed	Do NOT use steel wool, metal pads or abrasive cleaners. Do NOT use any metal objects to scrape the surface.

			Do NOT allow citrus or tomato juices to sit and dry on the surface. Citric acid will discolor stainless steel.
Display Screen	Use damp microfiber or soft cotton cloth; wipe dry		Lock the display screen before cleaning to prevent the oven from operating.
			Turn on ventilation fan and make sure room is well vented.
			Do NOT apply commercial oven cleaners to the oven door gasket.
Oven Interior / Porcelain Enamel	Use a commercially available oven cleaner. Follow cleaner manufacturer's instructions.	Once a month; more often with frequent use.	Do NOT rub or scrub the gasket. This may damage the oven door seal. Do NOT use steel wool, metal pads or abrasive cleaners. They may scratch and damage the coating. Do NOT use soap or water on the Bake Stone.
Oven Racks and Guides	Remove and wash in hot, soapy water. Rinse well and dry thoroughly. Dishwasher safe.	Once a month; more often with frequent use.	
Bake Stone	After the stone is cool, use a nylon scraper or dry cloth to remove crumbs or baked on residue.	After each use.	Never use an abrasive sponge or brush. Never immerse the stone in any liquid. Do NOT use soap or water on the Bake Stone. Do NOT use commercially available cleaning products on the Bake Stone. The stone will darken in color with use. The stone may darken unevenly based on use. This is normal.

BEFORE CALLING FOR SERVICE

Check these helpful tips for any problems with your range. If you need additional help call BlueStar® Customer Service at 800 449-8691.

PROBLEM	POSSIBLE CAUSE	SOLUTION
Display Screen not lit	Sabbath mode No electrical power to the unit.	Cancel Sabbath mode Check if the breaker/fuse is tripped. Reset breaker. Call for service if it occurs more than once during a backing cycle.
Convection fan does not turn	No electrical power to the unit. Fan guard is obstructed or clogged.	Plug into a three-prong electrical outlet that is properly grounded. Check and re-set circuit breaker for the unit. When oven is cool, remove any obstructions like baked-on food or aluminum foil. Call for service.
Unit is on, but no heat is being produced.	Breaker may not be fully seated.	Make sure that the breaker is fully seated in the <i>on</i> position. If issue continues, call for service. Turn unit off at the breaker.
Oven light not on	No electrical power to the unit. Oven light bulb burned out.	Check and re-set circuit breaker for the wall outlet used for the unit. Replace with 25 watt halogen G9 light bulb only. See Replacing Oven Bulb instructions on page 42.
Display screen text appears blurry.	Software disruption	Cycle (turn on & off) the electrical breaker connected to the electric wall oven.
Convection Fan making noise	Aluminum foil or other material stuck in fan Mounting screws of fan cover are loose Fan cover is bent	Make sure oven of cool and fan if off, then remove debris. Tighten screws Call for replacement fan cover.
Fan (behind control panel) is running when oven is turned off	Oven has not cooled to 200 degrees F or below.	Let oven cool down.
Oven is cool and Fan (behind control panel) is running	Fan relay stuck in the on position.	Cycle (turn on & off) the electrical breaker connected to the electric wall oven.

MAINTENANCE

Oven Light Bulb Replacement

ATTENTION

- Only use a 25 watt halogen G9 light bulb. Regular light bulbs cannot tolerate oven temperatures.

To replace your oven light bulb:

1. Make sure appliance and lights are cool, and power has been turned off before replacing light bulb.
2. Remove glass cover, pull out blub out, push new bulb in, replace and press glass cover back in place

ATTENTION

- Hold replacement light bulb with a dry cloth, do not let hands make contact with light bulb. Oils from skin can shorten replacement light bulb life. If you do touch bulb, clean with rubbing alcohol before use.

Oven Doors

The oven door hinges may require lubrication periodically to work smoothly. Whether this is necessary, or how frequently, depends on how and how often the oven is used.

- Open the oven door fully and apply a small amount of lubricant such as food-grade light oil or grease to the ball visible in the hinge slot on your door.

ATTENTION

Do NOT use sprays like WD-40 or CRC that may get onto the oven door surface. We recommend a food-grade light oil or grease. Avoid using cooking oil or mineral oil.

ELECTRICAL REQUIREMENTS

The Electrical Appliance Rating:

240V/ 60 hertz, 24 amp, recommended 30 Amp circuit for single oven, 50 Amp circuit for stacked ovens

Effective January 1, 1996 the National Electrical Code requires that new, but not existing construction utilize a four-conductor connection to an electric oven. For existing construction you must use a three-wire, single phase A.C. electrical system. If you connect to aluminum wiring, properly installed connectors approved for use with aluminum wiring must be used.

Oven will function properly on 208V power. Preheat will be slightly extended, but once preheat is complete no other performance will be impacted.

PERFORMANCE CHECKLIST

This checklist has been developed to assure proper installation of your appliance.

To validate your warranty you must mail or fax this form within 90 days of installation, with a copy of your receipt to: Warranty Department, Prizer-Painter Stove Works Inc., 318 June Avenue Blandon, PA 19510 or email service serviceteam@bluestarcooking.com.

Customer Information (Please Print)

Name: _____

Address: _____

City: _____

State, Zip Code: _____

E-mail: _____

Telephone: _____

Dealer: _____

Product Information (Please Print)

Model No: _____

Serial No: _____

Purchase Date: _____

Installation Date: _____

Installer's Name: _____

Company: _____

Telephone: _____

CHECK ALL THAT APPLY

Appearance and Aesthetics

- Exterior
- Oven interior

Installation

- Proximity to cabinets
- Level
- Ventilation system
- Read User Manual
- Review safety instructions

Controls

- Quick control knobs
- Thermostats
- Convection oven fan & operation
- Oven light operation
- Display screen

Electrical Connection

- Correct voltage
- Grounded outlet
- No GFCI

Heating Elements Function

- Oven Burner
- Infrared Broiler

Oven Door

- Alignment
- Door seal
- Hinges

LIMITED WARRANTY

BlueStar® Cooking Appliances, BlueStar® Ventilation Hoods, Prizer Hoods® Ventilation Hoods and Abbaka Ventilation hoods and remote blowers

Before using your Product, please read this Limited Warranty and Arbitration Clause carefully to understand your rights.

This Warranty is provided to you by Prizer-Painter Stove Works, Inc. (“Prizer-Painter”), which warrants the parts of your BlueStar® cooking appliance, BlueStar® ventilation hood, Prizer Hoods® ventilation hood, or Abbaka ventilation hood or remote blower (“Product”), as described below.

This Warranty covers the owner of the residence in which the Product is installed, and his or her spouse (“Owner” or “You”).

Products Covered

This Warranty applies only to BlueStar® cooking appliances, BlueStar® ventilation hoods, Prizer Hoods® ventilation hoods and Abbaka ventilation hoods and remote blowers purchased in the continental U.S. and Canada on or after April 1, 2019. This Warranty applies only to Product sold by a BlueStar® authorized dealer or Prizer-Painter directly for use in residential properties only. Products must be installed by a qualified, licensed installer. Any service call deemed to be the result of improper installation shall be the responsibility of the owner. This Warranty is also void if the original factory installed serial number is altered or removed from the Product.

Products Not Covered

This Warranty does not apply to Products installed or used in any commercial or other non-residential property such as, but not limited to, day care facilities, hotels, motels, firehouses and nursing homes. This Warranty does not cover Products installed outside the U.S. or Canada. This Warranty does not apply to gas type conversions on cooking appliances not completed by a certified gas technician, licensed plumber or certified BlueStar® servicers.

Full Two-Year Warranty

Product Registration is not required to obtain Warranty Coverage but is highly recommended for optimal servicing and affects the length and certain remedies available under the warranty.

If the Product is properly registered within 90 days of Installation Date: For two (2) years from the date that the Product is originally installed, this Warranty covers all parts and labor to repair or replace, at our discretion, any functional component of the Product, that is defective in materials or workmanship. Replacement service will only be provided if and when attempts to repair the Product have been exhausted. Such repair or replacement service must be performed by a factory authorized service agent located within 100 miles roundtrip from the location of the Product. Service will be provided during normal business hours. The Owner will be responsible for any and all costs associated with additional mileage, non-standard service or overtime, and special equipment required to remove the Product so that service may be performed. Prizer-Painter reserves the right to deny warranty coverage for excessive installation delays.

For products not properly registered: For one (1) year from the date that the Product is originally installed, this Warranty covers all parts and labor to repair or replace, at our discretion, any functional component of the Product, that is defective in materials or workmanship. Replacement service will only be provided if and when attempts to repair the Product have been exhausted. Such repair or replacement service must be performed by a

factory authorized service agent located within 100 miles roundtrip from the location of the Product. Service will be provided during normal business hours. The Owner will be responsible for any and all costs associated with additional mileage, non-standard service or overtime, and special equipment required to remove the Product so that service may be performed. Prizer-Painter reserves the right to deny warranty coverage for excessive installation delays.

Limited Cosmetic Component Warranty: This Warranty covers the repair or replacement of all cosmetic component flaws for thirty (30) calendar days from the date of delivery of the Product to the owner's home from a BlueStar[®] authorized dealer. Cosmetic components include top grates, ring grates, plate rail, kick panel, body sides, glass, control panel, door panel, back guards, oven seals, front sides of hoods, and hoods strapping. Cosmetic components flaws include visible chips, scratches, dents, provided, however, that cosmetic flaws caused by freight damage are excluded.

Limited Warranty on Floor Models Not Used For Demonstration: Floor Models are covered by a one (1) year limited functional parts and related services warranty, with proof of date of installation. There is no cosmetic warranty of any kind for floor models.

Limited Warranty on Floor Models Used For Demonstration: Floor Models used for demonstration are covered by a ninety (90) day limited parts warranty only, with proof of date of installation. There is no service or cosmetic warranty of any kind for floor models.

Limited Warranty on Product Refurbished

Refurbished Products are covered by a six (6) months limited functional parts and labor warranty, with proof of installation, as well as an additional six (6) months limited parts warranty. There is no cosmetic warranty of any kind on Refurbished Product.

Registration

Registration is strongly recommended. While not necessary to effectuate warranty coverage, it is the best way for Prizer-Painter to communicate with you about important events and also provides additional warranty coverage. TO REGISTER, please fill out the "Performance Checklist and Warranty Form" located online at www.bluestarcooking.com/support/product-registration. Or mail the form located in the back of the Product Use and Care Manual to: Warranty Department, Prizer-Painter Stove Works, 318 June Avenue, Blandon, PA 19510-9566.

Obtaining Warranty Service

If a Warranty claim is not submitted as required, such claim will be invalid and will not be honored.

To obtain Warranty service, where applicable, the Owner must call the Service Center (toll free: 1-800-449-8691) or fill out the online form at www.bluestarcooking.com/service to report a warranty claim, and may be required to, at the time, provide (1) the model number of the Product, (2) the serial number of the Product, (3) proof of delivery, (4) a signed installation receipt, (5) a description of the claimed defect, and (6) proof of purchase of the Product, including the original retail receipt or invoice to establish the Warranty Period. Prizer-Painter must be given an opportunity to inspect any Product subject to a warranty claim. All warranty related service repairs must be performed by a factory authorized service agent.

This Limited Warranty gives you specific legal rights, and you may also have other rights that may vary from state to state or province to province.

Out of Warranty Product

Prizer-Painter is under no obligation, at law otherwise, to provide you with any concessions, including repairs, pro-rates or Product replacement, once this warranty has expired.

What Is Not Covered

This Warranty does not cover, and specifically excludes:

- Damages caused by shipping.
- Damage or repairs to the porcelain igniters, calibrations and normal adjustments after installation and setup, including burner adjustments.
- Normal wear and tear, care, and maintenance of the Product as described in the installation and operating manual, such as cleaning of parts, discoloration of the griddle, rust, gasket materials, ceramic materials, and fuses.
- Damage or repairs caused by alterations or modifications, abuse, excessive force, misuse, neglect, or improper installation, instruction, handling, operation, maintenance or storage.
- Accidental or intentional damage.
- Damage or repairs caused by unauthorized or improper service or repairs.
- Damages or repairs as a result of natural disasters, fires, floods, earthquakes, winds, lightning, corrosive atmosphere, loss of electrical power to the Product for any reason, or other conditions beyond Prizer-Painter's control.
- Damage or repairs caused by alteration for outdoor use.
- Damage or repairs caused by the use of harsh chemicals or cleaning products improperly applied.
- Discolorations to backguards from use of griddle or burners.
- The replacement of a part or Product under this Warranty does not extend the Warranty period.
- If the Product is removed from the property where it was originally installed .
- Slight color variations may be noticed because of differences in painted parts, kitchen lighting, product placement, and other factors; this warranty does not apply to color variations.
- Service calls to educate the customer on proper use and care of the product.
- Failure of the product when used for commercial, business, rental or any application other than for residential consumer use.
- Liability or responsibility for damage to surrounding property including cabinetry, floors, ceilings and other structures or objects around the Product.
- Consequential or incidental damage, including but not limited to food or medicine loss, time away from work or restaurant meals.

This warranty is in lieu of all other express warranties. No employee or representative of Prizer-Painter is authorized to make any modification, extension or addition to this Limited Warranty.

ALL IMPLIED WARRANTIES, INCLUDING BUT NOT LIMITED TO WARRANTIES OF MERCHANTABILITY AND FITNESS FOR PARTICULAR PURPOSE ARE LIMITED TO THE DURATION OF THIS WARRANTY. Some states and provinces do not allow limitations on implied warranties, so the above limitation may not apply to you.

THE OWNER AND PRIZER-PAINTER AGREE THAT THE REMEDIES SET OUT HEREIN ARE THE OWNER'S EXCLUSIVE REMEDIES FOR BREACH OF ALL WARRANTIES, EXPRESS OR IMPLIED.

WHETHER ANY CLAIM IS BASED ON NEGLIGENCE OR OTHER TORT, BREACH OF WARRANTY OR BREACH OF CONTRACT, OR ANY THEORY, PRIZER-PAINTER SHALL IN NO EVENT BE LIABLE FOR INCIDENTAL, CONSEQUENTIAL OR SPECIAL DAMAGES,

INCLUDING BUT NOT LIMITED TO DAMAGES FOR EXPENSES, SUCH AS, EXTRA UTILITY EXPENSES, SHIPPING COSTS RELATED TO REPAIR OR REPLACEMENT OF ANY PRODUCT OR DAMAGES TO PROPERTY, RESULTING FROM BREACH OF THIS WARRANTY OR ANY IMPLIED WARRANTY. Some states and provinces do not allow the exclusion or limitation of incidental or consequential damages, so these provisions may not apply to you.

Where Can Any Legal Remedies Be Pursued

Please see the Arbitration Clause and Related Provisions, which affect your legal rights. [Read this Arbitration Clause](#) and its related provisions carefully. The Arbitration Clause is also available on Prizer-Painter's website.

ARBITRATION CLAUSE

BlueStar® Cooking Appliances, BlueStar® Ventilation Hoods, Prizer Hoods® Ventilation Hoods and Abbaka Ventilation Hoods and remote blowers

ARBITRATION CLAUSE. IMPORTANT. PLEASE REVIEW THIS ARBITRATION CLAUSE. IT AFFECTS YOUR LEGAL RIGHTS. YOU SHOULD ALSO CONSIDER CONSULTING WITH OTHERS ABOUT ARBITRATION BECAUSE THE INFORMATION PROVIDED IS NOT INTENDED TO CONTAIN A COMPLETE EXPLANATION OF THE CONSEQUENCES OF ARBITRATION.

1. **Parties:** This arbitration clause affects your rights against Prizer-Painter Stove Works, Inc. and any of its affiliates or employees or agents, successors, or assigns, all of whom together are referred to as “we” or “us” for ease of reference.
2. **ARBITRATION REQUIREMENT: EXCEPT AS STATED BELOW, ANY DISPUTE BETWEEN YOU AND ANY OF US SHALL BE DECIDED BY NEUTRAL, BINDING ARBITRATION RATHER THAN IN COURT OR BY JURY TRIAL.** “Dispute” will be given the broadest possible meaning allowable by law. It includes any dispute, claim, or controversy arising from or relating to your purchase of a Prizer-Painter Product, any warranty upon the unit, or the unit’s condition. The arbitrator(s) shall have the exclusive power and jurisdiction to make all procedural and substantive decisions concerning the Dispute including the power to determine the question of arbitrability including the scope or applicability of this Arbitration Clause. The arbitration requirement applies to all claims including those arising out of contract and tort, pursuant to statute, or otherwise.
3. **CLASS-ARBITRATION WAIVER: ARBITRATION IS HANDLED ON AN INDIVIDUAL BASIS. IF A DISPUTE IS ARBITRATED, YOU AND WE EXPRESSLY WAIVE ANY RIGHT TO PARTICIPATE AS A CLASS REPRESENTATIVE OR CLASS MEMBER ON ANY CLASS CLAIM YOU MAY HAVE AGAINST US, AND US AGAINST US, OR AS A PRIVATE ATTORNEY GENERAL OR IN ANY OTHER REPRESENTATIVE CAPACITY. YOU AND WE ALSO WAIVE ANY RIGHT TO CLASS ARBITRATION OR ANY CONSOLIDATION OF INDIVIDUAL ARBITRATIONS.**
4. **Discovery and Other Rights:** Discovery and rights to appeal in arbitration are generally more limited than in a lawsuit. This applies to both you and us. Other rights that you or we would have in court may not be available in arbitration. Please read this Arbitration Clause and consult the rules of the arbitration organizations listed below for more information.
5. **SMALL CLAIMS COURT OPTION: YOU MAY CHOOSE TO LITIGATE ANY DISPUTE BETWEEN YOU AND ANY OF US IN SMALL CLAIMS COURT, RATHER THAN IN ARBITRATION, IF THE DISPUTE MEETS ALL REQUIREMENTS TO BE HEARD IN SMALL CLAIMS COURT.**
6. **OPTING OUT OF THIS ARBITRATION CLAUSE: YOU MAY OPT OUT OF THIS ARBITRATION CLAUSE WITHIN 60 DAYS OF WHEN WARRANTY COVERAGE BEGINS, IF YOU INFORM PRIZER-PAINTER IN WRITING, VIA REGISTERED MAIL (SENT TO PRIZER-PAINTER CONSUMER AFFAIRS , Prizer-Painter Stoveworks, 318 June Avenue Blandon, PA 19510-9566. THAT YOU ARE OPTING OUT.** Please also provide your name, address, product model and serial number and proof of purchase. There is no other procedure to opt out. Opting out of this Arbitration Clause will not affect your other rights under this warranty.
7. **Governing Law:** The procedures and effect of the arbitration clause will be governed by the Federal

Arbitration Act (9 U.S.C. § 1 *et seq.*) rather than by state law concerning arbitration. The law governing your substantive warranty rights and other claims will be the law of the state in which you purchased your Prizer-Painter Product. Any court having jurisdiction may enter judgment on the arbitration award.

8. **Rules of the Arbitration:** If the amount in controversy is less than \$50,000, the arbitration will be decided by a single arbitrator to be appointed according to the rules of the arbitration association that is chosen. If the amount in controversy is greater than or equal to \$50,000, the arbitration will be decided by a panel of three arbitrators. The arbitrator(s) will be chosen pursuant to the rules of the administering arbitration organization. You may choose either of the following arbitration organizations, and its applicable rules: the American Arbitration Association, 1633 Broadway, 10th Floor, New York, NY 10019 (www.adr.org), JAMS, 1920 Main Street, Ste. 300, Irvine, CA 92614 (www.jamsadr.com), or any other organization that you may choose subject to our approval. These organizations' rules can be obtained by contacting the organization or visiting its website. If the chosen arbitration organization's rules conflict with this Arbitration Clause, the provisions of this Arbitration Clause control. The award of the arbitrator(s) shall be final and binding on all parties.

9. **Location of the Arbitration Hearing:** Unless applicable law provides otherwise, the arbitration hearing will be conducted in the federal judicial district in which you reside.

10. **Costs of the Arbitration:** Each party is responsible for its own attorney, expert and other fees, unless awarded by the arbitrator(s) under applicable law. Prizer-Painter will pay your share of the fees charged by the arbitration organization and arbitrator(s) beyond the first \$200. Where permissible by law, you may be required to reimburse Prizer-Painter for the fees of the arbitration organization and arbitrator(s) in whole or in part by decision of the arbitrator(s) at the discretion of the arbitrator(s).

11. **Survival and Enforceability of this Arbitration Clause:** This Arbitration Clause shall survive the expiration or termination, or any transfer, of the warranty on your unit. If any part of this Arbitration Clause, except waivers of class-action rights, is found to be unenforceable for any reason, the remainder shall remain enforceable. If, in a case in which class-action allegations have been, a waiver of class-action rights is found to be unenforceable with respect to all or some parts of a dispute, the remainder of this Arbitration Clause shall be unenforceable as those parts. Instead, those parts will be severed and proceed in court, with the remaining parts proceeding in arbitration.

12. **Confidentiality.** The arbitrator(s), Prizer-Painter and Owner will maintain confidentiality of the proceedings including but not limited to all information gathered, prepared and presented for purposes of the arbitration relate to the Dispute.

13. **Informal Process to Resolve Disputes.** Our goal is to resolve claims fairly and quickly. For any Dispute that You have against Prizer-Painter, you agree to first contact Prizer-Painter and attempt to resolve the claim informally by sending written notice of your claim by email to legal@bluestarcooking.com. The notice must include (a) your name, address, email address and mobile telephone number; (b) describe the nature and basis of the Dispute; and (c) set forth the specific relief being sought. If You and Prizer-Painter cannot reach an agreement within thirty (30) days after such notice is received, then either party may submit this Dispute to binding arbitration as set forth above or where applicable to small claims court.