

24" Scoop Handle Dishwasher

300 Series – White SHS53CM2N

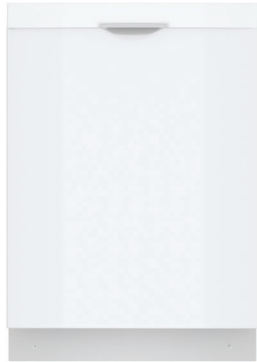

SHS53CM2N
White

Also available in:

Stainless Steel SHS53CM5N

The 3rd rack provides the perfect space for silverware and large utensils while its V shape leaves room below for taller items.

Features & Benefits

So quiet at 46 dBA, InfoLight® shines on the floor so you know the dishwasher is running.

With PrecisionWash®, intelligent sensors and precision spray arms target every item of every load, so dishes come out sparkling clean every time.

Enhance your cleaning experience with Wi-Fi enabled Home Connect®. Access additional wash cycles and options or choose the right one for your needs using Smart Cycle.

General Properties	
Number of wash cycles	5 + 3 additional in Home Connect®
Number of options	3 + 2 additional in Home Connect®
dBA	46
Wash system	PrecisionWash®
Drying system	PureDry®
Third rack	Standard 3rd Rack
Rack adjustability	Rackmatic®
Tub material	Stainless Steel
Control type	Touch Controls
Concealed water heating element	Yes
Leak protection system	24/7 AquaStop®
Home Connect® (WiFi enabled)	Yes
NSF®-certified* sanitize option	Yes
Water softener	No
Five-level wash	Yes
Child Lock button suspension	No
Anti-Fingerprint Finish	N/A
Special features	InfoLight®, Extra Dry Option
Efficiency	
Water usage per cycle	3.5 gal
ENERGY STAR® certified	No
Total annual energy consumption	269 kWh
Capacity	
Number of place settings	16



Technical Details	
Watts	1440 W
Current	12 Amps
Volts	120 V
Frequency	60 Hz
Power cord full length	67"
Power cord install length from edge of unit when facing the door	Left – 45" Right – 56"
Minimum water pressure	14 lb/sin
Length outlet hose	78 3/4"

Dimensions & Weight

Overall appliance dimensions (HxWxD)	33 7/8" x 23 9/16" x 23 3/4"
Required cutout size (HxWxD)	33 7/8" x 24" x 24"
Adjustable feet	Yes
Net weight	81 lbs

Accessories—Optional

Junction Box	SMZPCJB1UC
Junction Box + Supply Hose Kit	SMZ3IN1UC
Bosch Dishwasher Water Supply Hose	SMZSH1ABUC
Drain Hose Extension Kit	SGZ1010UC
Dishwasher Accessory Kit	SMZ5000
Anti-Tarnish Silverware Cassette	SMZ5002UC
Edge Protector + Power Cord Clip Install Kit	SMZEPCC1UC

*Certification to NSF/ANSI Standard 184 for residential dishwashers

Accessories: To purchase Bosch accessories, cleaners & parts please call 1-800-944-2904 (Mon to Fri 5 am to 6 pm PST, Sat 6 am to 3 pm PST).

Notes: All height, width and depth dimensions are shown in inches. BSH reserves the absolute and unrestricted right to change product materials and specifications, at any time, without notice. Consult the product's installation instructions for final dimensional data and other details prior to making cutout.

Warranties: Please see Use & Care manual or Bosch website for statement of limited warranty.

For more information on our entire line of products, go to www.bosch-home.ca or call 1-800-944-2904

© BSH Home Appliances Corporation. All rights reserved. Bosch is a registered trademark of Robert Bosch GmbH.

24" Scoop Handle Dishwasher

300 Series – White SHS53CM2N



Installation Details

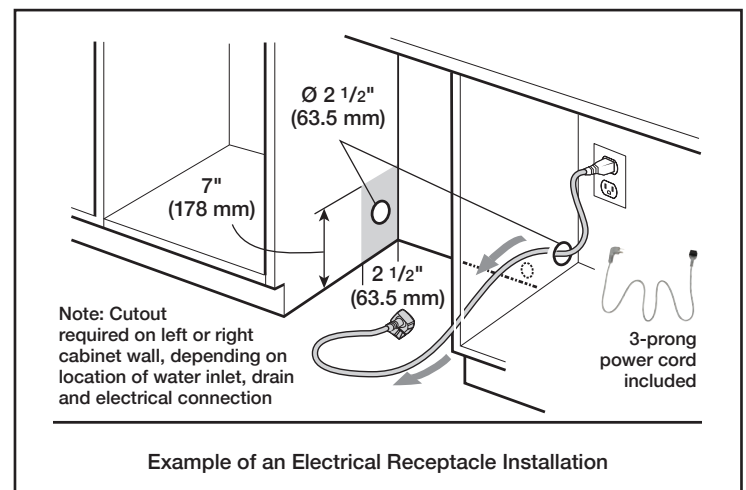
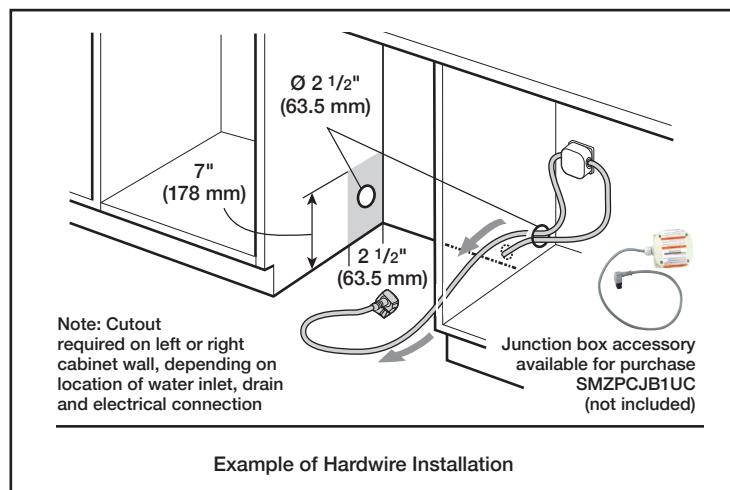
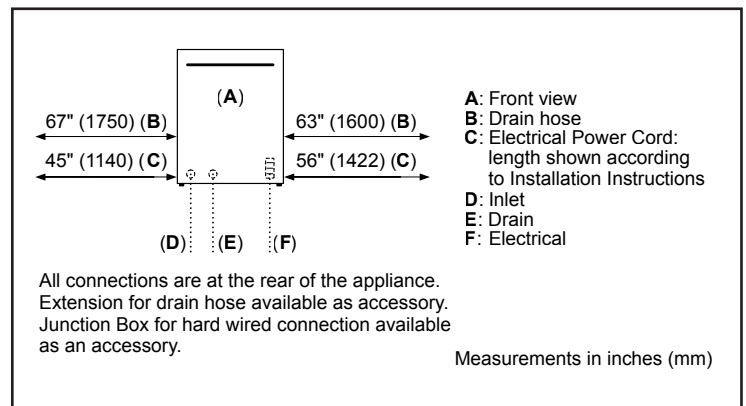
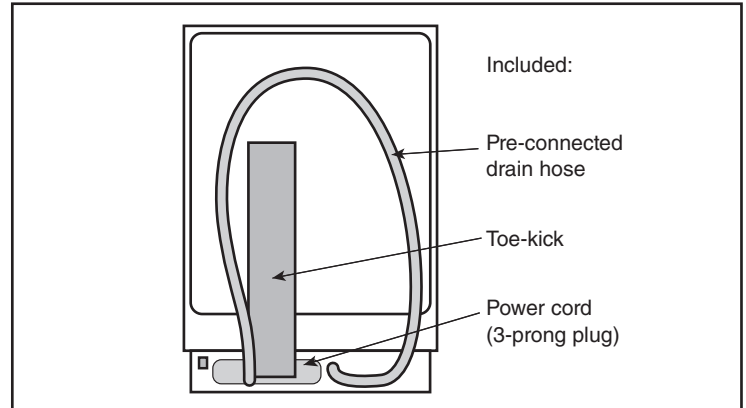
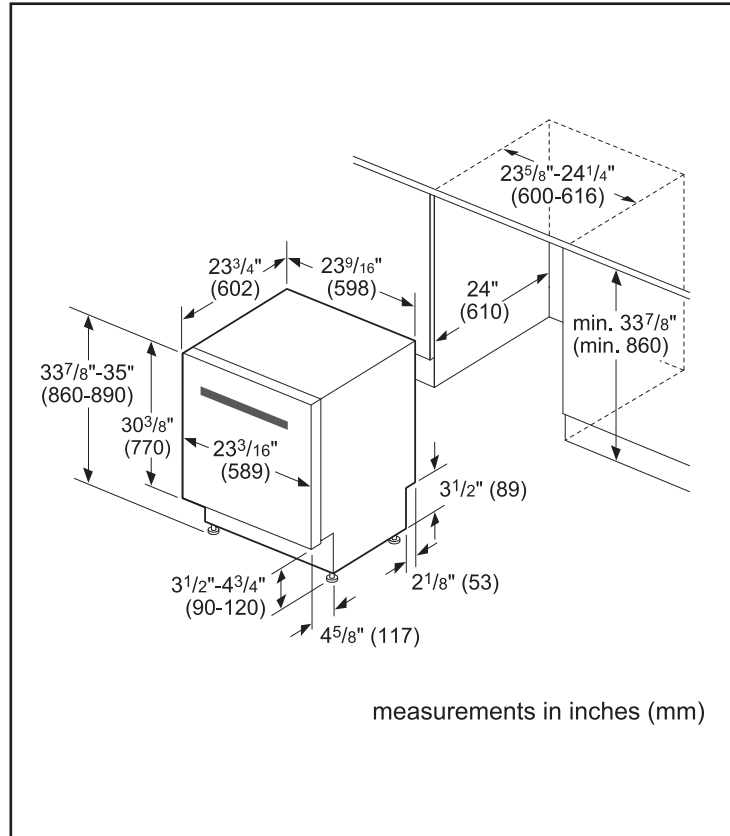

Accessories: To purchase Bosch accessories, cleaners & parts please call 1-800-944-2904 (Mon to Fri 5 am to 6 pm PST, Sat 6 am to 3 pm PST).

Notes: All height, width and depth dimensions are shown in inches. BSH reserves the absolute and unrestricted right to change product materials and specifications, at any time, without notice. Consult the product's installation instructions for final dimensional data and other details prior to making cutout.

Warranties: Please see Use & Care manual or Bosch website for statement of limited warranty.

For more information on our entire line of products, go to www.bosch-home.ca or call 1-800-944-2904

© BSH Home Appliances Corporation. All rights reserved. Bosch is a registered trademark of Robert Bosch GmbH.

24" Scoop Handle Dishwasher

300 Series – White SHS53CM2N



BOSCH

Invented for life



Installation Details

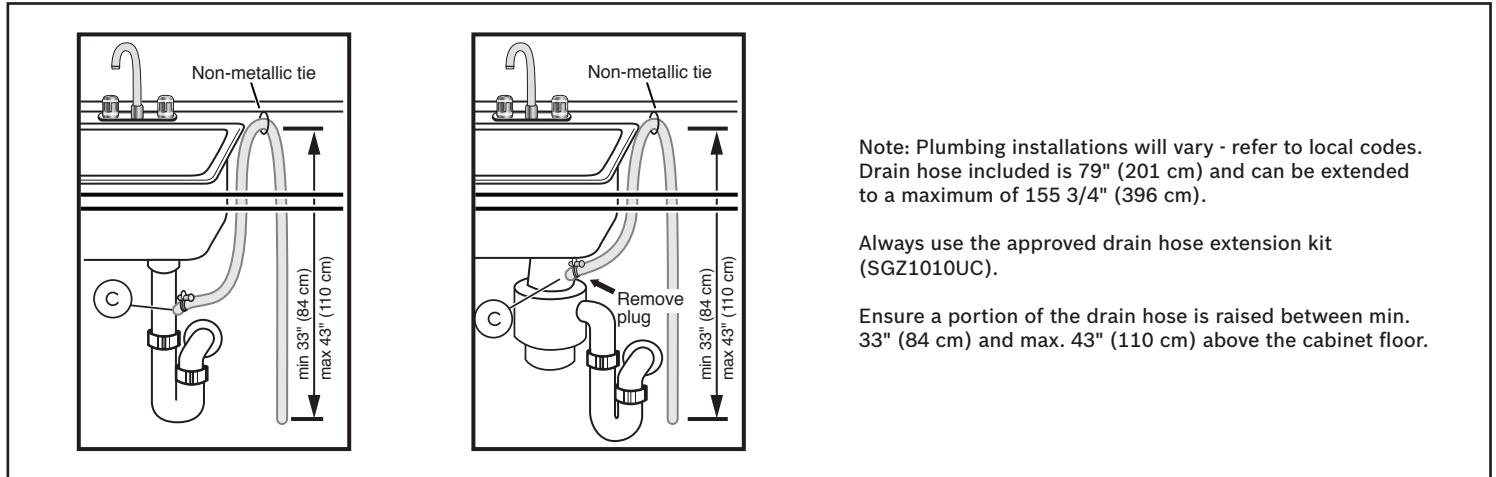

Accessories: To purchase Bosch accessories, cleaners & parts please call 1-800-944-2904 (Mon to Fri 5 am to 6 pm PST, Sat 6 am to 3 pm PST).

Notes: All height, width and depth dimensions are shown in inches. BSH reserves the absolute and unrestricted right to change product materials and specifications, at any time, without notice. Consult the product's installation instructions for final dimensional data and other details prior to making cutout.

Warranties: Please see Use & Care manual or Bosch website for statement of limited warranty.

For more information on our entire line of products, go to www.bosch-home.ca or call 1-800-944-2904

© BSH Home Appliances Corporation. All rights reserved. Bosch is a registered trademark of Robert Bosch GmbH.

7/23 CA