

30" Gas Freestanding Range

300 Series - White

HGS3023UC



Features and Benefits

Key Features

- Five Burner Gas Ranges - Offers the Maximum Burner Performance and Ultimate Cooking Flexibility.
- PowerBoil - Quick Heating with Powerful 16,000 BTU

Design

- Design Fits to Bosch Family Look.
- Recommended Companion to Ascenta Dishwasher, or other Bosch 300 Series Products.
- Available in Black, White and Stainless Steel

Performance

- PowerBoil - Quick Heating with Powerful 16,000 BTU
- 500 BTU Simmer Burner -Easily Heat Delicate Sauces without Scorching or Burning.
- Five Burner Gas Ranges - Offers the Maximum Burner Performance and Ultimate Cooking Flexibility.

Convenience

- Two Racks and Six Different Rack Positions Adjust for All Cooking Needs.
- Continuous Grates - Effortlessly Move Pots and Pans. Easy to Clean
- Sealed Burners - Provide Excellent Cleanability in Case of Spill Overs.
- Self Clean Cycle Saves Time. Quickly and Easily Cleans your Oven.
- Wide View Oven Window - Extra large Window Provides Easy Viewing of Your Food.
- True Hidden Bake Element

Capacity

- Large Cavity with 5.0 cu ft. Easily Accommodates Large Dishes and Offers Multiple Rack Cooking.

Notes: All height, width and depth dimensions are shown in inches. *Please refer to installation instructions prior to making cutout. BSH reserves the absolute and unrestricted right to change product materials and specifications, at any time, without notice. Consult the product's installation instructions for final dimensional data and other details. Applicable product warranty can be found in a accompanying product literature or you may contact your account manager for further details.

For more information on our entire line of products, go to boschappliances.com or call 1-800-944-2904.
Copyright ©2014 BSH Home Appliances Corporation. All rights reserved. Bosch is a registered trademark of Robert Bosch GmbH.

Litho Date: 03/2014



30" Gas Freestanding Range 300 Series - White HGS3023UC

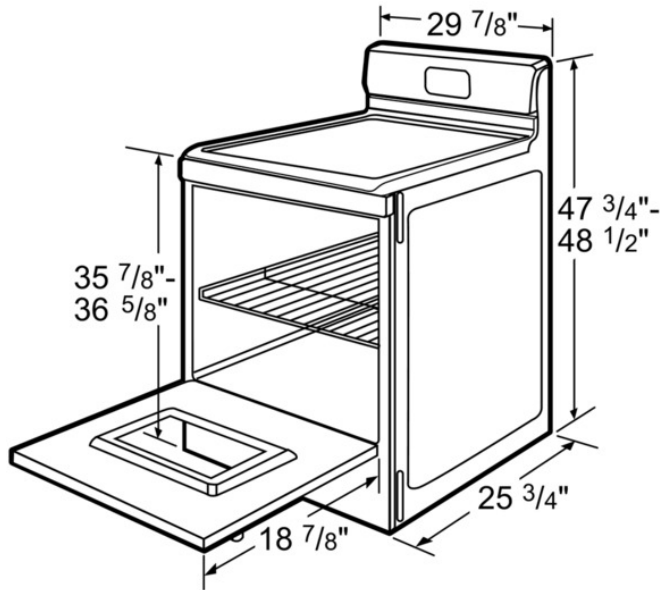

Dimensions in inches

Features

Total number of cooktop burners	5
Cooking method primary cavity	Half width variable grill, Selfcleaning pyrolytic, Top/bottom heat
Cleaning system - primary cavity	Self Clean
Oven Control	electrical
Knob Material	Plastic
Included accessories	2 x grid
Sealed Burners	Yes
Number of Double grates	3
Bake Element Wattages primary cavity (W)	5270
Broil Element Wattages primary cavity (W)	
Convection Element Wattages primary cavity (W)	
Number of gas burners	5
Location of 1st heating element	front left
Power of 1st burner (BTU)	9500
Location of 2nd heating element	back left
Power of 2nd burner (BTU)	12000
Location of 3rd heating element	middle back
Power of 3rd burner (BTU)	9500
Location of 4th heating element	back right
Power of 4th burner (BTU)	5000
Location of 5th heating element	front right
Power of 5th burner (BTU)	16000
Location of 6th heating element	
Power of 6th burner (BTU)	
Power of griddle element	
Display	7-segment, red
Safety device	Thermostat

Technical Specification

UPC code	825225880370
Product color	White
Gas type	Natural gas 15 mbar (USA)
Alternative gas type	Liquid gas 27,5 mbar (USA)
Total BTU load	70000
Watts (W)	1800
Current (A)	15
Volts (V)	120
Frequency (Hz)	60
Approval certificates	CSA, UL
Required cutout size (HxWxD) (in)	30" width slide-in
Overall appliance dimensions (HxWxD) (in)	47 3/4" x 29 7/8" x 25 3/4"
Variable cooker height (in)	3/4"

Notes: All height, width and depth dimensions are shown in inches. *Please refer to installation instructions prior to making cutout. BSH reserves the absolute and unrestricted right to change product materials and specifications, at any time, without notice. Consult the product's installation instructions for final dimensional data and other details. Applicable product warranty can be found in a accompanying product literature or you may contact your account manager for further details.

For more information on our entire line of products, go to boschappliances.com or call 1-800-944-2904.
Copyright ©2014 BSH Home Appliances Corporation. All rights reserved. Bosch is a registered trademark of Robert Bosch GmbH.

Litho Date: 03/2014

