

24" Pocket Handle Dishwasher

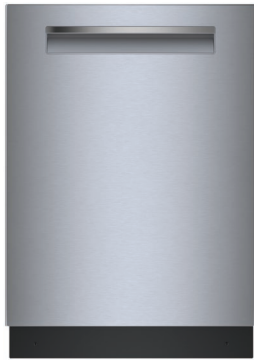

500 Series – Stainless Steel SHP55DM5N



SHP55DM5N
Stainless Steel

Zone Wash creates an intensive wash focus area, allowing you to wash your challenging dishes and pots with confidence

Features & Benefits

The 3rd rack provides the perfect space for silverware and large utensils while its V shape leaves room below for taller items.

So quiet at 46 dBA, InfoLight® shines on the floor so you know the dishwasher is running.

Enhance your cleaning experience with Wi-Fi enabled Home Connect®. Access additional wash cycles and options or choose the right one for your needs using Smart Cycle.

The Favorite button allows you to easily access your preferred cycle/option combination with 1 touch.

General Properties	
Wash cycles (control panel)	5 (Deep Clean, Auto, Normal, Speed60 (1hr Wash), Favorite)
Additional wash cycles (in Home Connect®)	4 (Delicate, Express, Rinse, MachineCare)
Options (control panel)	3 (Sanitize, Remote Start, ExtraDry)
Additional options (in Home Connect®)	3 (Half Load, Eco, Zone Wash)
dBA	46
Wash system	Zone Wash
Drying system	PureDry®
Third rack	Standard 3rd Rack
Rack adjustability	Rackmatic®
Tub material	Stainless Steel
Concealed water heating element	Yes
Leak protection system	24/7 AquaStop®
Home Connect® (Wi-Fi enabled)	Yes
NSF®-certified** sanitize option	Yes
Water softener	No
Five-level wash	Yes
Child Lock button suspension	No
Anti-Fingerprint Finish	Yes
Special features	InfoLight®, ExtraDry option, Zone Wash
Efficiency	
Water usage per cycle	3.2 gal
ENERGY STAR® Certified	Yes
Total annual energy consumption	240 kWh

Capacity

Number of place settings 16

Technical Details

Watts	1440 W
Current	12 Amps
Volts	120 V
Frequency	60 Hz
Power cord full length	67"
Power cord install length from edge of unit when facing the door	Left – 45" Right – 56"
Minimum water pressure	14 lb/sin
Length outlet hose	78 3/4"

Dimensions & Weight

Overall appliance dimensions (HxWxD)	33 7/8" x 23 9/16" x 23 3/4"
Required cutout size (HxWxD)	33 7/8" x 24" x 24"
Adjustable feet	Yes
Net weight	85 lbs

Accessories—Optional

Junction Box	SMZPCJB1UC
Junction Box + Supply Hose Kit	SMZ3IN1UC
Bosch Dishwasher Water Supply Hose	SMZSH1ABUC
Edge Protector + Power Cord Clip Install Kit	SMZEPCC1UC



*Compared to a Bosch dishwasher with 2 racks.

**Certification to NSF/ANSI Standard 184 for residential dishwashers.

Accessories: To purchase Bosch accessories, cleaners & parts please call 1-800-944-2904 (Mon to Fri 5 am to 6 pm PST, Sat 6 am to 3 pm PST).

Notes: All height, width and depth dimensions are shown in inches. BSH reserves the absolute and unrestricted right to change product materials and specifications, at any time, without notice. Consult the product's installation instructions for final dimensional data and other details prior to making cutout.

Warranties: Please see Use & Care manual or Bosch website for statement of limited warranty.

For more information on our entire line of products, go to www.bosch-home.ca or call 1-800-944-2904

© BSH Home Appliances Corporation. All rights reserved. Bosch is a registered trademark of Robert Bosch GmbH.

24" Pocket Handle Dishwasher



500 Series – Stainless Steel SHP55DM5N

Installation Details

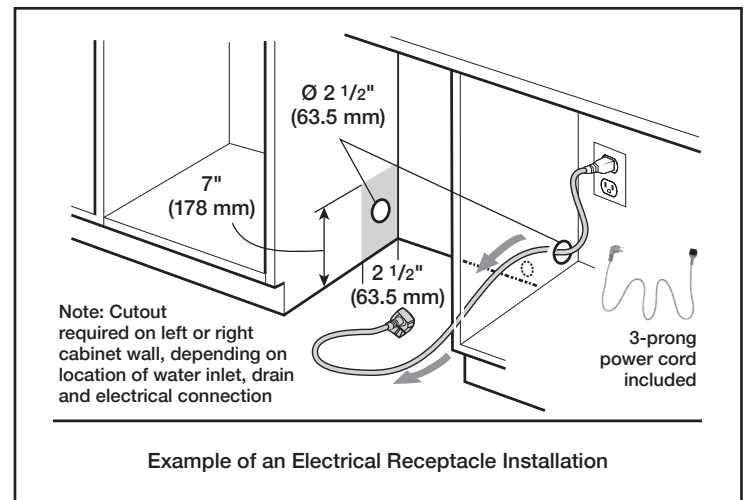
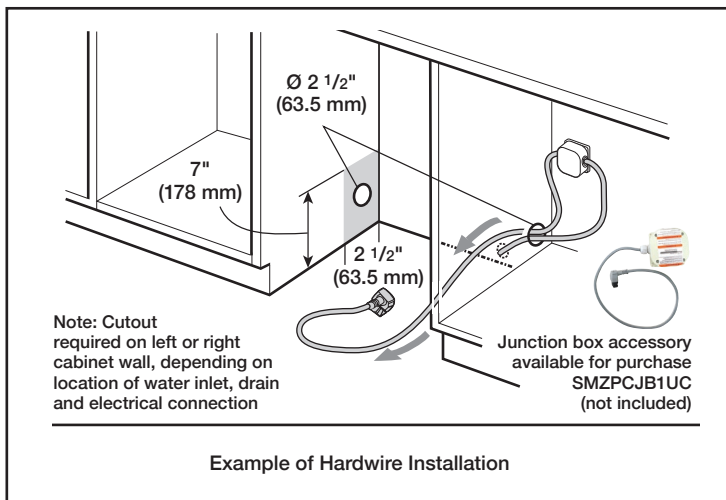
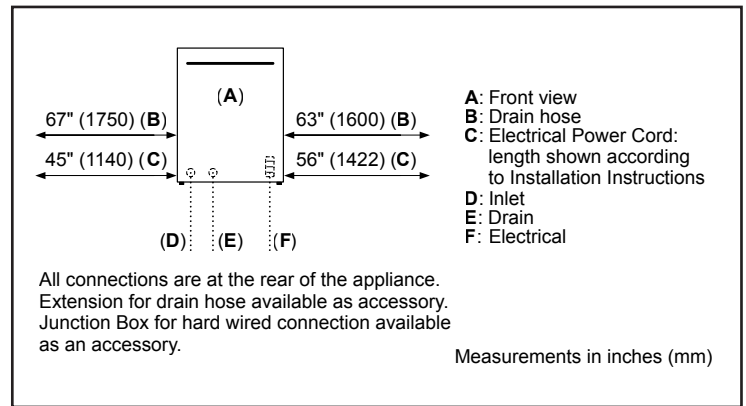
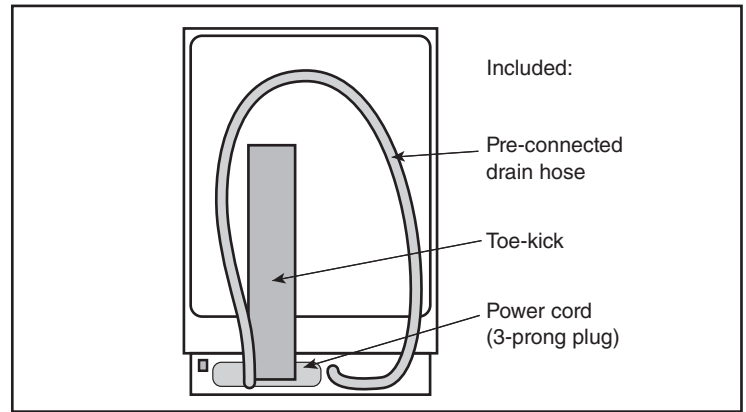
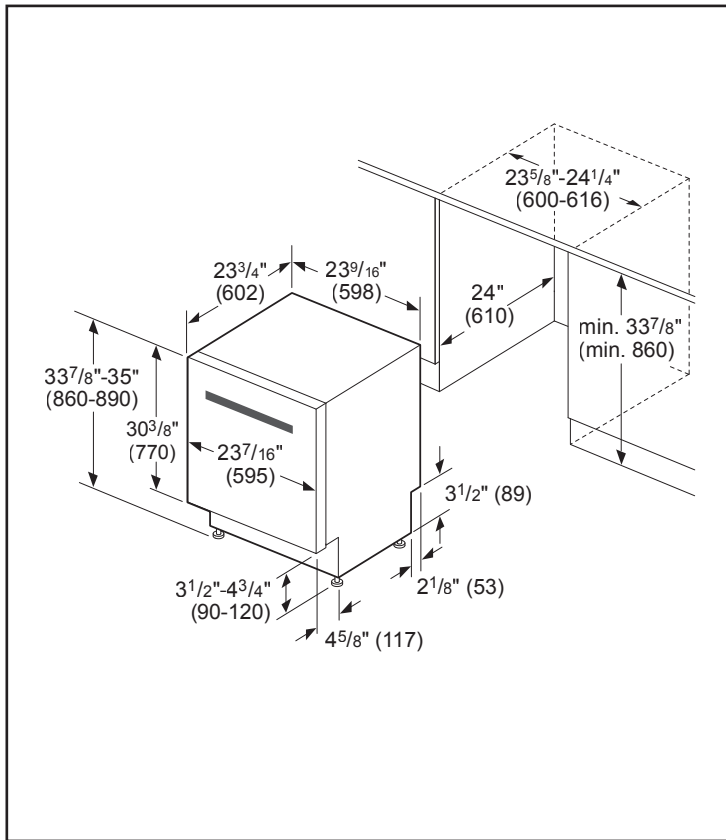

Accessories: To purchase Bosch accessories, cleaners & parts please call 1-800-944-2904 (Mon to Fri 5 am to 6 pm PST, Sat 6 am to 3 pm PST).

Notes: All height, width and depth dimensions are shown in inches. BSH reserves the absolute and unrestricted right to change product materials and specifications, at any time, without notice. Consult the product's installation instructions for final dimensional data and other details prior to making cutout.

Warranties: Please see Use & Care manual or Bosch website for statement of limited warranty.

For more information on our entire line of products, go to www.bosch-home.ca or call 1-800-944-2904

© BSH Home Appliances Corporation. All rights reserved. Bosch is a registered trademark of Robert Bosch GmbH.

24" Pocket Handle Dishwasher



500 Series – Stainless Steel SHP55DM5N

Installation Details

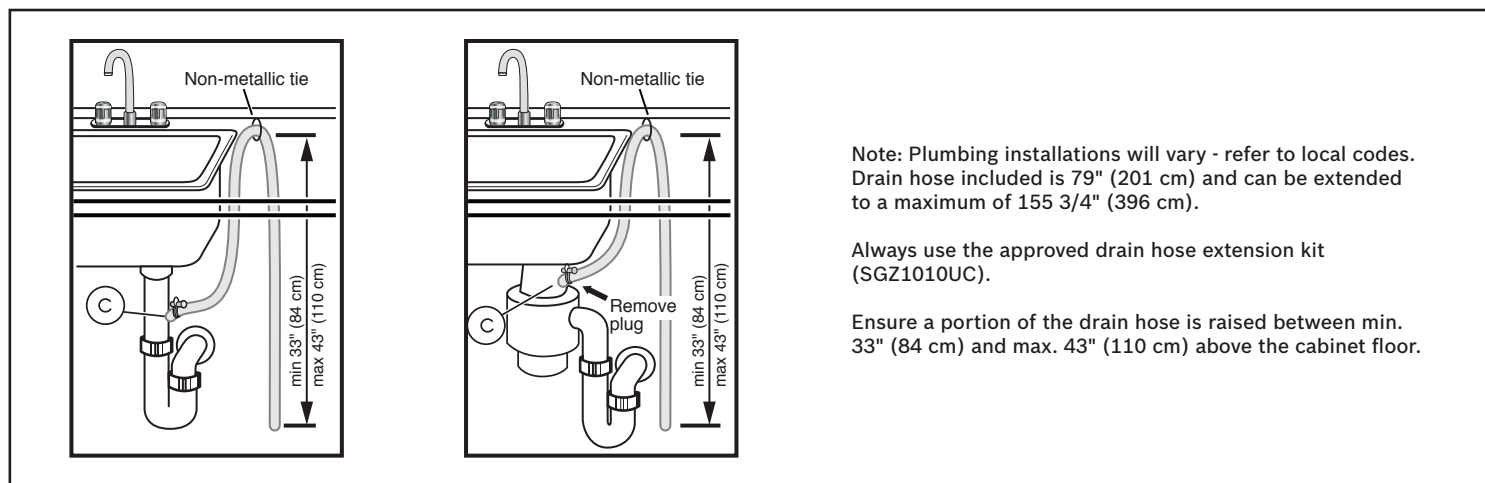

Accessories: To purchase Bosch accessories, cleaners & parts please call 1-800-944-2904 (Mon to Fri 5 am to 6 pm PST, Sat 6 am to 3 pm PST).

Notes: All height, width and depth dimensions are shown in inches. BSH reserves the absolute and unrestricted right to change product materials and specifications, at any time, without notice. Consult the product's installation instructions for final dimensional data and other details prior to making cutout.

Warranties: Please see Use & Care manual or Bosch website for statement of limited warranty.

For more information on our entire line of products, go to www.bosch-home.ca or call 1-800-944-2904

© BSH Home Appliances Corporation. All rights reserved. Bosch is a registered trademark of Robert Bosch GmbH.