

Filtro supresor de interferencias

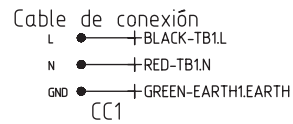

Portador puesta a tierra

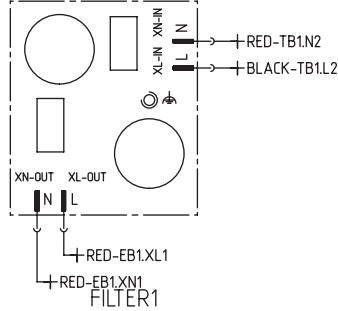

Bloque de terminales

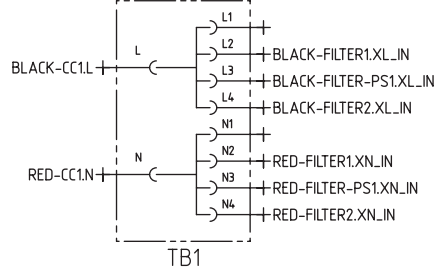

Filtro supresor de interferencias

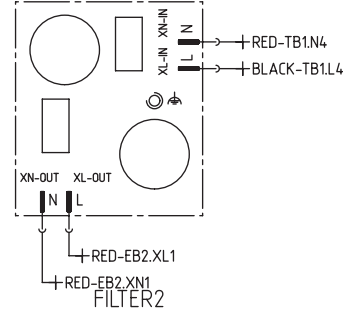

Unidad de alimentación

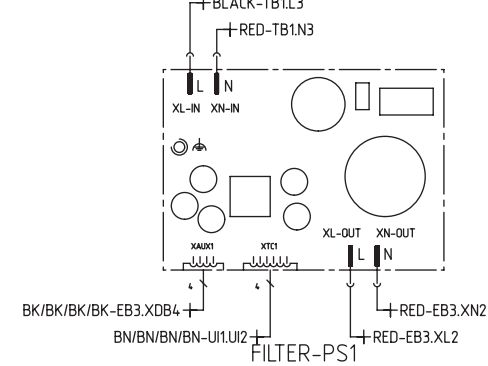

Ventilador

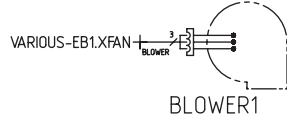

Sensor de temperatura

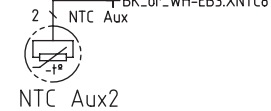

Bobina de inducción

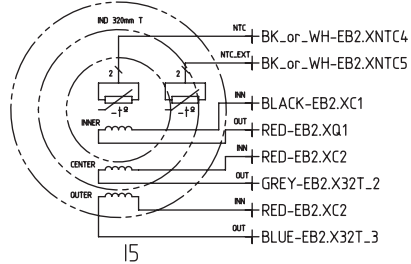

Unidad electrónica de potencia

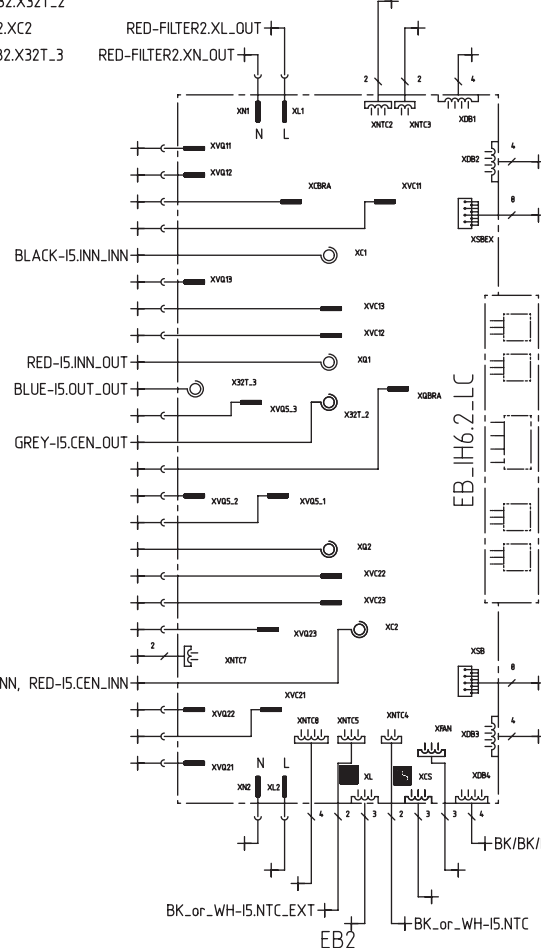

Unidad electrónica de potencia

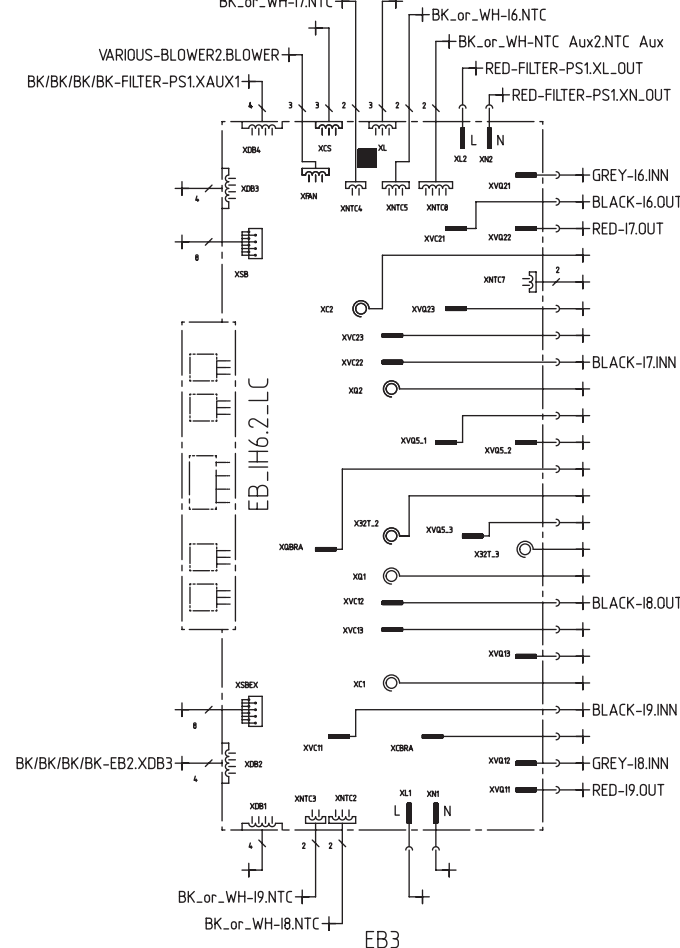

Bobina de inducción

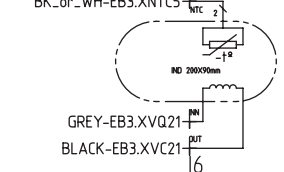

Bobina de inducción

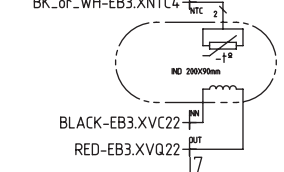

Bobina de inducción

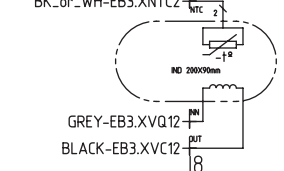

Bobina de inducción

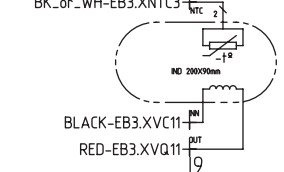

Bobina de inducción

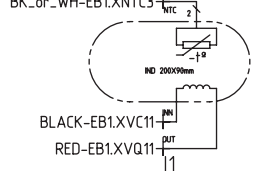

Bobina de inducción

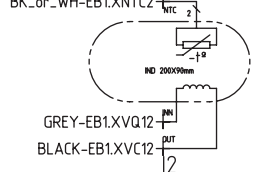

Bobina de inducción

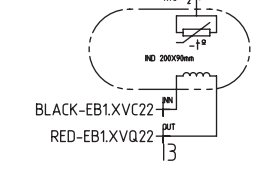

Bobina de inducción

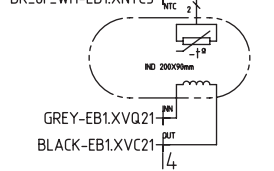

Unidad electrónica de potencia

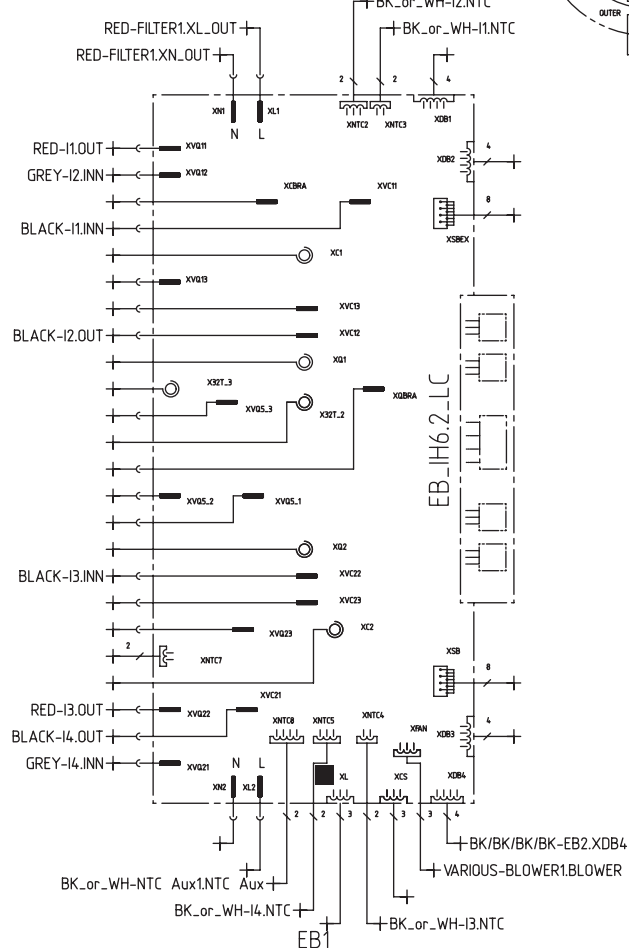

Sensor de temperatura

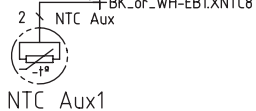

Placa electrónica de mando

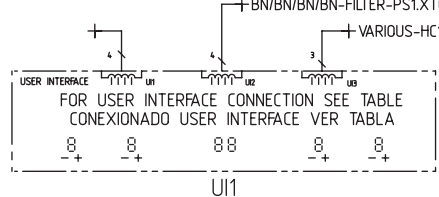

Módulo de comunicación

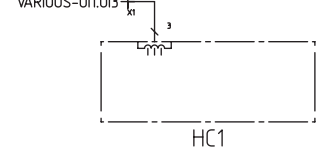

COLOURS IEC 60757			
Blue / Azul	BU	Orange / Naranja	OG
Brown / Marrón	BN	Pink / Rosa	PK
Black / Negro	BK	Turquoise / Turquesa	TQ
White / Blanco	WH	Grey / Gris	GY
Red / Rojo	RD	Violet / Violeta	VT
Green / Verde	GN	Gold / Oro	GD
Yellow / Amarillo	YE	Silver / Plata	SR
Green-Yellow / Verde-Amarillo	GN YE		

USER INTERFACE CONNECTION PORTS / PUERTOS DE CONEXIÓN DEL USER INTERFACE			
PORT NAME / NOMBRE PUERTO	UI1	UI2	UI3
YL238	-	X32	X10