

BOSCH

Use & Care Manual



For
Single and Double Built-in Ovens
Models
HBL 73../74../75../76.. and HBN 74../75../76..

A Special Message to Our Customers

Dear Bosch Oven Owner:

Thank you and congratulations on the purchase of your Bosch oven. Whether you are an expert chef or an aspiring cook, we know that your new oven will exceed your expectations. Decades of knowledge and experience are built into this oven making it among the highest quality, most versatile and most efficient available.

We ask that you read this manual thoroughly before using your new oven. Please pay particular attention to the Safety Precautions printed at the front of this book and the numerous safety hints and cautions placed throughout. Also, be sure to familiarize yourself with the proper operation of the oven and its cleaning and maintenance procedures. Adherence to these instructions and procedures will assure that you realize the full potential of your new Bosch oven as well as maintain it for years of dependable use.

Thank you and good cooking,

BSH Home Appliances

Table of Contents

Safety Precautions	2-3	Special Features	27-30
Les Instructions De Sécurité	4-5	Lock Keys (Child Lockout)	27
Important (Safety Instructions in French)		Sabbath Mode	
Cooking with the		(for religious faiths with “no work”	
BOSCH Convection Oven	6	requirements on the Sabbath)	28
Features of Your Oven	7-10	Oven Offset	
The Control Panel	8	(calibrate the oven temperature)	28
Oven Modes	9	Language (select English,	
General Oven Information	10	Spanish, or French)	29
Oven Operation	11-26	Temperature Units	
General Oven Tips	11	(Fahrenheit or Centigrade)	29
Setting the Clock	12	Clock Format (12 hr or 24 hr)	29
Using Oven Timer	13	Beep Volume	30
Using Oven Lights	13	View Clock	30
Selecting the Oven Mode	14	Default Data	30
Time Oven Mode Operation	15	Oven Care and Cleaning	31-34
Bake Tips and Techniques	16	Self-Cleaning the Oven	31
Bake Cook Chart	17	Preparing the Oven for Self-Clean	31
Convection Bake Tips and Techniques ..	18	Setting the Self-Clean Mode	32
Convection Bake Chart	19	General Oven Care	33
Convection Roast Tips and Techniques .	20	Oven Finishes/Cleaning Methods	34
Convection Roasting with the Probe	20-22	Do-It-Yourself Maintenance	35-40
Convection Roast Chart	23	Oven Door Removal	35-36
Broil Tips and Techniques	24	Replacing an Oven Light	37
Broil Chart	24	Solving Problems	38 - 39
Convection Broil	25	Solving Baking Problems	38
Convection Broil Chart	25	Solving Operational Problems	39
Dehydrate Tips and Techniques	26	How to Obtain Service	39
Warming Tips and Techniques	26	Model Warranty	40
Proofing and Defrosting		Service Data Record	40
Tips and Techniques	26		

General Appliance and Oven SAFETY PRECAUTIONS

Please read all instructions before using this appliance.



WARNING

When properly cared for, your new Bosch oven has been designed to be a safe, reliable appliance. **Read all instructions carefully before using this oven. These precautions will reduce the risk of burns, electric shock, fire, and injury to persons. When using kitchen appliances, basic safety precautions must be followed, including the following:**

- This appliance must be properly installed and grounded by a qualified technician. Connect only to properly grounded outlet. See “Grounding Instructions” found in the Installation Instructions.
 - This appliance should be serviced only by a qualified service technician. Contact the nearest **authorized service center** for examination, repair or adjustment.
 - **Do not** repair or replace any part of the oven unless specifically recommended. Refer service to an authorized servicer.
 - **Do not** operate this appliance if it is not working properly or if it has been damaged, until an authorized servicer has examined it.
 - Install or locate this appliance only in accordance with the Installation Instructions.
 - Use this oven only as intended by the manufacturer. If you have any questions, contact the manufacturer.
 - **Do not cover** or block any openings on this appliance.
 - Use this appliance only for its intended use as described in this manual. Do not use corrosive chemicals, vapors, or nonfood products in this appliance. This type of oven is specifically designed to heat or cook. It is not designed for industrial or laboratory use. The use of corrosive chemicals in heating or cleaning will damage the appliance.
 - In the event that personal clothing or hair catches fire, **DROP AND ROLL IMMEDIATELY** to extinguish flames.
- **Do not** allow children to use this appliance unless closely supervised by an adult. Children and pets should not be left alone or unattended in the area where the appliance is in use. Never allow children to sit or stand on any part of the oven.
 - **Do not** store items of interest to children above the oven. If children should climb onto the appliance to reach these items, they could be seriously injured.

To reduce the risk of fire in the oven cavity:

1. **Do not** store flammable materials in or near the oven.
2. **Do not** use water on a grease fire. Smother fire or use a dry chemical or foam-type extinguisher.
3. It is highly recommended that a fire extinguisher be readily available and highly visible next to any cooking appliance.
4. **Do not** overcook food. Carefully attend oven if paper, plastic or other combustible materials are placed inside the oven.
5. **Do not** use the cavity for storage purposes. Do not leave paper products, cooking utensils or food in the cavity when not being used.
6. If materials inside the oven should ignite, keep oven door closed. Turn oven off and disconnect the circuit at the circuit breaker box.
7. **Do not** block any vent openings.
8. Be sure the blower fan runs whenever the oven is in operation. If the fan does not operate, **do not** use the oven. Call an authorized service center.
9. Never use the oven to warm or heat a room. This can damage the oven parts.
10. For personal safety, wear proper clothing. Loose fitting or garments with hanging sleeves should never be worn while using this appliance.

Continued on next page

IMPORTANT SAFETY INSTRUCTIONS

Please read all instructions before using this appliance.

SAFETY FOR THE OVEN

- Tie long hair so that it doesn't hang loose.
- Do not touch heating elements or interior surfaces of oven.
- The heating elements may be hot even though they are dark in color. Interior surfaces of an oven become hot enough to cause burns.
- During and after use, do not touch or let clothing or other flammable materials contact the heating elements or the interior surfaces of the oven until they have had sufficient time to cool.
- The trim on the top and sides of the oven door may become hot enough to cause burns.
- Use care when opening the door. Open the door slightly to let hot air or steam escape before removing or replacing food.
- Do not heat unopened food containers. Build-up of pressure may cause the container to burst and cause injury.
- Always place oven racks in desired location while oven is cool. If a rack must be moved while oven is hot, do not let pot holder contact the hot heating elements.
- Use only dry pot holders. Moist or damp pot holders on hot surfaces may result in burns from steam. Do not let pot holder touch hot heating elements. Do not use a towel or other bulky cloth.

SAFETY FOR THE SELF-CLEANING OVEN

- Confirm that the door locks and will not open once START is touched and the door lock icon appears. If the door does not lock, touch UPPER CANCEL or LOWER CANCEL and do not run Self-Clean. Phone 800/735-4328 for service (see Page 39 for obtaining service).
- Do not clean the door gasket. It is essential for a good seal. Care should be taken not to rub, damage, move or remove the door gasket.
- Do not use commercial oven cleaners or oven liner protective coatings of any kind in or around any part of the oven.
- Clean only oven parts listed in this manual.
- Before self-cleaning the oven, remove the broiler pan, oven racks, other utensils and excess soft spillage.



WARNING

The California Safe Drinking Water and Toxic Enforcement Act requires businesses to warn customers of potential exposure to substances which are known by the State of California to cause cancer or reproductive harm.

The elimination of soil during self-cleaning generates some by-products which are on this list of substances.

To minimize exposure to these substances, always operate this oven according to the instructions in this manual and provide good ventilation to the room during and immediately after self-cleaning the oven.

INSTRUCTIONS DE SÉCURITÉ

pour four et appareil en général

Lire toutes les instructions avant d'utiliser cet appareil.



AVERTISSEMENT

Lorsque l'entretien est effectué de façon appropriée, ce nouveau four Bosch a été conçu pour offrir sécurité et fiabilité. **Lire attentivement toutes les instructions avant d'utiliser ce four. Ces précautions permettront de réduire tout risque de brûlures, de chocs électriques, d'incendie et de blessures. Au moment d'utiliser des électroménagers, des précautions de base doivent être observées, incluant ce qui suit.**

- Cet appareil doit être installé et mis à la terre de façon appropriée par un technicien qualifié. Brancher seulement sur une prise mise à la terre. Voir « Instructions de mise à la terre » dans les instructions d'installation.
- Seul un technicien qualifié peut effectuer le service de cet appareil. Communiquer avec un centre de service autorisé pour toute vérification, réparation ou réglage.
- Ne pas réparer ni remplacer toute pièce du four à moins que cela ne soit recommandé spécifiquement. Consulter un centre de service autorisé.
- Ne pas utiliser cet appareil s'il ne fonctionne pas adéquatement ou s'il a été endommagé sans qu'un technicien qualifié ne l'ait d'abord vérifié.
- Installer cet appareil seulement selon les instructions d'installation.
- Utiliser ce four pour l'usage auquel il est destiné par le fabricant. Pour toute question, communiquer avec le fabricant.
- Ne pas couvrir ni obstruer les ouvertures de cet appareil.
- Utiliser cet appareil seulement pour l'usage auquel il est destiné selon les instructions de ce guide. Ne pas utiliser de produits corrosifs, chimiques, ou des produits non alimentaires dans cet appareil. Ce type de four est conçu spécifiquement pour chauffer et cuire. Il n'est pas destiné à un usage industriel ou en laboratoire. L'utilisation de produits chimiques corrosifs pour le chauffage ou le nettoyage peut endommager l'appareil.
- Dans le cas où des vêtements ou des cheveux prennent feu, SE LAISSER TOMBER AU SOL ET SE ROULER IMMÉDIATEMENT pour éteindre les flammes.
- Ne pas laisser des enfant utiliser cet appareil, à moins d'une surveillance étroite d'un adulte. Les enfants ou des animaux ne doivent pas être laissés seuls ou sans surveillance lorsque cet appareil est utilisé. Ne jamais laisser les enfants s'asseoir ou monter sur l'appareil.
- Ne jamais ranger d'articles, pouvant intéresser les enfants, au-dessus du four. Si les enfants doivent monter sur le four pour atteindre ces objets, ils peuvent se blesser sérieusement.

Pour réduire les risques d'incendie dans la cavité du four :

1. **Ne pas** ranger de matériaux inflammables près ou dans le four.
2. **Ne pas** utiliser d'eau sur un feu de graisse. Éteindre le feu ou utiliser un extincteur de type à mousse ou chimique sec.
3. Il est recommandé qu'un extincteur soit disponible et placé visiblement près de l'appareil de cuisson.
4. **Ne pas** surcuire les aliments. Faire attention si du papier, du plastique ou autres matériaux combustibles sont placés dans le four.
5. **Ne pas** utiliser la cavité à des fins de rangement. Ne pas laisser de produits en papier, des ustensiles ou des aliments dans la cavité si l'appareil n'est pas utilisé.
6. Si des matériaux dans le four s'enflamment, laisser la porte du four fermée. Mettre le four hors circuit, débrancher le circuit à la boîte de jonction.
7. **Ne pas** obstruer les événements.
8. S'assurer que le ventilateur fonctionne lorsque le four est en marche. Si le ventilateur ne fonctionne pas, ne pas utiliser le four. Communiquer avec un centre de service autorisé.
9. Ne jamais utiliser ce four pour chauffer ou réchauffer une pièce. Ceci peut endommager les pièces du four.
10. Pour plus de sécurité, porter des vêtements adéquats. Des vêtements lâches ou pendants ne doivent jamais être portés si l'on utilise le four.

Suite à la page suivante

INSTRUCTIONS DE SÉCURITÉ IMPORTANTES

Lire toutes les instructions avant d'utiliser cet appareil.

SÉCURITÉ POUR LE FOUR

- Les cheveux longs doivent être attachés.
- Ne pas toucher aux éléments chauffants ni aux surfaces intérieures du four.
- Les éléments chauffants peuvent être chauds même s'ils sont de couleur foncée. Les surfaces intérieures du four sont suffisamment chaudes pour causer des brûlures.
- Pendant et après l'utilisation, ne pas toucher, ni laisser des vêtements ou autres matériaux inflammables entrer en contact avec les éléments chauffants ou les surfaces intérieures du four. Laisser suffisamment de temps au four pour refroidir.
- Les garnitures sur le dessus et les côtés de la porte du four peuvent devenir assez chaudes pour causer des brûlures.
- Faire attention en ouvrant la porte du four. Ouvrir la porte légèrement pour laisser l'air chaud ou la vapeur s'échapper avant d'enlever ou de mettre des aliments dans le four.
- Ne pas faire chauffer des contenants d'aliments hermétiques. L'accumulation de pression peut faire exploser le contenant et causer des blessures.
- Toujours placer les tablettes à l'endroit désiré lorsque le four est froid. Si une tablette doit être enlevée lorsque le four est chaud, ne pas laisser les tire-plats entrer en contact avec les éléments chauffants.
- Utiliser seulement des tire-plats secs. Des tire-plats humides ou mouillés sur des surfaces chaudes peuvent causer des brûlures de vapeur. Ne pas toucher aux éléments chauffants. Ne pas utiliser de serviettes ou autres chiffons.

SÉCURITÉ POUR LE FOUR AUTO-NETTOYANT

- S'assurer que la porte est verrouillée et ne peut s'ouvrir une fois la touche START pressée et que l'icône de porte verrouillée s'affiche. Si la porte ne se verrouille pas, presser la touche UPPER CANCEL ou LOWER CANCEL (annulation supérieure ou annulation inférieure) et ne pas actionner la fonction auto-nettoyante. Téléphoner au 800-735-4328 pour tout service (voir page 39 concernant le service).
- Ne pas nettoyer les joints de la porte. Cela est essentiel pour une bonne étanchéité. Il faut faire attention pour ne pas récuser, endommager, déplacer ou enlever le joint de la porte.
- Nettoyer seulement les pièces indiquées dans ce guide.
- Avant d'effectuer le nettoyage du four, enlever le plateau, les tablettes, les ustensiles et tout déversement.



AVERTISSEMENT

Le règlement « California Safe Drinking Water and Toxic Enforcement Act » exige que les compagnies avisent les clients du danger potentiel d'exposition aux substances reconnues par l'état de la Californie comme pouvant causer le cancer ou des problèmes de santé reliés à la reproduction.

L'élimination des résidus pendant le fonctionnement auto-nettoyant peut générer certains sous produits dérivés donnés dans la liste.

Afin de minimiser l'exposition à ces substances, toujours faire fonctionner ce four conformément aux instructions de ce guide et assurer une bonne ventilation à la pièce pendant et immédiatement après le nettoyage du four.

Cooking with the BOSCH Convection Oven

In a conventional oven, the heat source cycles on and off to maintain an average temperature in the oven cavity. As the temperature gradually rises and falls, gentle air currents are produced within the oven. This natural convection tends to be inefficient because the currents are irregular and slow. In the Bosch convection system, the heat is “conveyed” by a fan that provides continuous circulation of the hot air.

The Bosch Genuine European Convection™ system provides state-of-the-art engineering and advanced design to create the finest convection oven. In standard convection ovens, a fan simply circulates the hot air around the food. The Bosch convection system is characterized by the combination of an additional heating element located around the convection fan and the venting panel that distributes heated air in three dimensions: along the sides, the top and the full depth of the oven cavity. This Genuine European Convection system aids in maintaining a more even oven temperature throughout the oven cavity.

The circulating air aids in speeding up the baking process and cooks the food more evenly. By controlling the movement of heated air, convection cooking produces evenly browned foods that are crispy on the outside yet moist inside. Convection cooking works best for breads and pastries as well as meats and poultry. Air-leavened foods like angel food cakes, soufflés and cream puffs rise higher than in a conventional oven. Meats stay juicy and tender while the outside is flavorful and crisp.

By using Bosch Genuine European Convection, foods can be cooked at a lower temperature and cooking times can be shorter. When using the Convection Bake mode, the standard oven temperature should be lowered by 25°F. Foods requiring a cooking time of less than 30 minutes should be checked slightly earlier than normal. Items that typically cook for 45 minutes or more should take 15-25% less time. For best results, foods should be cooked uncovered, in low-sided pans to take advantage of the forced air circulation. When using the Convection Roast mode, the standard oven temperature does not need to be reduced.

Advantages of Convection Cooking

- Even baking, browning and crisping are achieved.
- During roasting, juices and flavors are sealed in while the exterior is crisp.
- Yeast breads are lighter, more evenly textured, more golden and crustier.
- Air-leavened foods such as cream puffs, soufflés and meringues are higher and lighter.
- Baking on multiple racks at the same time is possible with even results.
- Multiple-rack baking saves time.
- Prepare whole meals at once with no flavor transfer.
- Dehydrates herbs, fruits and vegetables.
- Requires no specialized bakeware.
- Saves time and energy.
- Convection broiling allows for extraordinary grilling with thicker cuts of food.

Features of Your Oven

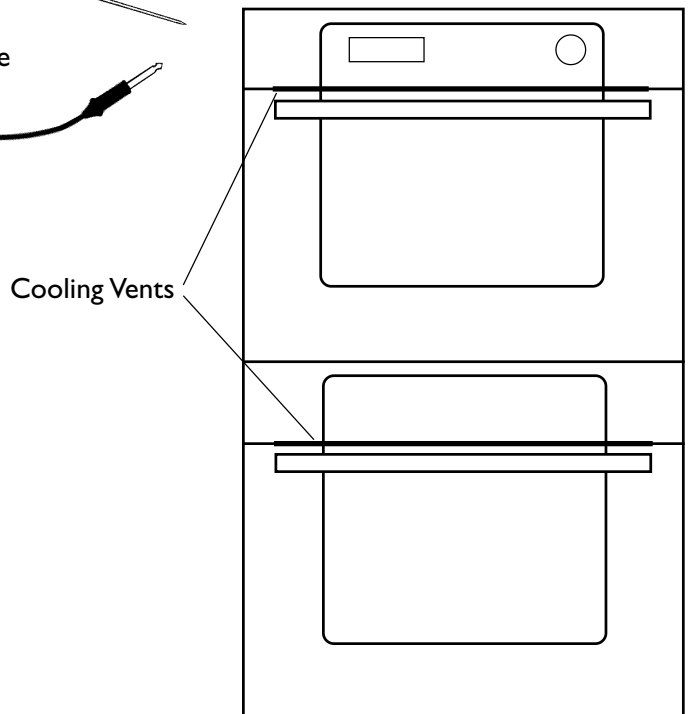
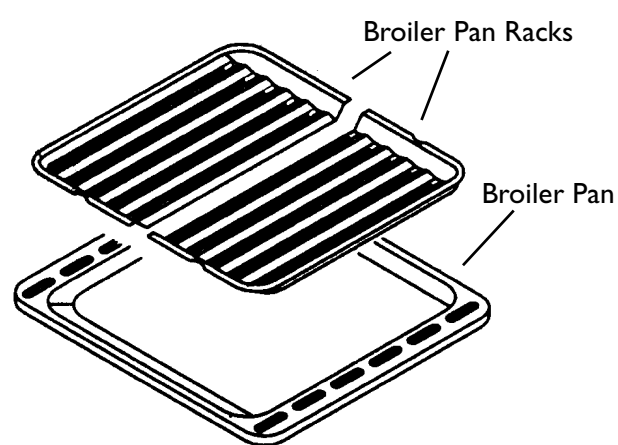
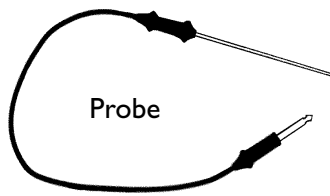
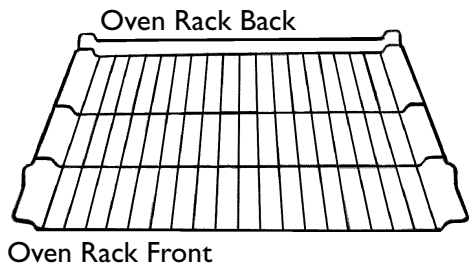
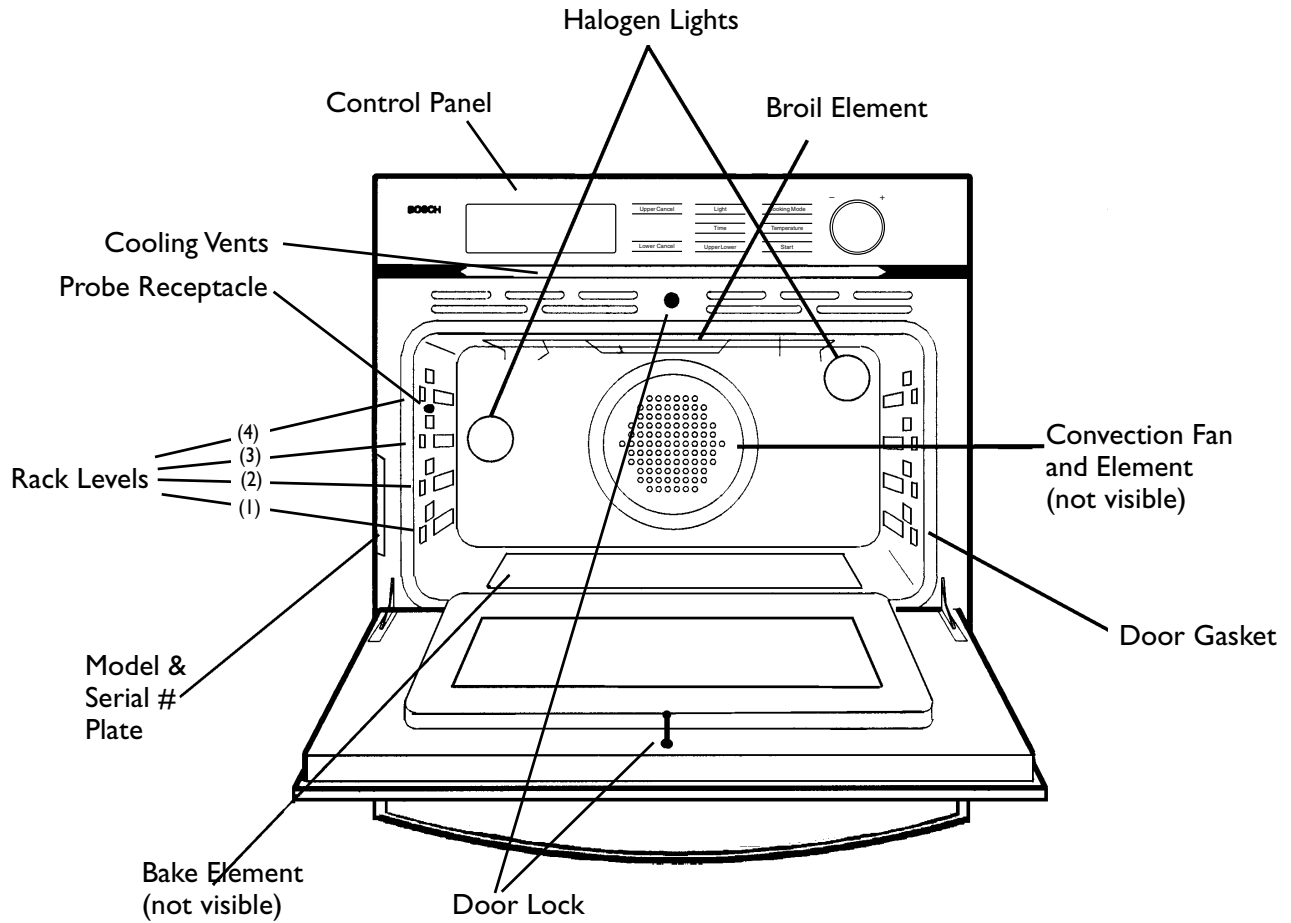

The Control Panel

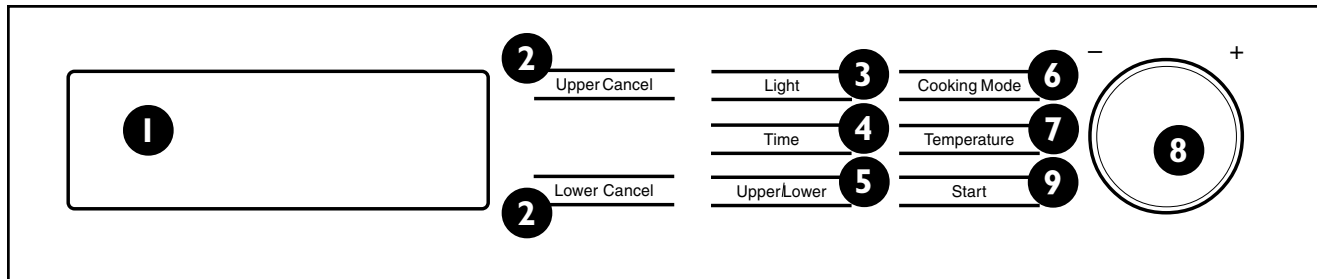

Double Oven Control Panel

The control panel allows you to program either the upper or lower oven. As you touch the pads and turn the control knob, words and numbers appear in the display window. Touch only one pad at a time.

I. Display Window – this window shows the following information:

- **Clock** – shows the time of day with a 12-hour or 24-hour clock option (See Page 12).
 - **Timer Settings** – counts down the time in minutes.
 - **Oven Selection** – Upper and/or Lower.
 - **Cooking or Timed Mode** – shows the number of hours and minutes the oven will be “on.”
 - **Elements** – displays which element(s) are active during a cooking mode.
 - **Oven Temperature** – Shows temperature setting in fahrenheit or centigrade. (See Page 29).
 - **PREHEAT** – indicates that the oven is preheating.
2. **UPPER CANCEL and LOWER CANCEL** – touch to turn off active oven.
 3. **Light** – touch to turn oven light on or off.
 4. **Time** – touch to set the timer, change the timer or clear the timer.
 5. **Upper/Lower** – touch to select the upper or lower oven. Oven selected is highlighted in the display window.
 6. **Cooking Mode** – touch to display oven temperature, oven selected and cooking mode.
 7. **Temperature** – touch to set cooking temperatures.
 8. **Control Knob** – used to set the clock, timers, select cooking mode and temperature. Allows for increasing or decreasing numerals relating to clock time or timer setting and oven temperature. Push on knob to pop out the knob when making selections. Conversely, push the knob in to retract it back into the control panel after selections are made.
 9. **Start** – touch to complete an entry.

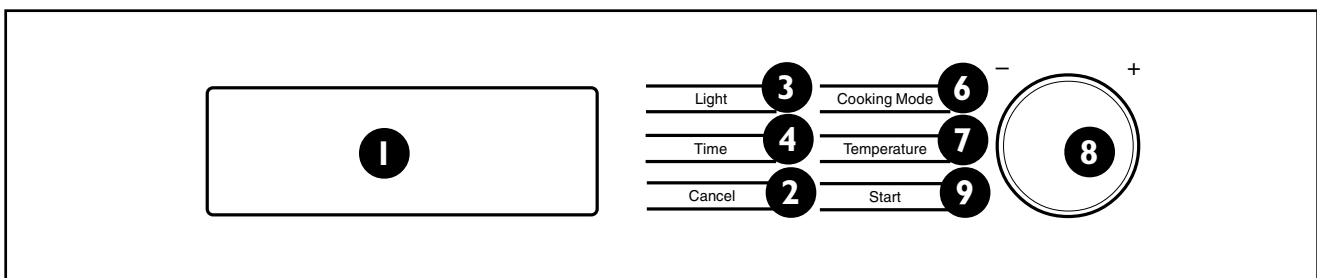

Single Oven Control Panel

Oven Modes

The following illustrations give an overview of what happens in the oven with each mode setting. The arrows represent the location of the heat source during specific modes. The lower element is concealed under the oven floor.

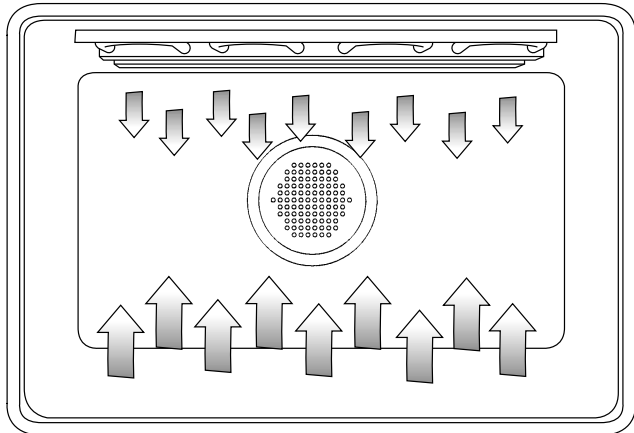

BAKE and WARMING

Baking is cooking with heated air. Both the upper and lower element cycle to maintain the oven temperature. In the Warming mode, the oven will use the lower element to maintain a low temperature to keep food at serving temperature.

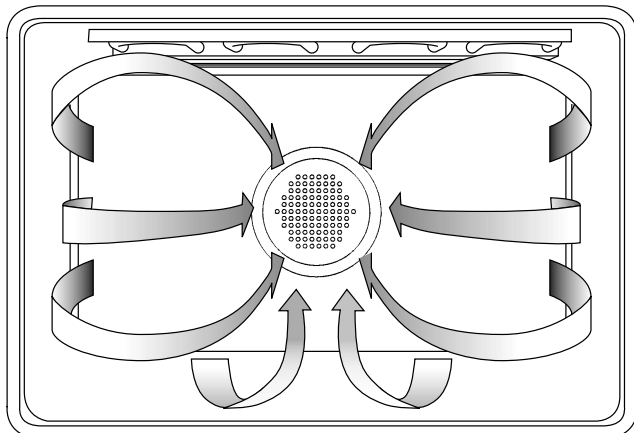

CONVECTION BAKE and DEHYDRATE

Convection Bake cooks with heat from a third element behind the back wall of the oven. The heat is circulated throughout the oven by the convection fan. Dehydrating is similar to convection cooking and holds an optimum low temperature while circulating the heated air to remove moisture slowly for food preservation.

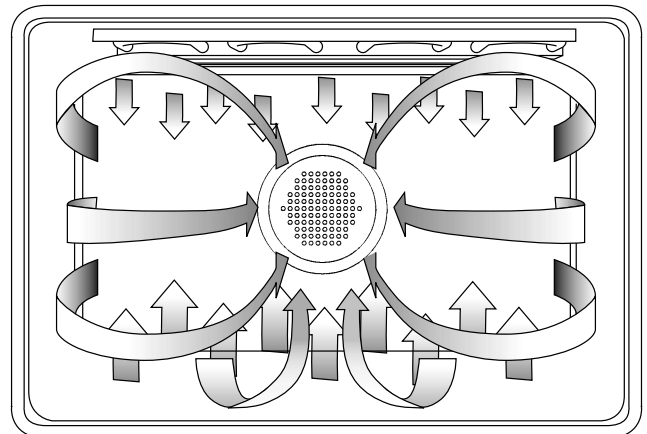

CONVECTION ROAST

Convection Roast uses the top element, bottom element and convection fan.

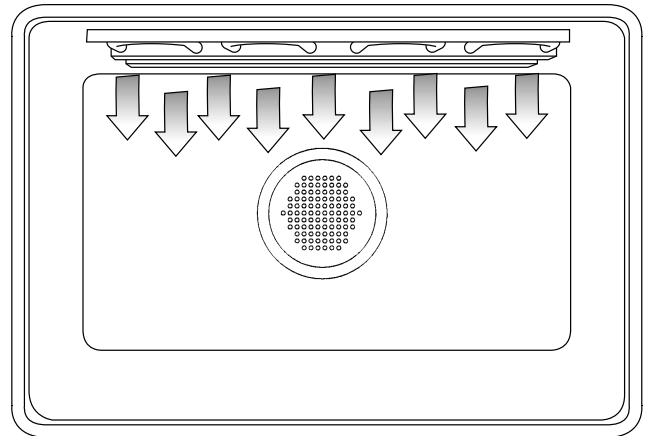

BROIL

Broiling uses intense heat radiated from the upper element.

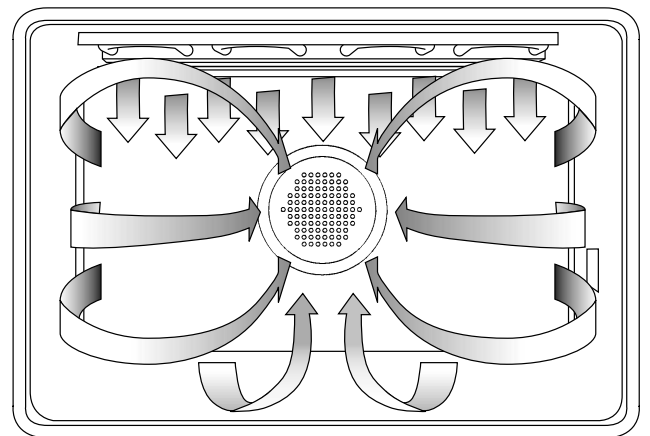

CONVECTION BROIL

Convection Broil combines the intense heat from the upper element with the heat circulated by the convection fan.

General Oven Information

Before using your Bosch oven for the first time remove all packing and foreign materials from the oven(s). Any material of this sort left in the oven(s) may melt and/or burn when the oven(s) is(are) used.

Flashing Symbols or Numbers

Signals an incomplete setting and calls for another step or START to be touched.

Beeps

Signals that more information must be entered or confirms the receipt of an entry. Beeps also signal the end of a function or an oven fault.

Probe Symbol

The probe symbol will be displayed when the probe is inserted into the probe receptacle. The internal temperature of the meat is also displayed in place of the oven roasting temperature. The selected probe temperature can be displayed by touching TEMPERATURE. Oven temperature can be displayed by touching TEMPERATURE two times.

Lock Symbol

Displays during the Self-Clean mode and when the door is locked. Do not attempt to open the door when the lock symbol or **UNLOCKING DOOR** is displayed. Door can be opened when the symbol no longer appears.

Power Failure

After the power returns to the oven, the clock displays the time when the power was lost or turned off.

Default Settings

The cooking modes automatically select a suitable temperature. These can be changed when a different one is needed.

F Number Codes

These codes are displayed when there is a problem with the signal sent to the electronic control board. See *Solving Operational Problems*, Page 39.

Convection Fan

The convection fan operates during any convection mode. When the oven is operating in the convection mode, the fan will turn off automatically when the door is opened. The convection fan will run during the preheat time for specific modes.

Component Cooling Fan

Activates during any cooking or self-cleaning mode to cool inner components and outer door surfaces. This air is exhausted through the vent located above the oven door. It continues to run until components have cooled sufficiently.

General Oven Tips

Preheating the Oven

- Preheat the oven when using the Bake, Convection Bake and Convection Roast modes.
- Preheating for Convection Roast when using the probe is not recommended. See Pages 20 through 22 for details and tips.
- Selecting a higher temperature does not shorten the preheat time.
- Preheating is necessary for good results when baking cakes, cookies, pastry and breads.
- Preheating will help to sear roasts and seal in meat juices.
- Place oven racks in their proper position before preheating.
- During preheat, the selected cooking temperature can be displayed by touching TEMPERATURE.
- A beep will confirm that the oven is preheated and the selected cooking temperature will be displayed.
- Fast Preheat Bake and Fast Preheat Convection Bake can be used when time is crucial.

Operational Suggestions

- Use the cooking charts as a guide.
- Do not set pans on the opened oven door.
- Use the interior oven light to view the food through the oven door window rather than opening the door frequently.

Utensils

- Glass baking dishes absorb heat. Reduce oven temperature 25°F when baking in glass.
- Use pans that give the desired browning. The type of finish on the pan will help determine the amount of browning that will occur.
- Shiny, smooth metal or light nonstick/anodized pans reflect heat, resulting in lighter, more delicate browning. Cakes and cookies require this type of utensil.
- Dark, rough or dull pans will absorb heat resulting in a browner, crisper crust. Use this type for pies.
- For brown, crisp crusts, use dark nonstick/anodized or dark, dull metal utensils or glass bakeware. Insulated baking pans may increase the length of cooking time.
- Do not cook with the empty broiler pan in the oven, as this could change cooking performance. Store the broil pan outside of the oven.

High Altitude Baking

- When cooking at high altitude, recipes and cooking time will vary from the standard. For accurate information, write the Extension Service, Colorado State University, Fort Collins, Colorado 80521. There may be a charge for the bulletins.

Oven Condensation and Temperature

- It is normal for a certain amount of moisture to evaporate from the food during any cooking process. The amount depends on the moisture content of the food. The moisture may condense on any surface cooler than the inside of the oven, such as the control panel.
- Your new Bosch oven has an electronic temperature sensor that accurately maintains the temperature selected. Your previous oven may have had a mechanical thermostat that drifted gradually over time to a higher temperature. It is normal that you may need to adjust your favorite recipes when cooking in a new oven.

Oven Racks

- The oven has rack guides at four levels as shown in the illustration on Page 7.
- Rack positions are numbered from the bottom rack guide (#1) to the top (#4).
- Check cooking charts for best rack positions to use when cooking.
- Each level guide consists of paired supports formed in the walls on each side of the oven cavity.
- Always be sure to position the oven racks before turning on the oven. Make sure that the racks are level once they are in position.
- To remove oven rack from the oven, pull rack forward, lift rack up at front and then remove it.
- To replace an oven rack:
 1. Place rear of rack between rack level guides.
 2. While lifting front of rack, slide rack in all the way while lowering the front. Please refer to illustration on Page 7 if there is any question as to which side is the front of the rack.
- The racks are designed to stop when pulled forward to their limit.
- CAUTION! Never use aluminum foil to cover the oven racks or to line the oven. It can cause damage to the oven liner if heat is trapped under the foil.

120/240 vs. 120/208 Volt Connection

- Most oven installations will have a 120/240 voltage connection.
- If your oven is installed with 120/208 voltage, the preheat time may be slightly longer than with 120/240 voltage.
- The Self-Clean mode may also require a longer clean time, depending on the amount of soil.

Setting the Clock

- The time of day is displayed in hours and minutes.
- Always set the clock immediately after installation or after a power failure. Once power returns to the oven, the clock displays the time of day when the power was turned off or lost.
- The clock time will appear during all oven operations except when the timer or a timed cooking operation is running.
- The oven is preset to a 12-hour clock and indicates AM and PM.

TO SET THE CLOCK:

1. Touch TIME. The display will begin flashing **TIMER**.

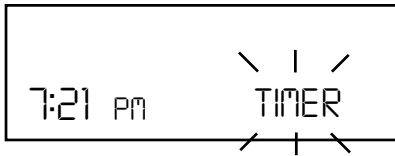

2. Turn rotary knob once to the right or left and **CLOCK** will flash in display.

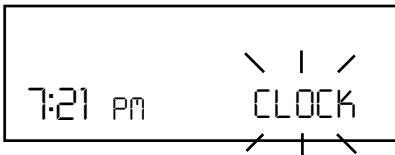

3. Touch TIME again. **ENTER TIME** will appear in the display and clock time will flash.

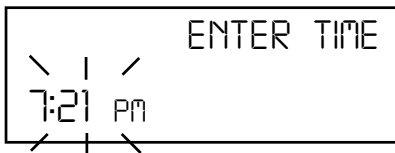

4. Turn the knob to the right or left to quickly move the clock time forward or backward by 10-minute increments. Continue to rotate knob until correct AM or PM is selected.
5. After the initial move of the knob to either the right or left, turn the knob in the *opposite* direction to change the time by 1-minute increments.
6. Touch START. The clock is now set.
 - If operation is not completed, the oven will beep periodically as a reminder to set clock time. Touch START.
 - To cancel the **CLOCK** selection, touch CANCEL at any time when setting the clock.

Using Oven Timer

TO SET THE TIMER:

1. Touch TIME once. Display timer will begin flashing and **TIMER** will appear in display.

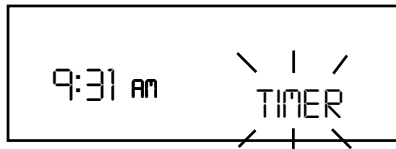

2. Touch TIME again and **TIMER** will appear in display (below clock time). Oven timer will begin flashing.

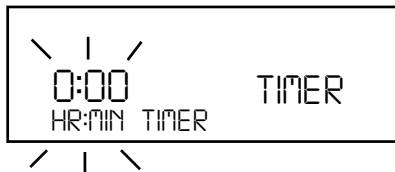

3. Turn knob to the right to increase set time.
4. Turn knob to the left to decrease set time.
5. If the knob is turned too far to the left past zero, then the time will roll over to 59 hr 59 min.

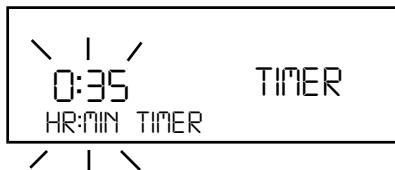

6. Touch START.

If START is not touched, oven will beep as a reminder and **PRESS START** will appear in display and time will flash.



7. **END** will appear in display when time ends. Reminder beeps will sound for up to fifteen minutes or until any pad is touched.

TO CHANGE THE TIMER:

1. Touch TIME 2 times. Display timer will begin flashing and **CHANGE TIMER** will appear in display.

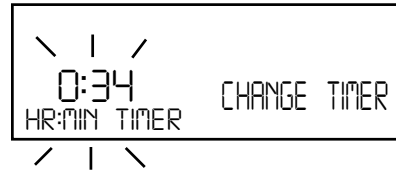

2. Turn knob to change set time.



3. Touch START.
4. If START is not touched, oven will begin beeping, timer display will begin flashing and **PRESS START** will appear in display.

TO CLEAR THE TIMER:

1. Touch TIME once. Display will begin flashing **CHANGE TIMER**.



2. Turn knob once to right and **CLEAR TIMER** will flash in display.



3. Touch TIME.
4. Timer is now cleared and clock time appears in display.
5. If TIME pad is not touched, oven will beep and **CLEAR TIMER** will continue to flash in display.

Using Oven Lights

- A single light pad activates the lights in either oven.
- If LIGHT pad is touched when both ovens are off, lights in both the upper and lower oven will turn on. Touch LIGHT pad again, and both oven lights will turn off.
- Oven lights turn on and off automatically when the door is opened and closed.
- When an oven is in use, oven lights turn on automatically when a mode is selected and START

is touched. Oven lights will turn off automatically when the oven mode is cancelled.

- The lights do not operate in the Self-Clean mode.

To manually control the interior oven lights in either the upper or lower oven if one or both ovens are in use:

1. Touch UPPER/LOWER. The display will indicate which oven is selected.
2. Touch UPPER/LOWER to highlight the other oven. Touch LIGHT to turn lights on or off.

Selecting the Oven Mode

The following oven modes will appear in the display when COOKING MODE is touched and the knob is turned:

BAKE

BROIL

CONVECTION BAKE

CONVECTION BROIL

CONVECTION ROAST

CLEAN

WARMING

FAST PREHEAT BAKE

FAST PREHEAT CONVECT BAKE

DEHYDRATE

SABBATH (optional)

- When the oven is operating, the selected cooking mode will be displayed.
- The oven temperature will appear in the display.

TO SET A COOKING MODE:

1. For double ovens, touch UPPER/LOWER to select the upper oven or lower oven. The selected oven will be highlighted in the display.
2. Touch COOKING MODE.
3. The last mode used will flash in the display. The default temperature for that mode will also be displayed.

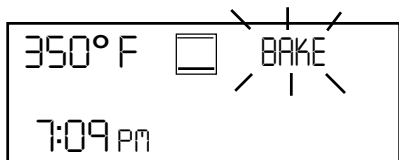

4. If no further setting is made, display will disappear.

Example:

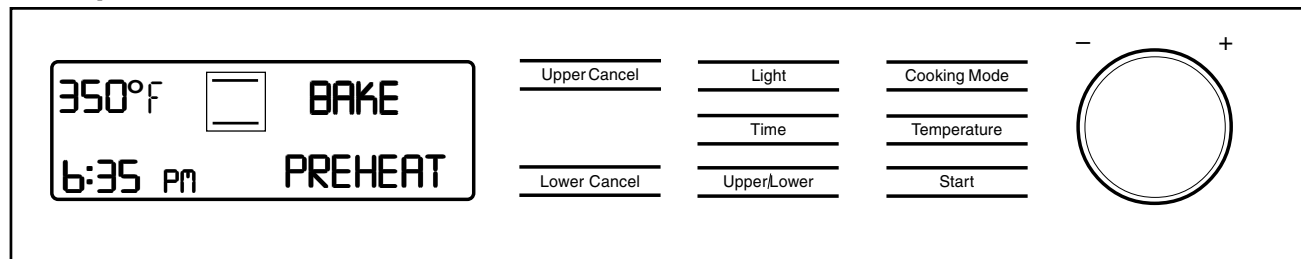

5. To select a different mode, turn the knob to the right or left.
6. The selected mode will appear in the display, along with the default temperature for that mode.
7. To select a different temperature, touch TEMPERATURE and turn knob to the right or left. Temperature can be changed by 5°F.
8. If START is not touched, oven will beep as a reminder and **PRESS START** will appear in display and temperature will flash.

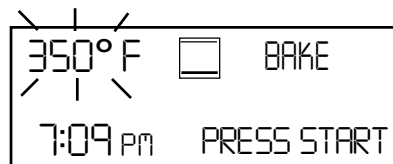

9. Touch START.
10. Oven will begin to heat and oven light will turn on. The temperature display shows the actual temperature, beginning with 100°F. The actual temperature counts up in 5°F increments until set temperature is reached.
11. In modes that require preheat, **PREHEAT** is displayed.
 - When oven has preheated, oven will beep and **PREHEAT** disappears from display.
12. To change temperature during cooking, simply touch TEMPERATURE. Turn the knob to select new temperature and press START.
13. Once cooking has been completed, touch UPPER CANCEL or LOWER CANCEL to turn off oven.

Time Oven Mode Operation

- In double oven models, both ovens can be set independently to operate a timed mode.
- Be sure that the time-of-day clock is displaying the correct time.
- The timed mode turns off the oven at the end of the cook time.

TO SET TIMED MODE:

1. Select oven by touching UPPER/LOWER.
2. Touch COOKING MODE.
 - The last cooking mode used will flash in display. To select a different cooking mode, turn the knob.
 - If necessary, change the default temperature at this time by touching TEMPERATURE.
 - Turn knob to select different temperature.
3. Touch TIME two times. **COOKTIME** will appear in the display and time display will begin flashing.

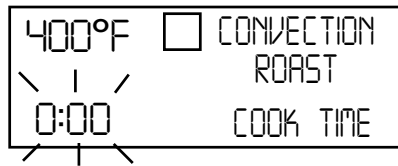

4. Turn knob to enter cooking time. Keep in mind that the time required for the oven to reach temperature must be included in the set cooking time.
5. Touch START.
6. At the end of the programmed cooking time, the oven will automatically turn off.

TO DELAY THE START OF A TIMED MODE:

1. Follow steps 1 through 4 above.
2. Touch TIME again and **STOPTIME** will appear in display and clock time display will begin flashing.

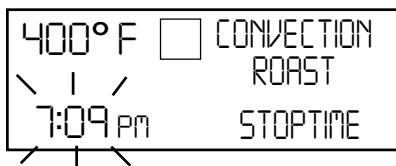

3. Use knob to enter the time of day the oven will stop cooking or turn off.

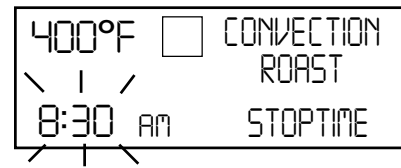

4. Touch **START**.
5. The clocktime will be displayed and **DELAY** appears in the display.



6. The clock automatically calculates the time of day at which the mode starts and stops. The displayed cooking time counts down by the minute.
 - The oven turns on and heats to the temperature selected for the number of hours and minutes needed.

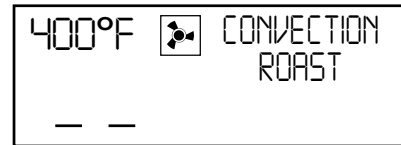

7. At the end of the programmed cooking time, the oven will automatically turn off. Display will show **OFF** and the oven will beep. Reminder beeps will sound for up to fifteen minutes until any pad is touched.
8. To check the cooking time and stop time after a delay has been set, touch COOKING MODE.

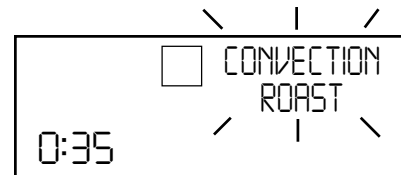

- The cooking mode will flash in the display and the set cooking time will be displayed.
- Touch TIME three times and **STOP TIME** will appear in display and the time-of-day the oven will stop cooking can be seen.
- Touch START to return to **DELAY** display.

Bake Tips and Techniques

Baking is cooking with heated air. Both upper and lower elements in the oven are used to heat the air but no fan is used to circulate the heat.

Follow the recipe or convenience food directions for baking temperature, time and rack position. Baking time will vary with the temperature of ingredients and the size, shape and finish of the baking utensil.

General Guidelines

- For best results, bake food on a single rack with at least 1" space between utensils and oven walls.
- Use a maximum of two racks when selecting the bake mode. Stagger pans or baking sheets so that one is not directly above another.

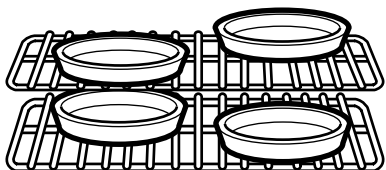

Staggered pans

- Check for doneness at the minimum time.
- Use metal bakeware (with or without a nonstick finish), heatproof glass, glass-ceramic, pottery or other utensils suitable for the oven.
- When using heatproof glass, reduce temperature by 25°F from recommended temperature.
- Use baking sheets with or without sides or jelly roll pans.
- Dark metal pans or nonstick coatings will cook faster with more browning. Insulated bakeware will slightly lengthen the cooking time for most foods.
- For best results, bake food on a single rack with at least 1-1/2" space between utensils and oven walls.
- Do not use aluminum foil or disposable aluminum trays to line any part of the oven. Foil is an excellent heat insulator and heat will be trapped beneath it. This will alter the cooking performance and can damage the finish of the oven.
- Avoid using the opened door as a shelf to place pans.
- *Tips for Solving Baking Problems* is found on Page 38.

Bake Cook Chart

Do not reduce recipe temperature.

Food Item	Oven Temperature	Rack Position	Time (minutes)
Breads			
Biscuits, scratch	450°F (232°C)	2	10 to 12
Biscuits, canned			
Large	375°F (190°C)	2	11 to 15
Medium	400°F (205°C)	2	8 to 11
Dinner Rolls	375°F (190°C)	2	11 to 13
Muffins	425°F (219°C)	2	15 to 20
Quick Breads	375°F (190°C)	2	40 to 60
Cakes			
Cake Mix,			
8" or 9" round(s)	350°F (177°C)	2	30 to 35
9" x 13" rectangle	350°F (177°C)	2	34 to 35
Cakes, Specialty			
Cupcakes	350°F (177°C)	2	19 to 22
Pound Cakes	350°F (177°C)	2	48 to 52
Carrot Cake, scratch	350°F (177°C)	2	30 to 45
Casseroles			
9" x 13", scratch	350°F (177°C)	2	30 to 45
Cookies			
Drop	350°F (177°C)	2	9 to 11
Brownies,			
Choc. Cream Cheese	350°F (177°C)	2	35 to 40
Choc. Raspberry	350°F (177°C)	2	22 to 27
Desserts			
Pies, pumpkin			
Scratch, <i>Step 1</i>	425°F (219°C)	2	15
Scratch, <i>Step 2</i>	350°F (177°C)	2	40 to 50
Frozen	400°F (205°C)	2	65 to 75
Fruits and Vegetables			
Apples, Baked (4)	375°F (190°C)	2	40 to 45
Potatoes, Baked (4)	400°F (205°C)	2	60 to 70
6 to 8 oz. each			

Convection Bake Tips and Techniques

- Reduce recipe baking temperatures by 25°F.
- For best results, foods should be cooked uncovered, in low-sided pans to take advantage of the forced air circulation. Use shiny aluminum pans for best results unless otherwise specified
- Heatproof glass or ceramic can be used. Reduce temperature by another 25°F when using heatproof glass dishes for a total reduction of 50°F.
- Dark metal pans may be used. Note that food may brown faster when using dark metal bakeware.
- The number of racks used is determined by the height of the food to be cooked.
- Baked items, for the most part, cook extremely well in convection. Don't try to convert recipes such as custards, quiches, pumpkin pie, or cheesecakes, which do not benefit from the convection-heating process. Use the regular Bake mode for these foods.
- Multiple rack cooking for oven meals is done on rack positions 1, 2 and 3. All four racks can be used for cookies, biscuits and appetizers.
- Converting your own recipe can be easy. Choose a recipe that will work well in convection.
- Reduce the temperature and cooking time if necessary. It may take some trial and error to achieve a perfect result. Keep track of your technique for the next time you want to prepare the recipe using convection.
- Tips for Solving Baking Problems are found on Page 38.

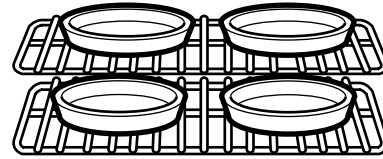

Pans do not need to be staggered.

Foods recommended for CONVECTION BAKE mode:

Appetizers
Biscuits
Coffee Cakes
Cookies (2 to 4 racks)
Yeast Breads
Cream Puffs
Popovers
Casseroles and One-Dish Entrees
Oven Meals (rack positions 1, 2, 3)
Air Leavened Foods (Soufflés, Meringue,
Meringue-Topped Desserts, Angel Food
Cakes, Chiffon Cakes)

QUICK AND EASY RECIPE TIPS

Converting from standard **BAKE** to **CONVECTION BAKE**:

- Reduce the temperature by 25°F.
- Use the same baking time as Bake mode if under 10 to 15 minutes.
- Foods with a baking time of less than 30 minutes should be checked for doneness 5 minutes earlier than in standard bake recipes.
- If food is baked for more than 40 to 45 minutes, bake time should be reduced by 25%.

Convection Bake Chart

Reduce standard recipe temperature by 25°F for Convection Bake.
Temperatures have been reduced in this chart.*

Food Item	Oven Temperature*	Rack Position	Time (minutes)
Breads			
Biscuits, scratch	425°F (219° C)	2	10 to 12
Biscuits, canned			
Large	350°F (177°C)	2	11 to 15
Medium	375°F (190°C)	2	8 to 11
Dinner Rolls	350°F (177°C)	2	11 to 13
Quick Breads	375°F (190°C)	2	40 to 60
White Bread, loaf	350°F (177°C)	2	25 to 30
Cakes			
Angel Food Mix	325°F (163°C)	1	37 to 47
Cookies			
Bar	350°F (177°C)	2	25 to 35
Drop	350°F (177°C)	1 & 3 or 1 to 4	11 to 14
Sliced	350°F (177°C)	2	11 to 14
Desserts			
Fruit Crisps and Cobblers			
Scratch	350°F (177°C)	2	40 to 50
Frozen (16 oz.)	400°F (205°C)	2	50 to 55
(32 oz.)	375°F (190°C)	2	50 to 60
Pies, scratch, 2 crust fruit	350°F (177°C)	2	60 to 70
Pies, frozen, 2 crust fruit	375°F (190°C)	2	60 to 75
Turnovers, frozen	Preheat to 450°F (232°C) Bake at 375°F (190°C)	2	20 to 25
Pastry Crust			
Scratch	425°F (219°C)	2	8 to 10
Refrigerator	425°F (219°C)	2	9 to 11
Pizza			
Scratch	425°F (219°C)	2	15 to 20
Frozen	375°F (190°C)	2	19 to 23
Specialty Breads			
Popovers	400°F (205°C)	2	38 to 42

*This chart is a guide. Follow recipe or package directions and reduce temperatures appropriately.

Convection Roast Tips and Techniques

- Preheat for Convection Roast.
- Roast in a low-sided, uncovered pan.
- When roasting whole chickens or turkey, tuck wings behind back and loosely tie legs with kitchen string.
- Use the 3-piece broil pan for roasting uncovered.
- Use the probe or a meat thermometer to determine the internal doneness on “END” temperature (see cooking chart).
- Double-check the internal temperature of meat/poultry by inserting meat thermometer into another position.
- When roasting a large roast or turkey, roasting pan may need to be rotated during roasting time. This will allow for more even cooking. Large birds may also need to be covered with foil (and pan roasted) during a portion of the roasting time to prevent over-browning.

QUICK AND EASY RECIPE TIPS

Converting from standard **BAKE**
to **CONVECTION ROAST**:

- Temperature does not have to be lowered.
 - Roasts, large cuts of meat and poultry generally take 10-20% less cooking time. Check doneness early.
 - Casseroles or pot roasts that are baked covered in **CONVECTION ROAST** will cook in about the same amount of
- The minimum safe temperature for stuffing in poultry is 165°F (74°C).
 - After removing the item from the oven, cover loosely with foil for 10 to 15 minutes before carving.
 - While covered, roast temperatures increase by 5° to 10°F.

Convection Roasting with the Probe

- The meat probe can be used to determine the internal doneness or the “END” temperature (see cooking chart, Page 23).
- The temperature range for the probe is 130°F to 210°F (55°C to 100°C). The probe automatic default temperature is programmed at 170°F (77°C) but can be set for your recipe.
- Preheating the oven for Convection Roast is not recommended when using the probe. A hot oven will impair your ability to easily connect the probe to the receptacle and into the meat.

TO USE THE PROBE

1. Prepare meat and place in roasting pan (or on rack in roasting pan as recipe specifies). Insert the probe into the thickest center portion of the meat.
2. Make sure the probe is not touching fat, bone, the roast rack or the pan.
3. Place roasting pan with meat in cold oven on recommended oven rack. Plug probe into the probe receptacle. The probe symbol will appear in display.
4. Touch COOKING MODE and select Convection Roast. **CONVECTION ROAST** will flash and the default temperature will appear.

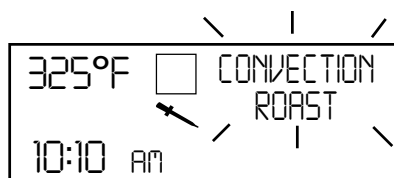

Convection Roasting with the Probe, continued

5. Touch TEMPERATURE and displays for probe temperature and probe symbol will flash.

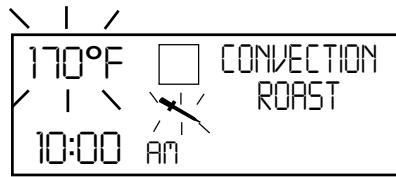

6. To change the probe temperature, rotate knob. Temperatures can be changed by 5°F increments. Probe symbol will continue to flash.

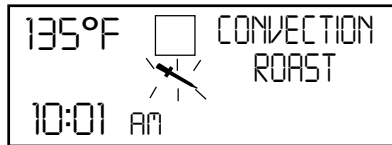

7. To select oven-roasting temperature, touch TEMPERATURE again. Roasting default temperature will flash in display.

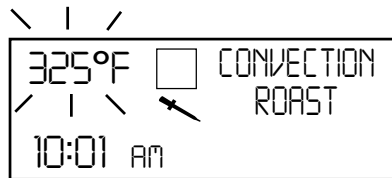

8. To select roasting temperature, rotate knob. Roasting temperature can be changed by 5°F increments.

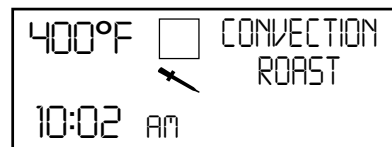

9. Touch START. If START is not touched, oven will beep as a reminder to touch START and roasting temperature will flash in display. **PRESS START** will appear in display.

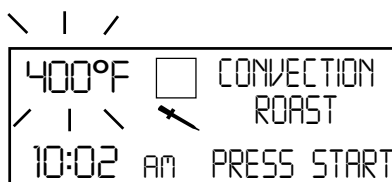

Convection Roasting with the Probe, continued

- The temperature displayed is the meat probe temperature. The probe temperature display will increase in 5°F increments until the set temperature is reached.

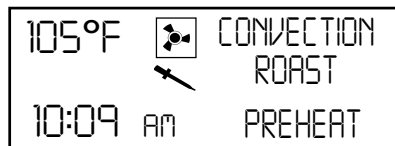

- The oven is preheated when the chime signals once. **PREHEAT** disappears from the display.

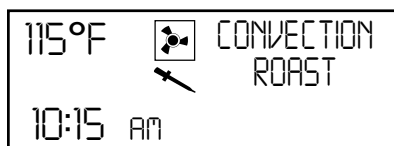

- TEMPERATURE can be touched during roasting to toggle between the probe temperature and the oven roasting temperature.
- When the set probe temperature is reached, **OFF** will appear in display as oven turns off.
- To change probe temperature, simply touch TEMPERATURE. Probe temperatures will flash in the display. Turn the knob to desired temperature and press START.
- To change oven temperature, simply touch TEMPERATURE two times. **OVEN TEMPERATURE** will flash in the display. Turn the knob to desired temperature and press START.

NOTE:

The probe symbol will remain in display, as a reminder to remove it from oven when roasting is complete. Do not leave probe attachment in oven when using oven for other cooking applications or during self-clean.

Convection Roast Chart

Meat and Poultry – Uncovered Pan	Oven Temperature	Rack	Cook Time	Probe Temperature	Doneness	Carving Temperature
Beef: Standing Rib 3 to 6 lbs. 6 to 9 lbs.	325°F (163° C)	2	<u>Minutes Per lb.</u> 28 to 32	135°F (57° C) 140°F (60° C) 160°F (71° C)	Med Rare Med Well	145°F (63° C) 150°F (66° C) 170°F (77° C)
Boneless rib 1 to 4 lbs.	325°F (163° C)	2	30 to 33	135°F (57° C) 140°F (60° C) 160°F (71° C)	Med Rare Med Well	145°F (63° C) 150°F (66° C) 170°F (77° C)
Sirloin, boneless Rump, eye 3 to 6 lbs.	325°F (163° C)	2	30 to 33	135°F (57° C) 140°F (60° C) 160°F (71° C)	Med Rare Med Well	145°F (63° C) 150°F (66° C) 170°F (77° C)
Tri-Tip Tenderloin 1-1/2 to 3 lbs.	425°F (219° C)	2	<u>Total Time</u> 30 to 40 min. 35 to 45 min.	135°F (57° C) 140°F (60° C) 160°F (71° C)	Med Rare Med Well	145°F (63° C) 150°F (66° C) 170°F (77° C)
Chicken: 3 to 5 lbs.			<u>Minutes Per lb.</u>		<u>Probe Locations</u>	
Unstuffed	375°F (190° C)	3	18 to 21	175°F (79° C)	Thigh	175°F (79° C)
Stuffed*	350°F (177° C)	3	18 to 21	175°F (79° C)	Thigh	165°F (74° C)
Pieces	375°F (190° C)	3	<u>Total Time</u> 60 minutes	165°F (74° C) 175°F (79° C)	Breast Thigh	170°F (77° C) 175°F (79° C)
Cornish Game Hens	350°F (177° C)	2	<u>Total Time</u> 60 to 90 minutes	180°F (82° C)	Breast and thigh	180°F (82° C)
Meatloaf 1 to 2 lbs.	350°F (177° C)	2	<u>Total Time</u> 60 to 75 minutes	170°F (77° C)	Well	170°F (77° C)
Lamb: Leg 4 to 8 lbs.	325°F (163° C)	1	<u>Minutes Per lb.</u> 24 to 30	135°F (57° C)	Med Rare	145°F (63° C)
Rack of Lamb 1 to 3 lbs.	325°F (163° C)	1	30 to 35	135°F (57° C)	Med Rare	145°F (63° C)
Pork: Loin 4 to 6 lbs.	325°F (163° C)	2	<u>Minutes Per lb.</u> 32 to 35	155°F (68° C)	Well	160°F (71° C)
Shoulder 3 to 5 lbs.	325°F (163° C)	2	32 to 35	155°F (68° C)	Well	160°F (71° C)
Turkey: Whole, 8 to 15 lbs.			<u>Minutes Per lb.</u>		<u>Probe Locations</u>	
Unstuffed	325°F (163° C)	2	9 to 12	170°F (77° C)	Thigh	175°F (79° C)
Stuffed*	300°F (149° C)	2	10 to 15	170°F (77° C)	Thigh	175°F (79° C)
Whole 16 to 24 lbs.						
Unstuffed	325°F (163° C)	1	7 to 11	170°F (77° C)	Thigh	175°F (79° C)
Stuffed*	300°F (149° C)	1	10 to 12	170°F (77° C)	Thigh	175°F (79° C)
Breast, with bone 5 to 7 lbs.	325°F (163° C)	2	16 to 21	165°F (74° C)	Breast	170°F (77° C)
Veal: Loin (bone in) 2 to 4 lbs.	325°F (163° C)	2	<u>Minutes Per lb.</u> 32 to 34	155°F (68° C)	Well	160°F (71° C)

* The minimum safe temperature for stuffing in poultry is 165°F (74°C)

Broil Tips and Techniques

- Place rack in the required position needed before turning on the oven.
- Start broiling with a cool oven and broiler pan. There is no need to preheat oven for broiling.
- Broil with the oven door positioned at the Broil door stop (open door broiling).
- Use the three-piece broil pan for Broil.
- Brush fish and lean cuts of meat with vegetable oil before broiling to prevent sticking.
- Start broiling poultry with skin side down.
- Turn food after one half of total cooking time. Thicker cuts of meat or poultry can be turned more often.
- Slotted top racks on broiler pan let fat drip away, reducing spattering and smoking.
- When top-browning casseroles, use only metal or glass-ceramic (Pyroceram™) such as Corningware® bakeware.
- Never use heat-proof glass (Pyrexware®) pottery; they cannot tolerate the high temperatures.
- Refer to Page 14 for setting Broil mode.

Broil Chart

Food Item and Thickness	Rack Position	Broil Setting	Broil Total Time (minutes)
Beef: Ground, patties, 3/4" to 1"	3	5	Med Rare: 6 to 7 Med: 8 to 9 Well: 9 to 10
Steaks, 3/4" to 1-1/4"	3	5	Rare: 3 to 4 Med: 4 to 5 Well: 5 to 6
Bread: Garlic Bread, 1/2" slices	3 or 4	5	2-1/2 to 4
3/4" to 1" slices	3 or 4	5	4 to 5
Fish: Fillets or steaks, 1/2" to 1"	3	4	Flakes: 8 to 12 (1/2" thickness does not need to be turned after half of broil time)
Lamb: Chops, 1/2" to 1"	3	5	Med: 12 to 17 Well: 15 to 20
Pork: Chops, 1/2" to 1"	3	4	Well: 18 to 25
Smoked Ham Steak, 1/2"	3	5	Well: 7 to 11
Ham Steak, 1"	3	5	Well: 12 to 15
Poultry: Chicken, pieces	3	5	30 to 45
Sausage: Hot Dogs, whole	4	5	4 to 5
Veal: Chop, 1"	3	5	Well: 12 to 16

Convection Broil

- Place rack in the required position needed before turning on the oven.
- Use Convection Broil mode with the oven door closed (closed door broiling).
- Oven can be preheated for Convection Broil.
- Use the 3-piece broil pan for Convection Broil.
- Meats may be brushed with cooking oil to prevent sticking.
- Thicker cuts of meat will cook in less time when using Convection Broil rather than in standard Broil.
- Refer to Page 14 for setting Convection Broil mode.

Convection Broil Chart

Food Item and Thickness	Rack Position	Broil Setting	Convection Broil Total Time (minutes)
Beef: Roasts, flat, 1-1/2" or more Steaks, 1-1/2" or more Hamburgers, 1-1/2" thick	3 3 3	500°F (260° C) 500°F (260° C) 500°F (260° C)	Med Rare: 6 to 7 Med: 7 to 8 Well: 10 to 11 Med Rare: 6 to 7 Well: 9 to 10
Bread: Garlic Bread, 1-1/2" slices	3 or 4	500°F (260° C)	4 to 6
Lamb: Chops, 1-1/4" or more	3	500°F (260° C)	Rare: 8 to 9 Med: 10 to 11
Pork: Chops or Tenderloin, 1-1/4" or more	3	500°F (260° C)	Well: 15 to 24
Poultry: Chicken, quarters Turkey, pieces	3 3	450°F (232° C) 450°F (232° C)	30 to 45 30 to 50
Sausages: Fresh, uncooked	4	550°F (288° C)	Well: 6 to 8

Dehydrate Tips and Techniques

- Dehydrating can be done using the Dehydrate mode. A lower temperature is used and the circulating heated air slowly removes the moisture for food preservation.
- The Dehydrate mode temperature is preprogrammed at 140°F (60°C).
- The Dehydrate mode temperatures available are 120°F (49°C) to 160°F (71°C).
- Multiple racks can be used simultaneously.
- Some foods require as much as 14-15 hours of time to fully dehydrate.
- Consult a food preservation book for specific times and the handling of various foods.
- This mode is suitable for a variety of fruits, vegetables, herbs and meat strips.
- Drying screens can be purchased at specialty kitchen shops.
- By using paper towels, some food moisture can be absorbed before dehydrating begins (such as with sliced tomatoes or sliced peaches).

Warming Tips and Techniques

- Call on your oven Warming mode to keep foods hot until you are ready to serve them.
- The Warming mode default temperature is preprogrammed at 170°F (75°C).
- Warming mode temperatures available are 100°F to 210°F (38°C to 99°C).
- Recommended safe temperatures for keeping foods hot are between 140°F and 210°F (66°C to 99°C). Use the chart below as a guide.
- Foods needing to be kept moist should be covered with a lid or aluminum foil.

SUGGESTED TEMPERATURE TO KEEP FOODS HOT USING THE WARMING MODE

140° - 200°F (66° - 94°C)	200° - 210°F (94° - 99°C)
Appetizers and Nachos Biscuits Casseroles Fish, Seafood Roasts (Med. to Med.Well) Pork Muffins Pastries, Pies Potatoes, Vegetables	French Fries Pancakes Pizza Waffles

Proofing and Defrosting Tips and Techniques

- The Warming mode may be used for proofing (rising) yeast dough and for defrosting.
- Set the oven to 100°F (38°C) for proofing dough or for defrosting frozen foods.
- For proofing yeast dough, loosely cover the bowl or pan and use any rack that accommodates the size of the bowl or pan.
- Keep the oven door closed and use oven light to check the rising of the dough.
- Use the reminder of the oven Timer to check the proofing of dough or defrosting of food.

Special Features

The Special Features function can be used to select the following 10 special oven features:

1. **LOCK KEYS** (Child Lockout)
2. **SABBATH MODE** (for religious faiths with “no work” requirements on the Sabbath)
3. **OVEN OFFSET 1** (upper oven – used to calibrate the oven temperature)
4. **OVEN OFFSET 2** (lower oven – used to calibrate the oven temperature)
5. **LANGUAGE** (select English, Spanish, or French)
6. ° **SELECT UNITS** (switch temperature scale to Fahrenheit or Centigrade)
7. **CLOCK FORMAT** (12 hr or 24 hr)
8. **BEEP VOLUME** (decrease or increase loudness of oven beeps)
9. **VIEW CLOCK** (yes or no)
10. **DEFAULT DATA** (change *all* feature settings back to original factory settings)

To select special features, follow the steps below:

- a. Touch and hold COOKING MODE for 3 seconds.
- b. Clock time disappears and display screen clears.
- c. The four display screen messages shown below will automatically appear, one after the other.

**OVEN SETTINGS
HELP SCREENS
PLEASE READ**

**TO EXIT AND
LOSE CHANGES
PRESS CANCEL**

**TO EXIT AND
KEEP CHANGES
PRESS START**

**TO BEGIN
TURN KNOB
THANK YOU**

Tips on Using Special Features:

- There will be a **slight delay** before each message (or feature) can be seen in the display.
- Turn knob **slowly**, one click then wait approximately one second for display to show next feature. Turn knob one more click and pause for next feature.
- When selecting a feature, the display will read **PRESS MODE TO SELECT**.
- To move through the feature menu, **slowly** turn the knob clockwise one click after each feature appears.

FEATURE #1 – LOCK KEYS (YES or no)

1. Select Special Features.
2. Turn knob clockwise **slowly** until **LOCK KEYS** is displayed.
3. Touch COOKING MODE.
4. Turn knob once and **YES** will appear in screen.
5. Touch COOKING MODE to hold new selection.
6. Touch START to accept new setting.
7. If a pad is now touched, display will read **KEYS LOCKED**.
8. To unlock keypads, touch COOKING MODE and hold for 5 seconds.
 - Display will now read **KBD UNLOCKED** (keypads unlocked).
 - This feature can be used as the child lock-out feature.

no LOCK KEYS

Special Features, continued

FEATURE #2 – SABBATH MODE (YES or no)

1. Select Special Features.
 2. Turn knob clockwise **slowly** until **SABBATH MODE** is displayed.
 3. Touch COOKING MODE.
 4. Turn knob once and **YES** will appear in screen.
 5. Touch COOKING MODE to **hold** new selection.
 6. Touch START to **accept** Sabbath mode.
- Sabbath mode uses only the Bake mode (no convection or broil modes can be used; no timed bake or probe mode can be used).

WHEN SABBATH MODE FEATURE HAS BEEN SET AND YOU WISH TO USE THE MODE

1. Touch COOKING MODE.
 2. Turn knob until **SABBATH** appears in display.
 3. Touch TEMPERATURE if a different temperature is needed and turn knob to select temperature.
 4. Touch START and oven will begin operating in the Sabbath mode.
- Oven lights will remain on or off as previously set, even if the door is open or closed.
 - **PREHEAT** will not show in display.
 - All pads, except the UPPER CANCEL or LOWER CANCEL, will be inactive.
 - No beep signal is generated.
 - Oven will remain on indefinitely until UPPER CANCEL or LOWER CANCEL is touched.
 - This mode can remain active indefinitely for use when required.



FEATURE #3 – OVEN OFFSET I (upper oven)

- This feature calibrates oven temperatures.
- The electronic thermostat has been preset to 0°F and accurately maintains its setting.
- If browning results are too light or too dark for your preferences, you can raise or lower the setting.
- If oven temperature is not hot enough, temperature can be increased.
- If oven is too hot, temperature can be decreased.
- Temperature is changed in 5°F increments.
- Temperature ranges available for offsets in Fahrenheit are from 0° to +35° or –35° (or Centigrade 0° to +20° or -20°).

TO CHANGE OVEN OFFSET

1. Select Special Features.
2. Turn knob clockwise **slowly** until **OVEN OFFSET I** is displayed.
3. Touch COOKING MODE.
4. Turn the knob to the right to increase temperature and to the left to decrease temperature.
5. Touch COOKING MODE to **hold** new selection.
6. Touch START to **accept** a temperature change.

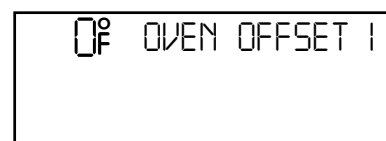

FEATURE #4 - OVEN OFFSET 2 (lower oven)

1. Refer to Feature #3 above for **OVEN OFFSET I** (upper oven). Substitute Step 2, below.
2. Turn knob clockwise **slowly** until **OVEN OFFSET 2** is displayed.

Special Features, continued

FEATURE #5 – LANGUAGE

- Language choices are English (**EnG**), Spanish (**ESP**), and French (**FrA**).
- When first installed, **ENGLISH** appears in the display.

TO CHANGE THE LANGUAGE

1. Select Special Features.
2. Turn knob clockwise slowly until **LANGUAGE** is displayed.
3. Touch COOKING MODE.
4. Turn knob clockwise to select a different language
5. Touch COOKING MODE to hold new selection.
6. Touch START to accept a language change.



ENG LANGUAGE

FEATURE #6 - ° SELECT UNITS

- The oven has been preset to the Fahrenheit temperature scale.
- The feature allows you to switch between Fahrenheit and Centigrade temperature.

TO CHANGE THE TEMPERATURE SCALE

1. Select Special Features.
2. Turn knob clockwise slowly until ° **SELECT UNITS** is displayed.
3. Touch COOKING MODE.
4. Turn knob to select Fahrenheit or Centigrade.
5. Touch COOKING MODE to hold new selection.
6. Touch START to accept new selection.



° SELECT UNITS
F

FEATURE #7 – CLOCK FORMAT (12 hr or 24 hr)

- The clock can be set to a 12-hr or 24-hr format.
- The oven default for clock format is 12-hr.

TO CHANGE THE CLOCK FORMAT

1. Select Special Features.
2. Turn knob clockwise slowly until **CLOCK FORMAT** is displayed.
3. Touch COOKING MODE.
4. Turn knob to select 12-hr or 24-hr format.
5. Touch COOKING MODE to hold new selection.
6. Touch START to accept new selection.



12 hr CLOCK FORMAT

Special Features, continued

FEATURE #8 – BEEP VOLUME

- The volume of the oven beep can be changed from 1 (softest) to 3 (loudest).
- The oven default for beep volume is 2.

TO CHANGE THE BEEP VOLUME

1. Select Special Features.
2. Turn knob clockwise **slowly** until **BEEP VOLUME** is displayed.
3. Touch COOKING MODE.
4. Turn knob to select volume level (1, 2 or 3).
5. Touch COOKING MODE to **hold** new selection.
6. Touch START to **accept** new selection.

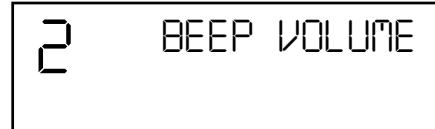

FEATURE #9 – VIEW CLOCK (YES or no)

- Clock time display can be turned off.

TO TURN OFF THIS DISPLAY

1. Select Special Features.
2. Turn knob clockwise **slowly** until **VIEW CLOCK** is displayed.
3. Touch COOKING MODE.
4. Turn knob once and **no** will appear in display.
5. Touch COOKING MODE to **hold** new selection.
6. Touch START to **accept** new selection.

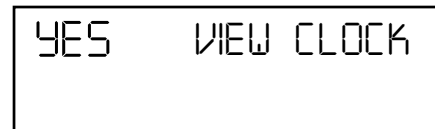

FEATURE #10 – DEFAULT DATA (YES or no)

- This feature is used to change all the special feature settings back to the original factory settings (or defaults).

TO CHANGE THE FEATURE SETTINGS TO ORIGINAL SETTINGS

1. Select Special Features.
2. Turn knob clockwise **slowly** until **DEFAULT DATA** is displayed.
3. Touch COOKING MODE.
4. Turn knob once and **YES** will appear in display.
5. Touch COOKING MODE to **hold** new selection.
6. Touch START to **accept** new selection.



Oven Care and Cleaning

SELF-CLEANING THE OVEN

Bosch ovens feature a pyrolytic self-cleaning function that eliminates the difficult and time consuming manual scrubbing of the oven interior. During self-cleaning, the oven uses a very high temperature (approx. 885°F) to burn away food soil and grease.

- Only one oven at a time can be set to Self-Clean.
- It is common to see smoke and/or an occasional flame-up during the Self-Clean cycle, depending on the content and amount of soil remaining in the oven. If a flame persists, turn off the oven and allow it to cool before opening the door to wipe up the excessive food soil.
- The door latch is automatically activated after selecting the Self-Clean cycle. The door lock symbol will appear in the display. This ensures that the door cannot be opened while the oven interior is at clean temperatures.
- The oven light does not operate during this mode.
- During Self-Clean, the kitchen should be well ventilated to help eliminate odors associated with Self-Clean. Odors will lessen with use.
- Three hours is the preset length of cleaning.
- The mode automatically stops at the end of the clean hours.
- When the oven heat drops to a safe temperature, the automatic door lock will release and the door can be opened.

PREPARING THE OVEN FOR SELF-CLEAN

1. Remove all utensils and bakeware.
2. Remove oven racks. If oven racks are left in the oven during the self-clean cycle, they will permanently lose the shiny finish and change to a dull dark finish. See *Oven Cleaning Chart* for proper care, Pages 33 to 34.
3. Wipe up any soft soil spills and grease with paper towels. Excess grease will cause flames and smoke inside the oven during self-cleaning.
4. Review illustration below. Some areas of the oven must be cleaned by hand before the cycle begins. They do not get hot enough during the cleaning cycle for soil to burn away. Use a soapy sponge or plastic scrubber or a detergent-filled S.O.S.[®] pad. Hand-clean the oven door edge, oven front frame and up to 1-1/2 inches inside the frame with detergent and hot water. Do not rub the gasket on oven. Hand-clean the oven door window. Rinse all areas thoroughly then dry.
5. Be sure oven interior lights are turned off and the light bulbs and lens covers are in place. See Pages 13 and 37.

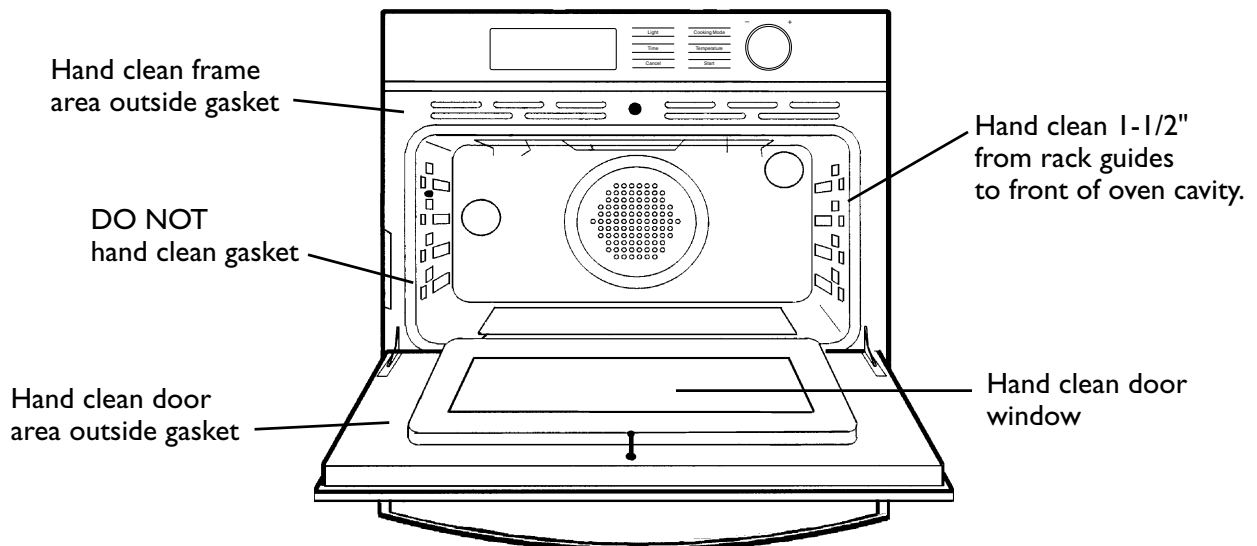

Setting the Self-Clean Mode

TO SET THE SELF-CLEAN MODE:

1. Touch UPPER/LOWER to select oven to be cleaned.
2. Touch COOKING MODE.
3. Rotate knob until **CLEAN** mode appears. The number of cleaning hours is displayed automatically.

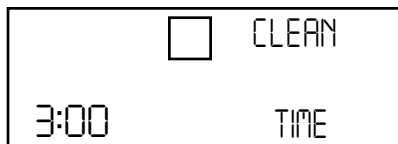

4. To change the setting from 3 hours, select either 2 hours for light soil or 4 hours for heavy soil immediately before starting.
 - To change hours, touch TIME twice.
 - Number of hours to clean will flash in display.

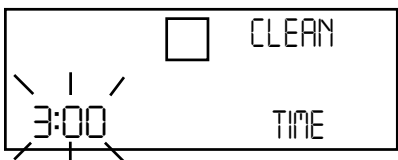

- Rotate knob to select number of hours.

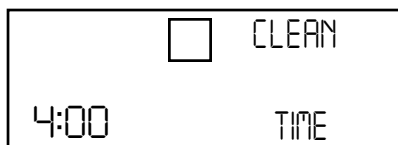

5. Touch START pad and **REMOVE RACKS** appears in the display as a reminder to remove oven racks.

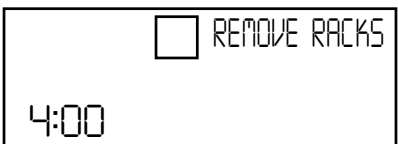

6. Touch START again. Do not attempt to open the door while the door is locking. Lock symbol will appear after a short delay. When the lock symbol is displayed, the door cannot be opened. Confirm that the door locks and will not open before starting Self-Clean mode.

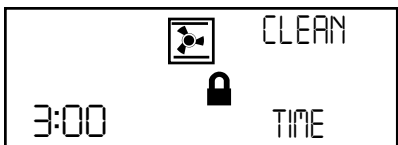

If door does not lock, press UPPER CANCEL or LOWER CANCEL and do not self-clean; phone 800/735-4328 for service (see Page 39 for obtaining service). If the door is in the open position when this mode is selected, **CLOSE DOOR** will appear in display.

7. At the end of the programmed cleaning time, the oven will automatically turn off.
8. To cancel or stop the mode after the lock symbol is displayed, touch UPPER CANCEL or LOWER CANCEL.

TO DELAY THE START OF THE MODE:

1. Follow steps 1 through 4 above.
2. Touch TIME pad again and clock time will begin flashing and **STOPTIME** will appear in display.

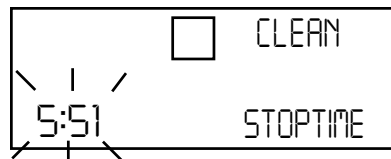

3. Use knob to enter a Stoptime.
4. Touch START once and display will remind you to remove oven racks.
5. Touch START to set the Delay mode.

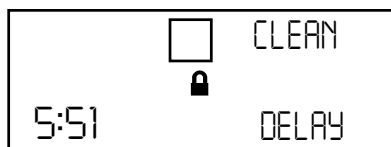

6. Oven door will lock and display shows **DELAY**.
7. At the end of the programmed cleaning time, the oven will automatically turn off.
8. To cancel or stop the mode after the lock (🔒) symbol is displayed, touch UPPER CANCEL or LOWER CANCEL.

TO CHECK CLEAN TIME FOR DELAYED SELF-CLEAN:

1. Touch TIME one time. **TIMER** will flash in display.
2. Turn knob slowly to the right and **TIME** will flash in display.
3. Touch TIME again and the actual clean time will appear in display.
4. After a short pause, the oven will automatically revert to the **DELAY** message in the display.

TO CHECK STOP TIME FOR DELAYED SELF-CLEAN:

1. Touch TIME one time. **TIMER** will flash in display.
2. Turn knob slowly to the left and **STOPTIME** will flash in display.
3. Touch TIME again and the actual stop time will appear in display.
4. After a short pause, the oven will automatically revert to the **DELAY** message in the display.

General Oven Care

How to use the Oven Cleaning Chart

1. Locate the number of the part to be cleaned in the illustration on this page.
2. Find the part name in the chart.
 - Use the cleaning method in the left column if the oven is black or white.
 - Use the cleaning method in the right column if the oven is stainless steel.
3. Match the letter with the cleaning method on Page 34.

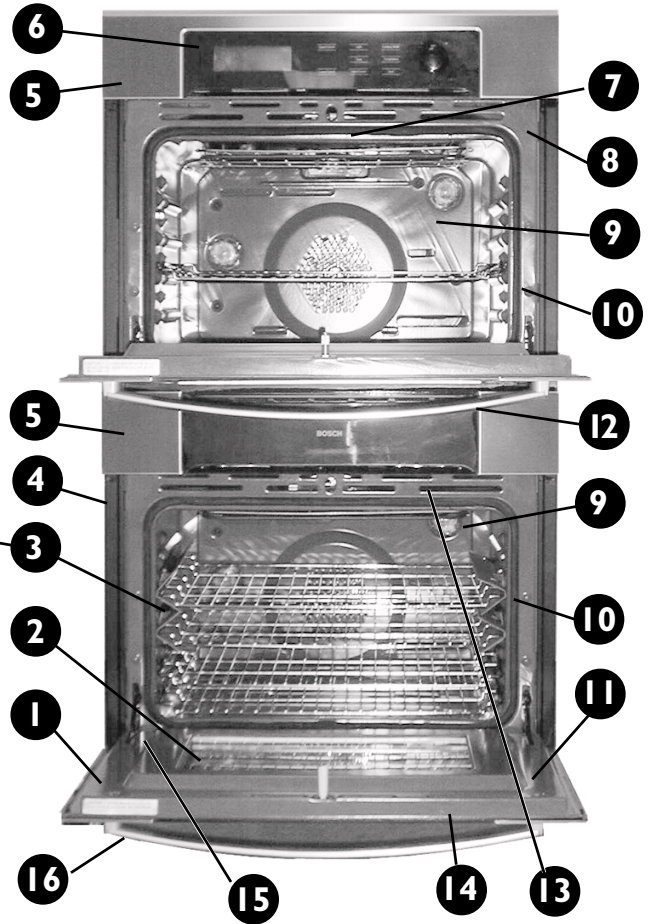
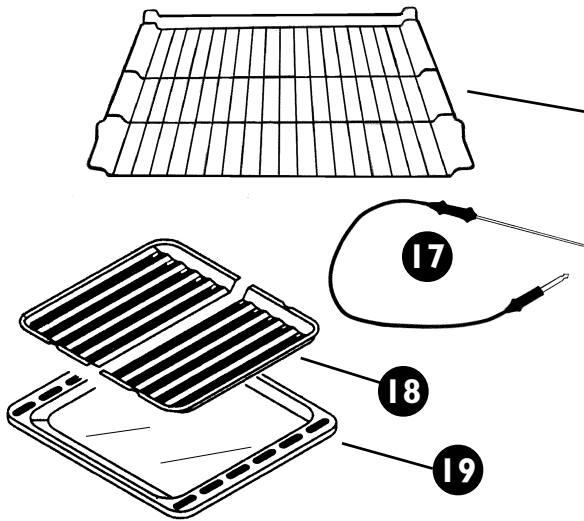

Part	Cleaning Method		Part	Cleaning Method	
	Blk / Wht Oven	Stainless Steel Oven		Blk / Wht Oven	Stainless Steel Oven
1 Door Frame	E	E	11 Interior Oven Door	E	E
2 Interior Door Window	F	F	12 Door Handle	D	D
3 Removable Oven Racks	A	A	13 Door Cooling Vent	E	E
4 Side Trim	D	D	14 Door Front	C & D	C & G
5 Control Panel Trim	C	G	15 Oven Trim	D	D
6 Control Panel	C	C	16 End Caps	D	D
7 Oven Cooling Vents	D	D	17 Probe Accessory	H	H
8 Oven Front Frame	E	E	18 Broil Pan Rack	E	E
9 Oven Cavity	E	E	19 Broil Pan Bottom	E	E
10 Mesh Gasket	B	B			

Oven Finishes / Cleaning Methods

The entire oven can be safely cleaned with a soapy sponge, rinsed and dried. If stubborn soil remains, follow the recommended cleaning methods below.

- Always use the mildest cleaner that will do the job.
- Rub metal finishes in the direction of the grain.
- Use clean, soft cloths, sponges or paper towels.
- Rinse thoroughly with a minimum of water so it does not drip into door slots.
- Dry to avoid water marks.

The cleaners listed below indicate types of products to use and are not being endorsed. Use all products according to package directions.

PART	CLEANING METHOD
A Chrome Plated	<p>Wash with hot sudsy water. Rinse thoroughly and dry. Or, gently rub with Soft Scrub[®], Bon-Ami[®], Comet[®], Ajax[®], Brillo[®] or S.O.S.[®] pads as directed. Easy Off[®] or Dow[®] Oven Cleaners (cold oven formula) can be used, but may cause darkening and discoloration.</p> <p>Racks may be cleaned in the oven during the self-clean mode. However, they will lose their shiny finish and permanently change to a metallic gray.</p>
B Fiberglass Knit	DO NOT HAND CLEAN GASKET.
C Glass	Spray Windex [®] or Glass Plus [®] onto a cloth first, then wipe to clean. Use Fantastik [®] or Formula 409 [®] to remove grease spatters.
D Painted	Clean with hot sudsy water or apply Fantastik [®] or Formula 409 [®] first to a clean sponge or paper towel and wipe clean. <u>Avoid using powdered cleansers and steel wool pads.</u>
E Porcelain	Immediately wipe up acid spills like fruit juice, milk and tomatoes with a <u>dry</u> towel. Do not use a moistened sponge/towel on hot porcelain. When cool, clean with hot sudsy water or apply Bon-Ami [®] or Soft Scrub [®] to a damp sponge. Rinse and dry. For stubborn stains, gently use Brillo [®] or S.O.S. [®] pads. It is normal for porcelain to craze (fine lines) with age due to exposure from heat and food soil.
F Reflective Glass	Clean with hot sudsy water and sponge or plastic scrubber. Rub stubborn stains with vinegar, Windex [®] , ammonia or Bon-Ami [®] . DO NOT USE HARSH ABRASIVES.
G Stainless Steel	Always wipe or rub with grain. Clean with a soapy sponge then rinse and dry. Or, wipe with Fantastik [®] or Formula 409 [®] sprayed onto a paper towel. Protect and polish with Stainless Steel Magic [®] and a soft cloth. Remove water spots with a cloth dampened with white vinegar. Use Zud [®] , Cameo [®] , Bar Keeper's Friend [®] or RevereWare Stainless Steel Cleaner [®] , to remove heat discoloration.
H Probe	Clean probe by hand with detergent and hot water. Then rinse and dry. Do not soak or clean in dishwasher.

Do-It-Yourself Maintenance

Oven Door Removal

⚠ WARNING

- Make sure oven is cool and power to the oven has been turned off before removing the door. Failure to do so could result in electrical shock or burns.
- The oven door is heavy and fragile. Use both hands to remove the oven door. The door front is glass. Handle carefully to avoid breakage.
- Grasp only the sides of the oven door. Do not grasp the handle as it may swing in your hand and cause damage or injury.
- Failure to grasp the oven door firmly and properly could result in personal injury or product damage.

To remove the door for 30" models HBL7.....

1. Be sure to read the above WARNING before attempting to remove oven door.
2. Open the door completely.
3. Lift up the hinge bracket on each hinge as shown in Figure A, below.

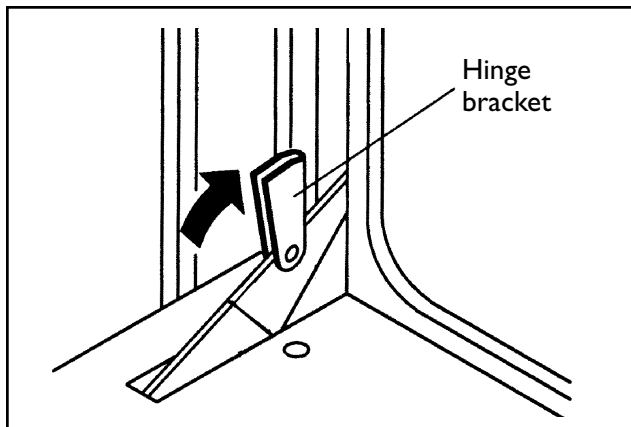

FIGURE A

4. Hold the door firmly on both sides using both hands. Slightly lift the door then pull the door straight out of the hinge slots. Hold firmly, the door is heavy.
5. Place the door in a convenient and stable location for cleaning.

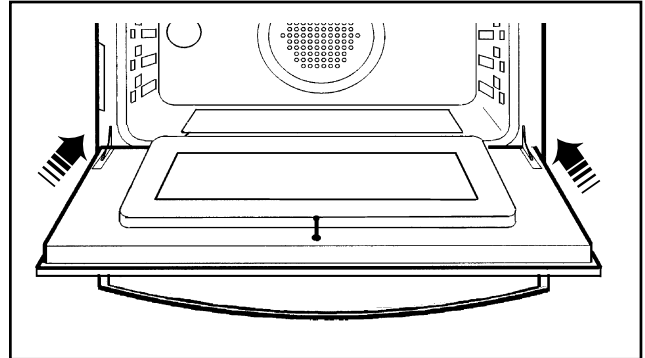

Figure B

To Replace the Oven Door

- The door can be replaced by reversing the above procedure.
- Be sure to slide the door straight into the slots as shown in Figure B, above.
- After moving the hinge brackets back down into position, be sure to close and open the door slowly to assure that it is correctly and securely in place.

Oven Door Removal, continued

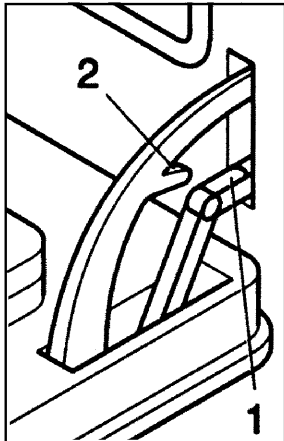

Figure C

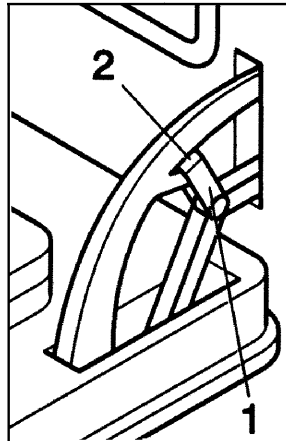

Figure D

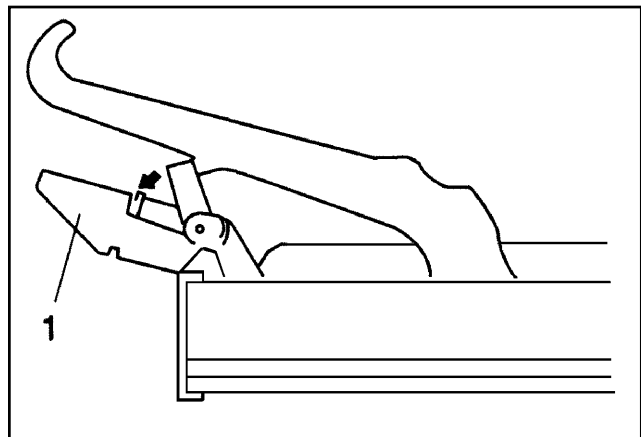

Figure E

To remove the door for 27" models HBN7....

1. Be sure to read the above WARNING before attempting to remove oven door.
2. Open the door completely.
3. Lift up the hinge bracket (1, Figure C) into the slot (2, Figures C and D) above.
4. Hold the door firmly on both sides using both hands and partially close the door. Hold firmly and remove the door. Be careful as door is heavy.
5. Place the door in a convenient location for cleaning.

After cleaning, the door can be replaced by reversing the above procedure. Be sure to slide the hinge parts into their slots properly. See Figures C, D and E.

After moving the hinge brackets back down into position, be sure to close and open the door slowly to assure that it is correctly and securely in place.

Replacing an Oven Light

- Each oven is equipped with two halogen lights located in the back wall of the oven.
- The lights are switched on when the door is opened or when the oven is in a cooking cycle.
- The oven lights are not illuminated during SELF-CLEAN.
- Each light assembly consists of a removable lens, a light bulb as well as a light socket housing that is fixed in place. See Figure F.
- Light bulb replacement is considered to be a routine maintenance item.

To replace a light bulb:

1. Read WARNING on this page.
2. Turn off power at the main power supply (fuse or breaker box).
3. In convection ovens, remove the fan cover by unscrewing the four screws.
4. Remove the lens by unscrewing it.
5. Remove the light bulb from its socket by pulling it.
6. Replace the bulb with a new one. Avoid touching the bulb with fingers, as oils from hands can damage the bulb when it becomes hot.
7. The bulb is halogen 12V-20W.
8. Screw the lens back on.
9. Replace the fan cover if it is provided with the oven model.
10. Turn power back on at the main power supply (fuse or breaker box).

⚠ WARNING

- **Make sure the oven and lights are cool and power to the oven has been turned off before replacing the light bulb(s). Failure to do so could result in electrical shock or burns.**
- **The lenses must be in place when using the oven.**
- **The lenses serve to protect the light bulb from breaking.**
- **The lenses are made of glass. Handle carefully to avoid breakage. Broken glass could cause an injury.**

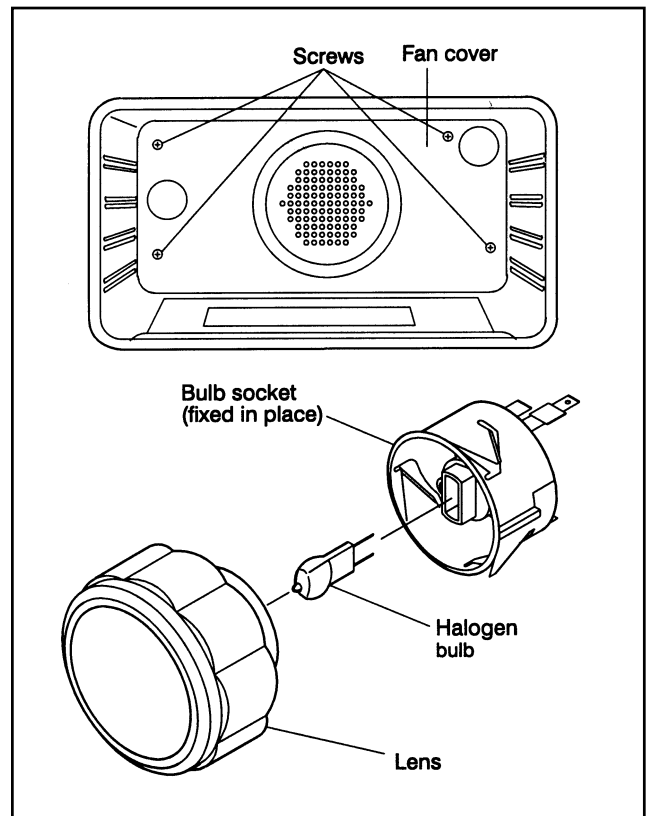

Figure F

Solving Baking Problems

With either Bake or Convection Bake, poor results can occur for many reasons other than a malfunction of the oven. Check the chart below for causes of the most common problems. Since the size, shape and material of baking utensils directly affect the baking results, the best solution may be to replace old baking utensils that have darkened and warped with age and use. Check the Baking Charts on Pages 17 and 19 for the correct rack position and baking time.

BAKING PROBLEM	CAUSE
Food browns unevenly	<ul style="list-style-type: none"> • Oven not preheated • Aluminum foil on oven rack or oven bottom • Baking utensil too large for recipe • Pans touching each other or oven walls
Food too brown on bottom	<ul style="list-style-type: none"> • Oven not preheated • Using glass, dull or darkened metal pans • Incorrect rack position • Pans touching each other or oven walls
Food is dry or has shrunk excessively	<ul style="list-style-type: none"> • Oven temperature too high • Baking time too long • Oven door opened frequently • Pan size too large
Food is baking or roasting too slowly	<ul style="list-style-type: none"> • Oven temperature too low • Oven not preheated • Oven door opened frequently • Tightly sealed with aluminum foil • Pan size too small
Pie crusts do not brown on bottom or have soggy crust	<ul style="list-style-type: none"> • Baking time not long enough • Using shiny steel pans • Incorrect rack position • Oven temperature is too low
Cakes pale, flat and may not be done inside	<ul style="list-style-type: none"> • Oven temperature too low • Incorrect baking time • Cake tested too soon • Oven door opened too often • Pan size may be too large
Cakes high in middle with crack on top	<ul style="list-style-type: none"> • Baking temperature too high • Baking time too long • Pans touching each other or oven walls • Incorrect rack position • Pan size too small
Pie crust edges too brown	<ul style="list-style-type: none"> • Oven temperature too high • Edges of crust too thin

Solving Operational Problems

Before calling for service, check the following to avoid unnecessary service charges.

OVEN PROBLEM	PROBLEM SOLVING STEPS
The oven mode or temperature selected or the numbers selected do not appear in the display	The knob was turned too rapidly. Turn knob slower until correct wording or temperature appears. Review manual instructions when setting clock, timer, or Self-Clean.
F followed by 2 or 3 digits appear in the display window	Touch UPPER CANCEL or LOWER CANCEL or turn power off at the circuit breaker. Wait 5 minutes and turn it back on. If condition persists, note the code number and call an authorized servicer.
F121	This is caused by close contact to the control panel for more than 60 seconds, such as someone leaning against the controls or objects hanging in front of controls. See item above for correction.
Cooling fan continues to run after oven is turned off	The fan turns off automatically when the electronic components have cooled sufficiently.
Oven door is locked and will not release, even after cooling	Turn the oven off at the circuit breaker and wait 5 minutes. Turn breaker back on. The oven should reset itself and will be operable.
Oven is not heating	Check the circuit breaker or fuse box to your house. Make sure there is proper electrical power to the oven. Make sure the oven temperature has been selected.
Oven is not cooking evenly	Check oven calibration. Adjust calibration if necessary (see <i>Calibrating Oven Temperature</i> , Page 28). Refer to cook charts for recommended rack position. Always reduce recipe temperature by 25°F when baking with Convention Bake mode.
Oven temperature is too hot or too cold	The oven thermostat needs adjustment. See <i>Calibrating Oven Temperature</i> , Page 28.
Oven light is not working properly	Replace or reinsert the light bulb if loose or defective. See Page 37. Touching the bulb with fingers may cause the bulb to burn out.
Oven light stays on	Check for obstruction in oven door. Check to see if hinge is bent.
Cannot remove lens cover on light	There may be a soil build-up around the lens cover. Wipe lens cover area with a clean dry towel prior to attempting to remove the lens cover.
Oven will not Self-Clean properly	Allow the oven to cool before running Self-Clean. Always wipe out loose soils or heavy spill-over before running Self-Clean. If oven is badly soiled, set oven for a four-hour Self-Clean. See <i>Preparing the Oven to Self-Clean</i> , Page 31.
Clock and timer are not working properly	Make sure there is proper electrical power to the oven. See the Clock and Timer sections on Pages 12 and 13.
Excessive moisture	When using Bake mode, preheat the oven first. Convection Bake and Convection Roast will eliminate any moisture in oven (this is one of the advantages of convection).
Porcelain chips	When oven racks are removed and replaced, always tilt racks upward and do not force them to avoid chipping the porcelain.

HOW TO OBTAIN SERVICE

For authorized service or parts information call 800/ 735-4328.

We want you to remain a satisfied customer. If a problem does come up that cannot be resolved to your satisfaction write to Bosch Customer Support, 5551 McFadden Avenue, Huntington Beach CA, 92649 or phone 800/735-4328.

Please include the Model Number, Serial Number and date of original purchase and installation.

Model Warranty

Statement of Limited Warranty

The warranties provided by BSH Home Appliances (“Bosch”) in this Statement of Limited Warranty apply only to the Bosch Electric Built-In Ovens (“Built-In Oven”) sold to you, the first using purchaser, provided that the Built-In Oven was purchased (1) for your use and not for resale and (2) in the United States or Canada and is located in the country of purchase. As used in this Statement of Limited Warranty, the term “Date of Installation” shall refer to the earlier of the date the Built-In Oven is installed or ten (10) business days after the date the Built-In Oven is sold to the first using purchaser. The warranties stated herein apply only to the first using purchaser and are not transferable.

Standard Limited Warranty

Bosch warrants that its Built-In Oven is free from defects in materials and workmanship for a period of twelve (12) months from the Date of Installation. During the warranty period, Bosch or its authorized service center will repair or replace, at its sole option, any Built-In Oven that proves to have been defective under conditions of normal use without charge. All removed parts and components shall become the property of Bosch, at Bosch’s option. All replaced and/or repaired parts shall assume the identity of the original part for purposes of this warranty and this warranty shall not be extended with respect to such parts.

Other Conditions of the Limited Warranties

The warranties provided in this Statement of Limited Warranty exclude defects or damage resulting from (1) use of the Built-In Oven in other than its normal and customary manner (commercial use of the Built-In Oven shall not be deemed normal or customary), (2) misuse, abuse, accidents or neglect, (3) improper operation, maintenance, installation or unauthorized service, (4) adjustment or alteration or modification of any kind, (5) a failure to comply with applicable state, local, city, and county electrical and/or building codes, (6) spills of food or liquid, and (7) external forces such as floods, fires, acts of God or other circumstances beyond Bosch’s control. Also excluded from this warranty are scratches and damages on external surfaces and exposed parts or Built-In Ovens on which the serial numbers have been altered, defaced or removed.

To the extent allowed by law, this warranty sets out your exclusive remedies with respect to products covered by it, whether the claim arises in contract or tort (including strict liability, and negligence) or otherwise. Bosch will not be liable for consequential or incidental damages, losses, or expenses.

THIS WARRANTY IS IN LIEU OF ALL OTHER EXPRESS WARRANTIES. ANY WARRANTY IMPLIED BY LAW, WHETHER FOR MERCHANTABILITY OR FITNESS FOR A PARTICULAR PURPOSE OR OTHERWISE, SHALL BE EFFECTIVE ONLY FOR THE PERIOD THAT THIS EXPRESS WARRANTY IS EFFECTIVE.

No attempt to alter, modify or amend this warranty shall be effective unless authorized in writing by an officer of BSH.

How to Obtain Warranty Service

To obtain warranty service for the Built-In Oven, you should contact the nearest Bosch authorized service center.

BSH Home Appliances • 5551 McFadden Avenue, Huntington Beach, CA 92649 • 800/735-4328. See Page 39.

Service Data Record

The location of the serial tag on the product can be seen when the oven door is opened. It is located on the left side, centered vertically just inside the oven cavity. See Page 7. Now is a good time to write this information in the space provided below. Keep your invoice for warranty validation. To obtain service see Page 39.

Model number:
Serial Number:
Date of Installation or Occupancy:

Notes

BOSCH

5551 McFadden Avenue, Huntington Beach, CA 92649 • 800/735-4328
09BH0270 • © 2002 BSH Home Appliances Corp. • Litho Date: 1/02

Bosch is a registered trademark of the Robert Bosch Corporation. Genuine
European Convection is a trademark of BSH Home Appliances Corporation.
All other trademarks are property of their respective owners.

