

# 36" Gas Cooktop

500 Series – Stainless Steel NGM5658UC

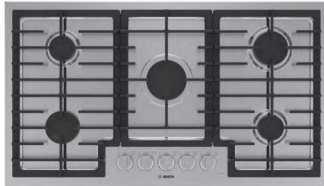

**NGM5658UC**  
Stainless Steel

**The 500® Series stainless steel gas cooktop with continuous cast iron grates and OptiSim® burner.**

## Features & Benefits

Five powerful high-efficiency gas burners allow you to cook multiple dishes with a full range of BTU performance.

Distinctive red LED light indicates if burners are on.

Continuous cast iron grates make it easier to slide pots from one burner to another without lifting.

Seamless, one-piece stainless steel design makes clean-up simple.

OptiSim® burner offers more flame control at the lowest settings for precise simmering and melting.

## General Properties

No. of burners	5
Knob color	Stainless Steel Appearance
Control location	Front-Center
Sealed burners	Yes
Valves	Gas
Ignition system	Electric; Thermocouple Flame Monitor Control
Cooktop surface material	Stainless Steel
Grate material	Cast Iron
Grate features	Continuous Grates

## Element Performance

Total BTU load (NG / LP)	41,700 / 41,700
Power of front left burner (NG / LP)	3,400 / 3,400
Power of back left burner (NG / LP)	6,000 / 6,000
Power of center burner (NG / LP)	16,000 / 16,000
Power of back right burner (NG / LP)	10,300 / 10,300
Power of front right burner (NG / LP)	6,000 / 6,000



## Technical Details

Circuit breaker	15 A
Volts	120 V
Frequency	60 Hz
Plug type	3-Prong
Power cord length	40"
Fuel type	Natural Gas (Factory Set)
Convertible to LP (kit required)	Yes

## Dimensions & Weight

Overall appliance dimensions (HxWxD)	3 3/4" x 37" x 21 1/4"
Required cutout size (HxWxD)	2" x 34 15/16" x 19 1/8"
Minimum distance from counter front	1 7/8"
Minimum distance from rear wall	3"
Net weight	41 lbs

## Accessories – Included

Included	LP Conversion Kit, OptiSim® Cap
----------	---------------------------------

## Accessories – Optional



**HEZ9GR58UC**  
Griddle



**HEZ298102**  
Wok Ring

\*To be fully ADA compliant, these units must be installed according to ADA guidelines. Please check current ADA requirements for guidance on installation.

**Accessories:** To purchase Bosch accessories, cleaners & parts please visit [www.bosch-home.com/us/store](http://www.bosch-home.com/us/store) or call 1-800-944-2904 (Mon to Fri 5 am to 6 pm PST, Sat 6 am to 3 pm PST).

**Notes:** All height, width and depth dimensions are shown in inches. BSH reserves the absolute and unrestricted right to change product materials and specifications, at any time, without notice. Consult the product's installation instructions for final dimensional data and other details prior to making cutout.

**Warranties:** Please see Use & Care manual or Bosch website for statement of limited warranty.

**For more information on our entire line of products, go to [www.bosch-home.com/us](http://www.bosch-home.com/us) or call 1-800-944-2904**

© BSH Home Appliances Corporation. All rights reserved. Bosch is a registered trademark of Robert Bosch GmbH.

# 36" Gas Cooktop

500 Series – Stainless Steel NGM5658UC

## Installation Details

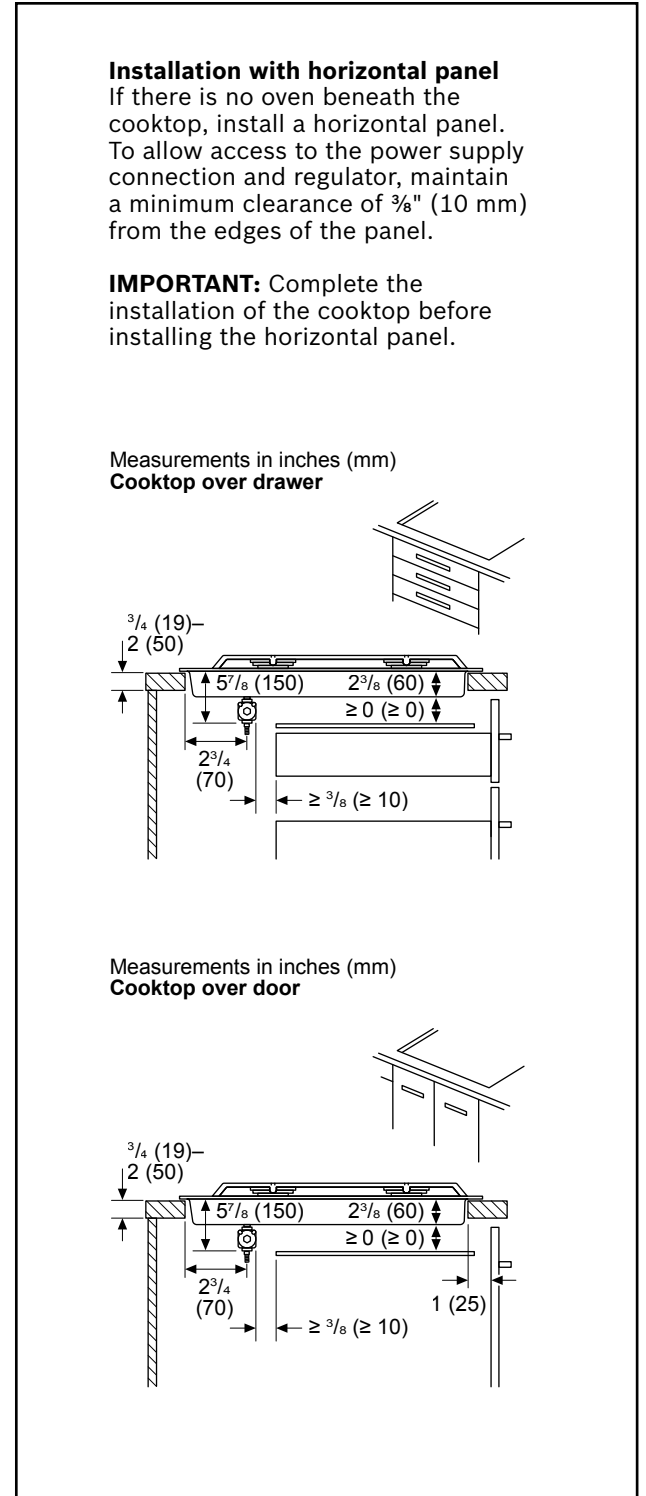
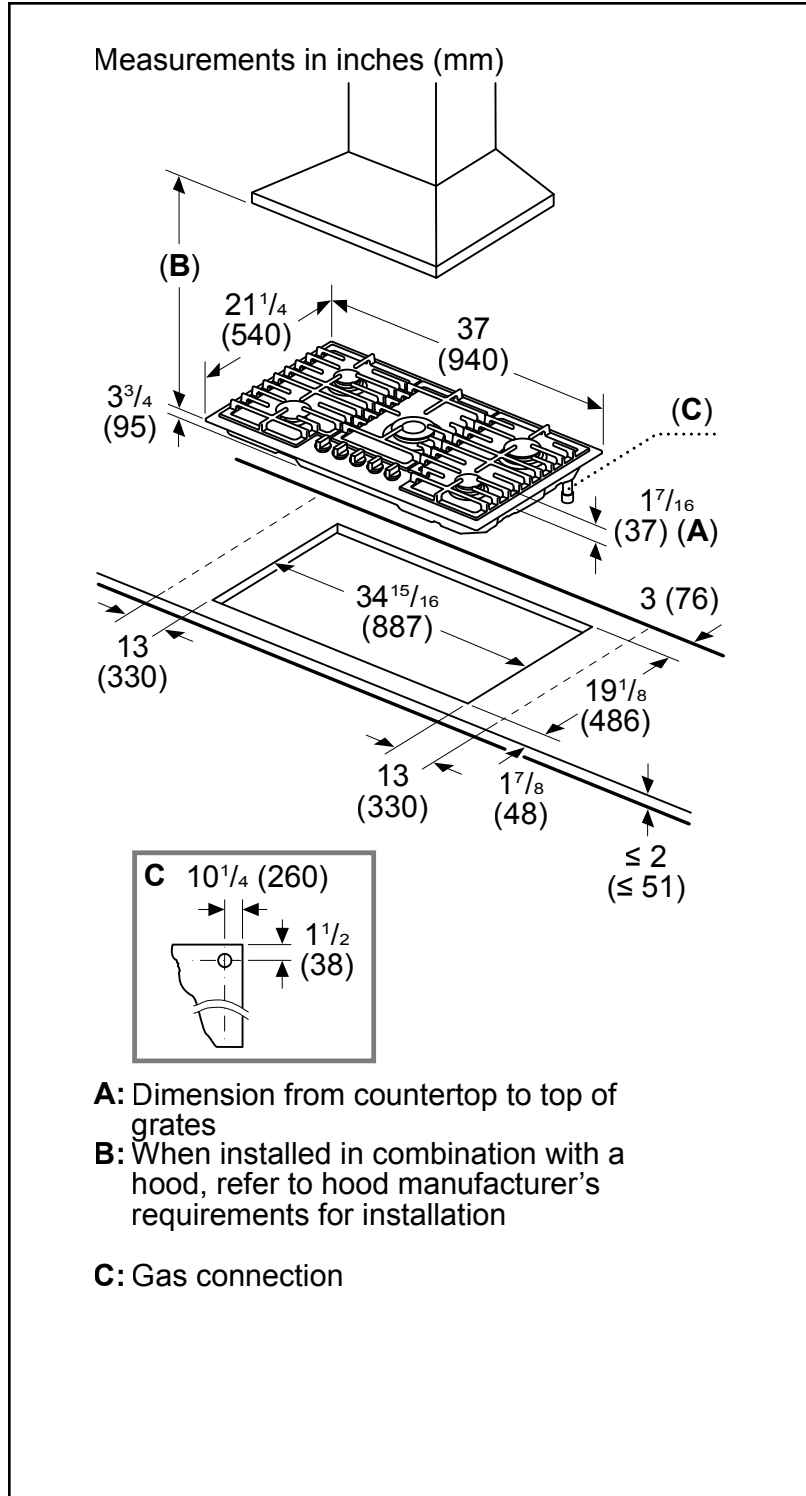

**Accessories:** To purchase Bosch accessories, cleaners & parts please visit [www.bosch-home.com/us/store](http://www.bosch-home.com/us/store) or call 1-800-944-2904 (Mon to Fri 5 am to 6 pm PST, Sat 6 am to 3 pm PST).

**Notes:** All height, width and depth dimensions are shown in inches. BSH reserves the absolute and unrestricted right to change product materials and specifications, at any time, without notice. Consult the product's installation instructions for final dimensional data and other details prior to making cutout.

**Warranties:** Please see Use & Care manual or Bosch website for statement of limited warranty.

**For more information on our entire line of products, go to [www.bosch-home.com/us](http://www.bosch-home.com/us) or call 1-800-944-2904**

© BSH Home Appliances Corporation. All rights reserved. Bosch is a registered trademark of Robert Bosch GmbH.

# 36" Gas Cooktop

500 Series – Stainless Steel NGM5658UC



**BOSCH**

Invented for life



## Installation Details

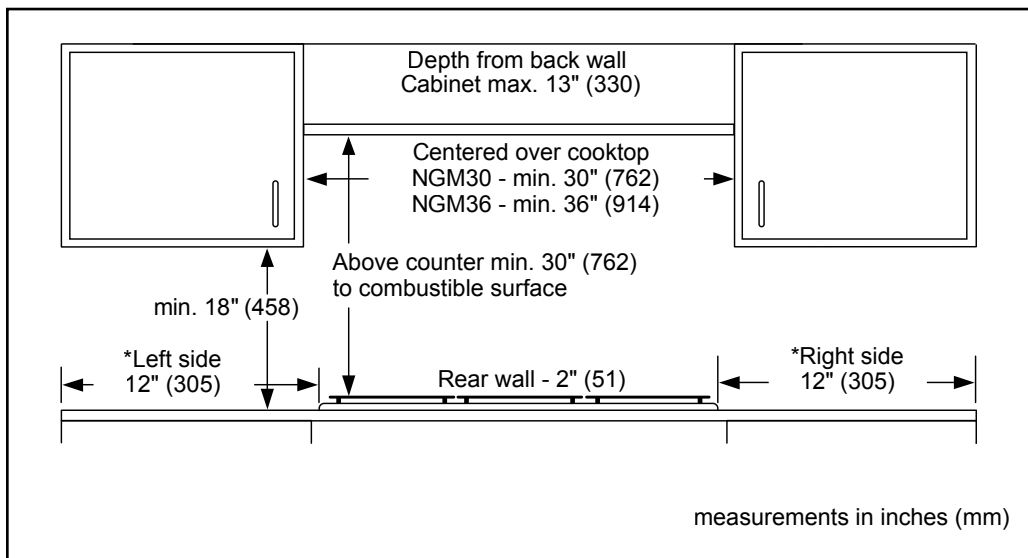
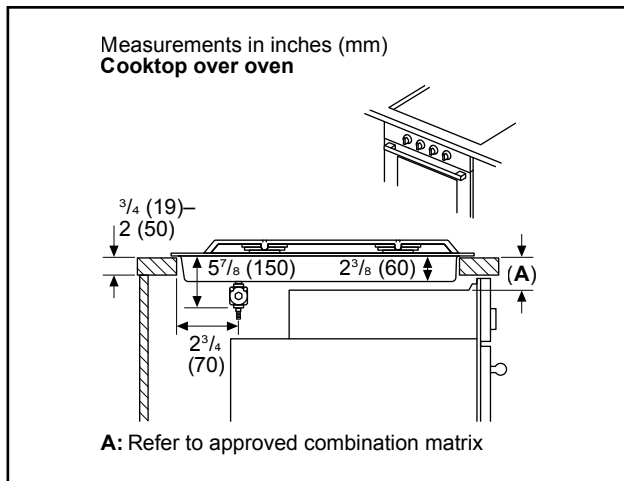

**Accessories:** To purchase Bosch accessories, cleaners & parts please visit [www.bosch-home.com/us/store](http://www.bosch-home.com/us/store) or call 1-800-944-2904 (Mon to Fri 5 am to 6 pm PST, Sat 6 am to 3 pm PST).

**Notes:** All height, width and depth dimensions are shown in inches. BSH reserves the absolute and unrestricted right to change product materials and specifications, at any time, without notice. Consult the product's installation instructions for final dimensional data and other details prior to making cutout.

**Warranties:** Please see Use & Care manual or Bosch website for statement of limited warranty.

**For more information on our entire line of products, go to [www.bosch-home.com/us](http://www.bosch-home.com/us) or call 1-800-944-2904**

© BSH Home Appliances Corporation. All rights reserved. Bosch is a registered trademark of Robert Bosch GmbH.