

Features and Benefits

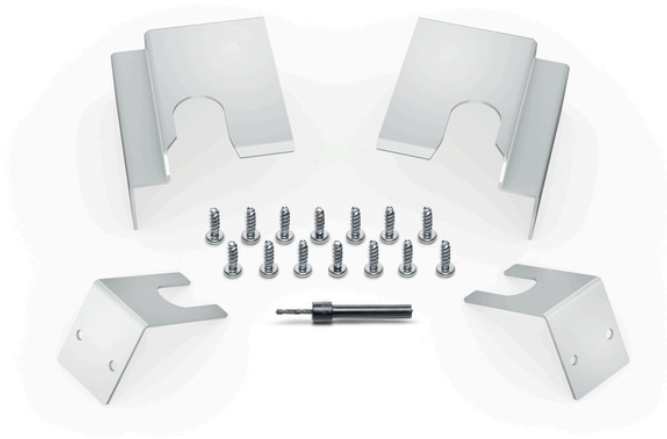

Notes: All height, width and depth dimensions are shown in inches. *Please refer to installation instructions prior to making cutout. BSH reserves the absolute and unrestricted right to change product materials and specifications, at any time, without notice. Consult the product's installation instructions for final dimensional data and other details. Applicable product warranty can be found in a accompanying product literature or you may contact your account manager for further details.

For more information on our entire line of products, go to boschappliances.com or call 1-800-944-2904.
Copyright ©2022 BSH Home Appliances Corporation. All rights reserved. Bosch is a registered trademark of Robert Bosch GmbH.

Litho Date: 05/2022

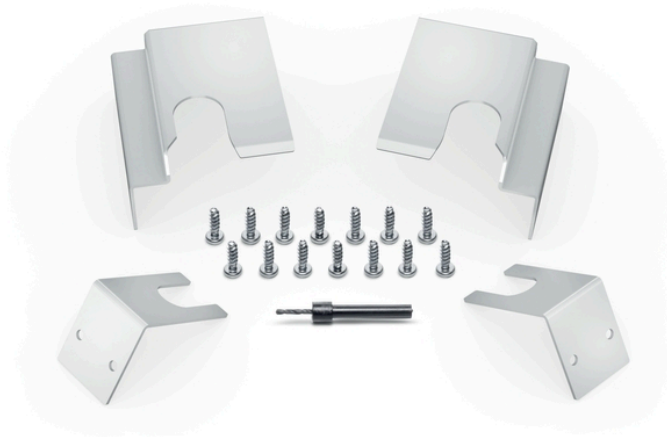

Features

Product Description	
Brand	Accessory Bosch
Product name / series name	
SKU	WTZSB30UC
Internal article number	WTZSB30UC
EAN code	4242005310302
Product packaging dimensions (HxWxD)	
	11
	13
Quantity per packing unit	
Standard number of units per pallet	20
UPC code	825225965732
Product image	18116185_WTZSB30UC_STP_def.jpg

Technical Specification

Notes: All height, width and depth dimensions are shown in inches. *Please refer to installation instructions prior to making cutout. BSH reserves the absolute and unrestricted right to change product materials and specifications, at any time, without notice. Consult the product's installation instructions for final dimensional data and other details. Applicable product warranty can be found in a accompanying product literature or you may contact your account manager for further details.

For more information on our entire line of products, go to boschappliances.com or call 1-800-944-2904.
Copyright ©2022 BSH Home Appliances Corporation. All rights reserved. Bosch is a registered trademark of Robert Bosch GmbH.

Litho Date: 05/2022