

BOSCH

YOUR LIFE. OUR INSPIRATION.

DISHWASHER USE AND CARE MANUAL

MODEL: SGV45E03UC

GUIDE D'ENTRETIEN ET D'UTILISATION DU LAVE-VAISSELLE

MODÈLE: SGV45E03UC

MANUAL DE USO Y CUIDADO PARA LAVADORA DE PLATOS

MODÉLOS: SGV45E03UC



Congratulations, and Thank You from Bosch!

Thank you for selecting a Bosch dishwasher. You have joined the many consumers who demand quiet and superior performance from their dishwashers.

This manual was written with your safety and convenience in mind, and the information contained herein is very important. We highly recommend that you read this manual before you use your dishwasher for the first time.

To learn even more about your dishwasher and available accessories, as well as many other top-quality Bosch appliances, visit our website at www.boschappliances.com.

Please contact us if you have any questions or comments. Call **1-800-944-2904**, or write to:

BSH Home Appliances, Corp.
5551 McFadden Avenue
Huntington Beach, CA 92649

Enjoy!

| | |
|--|-------|
| IMPORTANT SAFETY INSTRUCTIONS | 4-5 |
| Dishwasher Components..... | 5 |
| Dishwasher Features and Options..... | 6 |
| Dishware Materials..... | 7 |
| Preparing and Loading the Dishware | 7-9 |
| Dishware Preparation | 7 |
| Loading the Dishwasher | 7-9 |
| Adding Detergent and Rinse Agent | 10-11 |
| Operating the Dishwasher | 11-13 |
| Dishware Drying | 13 |
| Unloading the Dishwasher | 13 |
| Care and Maintenance | 13-15 |
| Wash Cycle Information/Sanitized..... | 16-17 |
| Self Help | 18 |
| Statement of Warranties..... | 19 |
| Customer Service | 20 |

Important Safety Instructions - Save This Information

WARNING

Misuse of the dishwasher can result in serious injury or death. Do not use the dishwasher in any way not covered in this manual or for any purpose other than those explained on the following pages.

WARNING

Severe product damage and/or injury could result from the use of unqualified service technicians or non-original replacement parts. All repairs must be performed by a qualified service technician using only original equipment factory replacement parts.

WARNING

Electrical shock or fire could result if the electrical supply for the dishwasher covered in this manual is incorrectly installed or if the dishwasher has been improperly grounded. Do not use the dishwasher covered in this manual if you are not certain the electrical supply has been correctly installed or the dishwasher has been properly grounded.

ATTENTION

Never use steam cleaning products to clean your dishwasher. The manufacturer will not be liable for possible damages or consequences.

ATTENTION

Never use harsh chemicals to clean your dishwasher. Some chloride-containing cleaning products can damage your dishwasher and may present health hazards!

ATTENTION

It is highly recommended for the end use consumer to become familiar with the procedure to shut off the incoming water supply and the procedure to shut off the incoming power supply. See the Installation Instructions or speak with your installer for more information.

⚠ Important Safety Instructions - Save This Information ⚠

- This appliance must be grounded to a metal, permanent wiring system, or an equipment grounding conductor must be run with the circuit conductors and connected to the equipment grounding terminal or lead on the dishwasher. See the **Installation Instructions** included with this dishwasher for more information on electrical requirements.
- Use this dishwasher only for its intended function, which is the washing of household dishware and kitchenware.
- This dishwasher is provided with **Installation Instructions** and this **Use and Care Manual**. Read and understand all instructions before using the dishwasher.
- Use only detergents or rinsing agents recommended for use in a dishwasher, and keep them out of the reach of children.
- When loading items to be washed:
 - Locate sharp items so that they are not likely to damage the door seal.
 - Load knives and other sharp utensils with their HANDLES UP to reduce the risk of cut-type injuries.
- Do not wash plastic items unless they are marked "dishwasher safe" or the equivalent. For plastic items not so marked, check the manufacturer's recommendations.
- Do not operate your dishwasher unless all enclosure panels are in place.
- Do not tamper with or override controls and interlocks.
- Do not abuse, sit on, or stand on the door or dish racks of the dishwasher.
- To reduce the risk of injury, do not allow children to play in or on the dishwasher.
- When children become old enough to operate the appliance, it is the legal responsibility of the parents or legal guardians to ensure that they are instructed in safe practices by qualified persons.
- Under certain conditions, hydrogen gas may be produced in a hot water system that has not been used for two weeks or more. Hydrogen gas is explosive. Before using a dishwasher that is connected to a hot water system that has been unused for two weeks or longer, turn on all hot water faucets and let the water flow from each for several minutes. This will release any accumulated hydrogen gas. As the gas is explosive, do not smoke or use an open flame during this time.
- Remove the door to the washing compartment when removing an old dishwasher from service or discarding.
- To avoid floor damage and possible mold growth, do not allow wet areas to remain around or under the dishwasher.
- Protect your dishwasher from the elements. Protect against freezing to avoid possible damage to the fill valve. Damage caused by freezing is not covered by the warranty.

Dishwasher Components

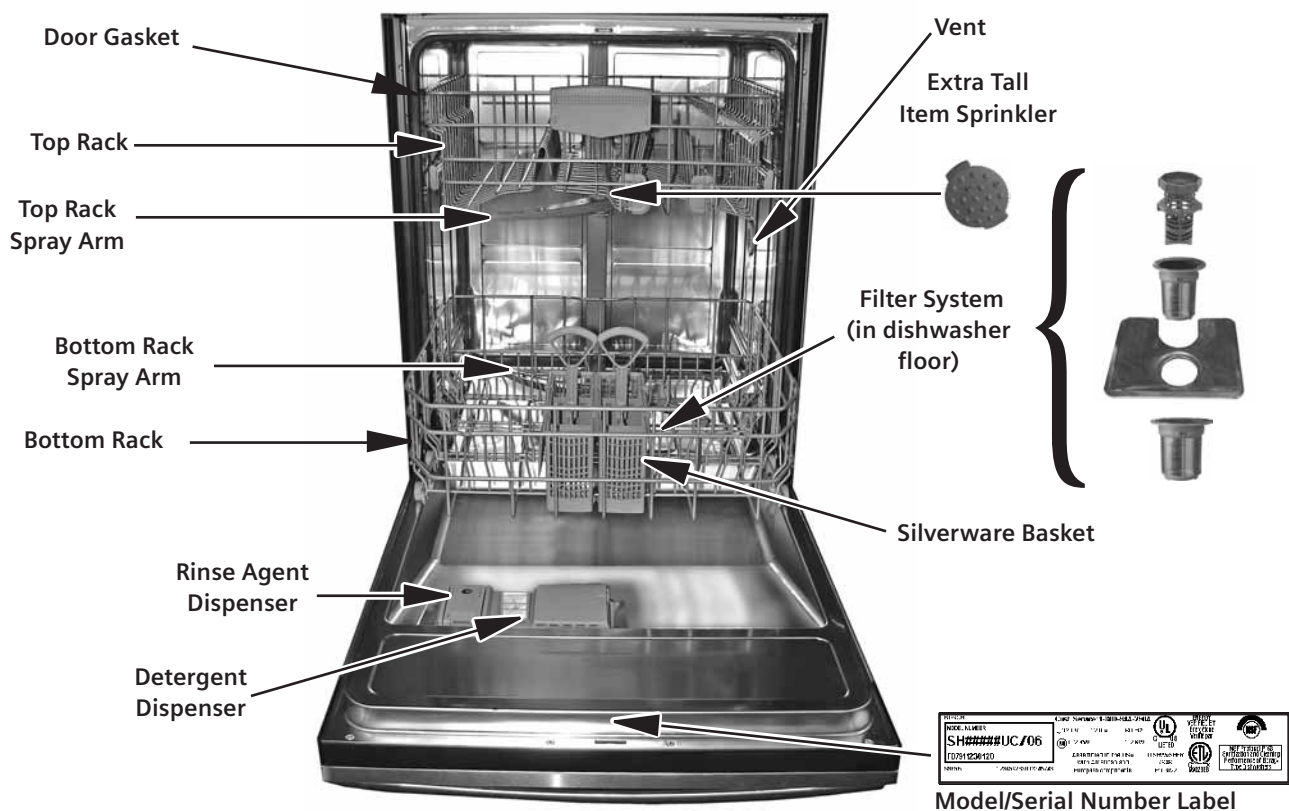

Dishwasher Features and Options

Noise Reduction System

A two-pump motor system, the Suspension Motor™, and triple insulation make this dishwasher one of the quietest in North America.

Stainless Steel TALLTUB™

A rust-free, hygienic interior surface with a lifetime warranty.

Nylon Coated Racks

Eliminate cuts and nicks, and have a five-year warranty.

Flow-Through Heater™

Heats water to a temperature of up to 161°F.

OPTIDRY™

Senses when the unit is low on rinse agent and automatically increases drying time.

Extra Dry Heat

With this option you can raise the temperature of the rinse water and increase the drying time which will result in improved drying.

Condensation Drying:

A high temperature final rinse, a low temperature stainless steel tub, and the sheeting action of a rinse agent result in drying that is hygienic, energy efficient, and economical.

SENSOTRONIC™ Water Condition Monitor:

Checks water condition and decides whether a second fresh water fill is necessary.

Filter System

Three filters ensure distribution of clean water and protect the main pump and the drain pump from foreign material.

Water Shut-Off

A safety feature that stops the flow of incoming water, if water is detected in the base of the dishwasher.

Info light

The dishwasher is so quiet, you might not even know it is running. That is why we designed a light that beams onto the floor while it is running to let you know the machine is in use.

Delay Start

The dishwasher works on your schedule, running after you've drifted off to sleep or even while you are out of the house.

Upper and Lower Rack Flip Tines

These allow for customized layout to accommodate large or oddly shaped items.

Flexible Silverware Basket

Can be placed anywhere for effective use of space.

SGV45 FEATURES

| Control Panel Design | Audible Cycle Completion Signal | Count-down Display | Refill Rinse Agent Light | Sanitized Indicator Light | Delay Start | Upper Rack Flip Tines | Lower Rack Flip Tines | Silverware Basket | Extra Dry Heat | OPTIDRY | Info Light | Power Boost |
|----------------------|---------------------------------|--------------------|--------------------------|---|-------------|-----------------------|-----------------------|-------------------|----------------|---------|------------|-------------|
| Hidden Top Control | Yes | Yes | Yes |  | 19H | Yes | Yes | Flexible | Yes | Yes | Yes | Yes |

Dishware Materials

NOTE: Before using your dishwasher for the first time, check the information in this section. Some items are not dishwasher safe and should be hand-washed; others require special loading. Contact the item's manufacturer if you are unsure about the item's dishwasher suitability.

Recommended

Aluminum: Colored anodized aluminum may fade over time. Minerals in your water may cause the aluminum to darken or spot. This can usually be removed by using a soap-filled steel wool pad.

China, Crystal, Stoneware: Some hand-painted pieces may discolor, fade, or spot. Hand-wash these pieces. Position fragile glassware so that it will not topple over or contact other pieces during the wash cycle.

Glass: Milk glass may yellow.

Non-Stick Coatings: Apply a light coating of vegetable oil to non-stick surfaces after drying.

Plastics: Make sure the piece is dishwasher safe.

Stainless Steel, Sterling Silver, and Silver Plate: Place these pieces so that they do not contact dissimilar metals.

Not Recommended

Acrylic: crazing (small cracks throughout the acrylic) may occur.

Adhesive-Joined Pieces: Adhesives that join materials such as plastic, wood, bone, steel copper, tin, etc. may loosen.

Bone-Handled Utensils: Handles may separate.

Iron: Iron will rust. Hand-wash and dry immediately.

Non-Dishware Items: Your dishwasher is intended for use in cleaning ONLY standard household dishware and kitchenware.

Pewter, Brass, Bronze: Pewter will tarnish. Hand-wash and dry immediately.

Tin: Tin will rust. Hand-wash and dry immediately.

Wood: Wooden bowls, wooden utensils, and wood-handled utensils can crack, warp, and lose their finish.

Preparing and Loading the Dishware

Dishware Preparation

Do not pre-wash items having loosely-attached soiling. Remove large food particles, bones, seeds, toothpicks, and excessive grease. Items having burned-on, baked-on or starchy soils may require pre-treatment.

Loading the Dishwasher

Check the Materials section of this manual if you are unsure about an item's dishwasher suitability.

Load only dishwasher-safe items into the dishwasher. Load dishes in the dishwasher racks so that the insides of bowls, pots, and pans are facing the spray arms. Avoid nesting and contact points between dishes. Separate items of dissimilar metals.

Loading the Top Rack

Figures 1 and 2 show typical 10 and 12 place load patterns for the top rack.

NOTE: Make sure items do not protrude through the bottom of the racks and block the spray arms.

ATTENTION

To avoid dishwasher damage, do not load the dishwasher with objects such as paper products, plastic bags, packing materials, or anything other than normal dishware and kitchenware. Do not load the dishwasher with anything other than dishwasher-safe dishware and kitchenware.

Figure 1
10 place setting top rack

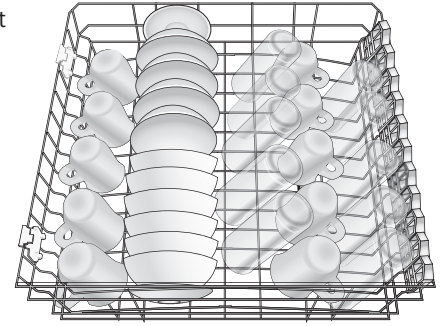

Figure 2
12 place setting top rack

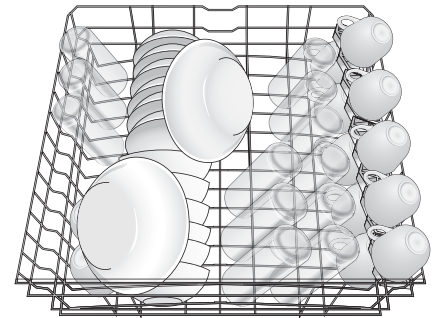

Figure 3

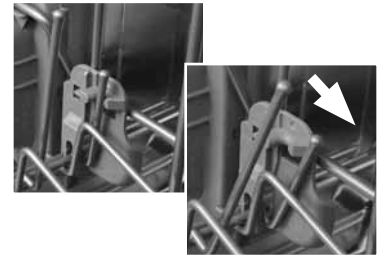

Figure 4

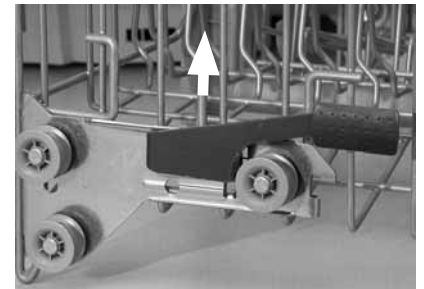

Figure 5

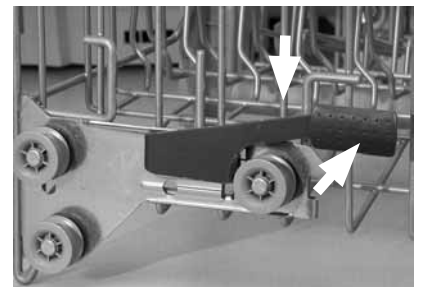

Figure 6

10 place setting bottom rack

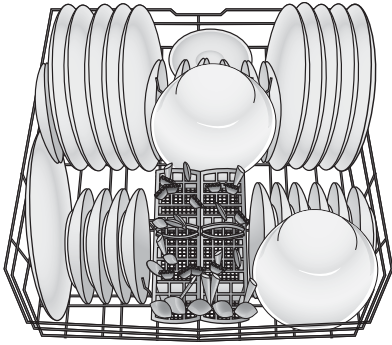

Figure 7

12 place setting bottom rack

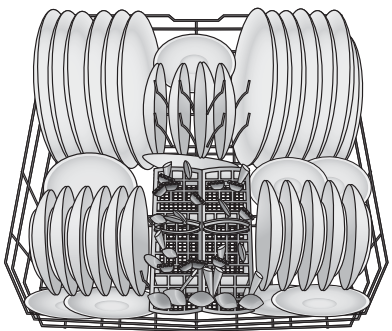

Figure 8

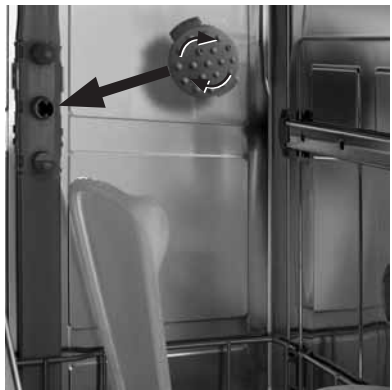

Figure 9

Do not block vent.



Top Rack Accessories

Top Rack Flip Tines

Flip Tines fold down to make loading the racks easier in some instances. Grasp the tines, release from notch, and fold the tines downward. When the top rack is loaded, push it into the dishwasher.

NOTE: When pushing the top rack into the dishwasher, push it until it stops against the back of the tub so the top rack spray arm will connect to the water supply. Do not push the top rack with the door.

Top Rack Height Adjustment

The top rack can be lowered to accommodate large items in the top rack, and raised to make room for large items in the bottom rack.

To raise the top rack:

1. Pull the top rack out of the dishwasher until it stops rolling.
2. Grasp the top of the rack above the Automatic Height-Adjustable Top Rack handles and pull it upward as shown in Figure 4 until the Automatic Height-Adjustable Top Rack handles lock the rack into position (you do not need to press the Automatic Height-Adjustable Top Rack handles in order to raise the rack).

NOTE: Before you push the top rack back into the dishwasher, ensure that the rack height is the same on both sides. Otherwise, the dishwasher door will not shut and the top rack spray arm will not connect to the water circuit.

To lower the top rack:

1. Pull the top rack out of the dishwasher until it stops rolling.
2. Press the Automatic Height-Adjustable Top Rack handles inward as shown in Figure 5 and let the rack drop.

Loading the Bottom Rack

Place large items in the bottom rack. Load pots, pans and bowls upside-down. Figures 6 and 7 show typical mixed loads for the bottom rack.

Loading Extra Tall Items

If an item is too tall to be placed into the bottom rack even with the top rack in the raised position, remove the empty top rack by pulling it out of the dishwasher until it stops rolling. Pull the front of the rack upward and outward until the rollers are completely free of the roller guides. Set the top rack aside. Push the roller guides back into the dishwasher. Insert the Extra Tall Item Sprinkler into the top rack spray outlet and turn the sprinkler clockwise to lock it into position as shown in Figure 8. Place your extra tall item(s) in the bottom rack as shown in Figure 9.

NOTE: Keep the vent on the tub's right side clear by placing tall items such as plastic cutting boards and tall baking sheets on the bottom rack's left side, center, or back.

ATTENTION

To avoid dishwasher damage, do not reinstall the top rack without removing the extra tall item sprinkler. Do not reinstall the top rack with the sprinkler installed.

To remove the sprinkler and return the dishwasher to its normal condition:

1. Turn the sprinkler counterclockwise and remove it.
2. Retrieve the top rack.
3. Tilt the top rack upwards and position the top rack rollers onto the roller guides.
4. Continue pushing the top rack until the rollers are on the guide.
5. Push the top rack into the dishwasher.

Loading the Silverware Basket

NOTE: The silverware basket tops can be folded up to accommodate large or oddly-shaped items.

With the silverware basket tops down, load the silverware basket following the patterns suggested in Figures 10 and 11). Place knives with their handles up, and forks and spoons with their handles down.

If large or oddly-shaped items are to be loaded into the silverware basket with the tops up, load the items so that they do not nest together. Load knives and sharp utensils with their handles up.

⚠ CAUTION

The sharp points and edges of knives and other sharp utensils can cause serious injuries. Load knives and other sharp utensils with sharp points and edges down. Do not allow children to handle or play near knives and sharp utensils.

The Flexible Silverware Basket

This basket is designed for maximum versatility. The basket splits along its length, resulting in two halves that may be placed in a variety of positions in the lower rack, greatly increasing the lower rack's loading versatility.

To split the Flexible Silverware Basket:

1. Grasp the basket as shown in Figure 12A, and slide the two halves in opposite directions, as shown in Figure 12A.
2. Pull the two halves apart, as shown in Figure 12B.

Some suggestions for placing the two halves in the lower rack are shown in Figure 13.

Figure 10

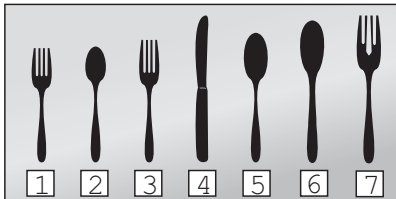
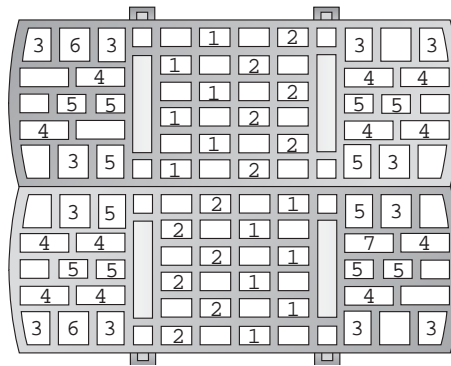

Figure 11



12 place setting

Figure 12

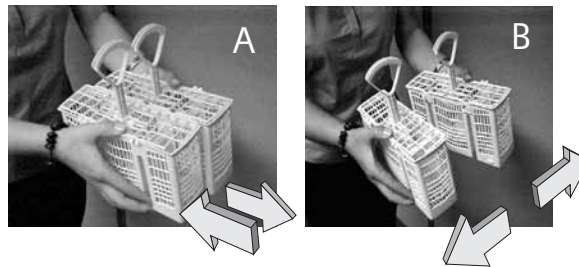

Figure 13

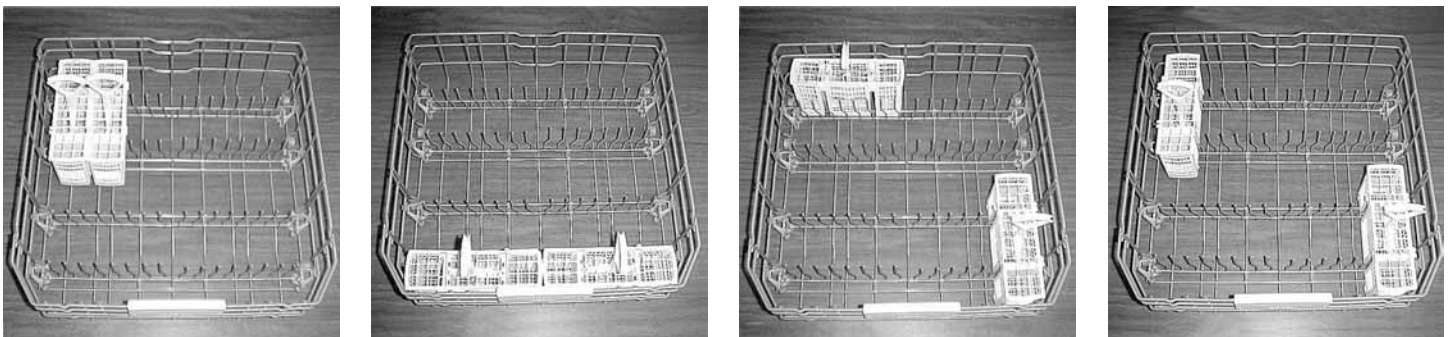
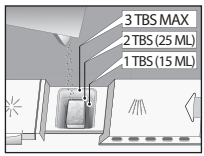

Figure 14



Add Detergent

- Use fresh powdered detergent for best results
- 1 tablespoon will clean most loads
- 3 tablespoons Max, do not overfill
- When using detergent tabs, lay them flat to avoid contact with the cover

Adding Detergent and Rinse Agent

Detergent

Use only detergent specifically designed for dishwashers. For best results, use fresh powdered dishwashing detergent.

ATTENTION

To avoid dishwasher damage, do not use hand dishwashing products in your dishwasher.

This dishwasher uses less water so you need to use less detergent. With soft water, 1 tablespoon (15ml) of detergent will clean most loads. The detergent dispenser cup has lines that measure detergent to 1 tablespoon (15ml) and 1.75 tablespoons (25ml). 3 tablespoons (45ml) of detergent will completely fill the detergent dispenser cup.

ATTENTION

To avoid dishware damage, do not use too much detergent if your water supply is soft. Using too much detergent in soft water may cause etching in glassware.

NOTE: If you do not know the hardness of your water supply, use 15ml of detergent. Increase the amount of detergent, if necessary, to the least amount required to get your dishware and kitchenware clean.

Use the measuring lines in the detergent dispenser cup as a guide to measure the amount of detergent recommended in Table 1.

Figure 15

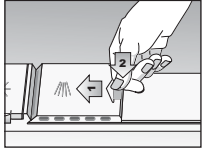

To close

- 1 Slide cover fully left
- 2 Push rear of cover down firmly until you hear the **CLICK**

Figure 16

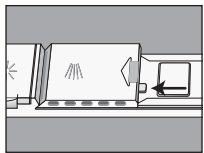

To open the cover

- Push the blue button in (NOT DOWN)

Figure 17

Always use Rinse Agent even if your detergent contains Rinse Agent

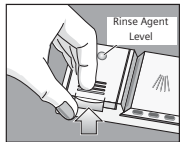

Lift tab to open

- Add Rinse Agent when the light on the control panel illuminates or (Model Dependent)
- Rinse Agent Level indicator on the dispenser changes to a light silver color

| Table 1 - Recommended Detergent Amount | | | | |
|--|------|------------|-----------|-----------|
| Wash Cycle | Unit | Water Type | | |
| | | Hard | Medium | Soft |
| Pots & Pans | ml | 45 | 45 | 25-45 |
| | Tbsp | 3 | 3 | 1.75 to 3 |
| Regular Wash | ml | 25-45 | 25 | 15-25 |
| | Tbsp | 1.75 to 3 | 1.75 | 1 to 1.75 |
| Delicate / Econo | ml | 25 | 15-25 | 15 |
| | Tbsp | 1.75 | 1 to 1.75 | 1 |
| Quick Wash | ml | 25 | 15-25 | 15 |
| | Tbsp | 1.75 | 1 to 1.75 | 1 |

Figure 18



- To add Rinse Agent pour on the arrow
- Turn arrow to adjust the amount of rinse agent dispensed

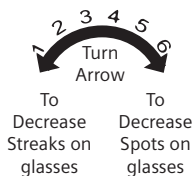

Filling the Detergent Dispenser

Fill the dispenser cup as recommend in Table 1. (See Figure 14 for additional information.)

To close, slide the detergent dispenser cover in the direction shown in Figure 15 and press it down firmly so the cover snaps shut.

To open the detergent dispenser cover, press the blue release tab in the direction shown in Figure 16. Pressing down on the release tab will not open the cover.

Rinse Agents

To achieve proper drying, always use a liquid rinse agent, even if your detergent contains a rinse agent or drying additive.

Rinse Agent Dispenser

Open the rinse agent dispenser by lifting the tab with your thumb as shown in Figure 17.

NOTE: The dishwasher indicates low rinse agent by showing the symbol  in the countdown display.

Add liquid rinse agent to the dispenser as shown in Figure 18 until the rinse agent reservoir is full. Wipe up any excess rinse agent that puddles when the dispenser reservoir is full.

NOTE: After filling the rinse agent dispenser, the indicator light will go out in a few minutes after the dishwasher door is shut (select models only).

Operating the Dishwasher

Always make sure your dishware is dishwasher safe. Refer to the **Dishware Materials** section of this manual for guidance.

Wash Cycles

Pots and Pans

Cleans items having baked-on or hard dried-on food soils. These items may require soaking or hand scouring.

Regular

Thoroughly cleans large loads having loosely attached normal soiling.

Delicate/Econo

For delicate or heirloom dishwasher and silverware or other special items. Always make sure that the items are dishwasher safe. Refer to the Materials section of this manual for further information. Hand washing may be the best treatment of such items.

Quick

For lightly soiled items with easy to remove food soils.

Wash Cycle Options

Power Boost

Accelerates the time of the wash cycle to about 60 minutes. Select your wash cycle (pots and pans, regular or delicate/econo only), then select the Powerboost button.

Delay Start

This option allows you to delay the start time of your dishwasher.

To activate:

- Turn the dishwasher on.
- Select the desired wash cycle.
- Press and hold the Delay Start button. Release when the desired delay time is shown in the display window.

Extra Dry Heat

With this option you can raise the temperature of the rinse water and increase the drying time which will result in improved drying.

To activate:

- Press and hold the left "Cancel Drain" button, then press and hold the On/Off button.
- When the LED display shows a "00" or a "01" release both buttons.
- To enable the Additional Drying Heat, press the left "Cancel Drain" button until the LED display shows a "01".
- To disable the Additional Drying Heat, press the left "Cancel Drain" button until the LED display shows a "00".
- Press the On/Off button to save the setting.

The Cycle Completion Signal

This Cycle Completion Signal is a tone that sounds to alert you when your dishwasher finishes washing and drying your dishes. You can either disable the tone or set the volume.

To activate:

- Press and hold the right “Cancel Drain” button then press and hold the On/Off button.
- When the light on the “Cancel Drain” button you are pressing illuminates and the tone begins to sound, release both buttons.
- Press the right-most “Cancel Drain” button until the tone is either at the desired volume or is silent.
- Press the On/Off Button. The Cycle Completion Signal is now set.

Starting the Dishwasher

To start the dishwasher, follow the instructions in Figure 19.

Interrupting a Cycle

NOTE: Should you need to interrupt a cycle (to add or remove an item, to add detergent, etc.), it is best to do so within the first 30 minutes of the cycle.

Hidden Top Controls (See Figure 19)

1. Open the dishwasher door just far enough to expose the control panel.
2. Press the On/Off button to turn the unit off.
3. Wait at least ten seconds or until the water noises stop before opening the dishwasher door.
4. To resume the cycle, press the On/Off button and close the dishwasher door.

WARNING

You could be seriously scalded if you allow hot water to splash out of the dishwasher. **OPEN THE DOOR CAREFULLY** during any wash or rinse cycle. Do not fully open the door until water noises have stopped.

Wait at least ten seconds or until water noises stop before opening the dishwasher door. To resume the cycle, press the On/Off button and shut the dishwasher door.

Canceling or Changing a Cycle

To cancel or change a cycle, open the dishwasher door far enough to expose the control buttons then press and hold for three seconds the two buttons labeled “Cancel Drain” as shown in Figure 20.

Close the door and wait until the dishwasher completes the cycle (approximately 1 minute). Open the door and press the ON/OFF button.

You may now begin a new cycle.

Dishware Drying

At the end of the cycle the dishwasher will stop and a period of condensation drying will follow. After drying, the cycle is complete and:

- the completion signal will sound.
- the InfoLight will turn off.
- the countdown display will show “0”.

NOTE: If your household water supply is too hot, your dishwasher’s heating time may be reduced and the “Sanitized” light may not illuminate. Your Dishwasher Installation Manual has information on the recommended temperature for your household hot water supply.

NOTE: To accelerate and enhance drying, open the dishwasher door, pull the top rack a few inches out of the dishwasher, and prop the dishwasher door against the top rack.

Unloading the Dishwasher

Unload the bottom rack first.

Figure 19

Hidden Top Controls

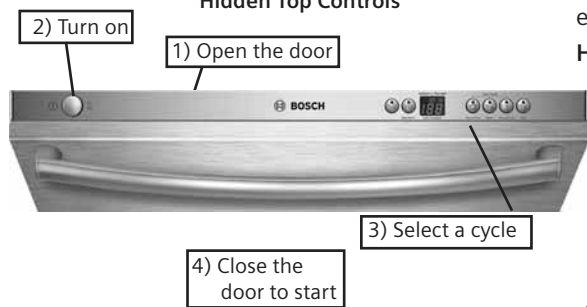
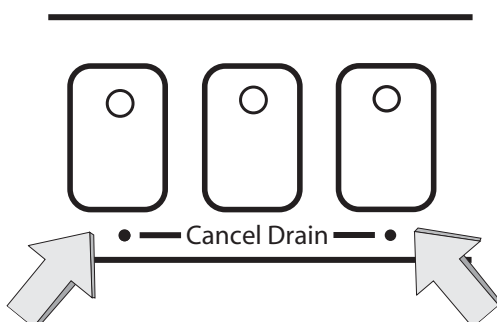

Figure 20



Unload the silverware basket(s). They are easily removed for unloading.

Unload the top rack.

If the Extra Tall Item Sprinkler was installed, return the dishwasher to its normal condition (see the Loading Extra Tall Items instructions in the "Loading the Dishwasher" section of this manual).

Care and Maintenance

Maintenance Tasks

Certain areas of your dishwasher require occasional maintenance. The maintenance tasks are easy to do and will ensure continued superior performance from your dishwasher.

These tasks are:

- Winterizing Your Dishwasher
- Wiping up Spills and Splash-out
- Clean the Stainless Steel Inner Door and Tub
- Check/Clean the Spray Arm Nozzles
- Check/Clean the Filter System
- Clean the Exterior Door Panel
- Clean the Door Gasket

Winterizing Your Dishwasher

If your dishwasher will be unused for an extended period of time in a location that experiences freezing temperatures (e.g., in a holiday home or through a vacation period), have your dishwasher winterized by an authorized service center.

ATTENTION

To avoid dishwasher damage, do not allow water to remain in your dishwasher systems through extended periods of freezing temperatures. Freezing temperatures can damage your dishwasher.

Wiping Up Spills and Splash-out

Water may occasionally splash out of your dishwasher, especially if you interrupt a cycle or open the dishwasher door during a cycle. To avoid floor damage and possible mold growth, do not allow wet areas to remain around or under the dishwasher.

Check/Clean the Stainless Steel Inner Door and Tub

Clean the outer edges of the inside door panel regularly to remove debris that might collect there from normal loading.

If spots begin to appear on the stainless steel tub or inner door, make sure the rinse agent reservoir is full.

Check/Clean the Spray Arm Nozzles

Occasionally check the spray arms to ensure that the spray arm nozzles (holes) are unobstructed. You must remove the spray arms to check them for obstruction.

Figure 21

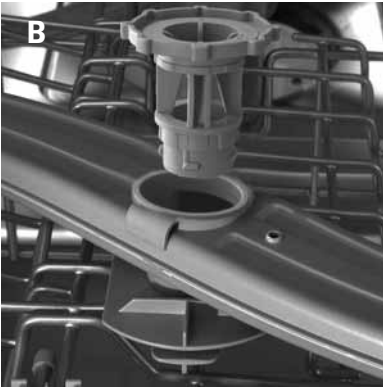
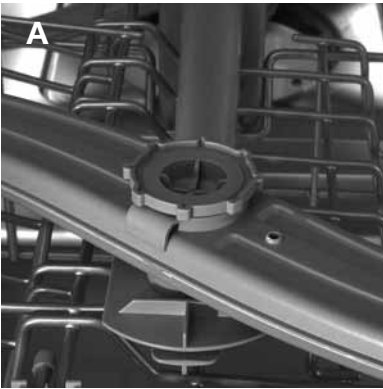

Figure 22

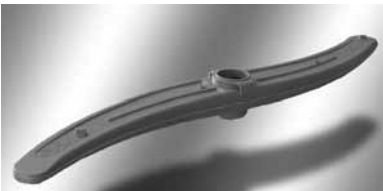

Figure 23

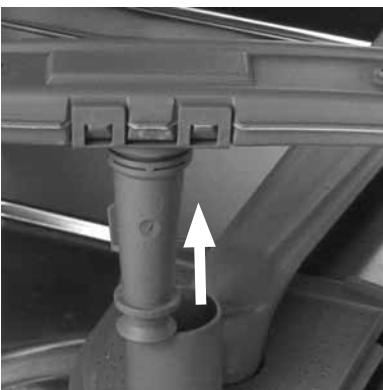
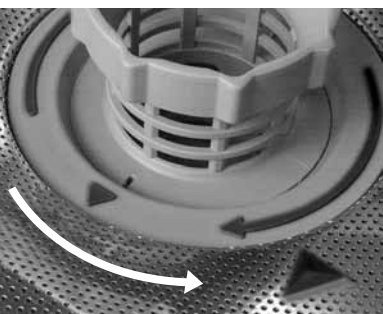

Figure 24



To open - turn counterclockwise.

To remove the top spray arm:

1. Remove the empty top rack from the dishwasher.
2. Turn the rack upside-down. The top spray arm is held in position by a locking nut as shown in Figure 21A. Turn the locking nut counter-clockwise 1/8 turn and remove it, as shown in Figure 21B to release the spray arm.
3. Remove the spray arm as shown in Figure 22.
4. Look for obstruction in the spray nozzles.
5. If the spray nozzles need cleaning, flush them under running water.

To reinstall the top spray arm:

1. Return the top spray arm to its installed position.
2. Return the locking nut to its installed position and turn it 1/8 turn clockwise.
3. Return the top rack to the top rack roller guides.

To remove the bottom spray arm:

1. Remove the empty bottom rack from the dishwasher tub.
2. Grasp and lift the bottom spray arm as shown in Figure 23.
3. Look for obstruction in the spray nozzles.
4. If the spray nozzles need cleaning, flush them under running water.

To reinstall the bottom spray arm:

1. Return the bottom spray arm to its installed position and press it so that it snaps into place.
2. Return the bottom rack to its installed position.

Check/Clean the Filter System

This dishwasher has a filter system that consists of a Large Object Trap/Cylinder Filter assembly and a Fine Filter. Select models have an additional Micro Filter. The filter system is located on the inside of your dishwasher under the lower rack and is easily accessible.

During normal use, the filter system is self-cleaning. You should occasionally inspect it for foreign objects and clean it when necessary.

⚠ CAUTION

To avoid injury, do not reach into the large object trap with your fingers. The large object trap could contain sharp objects.

This dishwasher has a filter system that consists of a Large Object Trap/Cylinder Filter assembly and a Fine Filter. The filter system is located on the inside of your dishwasher under the lower rack and is easily accessible.

During normal use, the filter system is self-cleaning. You should occasionally inspect it for foreign objects and clean it when necessary.

To Remove the Large Object Trap/Cylinder Filter Assembly:

1. Remove the bottom rack.
2. Grasp the assembly as shown in Figure 24 and turn it counter-clockwise 1/4 turn.
3. Lift out the assembly as shown in Figure 25.
4. Carefully examine the assembly. If you find debris in the Large Object Trap, turn it upside-down and gently tap it on a surface such as a countertop to dislodge and remove the debris. Flush the Cylinder Filter clean by holding it under running water.

To Remove the Fine Filter:

1. Lift the Fine Filter from the dishwasher floor as shown in Figure 26 A and flush it clean by holding it under running water.
2. Remove the Micro Filter as shown in Figure 26 B and flush it clean by holding it under

running water.

To reinstall the filter system:

1. Return the Fine Filter to its installed position.
2. Place the Large Object Trap/Cylinder Filter Assembly into its installed position in the dishwasher floor.
3. Turn the ring handle clockwise 1/4 turn until it is locked. The arrow on the ring handle and the arrow on the Fine Filter should point to each other, as shown by the circle in Figure 27.
4. Gently pull the ring handle to ensure that the assembly is locked into place.

ATTENTION

To avoid possible dishwasher damage, do not use harsh chemicals, abrasive cleaners, scouring pads (metal or plastic), or abrasive cloths/paper towels to clean your dishwasher's exterior door panel. Your dishwasher's exterior door panel can be damaged by doing so.

Figure 25



Large Object Trap/Cylinder Filter

Figure 26



Figure 27

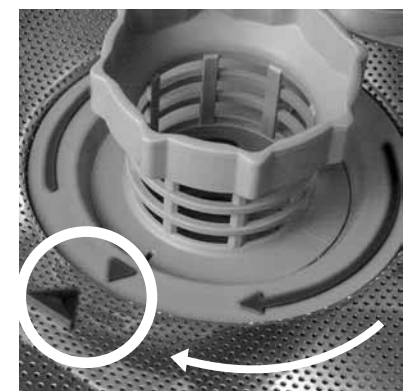

To close - turn clockwise.

Clean the Exterior Door Panel

Colored Doors

Use only a soft cloth that is lightly dampened with soapy water.

Stainless Steel Doors

Use a soft cloth with a non-abrasive cleaner (preferably a liquid spray) made for cleaning stainless steel. For the best results, apply the stainless steel cleaner to the cloth, then wipe the surface.

Clean the Door Gasket and Door Seal

Regularly clean the door gasket with a damp cloth to remove food particles and other debris. Also clean the door seal, located inside the dishwasher at the bottom of the door.

Wash Cycle Information

To save energy, this dishwasher has a “Smart Control” that automatically adjust the cycle based on soil loads and incoming water temperature. The “Smart Control” makes decisions that can cause the cycle time and water usage to adjust intermittently. The cycle times listed in the Use and Care manual are based on normal soil loads and 120°F incoming water and will vary based on your actual conditions.

SANITIZED

A dishwasher cycle that has the Sanitized symbol has been tested to meet very strict requirements of wash time and water temperature to ensure dishware and kitchenware sanitization. All cycles that meet the Sanitized requirements heat the water to a minimum of 156°F.

NOTE: If your household water supply is too hot, your dishwasher’s heating time may be reduced and the “Sanitized” light or symbol may not illuminate. Your Dishwasher Installation Manual has information on the recommended temperature for your household hot water supply.

Cycle Data

| | | SANITIZED Pots and Pans | SANITIZED Regular | Delicate/ Econo | Quick |
|------------------------------------|----------------------------|--------------------------------------|-----------------------------|--------------------|-------------|
| | Cycle Time (in minutes) | 135 | 119 | 80 | 30 |
| Water Consumption in gallons | Minimum | 6.1 | 2.3 | 3.1 | 3.3 |
| | Maximum | 7.2 | 5.7 | 4.2 | 3.3 |
| Water Consumption in liters | Minimum | 23.2 | 8.8 | 11.5 | 12.3 |
| | Maximum | 27.4 | 21.7 | 15.7 | 12.3 |
| Wash Temp °F | | <u>150-160°</u> | <u>122° - 131°</u> | <u>122°</u> | <u>113°</u> |
| Rinse Temp °F | | 156° | 156° | 156° | 122° |

Self Help

Dishwashers may occasionally exhibit problems that are unrelated to a malfunction of the dishwasher itself. The following information may help you with a dishwasher problem without your having to call a repair person.

Dishes do not dry

The rinse agent dispenser may be empty. Check the rinse-aid dispenser and refill it if necessary. Dishware drying can be accelerated and enhanced by opening the dishwasher door slightly and propping it open with the top rack.

Indicator light(s) do not come on

A fuse may have blown or a circuit breaker tripped. Check the fuse or circuit breaker at your fuse box/breaker box and replace the fuse or reset the breaker if necessary.

Dishwasher does not start

The dishwasher door may not be properly shut. Make certain the dishwasher door is shut and latched.

Dishwasher runs a long time

If the dishwasher completes the cycle, but the run time seems exceptionally long, it may be due to cold incoming water. Before starting the dishwasher, open the hot water faucet at the sink nearest the dishwasher. Run the water until it runs hot, then turn off the water and start the dishwasher.

Machine cycle does not advance to rinse

NOTE: The Installation Manual that came with your dishwasher will help you with the following instructions. The water supply line may be shut off. Check the water supply valve and open it if it's shut.

White spots left on dishes

More rinse agent is needed. Go to the Adding Detergent and Rinse Agent section of this manual for instructions on increasing the amount of rinse agent dispensed.

Water not pumped from dishwasher

Make certain the drain hose isn't kinked, clogged, or improperly installed. Make certain a portion of the drain hose is at least 20 inches above the dishwasher's enclosure floor (see the Installation Manual). Filters may be clogged. Make certain the filter system isn't clogged (see the Care and Maintenance section of this manual). The kitchen sink drain may be clogged; you may need a plumber rather than a serviceman for the dishwasher. If an air gap is installed at sink, it may be clogged.

Detergent dispenser cover will not shut

You may not be correctly shutting the detergent dispenser cover, or a cycle was not finished and should be cancelled. Go to the Adding Detergent and Rinse Agent section of this manual for instructions on shutting the detergent dispenser cover. Go to the Operating the Dishwasher section of this manual for instructions on canceling a cycle.

Streaks on glassware

Too much rinse agent is being dispensed. Go to the Adding Detergent and Rinse Agent section of this manual for instructions on decreasing the amount of rinse agent dispensed.

Rattling noises

Utensils may not be properly arranged.

Suds in dishwasher

You may have used the wrong type of dishwashing detergent. Use only automatic dishwasher detergents.

Unsatisfactory washing results

- Incorrect amount of detergent.
- Utensils incorrectly arranged or rack overloaded.
- Spray arm rotation blocked by utensils.
- Spray arm nozzles need cleaning.
- Filters not properly fitted into position.
- Unsuitable cycle selected.

Statement of Limited Product Warranty

Bosch Dishwashers

What this Warranty Covers & Who it Applies to: The limited warranty provided BSH Home Appliances ("Bosch") in this Statement of Limited Product Warranty applies only to Bosch dishwashers ("Product") sold to you, the first using purchaser, provided that the Product was purchased: (1) for your normal, household (non-commercial) use, and has in fact at all times only been used for normal household purposes; (2) new at retail (not a display, "as is", or previously returned model), and not for resale, or commercial use; and (3) within the United States or Canada, and has at all times remained within the country of original purchase. The warranties stated herein apply only to the first purchaser of the Product and are not transferable.

- Please make sure to return your registration card; while not necessary to effectuate warranty coverage, it is the best way for Bosch to notify you in the unlikely event of a safety notice or product recall.

How Long the Warranty Lasts: Bosch warrants that the Product is free from defects in materials and workmanship for a period of three hundred sixty five (365) days (i.e., 1 year) from the date of purchase. The foregoing timeline begins to run upon the date of purchase, and shall not be stalled, tolled, extended, or suspended, for any reason whatsoever. Labor and shipping costs are included in this basic coverage.

Extended Limited Warranty: Bosch also provides these additional limited warranties:

- **2 Year Limited Warranty:** Bosch will repair or replace any component that proves to be defective in materials or workmanship (excludes labor charges).
- **5 Year Limited Warranty on Electronics:** Bosch will repair or replace any Bosch microprocessor or printed circuit board if it proves to be defective in materials or workmanship (excludes labor charges).
- **5 Year Limited Warranty on Dish Racks:** Bosch will replace the upper or lower dish rack (excluding rack components), if the rack proves defective in materials or workmanship (excludes labor charges).
- **Lifetime Warranty against Stainless Steel Rust Through:** Bosch will replace your dishwasher with the same model or a current model that is substantially equivalent or better in functionality, if the inner liner should rust through (excludes labor charges). Bosch will replace the stainless steel door if the door should rust through (excludes labor charges).

The foregoing timeline begins to run upon the date of purchase, and shall not be stalled, tolled, extended, or suspended, for any reason whatsoever.

Repair/Replace as Your Exclusive Remedy: During this warranty period, Bosch or one of its authorized service providers will repair your Product without charge to you (subject to certain limitations stated herein) if your Product proves to have been manufactured with a defect in materials or workmanship. If reasonable attempts to repair the Product have been made without success, then Bosch will replace your Product (upgraded models may be available to you, in Bosch's sole discretion, for an additional charge). All removed parts and components shall become the property of Bosch at its sole option. All replaced and/or repaired parts shall assume the identity of the original part for purposes of this warranty and this warranty shall not be extended with respect to such parts. Bosch's sole liability and responsibility hereunder is to repair manufacturer-defective Product only, using a Bosch-authorized service provider during normal business hours. For safety and property damage concerns, Bosch highly recommends that you do not attempt to repair the Product yourself, or use an un-authorized servicer; Bosch will have no responsibility or liability for repairs or work performed by a non-authorized servicer. If you choose to have someone other than an authorized service provider work on your Product, THIS WARRANTY WILL AUTOMATICALLY BECOME NULL AND VOID. Authorized service providers are those persons or companies that have been specially trained on Bosch products, and who possess, in Bosch's opinion, a superior reputation for customer service and technical ability (note that they are independent entities and are *not* agents, partners, affiliates or representatives of Bosch). Notwithstanding the foregoing, Bosch will not incur any liability, or have responsibility, for the Product if it is located in a remote area (more than 100 miles from an authorized service provider) or is reasonably

inaccessible, hazardous, threatening, or treacherous locale, surroundings, or environment; in any such event, if you request, Bosch would still pay for labor and parts and ship the parts to the nearest authorized service provider, but you would still be fully liable and responsible for any travel time or other special charges by the service company, assuming they agree to make the service call.

Out of Warranty Product: Bosch is under no obligation, at law or otherwise, to provide you with any concessions, including repairs, pro-rates, or Product replacement, once this warranty has expired.

Warranty Exclusions: The warranty coverage described herein excludes all defects or damage that are not the direct fault of Bosch, including without limitation, one or more of the following: (1) use of the Product in anything other than its normal, customary and intended manner (including without limitation, any form of commercial use, use or storage of an indoor product outdoors, use of the Product in conjunction with air or water-going vessels); (2) any party's willful misconduct, negligence, misuse, abuse, accidents, neglect, improper operation, failure to maintain, improper or negligent installation, tampering, failure to follow operating instructions, mishandling, unauthorized service (including self-performed "fixing" or exploration of the appliance's internal workings); (3) adjustment, alteration or modification of any kind; (4) a failure to comply with any applicable state, local, city, or county electrical, plumbing and/or building codes, regulations, or laws, including failure to install the product in strict conformity with local fire and building codes and regulations; (5) ordinary wear and tear, spills of food, liquid, grease accumulations, or other substances that accumulate on, in, or around the Product; and (6) any external, elemental and/or environmental forces and factors, including without limitation, rain, wind, sand, floods, fires, mud slides, freezing temperatures, excessive moisture or extended exposure to humidity, lightning, power surges, structural failures surrounding the appliance, and acts of God. In no event shall Bosch have any liability or responsibility whatsoever for damage to surrounding property, including cabinetry, floors, ceilings, and other structures or objects around the Product. Also excluded from this warranty are scratches, nicks, minor dents, and cosmetic damages on external surfaces and exposed parts; Products on which the serial numbers have been altered, defaced, or removed; service visits to teach you how to use the Product, or visits where there is nothing wrong with the Product; correction of installation problems (you are solely responsible for any structure and setting for the Product, including all electrical, plumbing or other connecting facilities, for proper foundation/flooring, and for any alterations including without limitation cabinetry, walls, floors, shelving, etc.); and resetting of breakers or fuses. **TO THE EXTENT ALLOWED BY LAW, THIS WARRANTY SETS OUT YOUR EXCLUSIVE REMEDIES WITH RESPECT TO PRODUCT, WHETHER THE CLAIM ARISES IN CONTRACT OR TORT (INCLUDING STRICT LIABILITY, OR NEGLIGENCE) OR OTHERWISE. THIS WARRANTY IS IN LIEU OF ALL OTHER WARRANTIES, WHETHER EXPRESS OR IMPLIED. ANY WARRANTY IMPLIED BY LAW, WHETHER FOR MERCHANTABILITY OR FITNESS FOR A PARTICULAR PURPOSE, OR OTHERWISE, SHALL BE EFFECTIVE ONLY FOR THE PERIOD THAT THIS EXPRESS LIMITED WARRANTY IS EFFECTIVE. IN NO EVENT WILL THE MANUFACTURER BE LIABLE FOR CONSEQUENTIAL, SPECIAL, INCIDENTAL, INDIRECT, "BUSINESS LOSS", AND/OR PUNITIVE DAMAGES, LOSSES, OR EXPENSES, INCLUDING WITHOUT LIMITATION TIME AWAY FROM WORK, HOTELS AND/OR RESTAURANT MEALS, REMODELLING EXPENSES IN EXCESS OF DIRECT DAMAGES WHICH ARE DEFINITELY CAUSED EXCLUSIVELY BY BOSCH, OR OTHERWISE. SOME STATES DO NOT ALLOW THE EXCLUSION OR LIMITATION OF INCIDENTAL OR CONSEQUENTIAL DAMAGES, AND SOME STATES DO NOT ALLOW LIMITATIONS ON HOW LONG AN IMPLIED WARRANTY LASTS, SO THE ABOVE LIMITATIONS MAY NOT APPLY TO YOU. THIS WARRANTY GIVES YOU SPECIFIC LEGAL RIGHTS, AND YOU MAY ALSO HAVE OTHER RIGHTS WHICH VARY FROM STATE TO STATE. No attempt to alter, modify or amend this warranty shall be effective unless authorized in writing by an officer of BSH.**

How to Obtain Warranty Service: TO OBTAIN WARRANTY SERVICE FOR YOUR PRODUCT, YOU SHOULD CONTACT THE NEAREST BOSCH AUTHORIZED SERVICE CENTER, OR CALL 800-944-2904, or write Bosch at: BSH Home Appliances - 5551 McFadden Avenue, Huntington Beach, CA 92649 /

Customer Service

Your Bosch dishwasher requires no special care other than that described in the Care and Maintenance section. If you are having a problem with your dishwasher, before calling for service please refer to the Self Help section. If service is necessary, contact your dealer or installer or an authorized service center. **Do not attempt to repair the appliance yourself.** Any work performed by unauthorized personnel may void the warranty.

If you are having a problem with your Bosch dishwasher and are not pleased with the service you have received, please take the following steps (in the order listed below) until the problem is corrected to your satisfaction:

1. Contact your installer or the Bosch Authorized Service Contractor in your area.
2. E-mail us from the customer service section of our website, www.boschappliances.com.
3. Write us at the address below:

BSH Home Appliances, Corporation
 5551 McFadden Avenue
 Huntington Beach, CA 92649

4. Call us at 1-800-944-2904.

Please be sure to include your model information listed below as well as an explanation of the problem and the date it originated.

You will find the model and serial number information on the label located on the right edge of the dishwasher door as shown in Figure 28.

Also, if you are writing, please include a daytime phone number where you can be reached.

Please make a copy of your invoice and keep it with this manual. The customer must show proof of purchase to obtain warranty service.

Your Model Information:

- Model Number _____
- Serial Number _____
- Date Purchased _____
- Date Installed _____



CAUTION

Removing any cover or pulling the dishwasher from the cabinet can expose hot water connections, electrical power and sharp edges or points.

Figure 28



Model and Serial Number Label

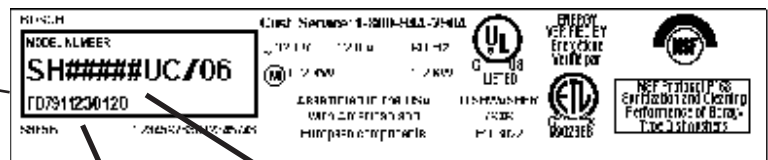

Serial Number Model Number